

CGH40006P

6 W, RF Power GaN HEMT

Cree's CGH40006P is an unmatched, gallium nitride (GaN) high electron mobility transistor (HEMT). The CGH40006P, operating from a 28 volt rail, offers a general purpose, broadband solution to a variety of RF and microwave applications. GaN HEMTs offer high efficiency, high gain and wide bandwidth capabilities making the CGH40006P ideal for linear and compressed amplifier circuits. The transistor is available in a solder-down, pill package.

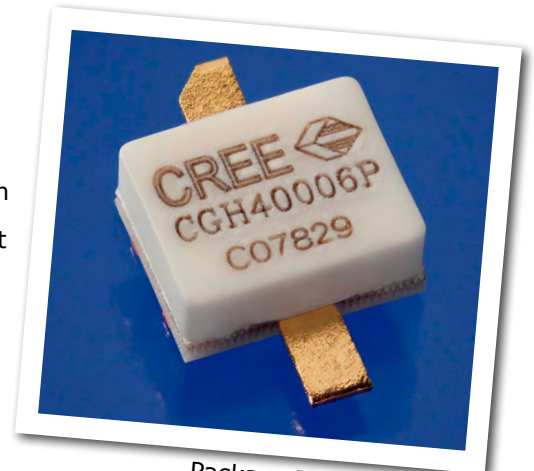

Package Types: 440109
PN's: CGH40006P

FEATURES

- Up to 6 GHz Operation
- 13 dB Small Signal Gain at 2.0 GHz
- 11 dB Small Signal Gain at 6.0 GHz
- 8 W typical at $P_{IN} = 32$ dBm
- 65 % Efficiency at $P_{IN} = 32$ dBm
- 28 V Operation

APPLICATIONS

- 2-Way Private Radio
- Broadband Amplifiers
- Cellular Infrastructure
- Test Instrumentation
- Class A, AB, Linear amplifiers suitable for OFDM, W-CDMA, EDGE, CDMA waveforms



Large Signal Models Available for SiC & GaN



Absolute Maximum Ratings (not simultaneous) at 25 °C Case Temperature

Parameter	Symbol	Rating	Units	Conditions
Drain-Source Voltage	V_{DS}	84	Volts	25 °C
Gate-to-Source Voltage	V_{GS}	-10, +2	Volts	25 °C
Storage Temperature	T_{STG}	-65, +150	°C	
Operating Junction Temperature	T_J	225	°C	
Maximum Forward Gate Current	I_{GMAX}	2.1	mA	25 °C
Maximum Drain Current ¹	I_{DMAX}	0.75	A	25 °C
Soldering Temperature ²	T_S	245	°C	
Thermal Resistance, Junction to Case ³	$R_{\theta JC}$	9.5	°C/W	85 °C
Case Operating Temperature ³	T_C	-40, +150	°C	30 seconds

Note:

¹ Current limit for long term, reliable operation

² Refer to the Application Note on soldering at www.cree.com/products/wireless_appnotes.asp

³ Measured for the CGH40006P at $P_{DISS} = 8$ W.

Electrical Characteristics ($T_C = 25$ °C)

Characteristics	Symbol	Min.	Typ.	Max.	Units	Conditions
DC Characteristics¹						
Gate Threshold Voltage	$V_{GS(th)}$	-3.8	-3.0	-2.3	V_{DC}	$V_{DS} = 10$ V, $I_D = 2.1$ mA
Gate Quiescent Voltage	$V_{GS(Q)}$	-	-2.7	-	V_{DC}	$V_{DS} = 28$ V, $I_D = 100$ mA
Saturated Drain Current	I_{DS}	1.7	2.1	-	A	$V_{DS} = 6.0$ V, $V_{GS} = 2.0$ V
Drain-Source Breakdown Voltage	V_{BR}	120	-	-	V_{DC}	$V_{GS} = -8$ V, $I_D = 2.1$ mA
RF Characteristics² ($T_C = 25$ °C, $F_0 = 2.0$ GHz unless otherwise noted)						
Small Signal Gain	G_{SS}	11.5	13	-	dB	$V_{DD} = 28$ V, $I_{DQ} = 100$ mA
Power Output at $P_{IN} = 32$ dBm	P_{OUT}	7.0	9	-	W	$V_{DD} = 28$ V, $I_{DQ} = 100$ mA
Drain Efficiency ³	η	53	65	-	%	$V_{DD} = 28$ V, $I_{DQ} = 100$ mA, $P_{IN} = 32$ dBm
Output Mismatch Stress	VSWR	-	-	10 : 1	Ψ	No damage at all phase angles, $V_{DD} = 28$ V, $I_{DQ} = 100$ mA, $P_{IN} = 32$ dBm
Dynamic Characteristics						
Input Capacitance	C_{GS}	-	3.0	-	pF	$V_{DS} = 28$ V, $V_{GS} = -8$ V, $f = 1$ MHz
Output Capacitance	C_{DS}	-	1.1	-	pF	$V_{DS} = 28$ V, $V_{GS} = -8$ V, $f = 1$ MHz
Feedback Capacitance	C_{GD}	-	0.1	-	pF	$V_{DS} = 28$ V, $V_{GS} = -8$ V, $f = 1$ MHz

Notes:

¹ Measured on wafer prior to packaging.

² Measured in CGH40006P-TB.

³ Drain Efficiency = P_{OUT} / P_{DC}



Typical Performance

Small Signal Gain vs Frequency at 28 V of the CGH40006P in the CGH40006P-TB

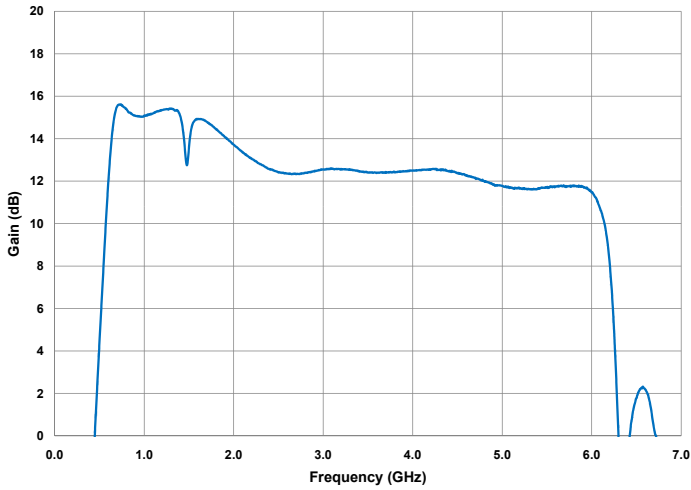

Input & Output Return Losses vs Frequency at 28 V of the CGH40006P in the CGH40006P-TB

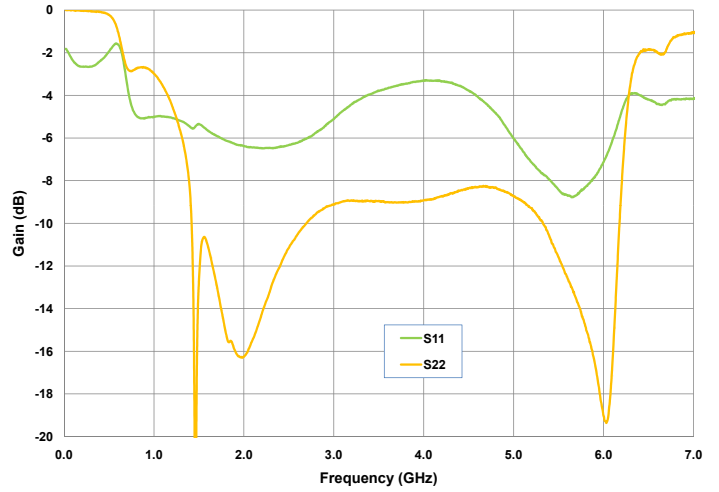

Small Signal Gain vs Frequency at 20 V of the CGH40006P in the CGH40006P-TB

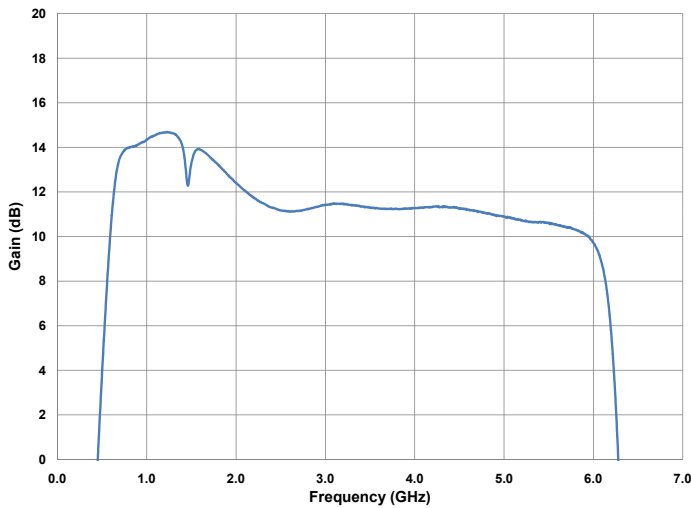

Input & Output Return Losses vs Frequency at 20 V of the CGH40006P in the CGH40006P-TB

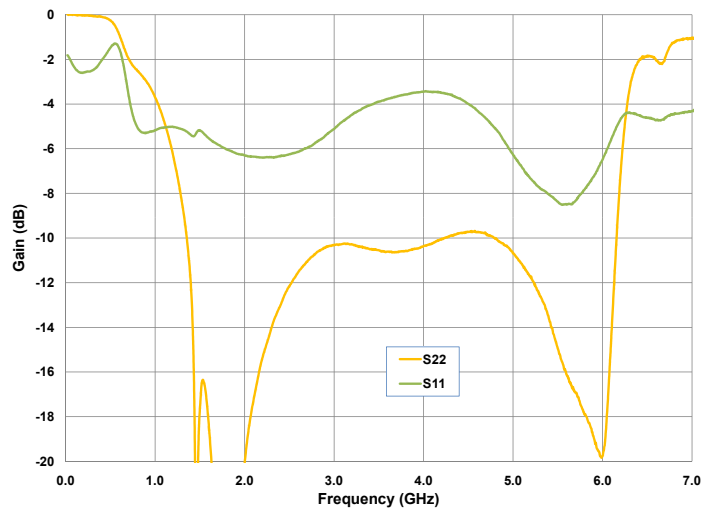

Typical Performance

Power Gain vs Output Power as a Function of Frequency of the CGH40006P in the CGH40006P-TB
 $V_{DD} = 28\text{ V}$, $I_{DQ} = 100\text{ mA}$

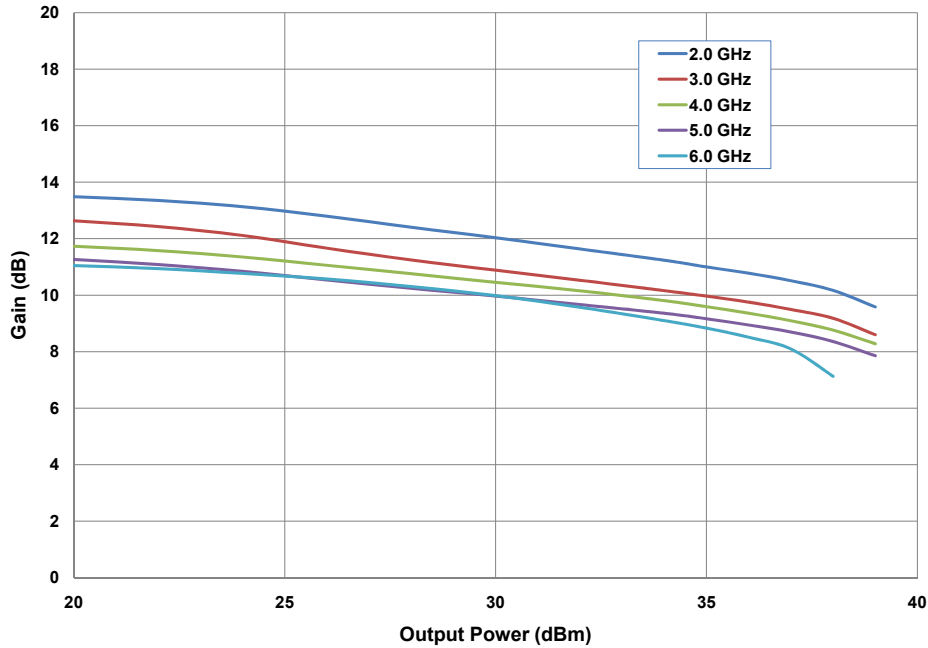

Drain Efficiency vs Output Power as a Function of Frequency of the CGH40006P in the CGH40006P-TB
 $V_{DD} = 28\text{ V}$, $I_{DQ} = 100\text{ mA}$

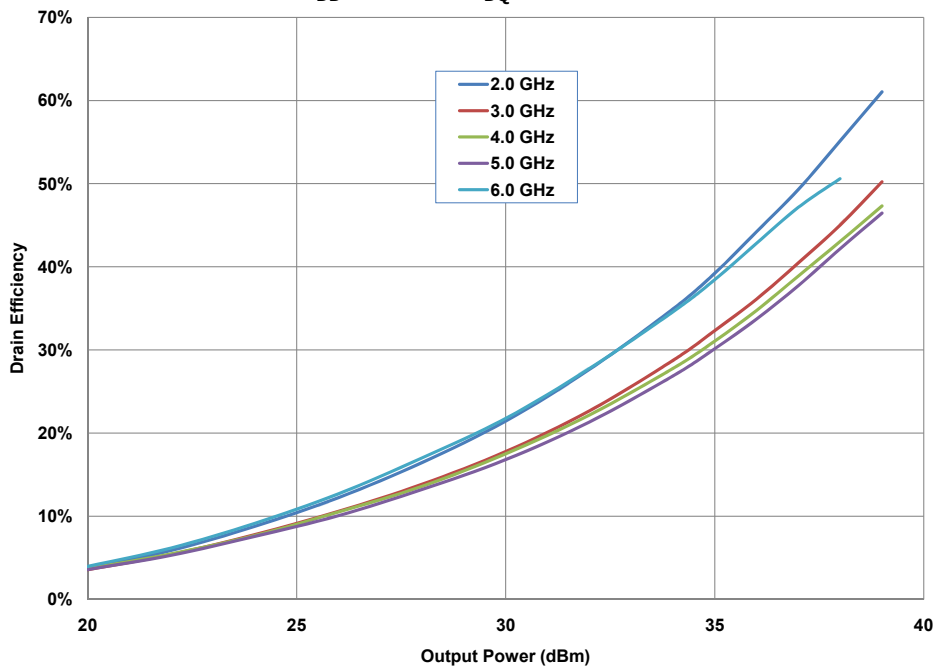



Typical Performance

Power Gain vs Frequency of the CGH40006P in the CGH40006P-TB at $P_{IN} = 32$ dBm, $V_{DD} = 28$ V

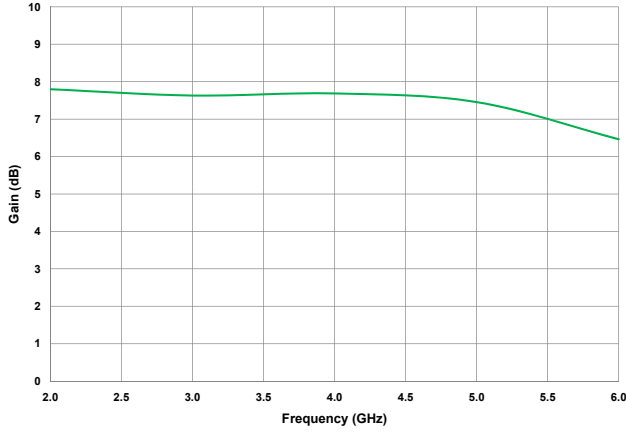

Power Gain vs Frequency of the CGH40006P in the CGH40006P-TB at $P_{IN} = 30$ dBm, $V_{DD} = 20$ V

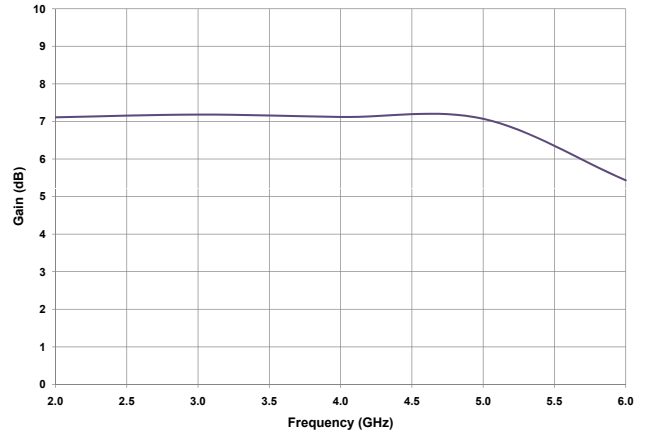

Output Power vs Frequency of the CGH40006P in the CGH40006P-TB at $P_{IN} = 32$ dBm, $V_{DD} = 28$ V

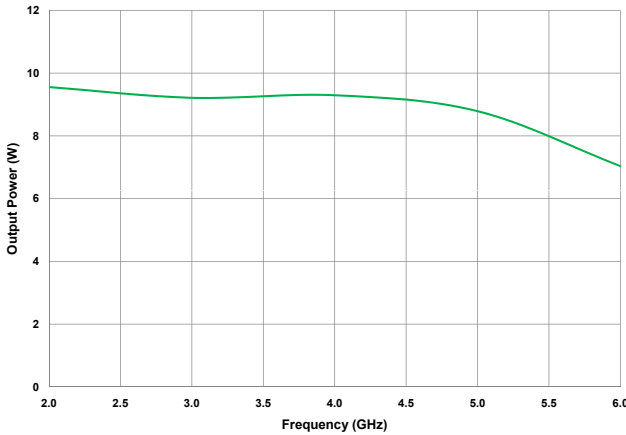

Output Power vs Frequency of the CGH40006P in the CGH40006P-TB at $P_{IN} = 30$ dBm, $V_{DD} = 20$ V

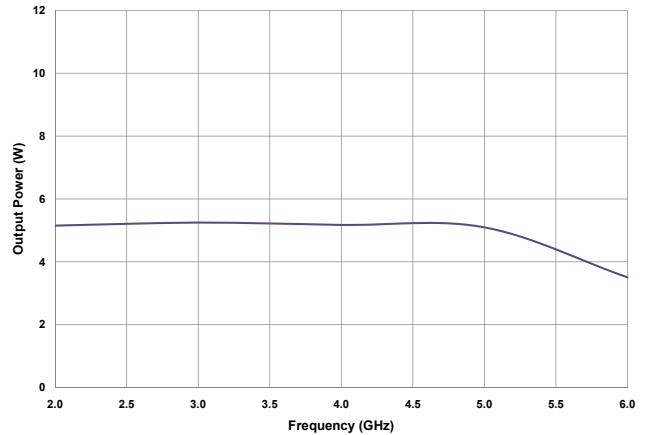

Drain Efficiency vs Frequency of the CGH40006P in the CGH40006P-TB at $P_{IN} = 32$ dBm, $V_{DD} = 28$ V

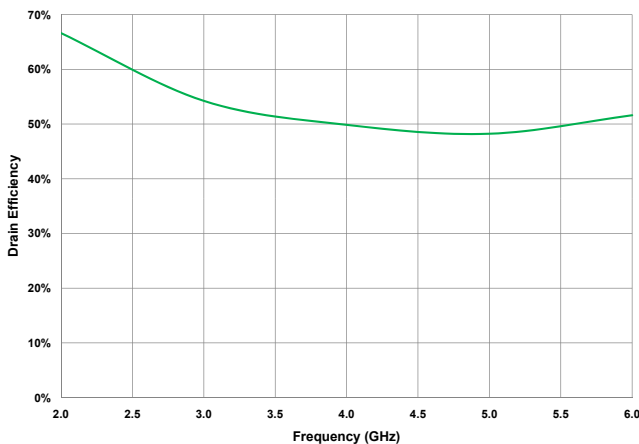

Drain Efficiency vs Frequency of the CGH40006P in the CGH40006P-TB at $P_{IN} = 30$ dBm, $V_{DD} = 20$ V

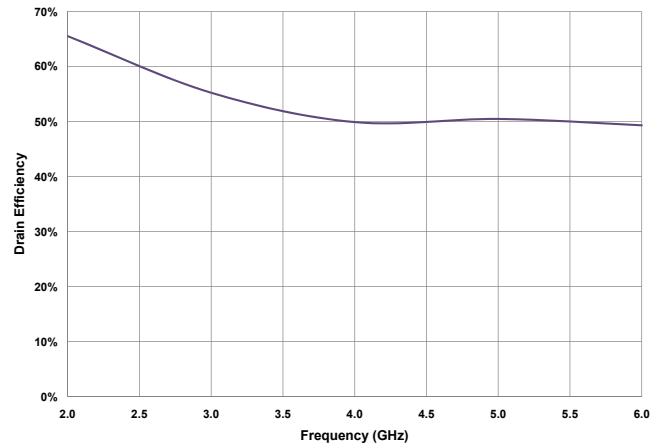

Typical Performance

Third Order Intermodulation Distortion vs Average Output Power as a Function of Frequency of the CGH40006P in the CGH40006P-TB
 $V_{DD} = 28\text{ V}$, $I_{DQ} = 60\text{ mA}$

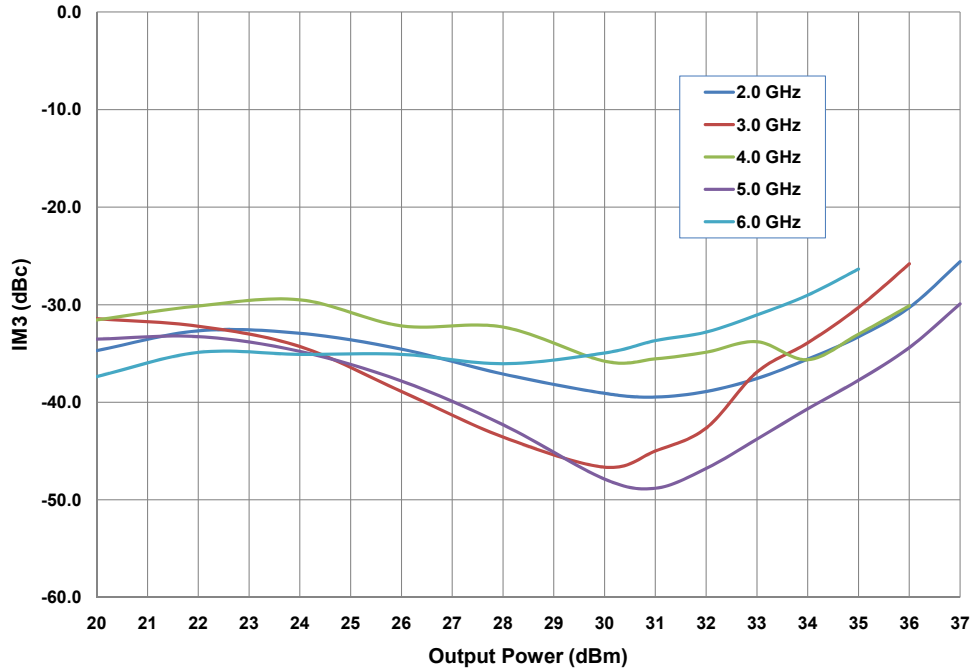

Simulated Maximum Available Gain and K Factor of the CGH40006P
 $V_{DD} = 28\text{ V}$, $I_{DQ} = 100\text{ mA}$

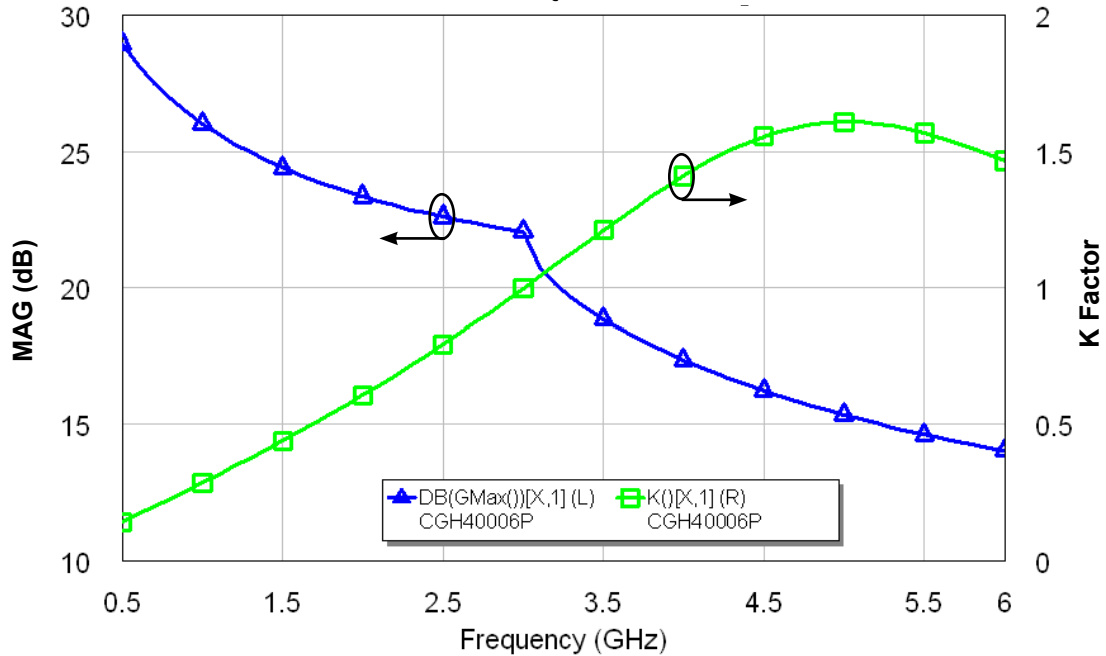

Typical Noise Performance

Simulated Minimum Noise Figure and Noise Resistance vs Frequency of the CGH40006P
 $V_{DD} = 28\text{ V}$, $I_{DQ} = 100\text{ mA}$

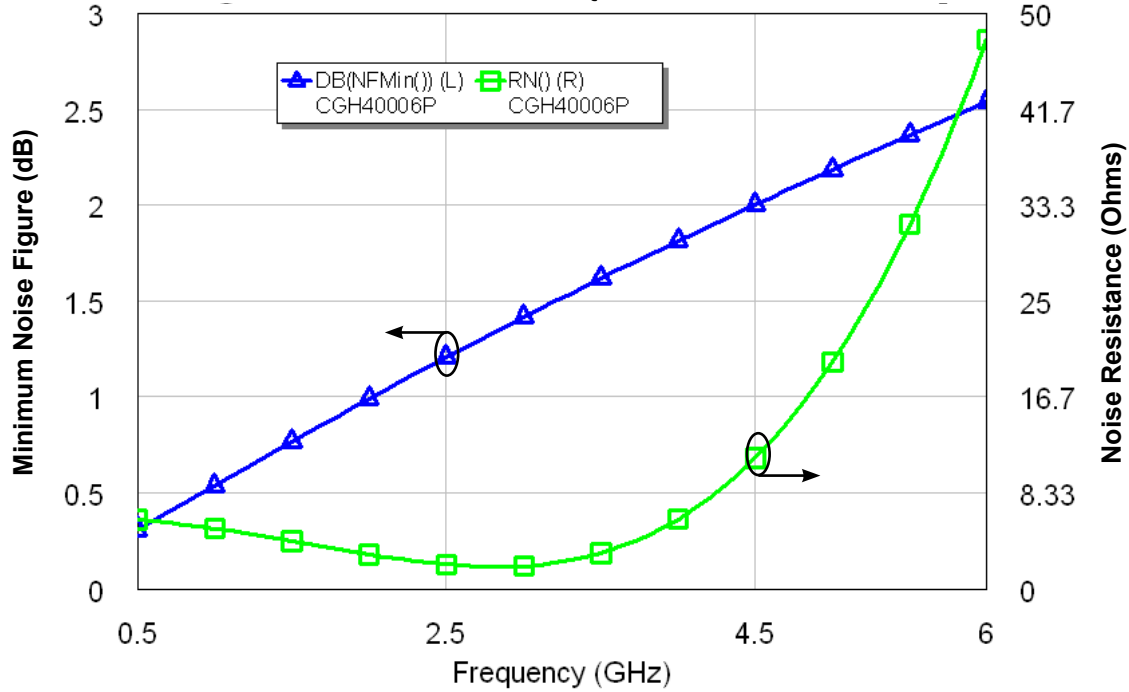

Electrostatic Discharge (ESD) Classifications

Parameter	Symbol	Class	Test Methodology
Human Body Model	HBM	1A > 250 V	JEDEC JESD22 A114-D
Charge Device Model	CDM	1 < 200 V	JEDEC JESD22 C101-C

Source and Load Impedances

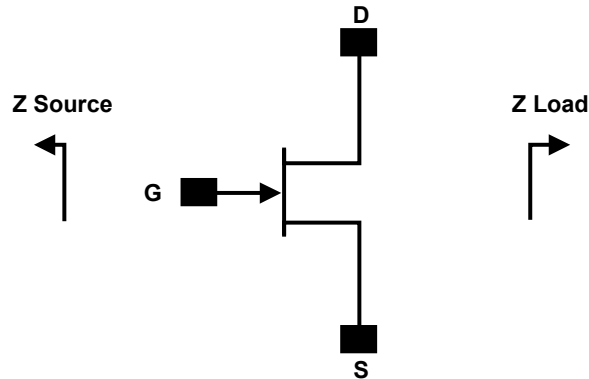

Frequency (MHz)	Z Source	Z Load
1000	13.78 + j6.9	61.5 + j47.4
2000	4.78 + j1.78	19.4 + j39.9
3000	2.57 - j6.94	12.57 + j23.1
4000	3.54 - j14.86	9.44 + j11.68
5000	4.42 - j25.8	9.78 + j4.85
6000	7.1 - j42.7	9.96 - j4.38

Note 1. $V_{DD} = 28V$, $I_{DQ} = 100mA$ in the 440109 package.

Note 2. Optimized for power gain, P_{SAT} and PAE.

Note 3. When using this device at low frequency, series resistors should be used to maintain amplifier stability.

CGH40006P Power Dissipation De-rating Curve

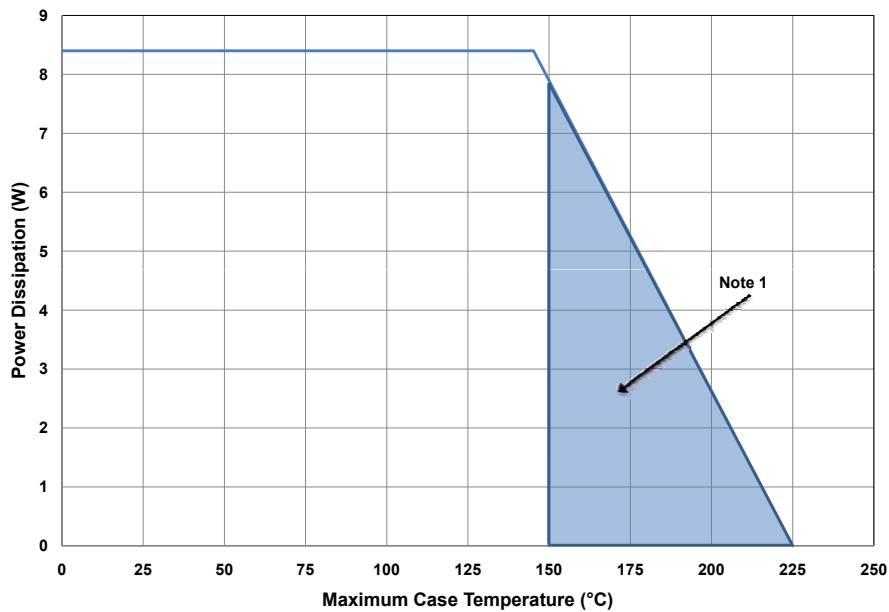

Note 1. Area exceeds Maximum Case Operating Temperature (See Page 2).

CGH40006P-TB Demonstration Amplifier Circuit Bill of Materials

Designator	Description	Qty
R1	RES, AIN, 0505, 470 Ohms ($\leq 5\%$ tolerance)	1
R2	RES, AIN, 0505, 10 Ohms ($\leq 5\%$ tolerance)	1
R3	RES, AIN, 0505, 150 Ohms ($\leq 5\%$ tolerance)	1
C1	CAP, 2.0 pF +/-0.1 pF, 0603, ATC 600S	1
C2	CAP, 4.7 pF +/-0.1 pF, 0603, ATC 600S	1
C10	CAP, 3.6 pF +/-0.1 pF, 0603, ATC 600S	1
C4,C11	CAP, 8.2 pF +/-0.25, 0603, ATC 600S	2
C6,C13	CAP, 470 pF +/-5%, 0603, 100 V	2
C7,C14	CAP, 33000 pF, CER, 100V, X7R, 0805	2
C8	CAP, 10 uf, 16V, SMT, TANTALUM	1
C15	CAP, 1.0 uF +/-10%, CER, 100V, X7R, 1210	1
C16	CAP, 33 uF, 100V, ELECT, FK, SMD	1
J3,J4	CONN, SMA, STR, PANEL, JACK, RECP	2
J1	HEADER RT>PLZ .1CEN LK 5POS	1
-	PCB, RO5880, 20 MIL	1
Q1	CGH40006P	1

CGH40006P-TB Demonstration Amplifier Circuit

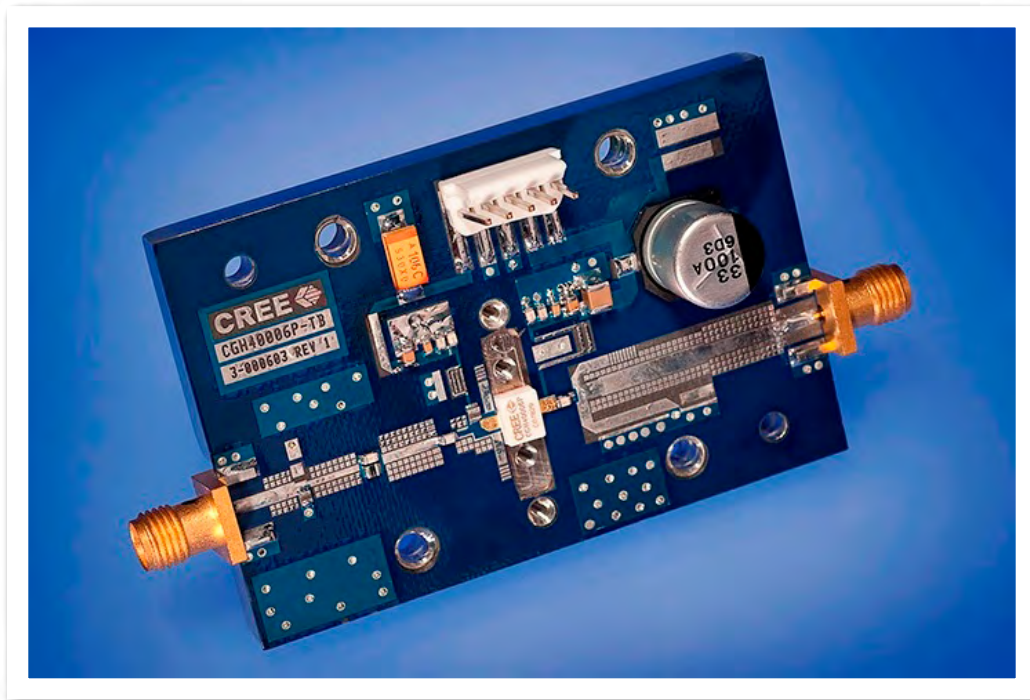

CGH40006P-TB Demonstration Amplifier Circuit Schematic

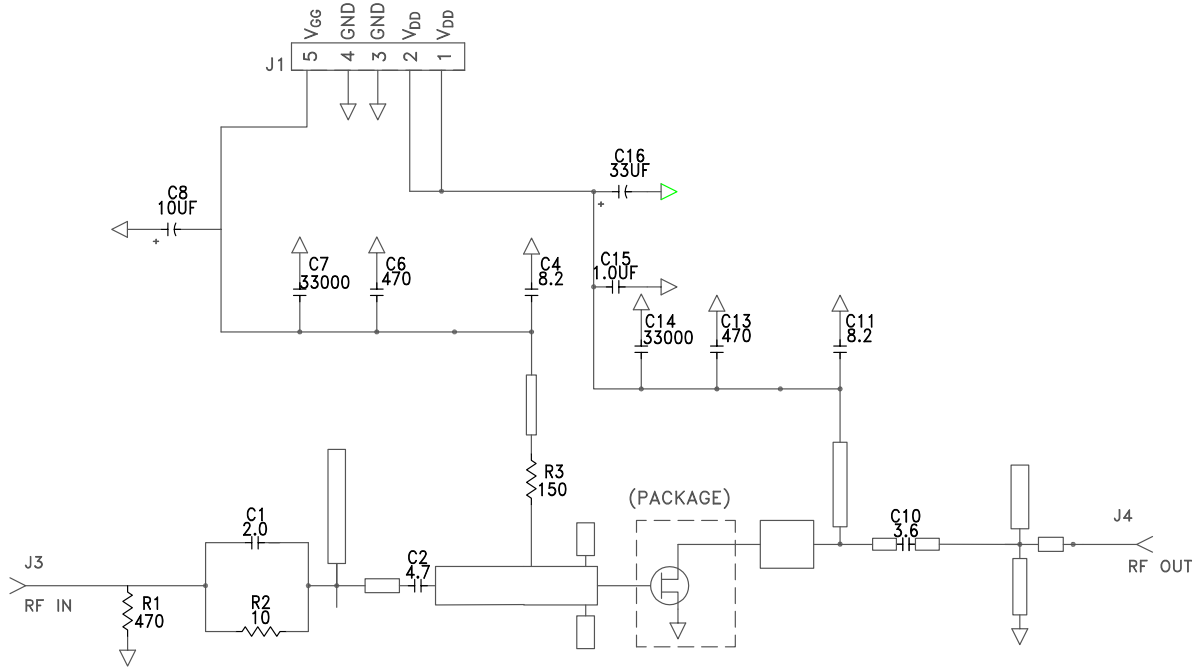

CGH40006P-TB Demonstration Amplifier Circuit Outline

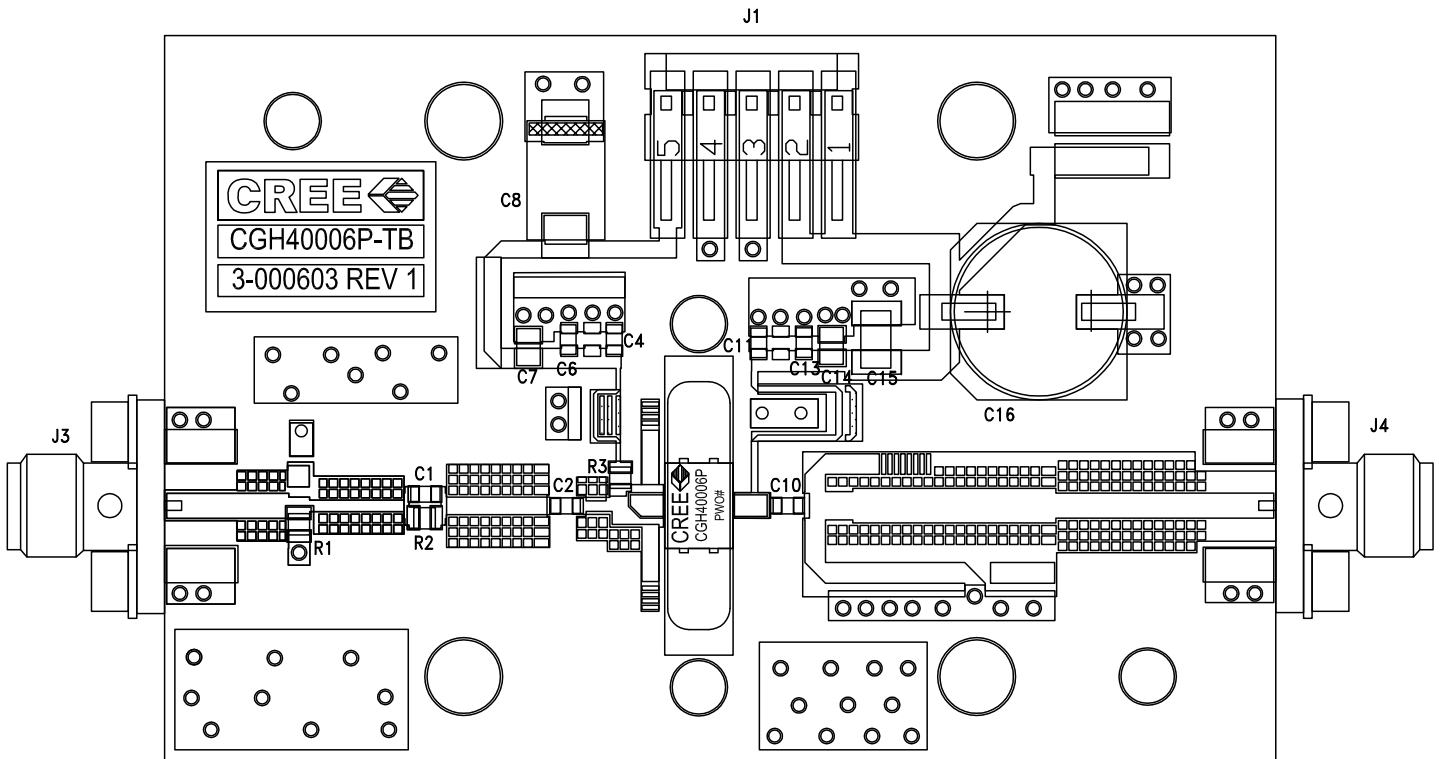



Typical Package S-Parameters for CGH40006P
(Small Signal, $V_{DS} = 28\text{ V}$, $I_{DQ} = 100\text{ mA}$, angle in degrees)

Frequency	Mag S11	Ang S11	Mag S21	Ang S21	Mag S12	Ang S12	Mag S22	Ang S22
500 MHz	0.905	-96.56	18.30	120.62	0.023	35.87	0.456	-52.76
600 MHz	0.889	-107.98	16.39	113.31	0.025	29.63	0.429	-58.98
700 MHz	0.877	-117.55	14.76	106.99	0.026	24.39	0.408	-64.31
800 MHz	0.867	-125.66	13.37	101.43	0.027	19.92	0.393	-68.96
900 MHz	0.860	-132.61	12.19	96.46	0.028	16.05	0.381	-73.11
1.0 GHz	0.854	-138.66	11.18	91.94	0.028	12.66	0.374	-76.87
1.1 GHz	0.849	-143.98	10.31	87.79	0.028	9.64	0.368	-80.34
1.2 GHz	0.845	-148.73	9.56	83.92	0.028	6.92	0.366	-83.57
1.3 GHz	0.842	-153.01	8.90	80.29	0.028	4.46	0.365	-86.61
1.4 GHz	0.839	-156.90	8.33	76.84	0.028	2.22	0.365	-89.49
1.5 GHz	0.837	-160.49	7.82	73.56	0.028	0.15	0.367	-92.24
1.6 GHz	0.835	-163.81	7.37	70.40	0.028	-1.75	0.369	-94.88
1.7 GHz	0.833	-166.92	6.96	67.36	0.028	-3.51	0.373	-97.43
1.8 GHz	0.832	-169.85	6.60	64.41	0.028	-5.15	0.376	-99.88
1.9 GHz	0.830	-172.62	6.27	61.54	0.028	-6.67	0.381	-102.27
2.0 GHz	0.829	-175.27	5.98	58.74	0.028	-8.08	0.386	-104.58
2.1 GHz	0.828	-177.81	5.71	56.00	0.028	-9.40	0.391	-106.84
2.2 GHz	0.827	179.75	5.46	53.32	0.027	-10.61	0.396	-109.04
2.3 GHz	0.826	177.38	5.24	50.68	0.027	-11.73	0.401	-111.19
2.4 GHz	0.825	175.07	5.03	48.09	0.027	-12.77	0.407	-113.29
2.5 GHz	0.824	172.82	4.84	45.53	0.027	-13.71	0.412	-115.36
2.6 GHz	0.823	170.61	4.67	43.00	0.026	-14.57	0.418	-117.38
2.7 GHz	0.821	168.44	4.51	40.50	0.026	-15.34	0.423	-119.36
2.8 GHz	0.820	166.30	4.36	38.02	0.026	-16.02	0.428	-121.32
2.9 GHz	0.819	164.18	4.22	35.57	0.026	-16.62	0.434	-123.24
3.0 GHz	0.818	162.08	4.09	33.13	0.026	-17.13	0.439	-125.13
3.2 GHz	0.816	157.91	3.85	28.31	0.025	-17.89	0.449	-128.84
3.4 GHz	0.813	153.76	3.65	23.53	0.025	-18.30	0.458	-132.46
3.6 GHz	0.810	149.58	3.47	18.78	0.025	-18.38	0.467	-136.00
3.8 GHz	0.807	145.35	3.31	14.05	0.024	-18.13	0.474	-139.48
4.0 GHz	0.804	141.05	3.18	9.32	0.024	-17.60	0.481	-142.91
4.2 GHz	0.801	136.66	3.05	4.57	0.024	-16.82	0.488	-146.30
4.4 GHz	0.797	132.15	2.94	-0.20	0.025	-15.89	0.493	-149.67
4.6 GHz	0.793	127.50	2.85	-5.01	0.025	-14.87	0.497	-153.02
4.8 GHz	0.789	122.70	2.76	-9.86	0.026	-13.89	0.500	-156.37
5.0 GHz	0.785	117.72	2.68	-14.79	0.027	-13.04	0.503	-159.74
5.2 GHz	0.780	112.55	2.62	-19.78	0.029	-12.42	0.504	-163.14
5.4 GHz	0.776	107.17	2.55	-24.86	0.030	-12.13	0.505	-166.59
5.6 GHz	0.772	101.58	2.50	-30.03	0.032	-12.22	0.504	-170.10
5.8 GHz	0.768	95.76	2.44	-35.30	0.035	-12.75	0.503	-173.70
6.0 GHz	0.764	89.70	2.40	-40.69	0.037	-13.73	0.501	-177.41

Download this s-parameter file in ".s2p" format at http://www.cree.com/products/wireless_s-parameters.asp

Product Dimensions CGH40006P (Package Type — 440109)

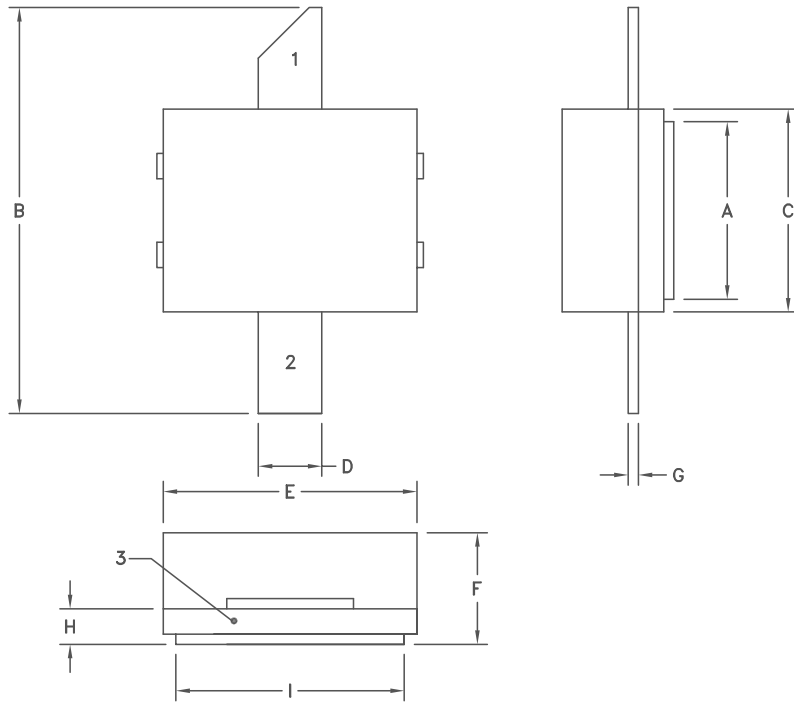

NOTES: (UNLESS OTHERWISE SPECIFIED)

1. INTERPRET DRAWING IN ACCORDANCE WITH ANSI Y14.5M-1982 DIMENSIONING AND TOLERANCING.
2. CONTROLLING DIMENSION: INCH.

DIM	INCHES		MILLIMETERS	
	MIN	MAX	MIN	MAX
A	.135	.145	3.43	3.68
B	.315	.325	8.00	8.26
C	.155	.165	3.94	4.19
D	.045	.055	1.14	1.40
E	.195	.205	4.95	5.21
F	.090	.110	2.29	2.79
G	.007	.009	.178	0.23
H	.026	.030	.660	.762
I	.175	.185	4.45	4.70

PIN 1. GATE
 PIN 2. DRAIN
 PIN 3. SOURCE



Disclaimer

Specifications are subject to change without notice. Cree, Inc. believes the information contained within this data sheet to be accurate and reliable. However, no responsibility is assumed by Cree for any infringement of patents or other rights of third parties which may result from its use. No license is granted by implication or otherwise under any patent or patent rights of Cree. Cree makes no warranty, representation or guarantee regarding the suitability of its products for any particular purpose. "Typical" parameters are the average values expected by Cree in large quantities and are provided for information purposes only. These values can and do vary in different applications and actual performance can vary over time. All operating parameters should be validated by customer's technical experts for each application. Cree products are not designed, intended or authorized for use as components in applications intended for surgical implant into the body or to support or sustain life, in applications in which the failure of the Cree product could result in personal injury or death or in applications for planning, construction, maintenance or direct operation of a nuclear facility.

For more information, please contact:

Cree, Inc.
4600 Silicon Drive
Durham, North Carolina, USA 27703
www.cree.com/wireless

Sarah Miller
Marketing & Export
Cree, RF Components
1.919.407.5302

Ryan Baker
Marketing
Cree, Wireless Devices
1.919.287.7816

Tom Dekker
Sales Director
Cree, Wireless Devices
1.919.313.5639

Компания «Океан Электроники» предлагает заключение долгосрочных отношений при поставках импортных электронных компонентов на взаимовыгодных условиях!

Наши преимущества:

- Поставка оригинальных импортных электронных компонентов напрямую с производств Америки, Европы и Азии, а так же с крупнейших складов мира;
- Широкая линейка поставок активных и пассивных импортных электронных компонентов (более 30 млн. наименований);
- Поставка сложных, дефицитных, либо снятых с производства позиций;
- Оперативные сроки поставки под заказ (от 5 рабочих дней);
- Экспресс доставка в любую точку России;
- Помощь Конструкторского Отдела и консультации квалифицированных инженеров;
- Техническая поддержка проекта, помощь в подборе аналогов, поставка прототипов;
- Поставка электронных компонентов под контролем ВП;
- Система менеджмента качества сертифицирована по Международному стандарту ISO 9001;
- При необходимости вся продукция военного и аэрокосмического назначения проходит испытания и сертификацию в лаборатории (по согласованию с заказчиком);
- Поставка специализированных компонентов военного и аэрокосмического уровня качества (Xilinx, Altera, Analog Devices, Intersil, Interpoint, Microsemi, Actel, Aeroflex, Peregrine, VPT, Syfer, Eurofarad, Texas Instruments, MS Kennedy, Miteq, Cobham, E2V, MA-COM, Hittite, Mini-Circuits, General Dynamics и др.);

Компания «Океан Электроники» является официальным дистрибьютором и эксклюзивным представителем в России одного из крупнейших производителей разъемов военного и аэрокосмического назначения «JONHON», а так же официальным дистрибьютором и эксклюзивным представителем в России производителя высокотехнологичных и надежных решений для передачи СВЧ сигналов «FORSTAR».



JONHON

«JONHON» (основан в 1970 г.)

Разъемы специального, военного и аэрокосмического назначения:

(Применяются в военной, авиационной, аэрокосмической, морской, железнодорожной, горно- и нефтедобывающей отраслях промышленности)

«FORSTAR» (основан в 1998 г.)

ВЧ соединители, коаксиальные кабели, кабельные сборки и микроволновые компоненты:

(Применяются в телекоммуникациях гражданского и специального назначения, в средствах связи, РЛС, а так же военной, авиационной и аэрокосмической отраслях промышленности).



Телефон: 8 (812) 309-75-97 (многоканальный)

Факс: 8 (812) 320-03-32

Электронная почта: ocean@oceanchips.ru

Web: <http://oceanchips.ru/>

Адрес: 198099, г. Санкт-Петербург, ул. Калинина, д. 2, корп. 4, лит. А