

# Film Capacitors

## Metallized Polypropylene Film Capacitors (MKP)

**Series/Type:** B32671Z ... B32676Z

**Date:** June 2018

© EPCOS AG 2018. Reproduction, publication and dissemination of this publication, enclosures hereto and the information contained therein without EPCOS' prior express consent is prohibited.

EPCOS AG is a TDK Group Company.

**Power Factor Correction**
**Typical applications**

- PFC (Power Factor Correction)
- Not suitable for "across the line" applications

**Climatic**

- Max. operating temperature: 125 °C
- Climatic category (IEC 60068-1:2013): 55/110/56

**Construction**

- Dielectric: metallized polypropylene (PP)
- Wound capacitor technology
- Plastic case (UL 94 V-0)
- Epoxy resin sealing, flame retardant

**Features**

- High frequency capability
- Very small dimensions
- RoHS-compatible
- Halogen-free capacitors available on request
- AEC-Q200D compliant

**Terminals**

- Parallel wire leads, lead-free tinned

**Marking**

- Manufacturer's logo
- Rated capacitance (coded)
- Capacitance tolerance
- Rated DC voltage
- Type number

**Delivery mode**

- Bulk (untaped)
- Taped (Ammo pack or reel)

For notes on taping, refer to chapter "Taping and packing".

**Dimensional drawing**

Dimensions in mm

Lead spacing	Lead diameter	Type
$e \pm 0.4$	$d_1 \pm 0.05$	
10	0.6	B32671Z
15	0.8	B32672Z
22.5	0.8	B32673Z
27.5	0.8	B32674Z
37.5	1.0	B32676Z



**Overview of available types**

Lead spacing	10 mm	15 mm			22.5 mm		
Type	B32671Z	B32672Z			B32673Z		
Page	5	6			7		
$V_{RMS}$ (V AC)	310	220	277	310	220	277	310
$V_R$ (V DC)	630	450	520	630	450	520	630
$C_R$ ( $\mu$ F)							
0.010							
0.015							
0.022							
0.033							
0.047							
0.068							
0.10							
0.12							
0.15							
0.22							
0.33							
0.47							
0.56							
0.68							
1.0							
1.2							
1.5							
2.2							



B32671Z ... B32676Z

Power Factor Correction

### Overview of available types

Lead spacing	27.5 mm			37.5 mm		
Type	B32674Z			B32676Z		
Page	8			9		
$V_{RMS}$ (V AC)	220	277	310	220	277	310
$V_R$ (V DC)	450	520	630	450	520	630
$C_R$ ( $\mu$ F)						
1.0						
1.5						
1.8						
2.2						
2.7						
3.3						
3.9						
4.7						
5.6						
6.8						
8.2						
10						
12						
15						
18						
22						

**Ordering codes and packing units (lead spacing 10 mm)**

$V_{RMS}$ $f \leq 1$ kHz V AC	$V_R$ V DC	$C_R$ $\mu F$	Max. dimensions $w \times h \times l$ mm	Ordering code (composition see below)	Ammo pack pcs./MOQ	Reel pcs./MOQ	Untaped pcs./MOQ
310	630	0.010	4.0 × 9.0 × 13.0	B32671Z6103+***	4000	6800	4000
		0.015	4.0 × 9.0 × 13.0	B32671Z6153+***	4000	6800	4000
		0.022	4.0 × 9.0 × 13.0	B32671Z6223+***	4000	6800	4000
		0.033	5.0 × 11.0 × 13.0	B32671Z6333+***	3320	5200	4000
		0.047	5.0 × 11.0 × 13.0	B32671Z6473+***	3320	5200	4000
		0.068	6.0 × 12.0 × 13.0	B32671Z6683+***	2720	4400	4000
		0.10	6.0 × 12.0 × 13.0	B32671Z6104+***	2720	4400	4000

MOQ = Minimum Order Quantity, consisting of 4 packing units.

Further E series, intermediate capacitance values and closer tolerance on request.

**Composition of ordering code**

+ = Capacitance tolerance code:

K =  $\pm 10\%$

J =  $\pm 5\%$

\*\*\* = Packaging code:

000 = Straight terminals, untaped (standard lead length 6 – 1 mm)

003 = Straight terminals, untaped (lead length 3.2  $\pm$  0.3 mm)

289 = Straight terminals, Ammo pack

**B32672Z**
**Power Factor Correction**
**Ordering codes and packing units (lead spacing 15 mm)**

$V_{RMS}$ $f \leq 1$ kHz V AC	$V_R$ V DC	$C_R$ $\mu F$	Max. dimensions $w \times h \times l$ mm	Ordering code (composition see below)	Ammo pack pcs./MOQ	Reel pcs./MOQ	Untaped pcs./MOQ
220	450	0.10	5.0 × 10.5 × 18.0	B32672Z4104+***	4680	5200	4000
		0.15	5.0 × 10.5 × 18.0	B32672Z4154+***	4680	5200	4000
		0.22	6.0 × 11.0 × 18.0	B32672Z4224+***	3840	4400	4000
		0.33	7.0 × 12.5 × 18.0	B32672Z4334+***	3320	3600	4000
		0.47	8.0 × 14.0 × 18.0	B32672Z4474+***	2920	3000	2000
		0.68	9.0 × 17.5 × 18.0	B32672Z4684+***	2560	2800	2000
		1.0	11.0 × 18.5 × 18.0	B32672Z4105+***	–	2200	1200
277	520	0.047	5.0 × 10.5 × 18.0	B32672Z5473+***	4680	5200	4000
		0.10	6.0 × 11.0 × 18.0	B32672Z5104+***	3840	4400	4000
		0.15	6.0 × 11.0 × 18.0	B32672Z5154+***	3840	4400	4000
		0.22	7.0 × 12.5 × 18.0	B32672Z5224+***	3320	3600	4000
		0.33	8.5 × 14.5 × 18.0	B32672Z5334+***	2720	2800	2000
		0.47	9.0 × 17.5 × 18.0	B32672Z5474+***	2560	2800	2000
		0.68	11.0 × 18.5 × 18.0	B32672Z5684+***	–	2000	1200
		1.0	11.0 × 18.5 × 18.0	B32672Z5105K***	–	2200	1200
310	630	0.033	5.0 × 10.5 × 18.0	B32672Z6333+***	4680	5200	4000
		0.047	5.0 × 10.5 × 18.0	B32672Z6473+***	4680	5200	4000
		0.068	5.0 × 10.5 × 18.0	B32672Z6683+***	4680	5200	4000
		0.10	6.0 × 11.0 × 18.0	B32672Z6104+***	3840	4400	4000
		0.12	6.0 × 11.0 × 18.0	B32672Z6124+***	3840	4400	4000
		0.15	6.0 × 12.0 × 18.0	B32672Z6154+***	3840	4400	4000
		0.33	8.5 × 14.5 × 18.0	B32672Y6334K***	2720	2800	2000
		0.33	9.0 × 17.5 × 18.0	B32672Z6334+***	2560	2800	2000
		0.47	11.0 × 18.5 × 18.0	B32672Z6474+***	–	2000	1200
		0.56	11.0 × 18.5 × 18.0	B32672Z6564+***	–	2200	1200

MOQ = Minimum Order Quantity, consisting of 4 packing units.

Further E series, intermediate capacitance values and closer tolerance on request.

**Composition of ordering code**

+ = Capacitance tolerance code:

K = ±10%

J = ±5%

\*\*\* = Packaging code:

000 = Straight terminals, untaped (standard lead length 6 – 1 mm)

003 = Straight terminals, untaped (lead length 3.2 ± 0.3 mm)

289 = Straight terminals, Ammo pack

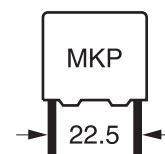
**Ordering codes and packing units (lead spacing 22.5 mm)**

$V_{RMS}$ $f \leq 1$ kHz V AC	$V_R$ V DC	$C_R$ $\mu F$	Max. dimensions $w \times h \times l$ mm	Ordering code (composition see below)	Ammo pack pcs./MOQ	Reel pcs./MOQ	Untaped pcs./MOQ
220	450	0.22	6.0 × 15.0 × 26.5	B32673Z4224+***	2720	2800	2880
		0.22	7.5 × 14.0 × 26.5	B32673T4224K***	2200	2000	2280
		0.33	6.0 × 15.0 × 26.5	B32673Z4334+***	2720	2800	2880
		0.33	7.5 × 14.0 × 26.5	B32673T4334K***	2200	2000	2280
		0.47	6.0 × 15.0 × 26.5	B32673Z4474+***	2720	2800	2880
		0.47	7.5 × 14.0 × 26.5	B32673T4474K***	2200	2000	2280
		0.68	7.0 × 16.0 × 26.5	B32673Z4684+***	2320	2400	2520
		0.68	7.5 × 14.0 × 26.5	B32673T4684+***	2200	2000	2280
		1.0	10.5 × 16.5 × 26.5	B32673Z4105+***	1560	1600	2160
		1.5	11.0 × 20.5 × 26.5	B32673Z4155+***	1480	1400	2040
		2.2	12.0 × 22.5 × 26.5	B32673Z4225+***	—	—	1800
277	520	0.22	6.0 × 15.0 × 26.5	B32673Z5224+***	2720	2800	2880
		0.22	7.5 × 14.0 × 26.5	B32673T5224K***	2200	2000	2280
		0.33	6.0 × 15.0 × 26.5	B32673Z5334+***	2720	2800	2880
		0.33	7.5 × 14.0 × 26.5	B32673T5334K***	2200	2000	2280
		0.47	7.0 × 16.0 × 26.5	B32673Z5474+***	2320	2400	2520
		0.47	7.5 × 14.0 × 26.5	B32673T5474K***	2200	2000	2280
		0.68	10.5 × 16.5 × 26.5	B32673Z5684+***	1560	1600	2160
		1.0	10.5 × 16.5 × 26.5	B32673Z5105+***	—	—	2160
		1.5	12.0 × 22.5 × 26.5	B32673Z5155+***	—	—	1800
310	630	0.15	6.0 × 15.0 × 26.5	B32673Z6154+***	2720	2800	2880
		0.22	6.0 × 15.0 × 26.5	B32673Z6224+***	2720	2800	2880
		0.33	7.0 × 16.0 × 26.5	B32673Z6334+***	2820	2400	2520
		0.33	7.5 × 14.0 × 26.5	B32673T6334+***	2200	2000	2280
		0.47	8.5 × 16.5 × 26.5	B32673Z6474+***	1920	2000	2040
		0.68	10.5 × 18.5 × 26.5	B32673Z6684+***	1560	1600	2160
		1.0	11.0 × 20.5 × 26.5	B32673Z6105+***	1480	1400	2040
		1.2	12.0 × 22.0 × 26.5	B32673Z6125+***	—	—	1800
		1.5	14.0 × 29.5 × 26.5	B32673Z6155+***	—	—	2160
		2.2	14.0 × 29.5 × 26.5	B32673Z6225+***	—	—	2160

MOQ = Minimum Order Quantity, consisting of 4 packing units.

Further E series, intermediate capacitance values and closer tolerance on request.

**Composition of ordering code**

+ = Capacitance tolerance code:

K = ±10%

J = ±5%

\*\*\* = Packaging code:

000 = Straight terminals, untaped (standard lead length 6 – 1 mm)

003 = Straight terminals, untaped (lead length 3.2 ±0.3 mm)

289 = Straight terminals, Ammo pack

**B32674Z**
**Power Factor Correction**
**Ordering codes and packing units (lead spacing 27.5 mm)**

$V_{RMS}$ $f \leq 1$ kHz V AC	$V_R$ V DC	$C_R$ $\mu F$	Max. dimensions $w \times h \times l$ mm	Ordering code (composition see below)	Ammo pack pcs./MOQ	Reel pcs./MOQ	Untaped pcs./MOQ		
220	450	1.5	11.0 × 19.0 × 31.5	B32674Z4155+***	—	1400	1280		
		1.8	11.0 × 21.0 × 31.5	B32674Z4185+***	—	2800	1280		
		2.2	11.0 × 21.0 × 31.5	B32674Z4225+***	—	2800	1280		
		2.7	13.5 × 23.0 × 31.5	B32674Z4275+***	—	1000	1040		
		3.3	14.0 × 24.5 × 31.5	B32674Z4335+***	—	1000	1040		
		3.9	16.0 × 32.0 × 31.5	B32674Z4395+***	—	—	880		
		4.7	16.0 × 32.0 × 31.5	B32674Z4475+***	—	—	880		
		5.6	18.0 × 33.0 × 31.5	B32674Z4565K***	—	—	880		
		6.8	21.0 × 31.0 × 31.5	B32674Z4685+***	—	—	720		
		8.2	22.0 × 36.5 × 31.5	B32674Z4825+***	—	—	640		
277	520	1.0	11.0 × 19.0 × 31.5	B32674Z5105+***	—	1400	1280		
		1.5	12.5 × 21.5 × 31.5	B32674Z5155+***	—	1200	1120		
		1.8	13.5 × 23.0 × 31.5	B32674Z5185+***	—	1000	1040		
		2.2	15.0 × 24.5 × 31.5	B32674Z5225+***	—	—	960		
		2.7	18.0 × 27.5 × 31.5	B32674Z5275+***	—	—	800		
		3.3	16.0 × 32.0 × 31.5	B32674Z5335K***	—	—	880		
		3.9	18.0 × 33.0 × 31.5	B32674Z5395+***	—	—	800		
		4.7	21.0 × 31.0 × 31.5	B32674Z5475+***	—	—	720		
				5.6	22.0 × 36.5 × 31.5	B32674Z5565+***	—	—	640
310	630	1.0	11.0 × 19.0 × 31.5	B32674Z6105+***	—	1400	1280		
		1.5	13.5 × 23.0 × 31.5	B32674Z6155+***	—	1000	1040		
		1.8	14.0 × 24.5 × 31.5	B32674Z6185+***	—	1000	1040		
		2.2	16.0 × 32.0 × 31.5	B32674Z6225+***	—	—	880		
		2.7	16.0 × 32.0 × 31.5	B32674Z6275K***	—	—	880		
		3.3	18.0 × 33.0 × 31.5	B32674Z6335+***	—	—	800		
		3.9	21.0 × 31.0 × 31.5	B32674Z6395+***	—	—	720		
				4.7	22.0 × 36.5 × 31.5	B32674Z6475+***	—	—	640

MOQ = Minimum Order Quantity, consisting of 4 packing units.

Further E series, intermediate capacitance values and closer tolerance on request.

**Composition of ordering code**

+ = Capacitance tolerance code:

K =  $\pm 10\%$

J =  $\pm 5\%$

\*\*\* = Packaging code:

000 = Straight terminals, untaped (standard lead length 6 – 1 mm)

003 = Straight terminals, untaped (lead length  $3.2 \pm 0.3$  mm)

289 = Straight terminals, Ammo pack

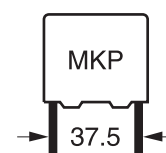

**Ordering codes and packing units (lead spacing 37.5 mm)**

$V_{RMS}$ $f \leq 1$ kHz V AC	$V_R$ V DC	$C_R$ $\mu F$	Max. dimensions $w \times h \times l$ mm	Ordering code (composition see below)	Ammo pack pcs./MOQ	Reel pcs./MOQ	Untaped pcs./MOQ
220	450	2.2	12.0 × 22.0 × 42.0	B32676Z4225+***	—	—	1620
		2.7	12.0 × 22.0 × 42.0	B32676Z4275+***	—	—	1620
		3.3	14.0 × 25.0 × 42.0	B32676Z4335+***	—	—	1380
		3.9	14.0 × 25.0 × 42.0	B32676Z4395+***	—	—	1380
		4.7	16.0 × 28.5 × 42.0	B32676Z4475+***	—	—	800
		5.6	16.0 × 28.5 × 42.0	B32676Z4565+***	—	—	800
		6.8	18.0 × 32.5 × 42.0	B32676Z4685+***	—	—	720
		8.2	20.0 × 39.5 × 42.0	B32676Z4825+***	—	—	640
		10.0	20.0 × 39.5 × 42.0	B32676Z4106+***	—	—	640
		12.0	20.0 × 39.5 × 42.0	B32676Z4126+***	—	—	640
		15.0	28.0 × 42.5 × 42.0	B32676Z4156+***	—	—	440
		18.0	30.0 × 45.0 × 42.0	B32676Z4186+***	—	—	400
		22.0	33.0 × 48.0 × 42.0	B32676Z4226+***	—	—	180
277	520	2.2	12.0 × 22.0 × 42.0	B32676Z5225+***	—	—	1620
		2.7	14.0 × 25.0 × 42.0	B32676Z5275+***	—	—	1380
		3.3	14.0 × 25.0 × 42.0	B32676Z5335+***	—	—	1380
		3.9	16.0 × 28.5 × 42.0	B32676Z5395+***	—	—	800
		4.7	18.0 × 32.5 × 42.0	B32676Z5475+***	—	—	720
		5.6	18.0 × 32.5 × 42.0	B32676Z5565+***	—	—	720
		6.8	20.0 × 39.5 × 42.0	B32676Z5685+***	—	—	640
		8.2	20.0 × 39.5 × 42.0	B32676Z5825K***	—	—	640
		10.0	28.0 × 37.0 × 42.0	B32676Z5106+***	—	—	440
		12.0	28.0 × 42.5 × 42.0	B32676Z5126K***	—	—	440
		15.0	33.0 × 48.0 × 42.0	B32676Z5156+***	—	—	180

MOQ = Minimum Order Quantity, consisting of 4 packing units.

Further E series, intermediate capacitance values and closer tolerance on request.

**Composition of ordering code**

+ = Capacitance tolerance code:

K =  $\pm 10\%$

J =  $\pm 5\%$

\*\*\* = Packaging code:

000 = Straight terminals, untaped (standard lead length 6 – 1 mm)

003 = Straight terminals, untaped (lead length  $3.2 \pm 0.3$  mm)

289 = Straight terminals, Ammo pack

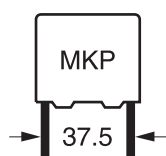
**B32676Z**
**Power Factor Correction**
**Ordering codes and packing units (lead spacing 37.5 mm)**

$V_{RMS}$ $f \leq 1$ kHz V AC	$V_R$ V DC	$C_R$ $\mu F$	Max. dimensions $w \times h \times l$ mm	Ordering code (composition see below)	Ammo pack pcs./MOQ	Reel pcs./MOQ	Untaped pcs./MOQ
310	630	1.8	14.0 × 25.0 × 42.0	B32676Z6185+***	—	—	1380
		2.2	14.0 × 25.0 × 42.0	B32676Z6225+***	—	—	1380
		2.7	14.0 × 25.0 × 42.0	B32676Z6275+***	—	—	1380
		3.3	16.0 × 28.5 × 42.0	B32676Z6335+***	—	—	800
		3.9	18.0 × 32.5 × 42.0	B32676Z6395+***	—	—	720
		4.7	18.0 × 32.5 × 42.0	B32676Z6475+***	—	—	720
		5.6	20.0 × 39.5 × 42.0	B32676Z6565+***	—	—	640
		6.8	20.0 × 39.5 × 42.0	B32676Z6685+***	—	—	640
		8.2	28.0 × 37.0 × 42.0	B32676Z6825+***	—	—	440
		10.0	28.0 × 42.5 × 42.0	B32676Z6106+***	—	—	440
		12.0	30.0 × 45.0 × 42.0	B32676Z6126+***	—	—	400
15.0	33.0 × 48.0 × 42.0	B32676Z6156+***	—	—	180		

MOQ = Minimum Order Quantity, consisting of 4 packing units.

Further E series, intermediate capacitance values and closer tolerance on request.

**Composition of ordering code**

+ = Capacitance tolerance code:

K =  $\pm 10\%$

J =  $\pm 5\%$

\*\*\* = Packaging code:

000 = Straight terminals, untaped (standard lead length 6 – 1 mm)

003 = Straight terminals, untaped (lead length  $3.2 \pm 0.3$  mm)

289 = Straight terminals, Ammo pack



### Technical data

Reference standard: IEC 60384-16:2005 and AEC-Q200D. All data given at T = 20 °C, unless otherwise specified.

Operating temperature range	Max. operating temperature $T_{op, max}$	+125 °C	
	Upper category temperature $T_{max}$	+110 °C	
	Lower category temperature $T_{min}$	-55 °C	
	Rated temperature $T_R$	+85 °C	
Dissipation factor $\tan \delta$ (in $10^{-3}$ ) at 20 °C (upper limit values)		$C_R \leq 0.1 \mu F$	$C_R > 0.1 \mu F$
	at 1 kHz	$\leq 1$ (typically 0.6)	1.0
	100 kHz	5.0	–
Insulation resistance $R_{ins}$ or time constant $\tau = C_R \cdot R_{ins}$ at 20 °C, rel. humidity $\leq 65\%$ (minimum as-delivered values)	$> 30\,000 \text{ M}\Omega$	$(C_R \leq 0.33 \mu F)$	
	$> 10\,000 \text{ s}$	$(C_R > 0.33 \mu F)$	
DC test voltage	$1.6 \times V_R, 2 \text{ s}$		
Category voltage $V_C$ continuous operation with $V_{DC}$ or $V_{AC}$ at $f \leq 1 \text{ kHz}$	$T_{op} (\text{°C})$	DC voltage derating	AC voltage derating
	$T_{op} \leq 85$	$V_C = V_R$	$V_{RMS} = V_{RMS}$
	$85 < T_{op} \leq 110$	$V_C = V_R \cdot (165 - T_{op})/80$	$V_{RMS} = V_{RMS} \cdot (165 - T_{op})/80$
short time operation with $V_{DC}$ or $V_{AC}$ at $f \leq 1 \text{ kHz}$	$110 < T_{op} \leq 125$	$V_C = V_R \cdot (165 - T_{op})/80$	$V_{RMS} = V_{RMS} \cdot (165 - T_{op})/80$
Operating voltage $V_{op}$ for short operating periods ( $V_{DC}$ or $V_{AC}$ at $f \leq 1 \text{ kHz}$ )	$T_{op} (\text{°C})$	DC voltage (max. hours)	AC voltage (max. hours)
	$T_{op} \leq 100$	$V_{op} = 1.25 \cdot V_C$ (2000 h)	$V_{op} = 1.0 \cdot V_{C,RMS}$ (2000 h)
	$100 < T_{op} \leq 125$	$V_{op} = 1.25 \cdot V_C$ (1000 h)	$V_{op} = 1.0 \cdot V_{C,RMS}$ (1000 h)
Passive flammability category in accordance to IEC 40(CO)752	C		
Biased humidity Limit values after test	1000 hours / 40°C / 93% relative humidity with $V_{R,DC}$		
	Capacitance change $ \Delta C/C $	$\leq 5\%$	
	Dissipation factor change $\Delta \tan \delta$	$\leq 2.0 \cdot 10^{-3}$ (at 1 kHz)	
	Insulation resistance $R_{ins}$	$\geq 200 \text{ M}\Omega$	
Reliability: Failure rate $\lambda$ Service life $t_{SL}$	1 fit ( $\leq 1 \cdot 10^{-9}/h$ ) at $0.5 \cdot V_R, 40 \text{ °C}$ 20000 h at $1.0 \cdot V_R, 85 \text{ °C}$ For conversion to other operating conditions and temperatures, refer to chapter "Quality, 2 Reliability".		
Failure criteria: Total failure Failure due to variation of parameters	Short circuit or open circuit		
	Capacitance change $ \Delta C/C $	$> 10\%$	
	Dissipation factor $\tan \delta$	$> 4 \cdot$ upper limit values	
	Insulation resistance $R_{ins}$	$< 1500 \text{ M}\Omega$ ( $C_R \leq 0.33 \mu F$ )	
	or time constant $\tau$	$< 50 \text{ s}$ ( $C_R \geq 0.33 \mu F$ )	



B32671Z ... B32676Z

**Power Factor Correction**

**Pulse handling capability**

"dV/dt" represents the maximum permissible voltage change per unit of time for non-sinusoidal voltages, expressed in V/μs.

"k<sub>0</sub>" represents the maximum permissible pulse characteristic of the waveform applied to the capacitor, expressed in V<sup>2</sup>/μs.

*Note:*

*The values of dV/dt and k<sub>0</sub> provided below must not be exceeded in order to avoid damaging the capacitor. These parameters are given for isolated pulses in such a way that the heat generated by one pulse will be completely dissipated before applying the next pulse. For a train of pulses, please refer to the curves of permissible AC voltage-current versus frequency.*

**dV/dt values**

Lead spacing		10 mm	15 mm	22.5 mm	27.5 mm	37.5 mm
V <sub>R</sub> V DC	V <sub>RMS</sub> V AC	dV/dt in V/μs				
450	220	–	160	100	75	54
520	277	–	200	120	85	60
630	310	400	250	160	100	73

**k<sub>0</sub> values**

Lead spacing		10 mm	15 mm	22.5 mm	27.5 mm	37.5 mm
V <sub>R</sub> V DC	V <sub>RMS</sub> V AC	k <sub>0</sub> in V <sup>2</sup> /μs				
450	220	–	128 000	80 000	67 000	48 000
520	277	–	208 000	125 000	88 000	62 000
630	310	504 000	504 000	202 000	126 000	92 000

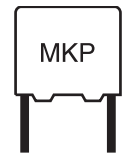

**Impedance Z versus frequency f**  
 (typical values)

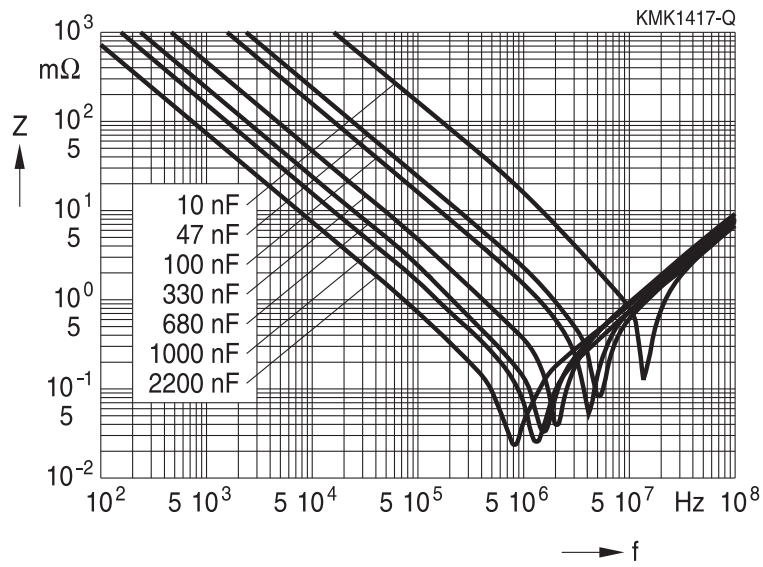

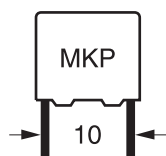

**B32671Z**

**Power Factor Correction**

**Permissible AC voltage  $V_{RMS}$  versus frequency  $f$  (for sinusoidal waveforms  $T_A \leq 90^\circ\text{C}$ )**

For  $T_A > 90^\circ\text{C}$ , please use the derating factor  $F_T$ .

**Lead spacing 10 mm**

**630 V DC/310 V AC**

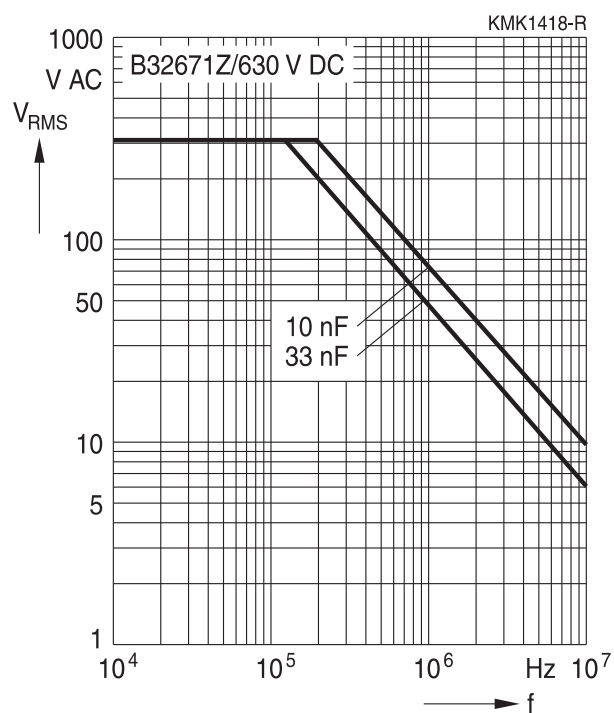

B32672Z

Power Factor Correction

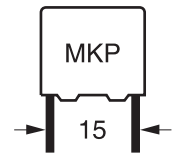

**Permissible AC voltage  $V_{RMS}$  versus frequency  $f$  (for sinusoidal waveforms  $T_A \leq 90^\circ C$ )**

For  $T_A > 90^\circ C$ , please use the derating factor  $F_T$ .

**Lead spacing 15 mm**

450 V DC/220 V AC

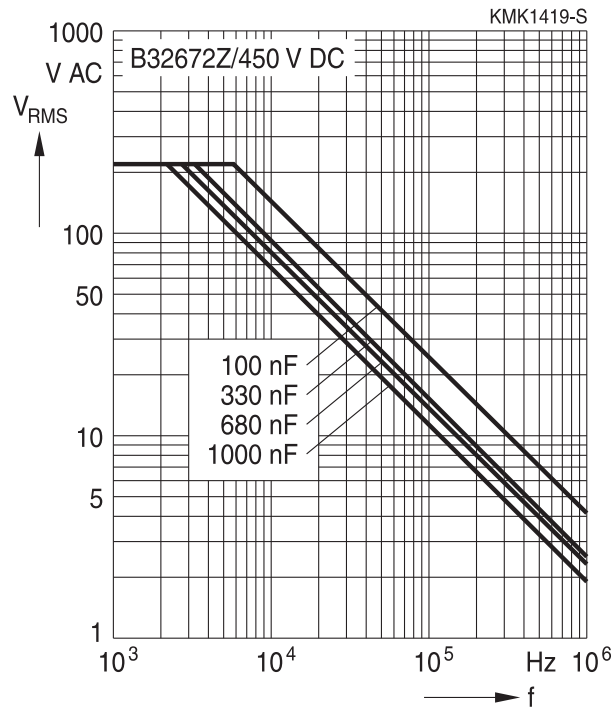

520 V DC/277 V AC

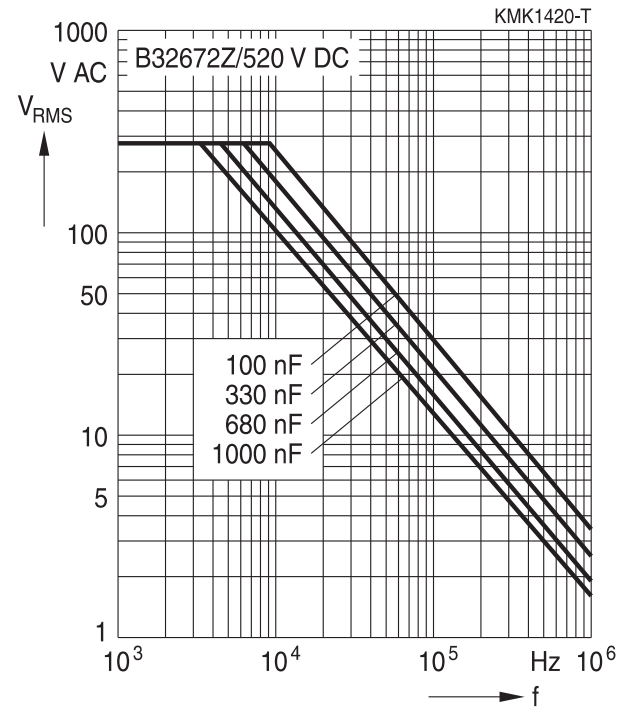

630 V DC/310 V AC

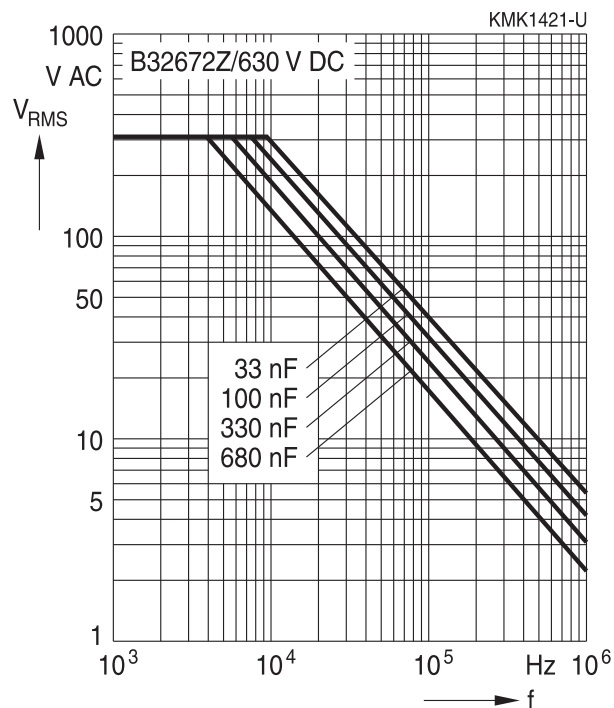

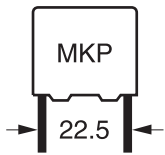

**B32673Z**

**Power Factor Correction**

**Permissible AC voltage  $V_{RMS}$  versus frequency  $f$  (for sinusoidal waveforms  $T_A \leq 90^\circ C$ )**

For  $T_A > 90^\circ C$ , please use the derating factor  $F_T$ .

**Lead spacing 22.5 mm**

450 V DC/220 V AC

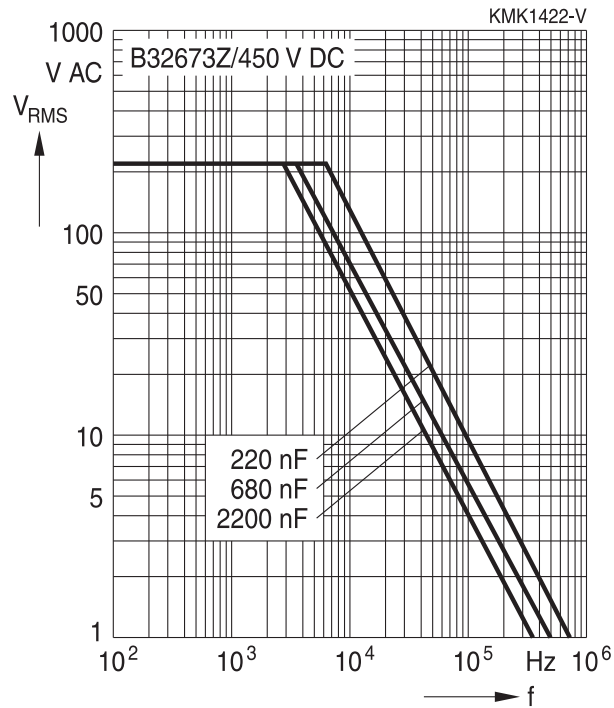

520 V DC/277 V AC

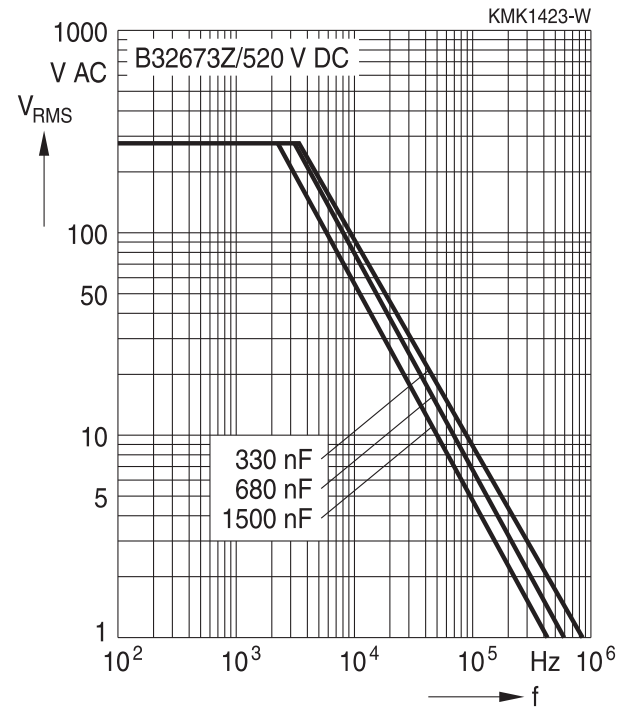

630 V DC/310 V AC

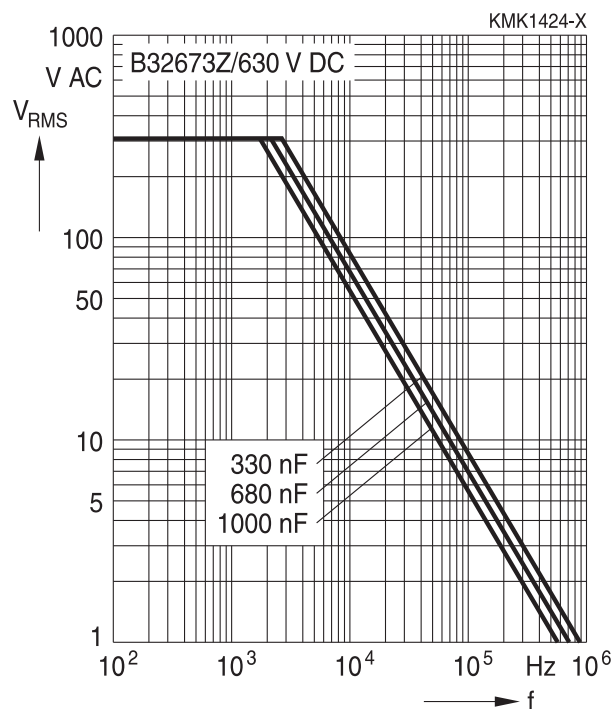



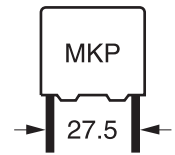

**Permissible AC voltage  $V_{RMS}$  versus frequency  $f$  (for sinusoidal waveforms  $T_A \leq 90^\circ C$ )**

For  $T_A > 90^\circ C$ , please use the derating factor  $F_T$ .

**Lead spacing 27.5 mm**

450 V DC/220 V AC

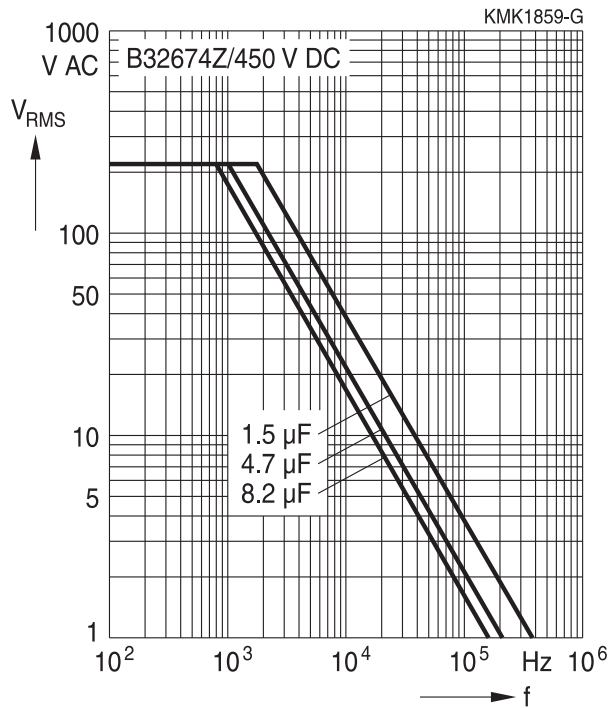

520 V DC/277 V AC

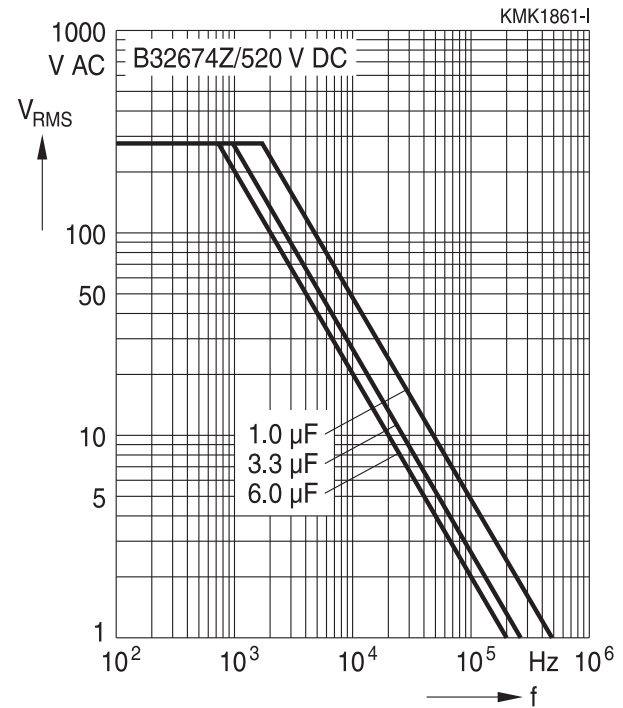

630 V DC/310 V AC

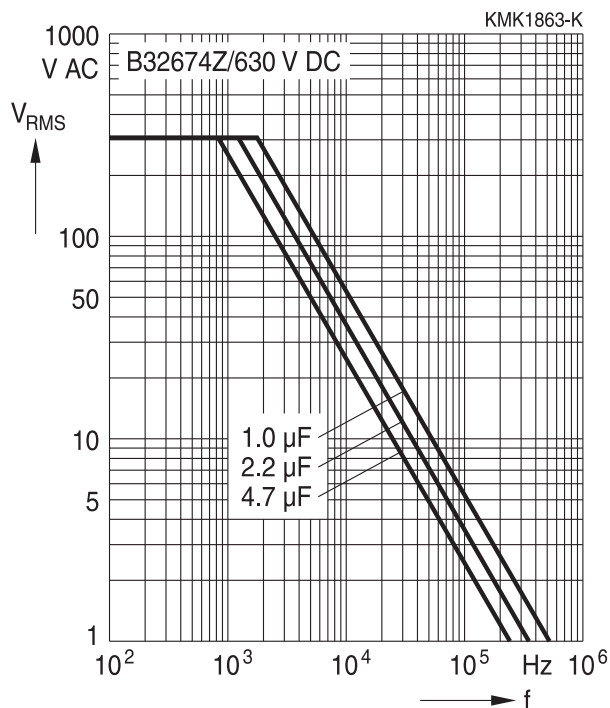

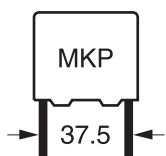

**B32676Z**

**Power Factor Correction**

**Permissible AC voltage  $V_{RMS}$  versus frequency  $f$  (for sinusoidal waveforms  $T_A \leq 90^\circ C$ )**

For  $T_A > 90^\circ C$ , please use the derating factor  $F_T$ .

**Lead spacing 37.5 mm**

450 V DC/220 V AC

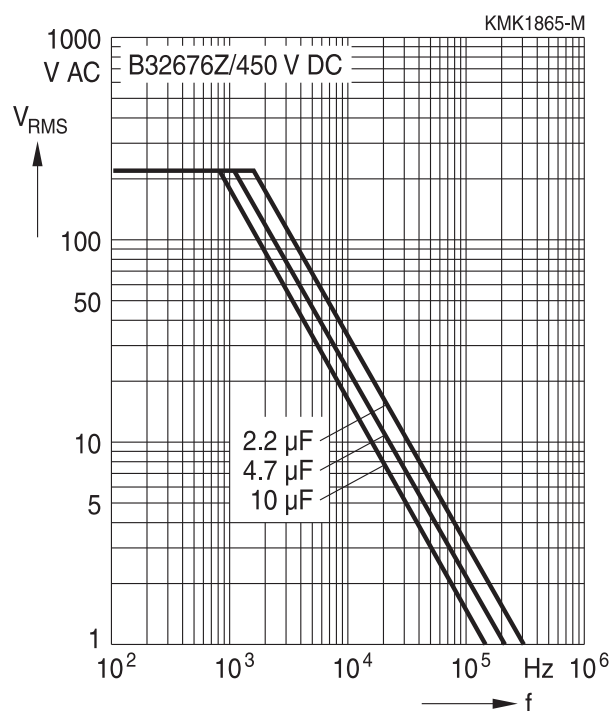

520 V DC/277 V AC

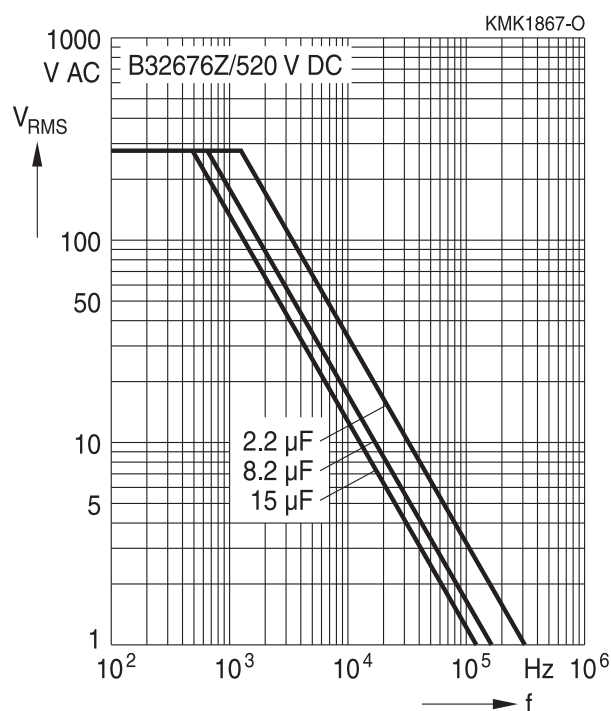

630 V DC/310 V AC

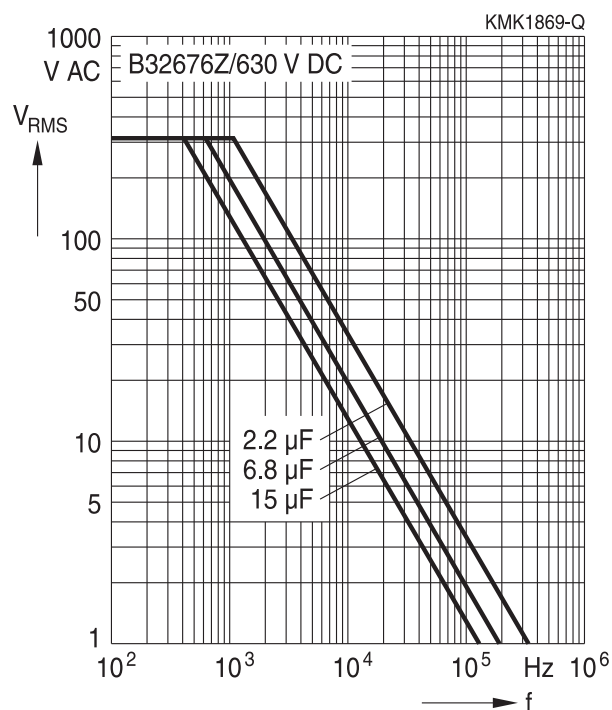

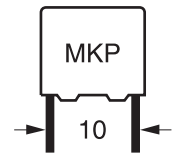

**Permissible current  $I_{RMS}$  versus frequency  $f$  (for sinusoidal waveforms  $T_{op} \leq 90\text{ }^\circ\text{C}$ )**

For  $T_A > 90\text{ }^\circ\text{C}$ , please use the derating factor  $F_T$ .

**Lead spacing 10 mm**

450 V DC/160 V AC

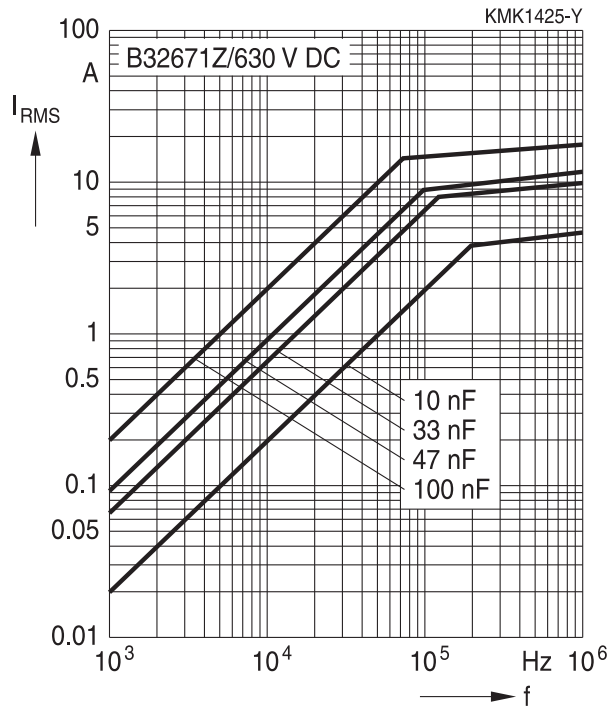

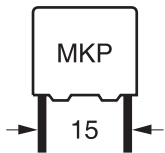

**B32672Z**

**Power Factor Correction**

**Permissible current  $I_{RMS}$  versus frequency  $f$  (for sinusoidal waveforms  $T_{op} \leq 90\text{ }^\circ\text{C}$ )**

For  $T_A > 90\text{ }^\circ\text{C}$ , please use the derating factor  $F_T$ .

**Lead spacing 15 mm**

450 V DC/160 V AC

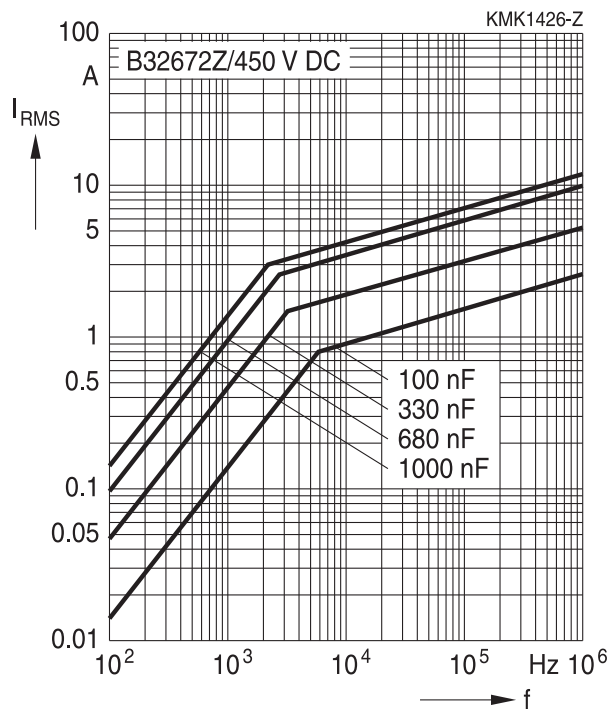

520 V DC/200 V AC

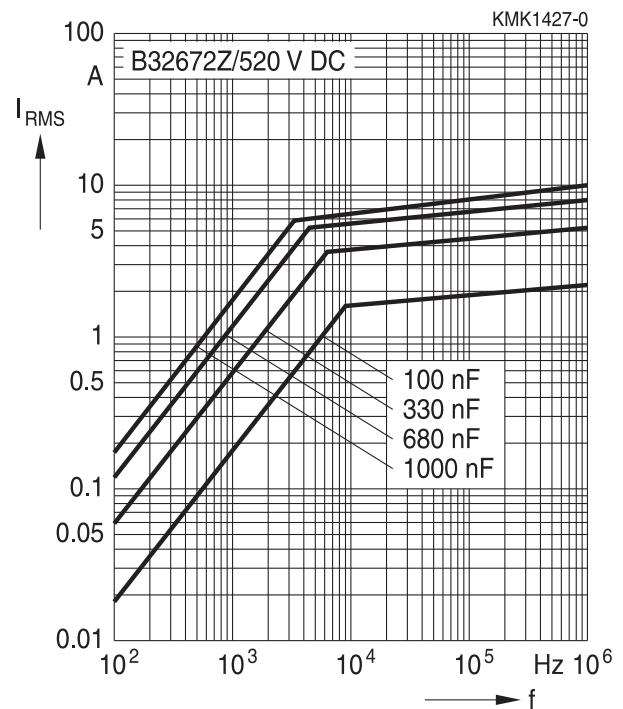

630 V DC/200 V AC

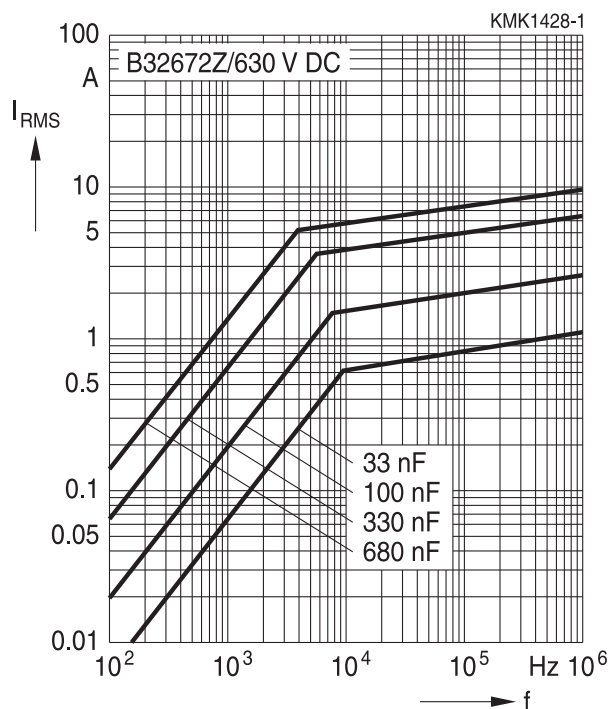

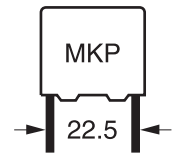

**Permissible current  $I_{RMS}$  versus frequency  $f$  (for sinusoidal waveforms  $T_{op} \leq 90^\circ C$ )**

For  $T_A > 90^\circ C$ , please use the derating factor  $F_T$ .

**Lead spacing 22.5 mm**

450 V DC/160 V AC

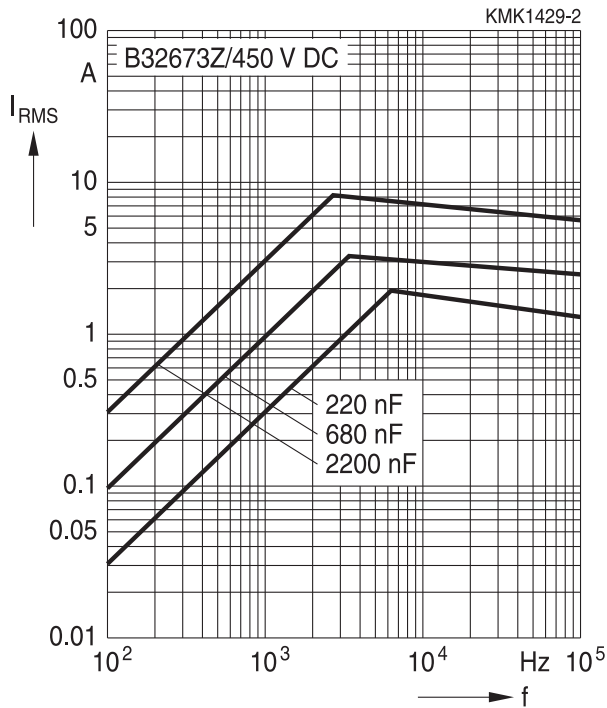

520 V DC/200 V AC

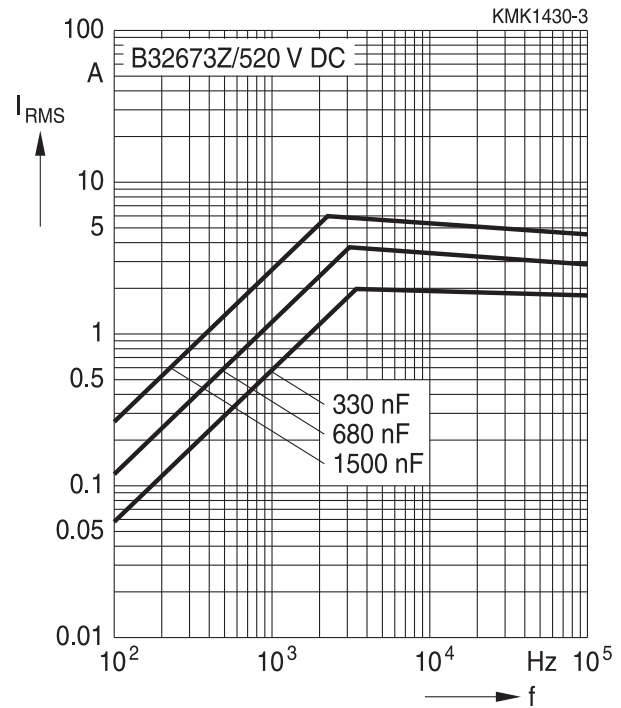

630 V DC/200 V AC

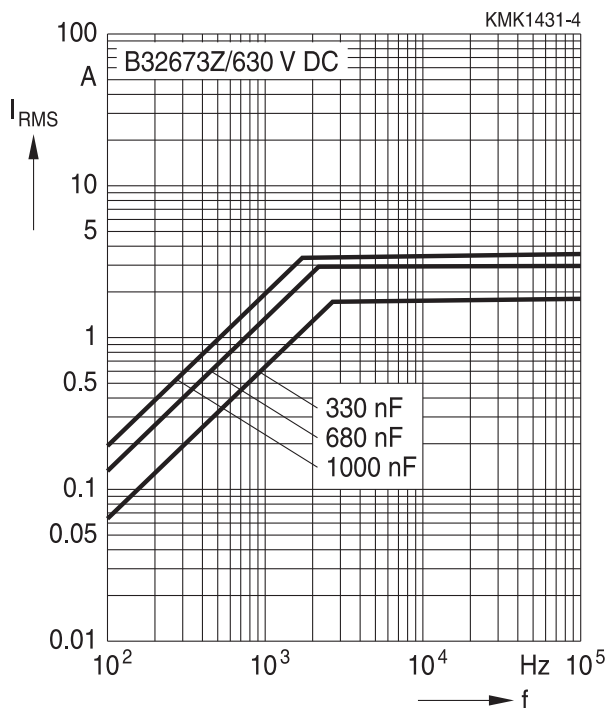

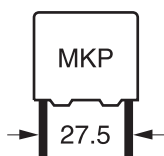

**B32674Z**

**Power Factor Correction**

**Permissible current  $I_{RMS}$  versus frequency  $f$  (for sinusoidal waveforms  $T_{op} \leq 90\text{ }^\circ\text{C}$ )**

For  $T_A > 90\text{ }^\circ\text{C}$ , please use the derating factor  $F_T$ .

**Lead spacing 27.5 mm**

450 V DC/160 V AC

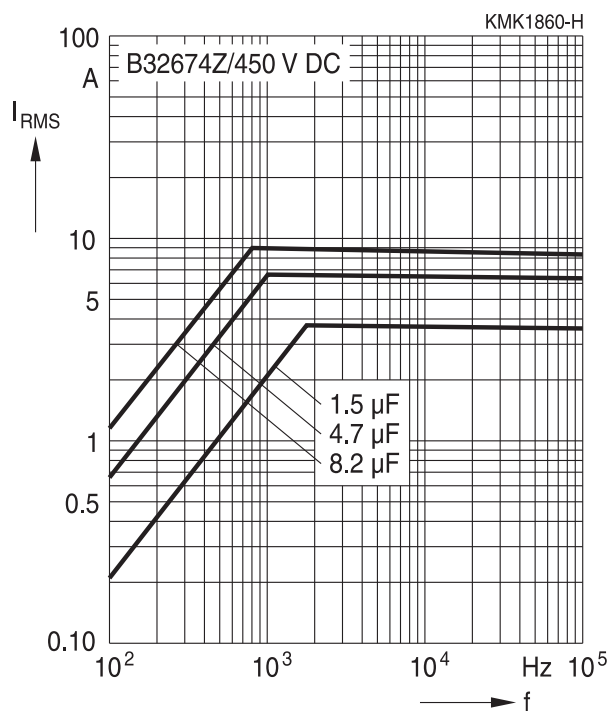

520 V DC/200 V AC

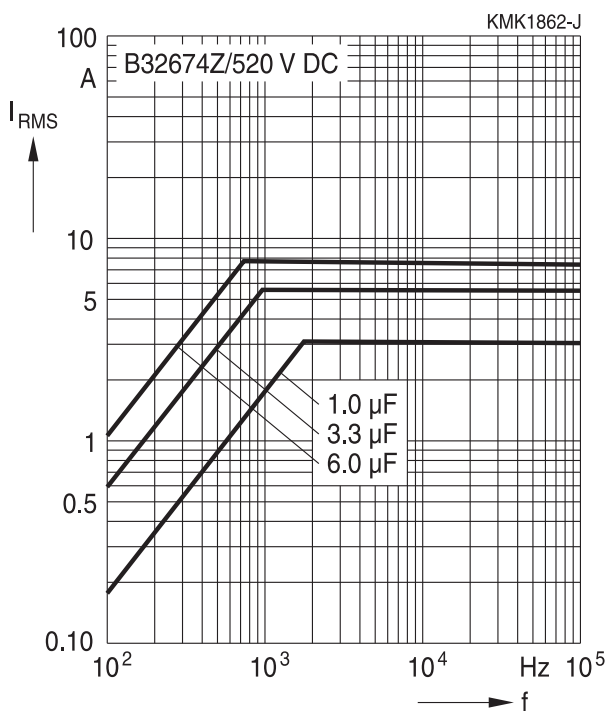

630 V DC/200 V AC

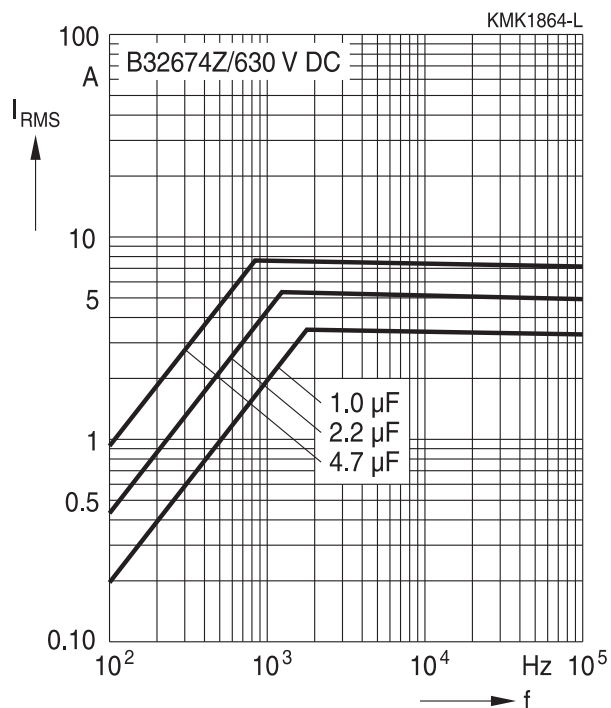

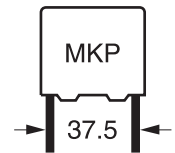

**Permissible current  $I_{RMS}$  versus frequency  $f$  (for sinusoidal waveforms  $T_{op} \leq 90^\circ C$ )**

For  $T_A > 90^\circ C$ , please use the derating factor  $F_T$ .

**Lead spacing 37.5 mm**

450 V DC/160 V AC

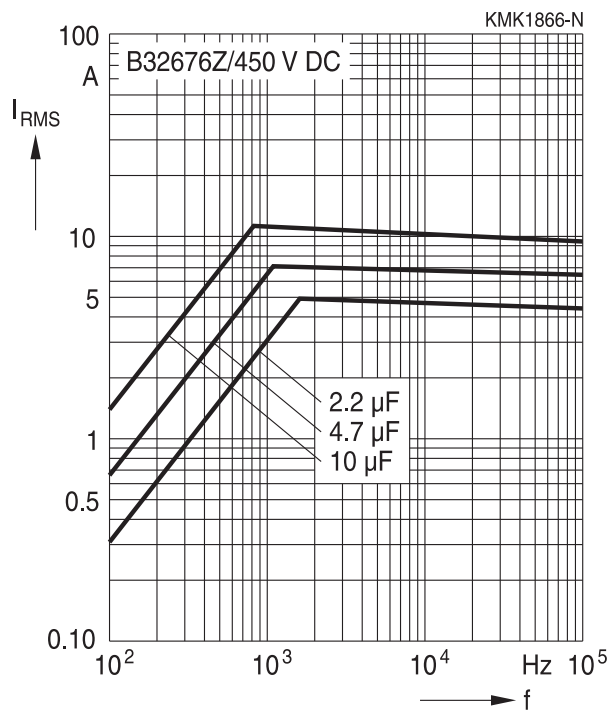

520 V DC/200 V AC

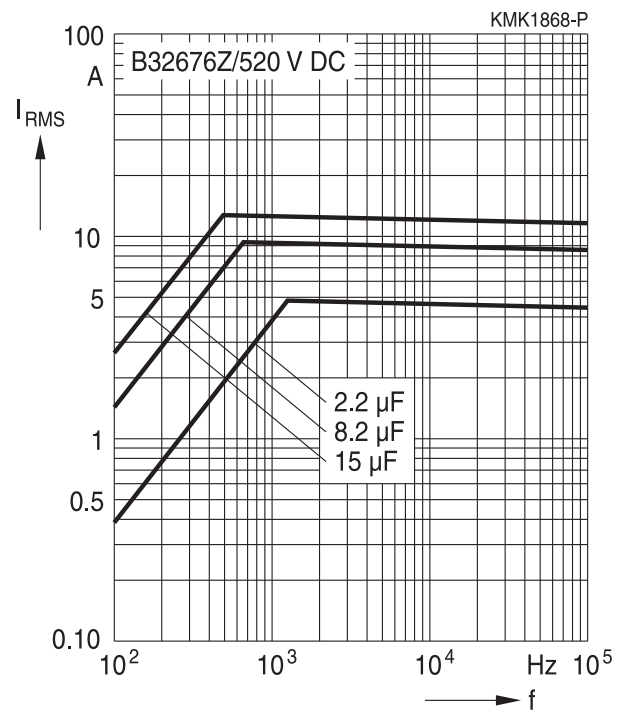

630 V DC/200 V AC

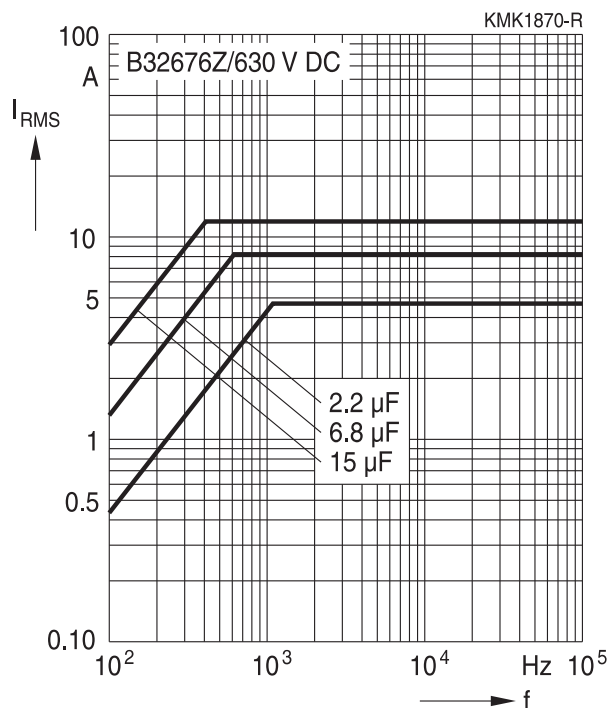



B32671Z ... B32676Z

Power Factor Correction

### Maximum AC Voltage ( $V_{RMS}$ ), Current ( $I_{RMS}$ ) versus frequency and temperature for $T_A > 90\text{ }^\circ\text{C}$

The graphs described in the previous section for the permissible AC voltage ( $V_{RMS}$ ) or current ( $I_{RMS}$ ) versus frequency are given for a maximum ambient temperature  $T_A \leq 90\text{ }^\circ\text{C}$ . In case of higher ambient temperatures ( $T_A$ ), the self-heating ( $\Delta T$ ) of the component must be reduced to avoid that temperature of the component ( $T_{op} = T_A + \Delta T$ ) reaches values above maximum operating temperature.

The factor  $F_T$  shall be applied in the following way:

$$I_{RMS}(T_A) = I_{RMS, T_A \leq 90\text{ }^\circ\text{C}} \cdot F_T(T_A)$$

$$V_{RMS}(T_A) = V_{RMS, T_A \leq 90\text{ }^\circ\text{C}} \cdot F_T(T_A)$$

$F_T$  is given by the following curve

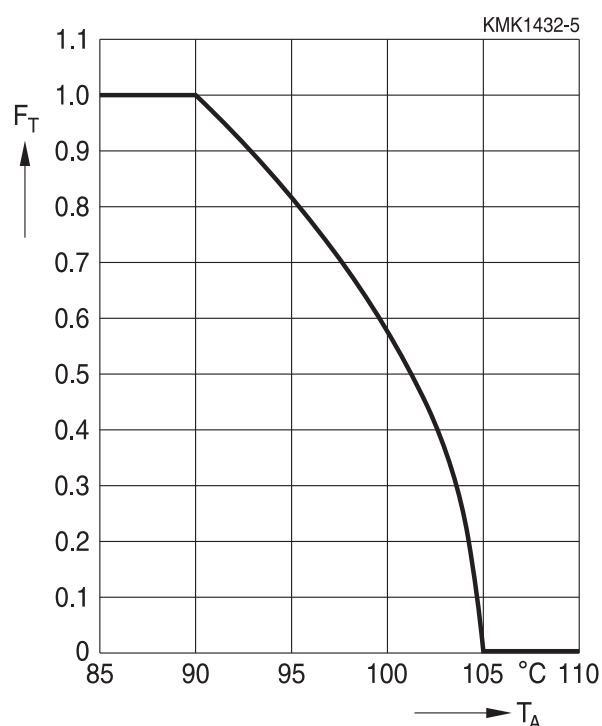

Maximum  $I_{RMS}$  current as function of the ambient temperature:  $I_{RMS}(T_A) = \text{Factor} \times I_{RMS}(70\text{ }^\circ\text{C})$





## Taping and packing

### 1 Capacitors with radial leads

Taping to IEC 60286-2:2015.

#### 1.1 Tape dimensions

##### Lead spacing 5 mm

Types: B32529, B32559 (MKT)

Standard 5 mm  
 $P_0 = 12.7$  mm

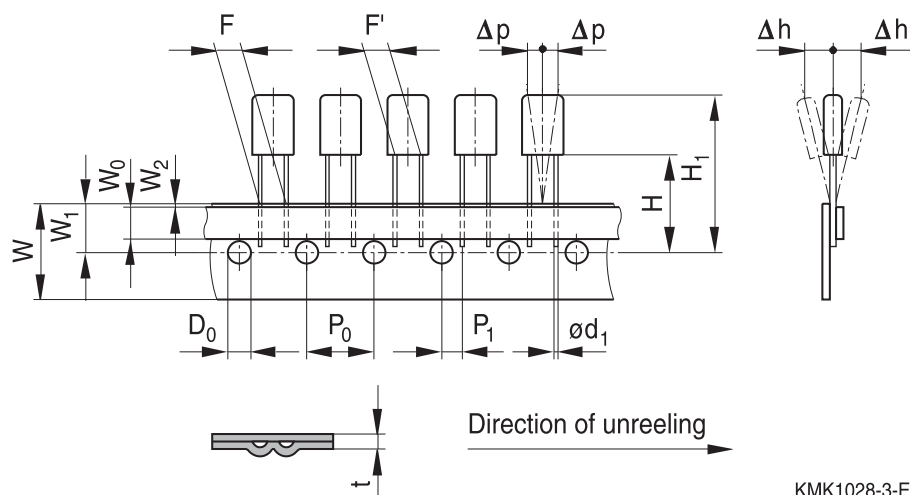

KMK1028-3-E

## Dimensions

Symbol	$\phi d_1$	$D_0$	$F$	$F'$	$H$	$H_1$	$P_0$	$P_1$
Dimension (mm)	0.5	4.0	5.0	5.0	18.5	32.2	12.7	3.8
Tolerance (mm)	$\pm 0.05$	$\pm 0.2$	$+0.6/-0.1$	$\pm 0.4$	$\pm 0.5$	max.	$\pm 0.2^*)$	$\pm 0.7$

Symbol	$W$	$W_0$	$W_1$	$W_2$	$t$	$\Delta h$	$\Delta p$
Dimension (mm)	18.0	6.0	9.0	0.5	0.7	0	0
Tolerance (mm)	$\pm 0.5$	$\pm 0.5$	$\pm 0.5$	$+2.5$	$\pm 0.2$	$\pm 2.0$	$\pm 1.3$

<sup>\*)</sup>  $\pm 1$  per  $20 \times P_0$



B32671Z ... B32676Z

Power Factor Correction

### Lead spacing 7.5 mm

Types: B32520, B32560 (MKT)  
B32620 (MKP)

Standard 7.5 mm  
 $P_0 = 12.7$  mm

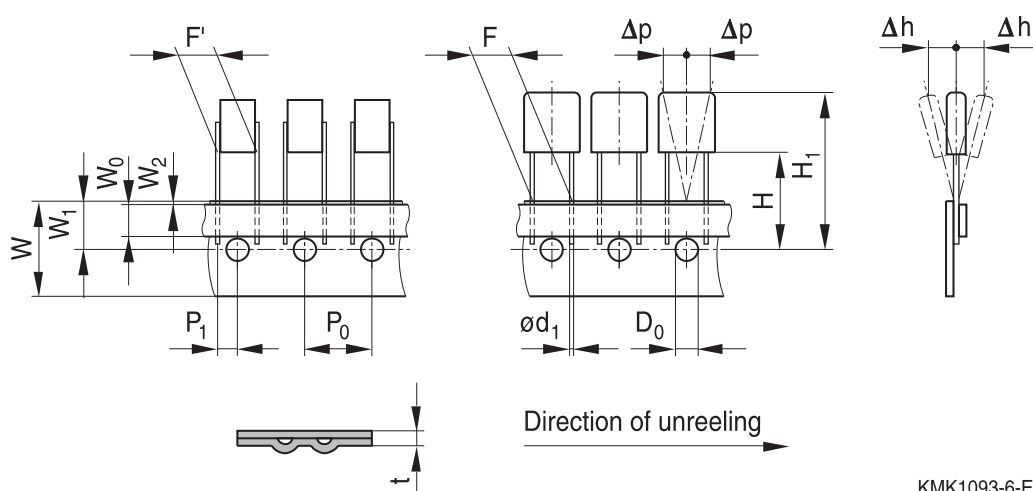

### Dimensions

Symbol	$\varnothing d_1$	$D_0$	F	F'	H	$H_1$	$P_0$	$P_1$
Dimension (mm)	0.5	4.0	7.5	7.5	18.5	32.2	12.7	3.8
Tolerance (mm)	$\pm 0.05$	$\pm 0.2$	$+0.6/-0.1$	$\pm 0.4$	$\pm 0.5$	max.	$\pm 0.2^*)$	$\pm 0.7$

Symbol	W	$W_0$	$W_1$	$W_2$	t	$\Delta h$	$\Delta p$
Dimension (mm)	18.0	6.0	9.0	0.5	0.7	0	0
Tolerance (mm)	$\pm 0.5$	$\pm 0.5$	$\pm 0.5$	+2.5	$\pm 0.2$	$\pm 2.0$	$\pm 1.3$

<sup>\*)</sup>  $\pm 1$  per  $20 \times P_0$

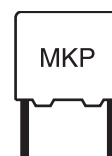

**B32671Z ... B32676Z**  
**Power Factor Correction**

**Lead spacing 10 mm**

Types:	B32521, B32561 (MKT)
	B32621, B32641, B32651, B32671 (MKP)
	B32021, B32911, B32921 (EMI suppression)

Standard 10 mm  
 $P_0 = 12.7$  mm

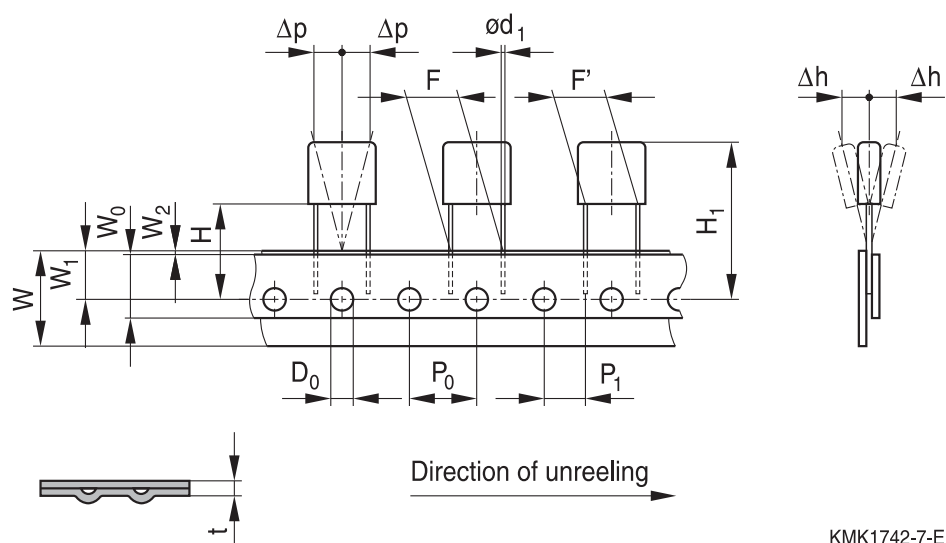

KMK1742-7-E

**Dimensions**

Symbol	$\phi d_1$	$D_0$	F	F'	H	$H_1$
Dimension (mm)	0.5; 0.6	4.0	10.0	10.0	18.5	32.2
Tolerance (mm)	$\pm 0.05$	$\pm 0.2$	$+0.6/-0.1$	$\pm 0.4$	$\pm 0.5$	max.

Symbol	$P_0$	$P_1$	W	$W_0$	$W_1$	$W_2$	t	$\Delta h$	$\Delta p$
Dimension (mm)	12.7	7.7	18.0	12.0	9.0	0.5	0.7	0	0
Tolerance (mm)	$\pm 0.2^*)$	$\pm 0.7$	$\pm 0.5$	$\pm 0.5$	$\pm 0.5$	$+2.5$	$\pm 0.2$	$\pm 2.0$	$\pm 1.3$

<sup>\*)</sup>  $\pm 1$  per  $20 \times P_0$



B32671Z ... B32676Z

Power Factor Correction

### Lead spacing 15 mm

Types:	B32522, B32562 (MKT) B32642, B32652, B32672 (MKP) B32682 (MFP) B32022, B32912, B32922, B32932, B81123 (EMI suppression)
--------	----------------------------------------------------------------------------------------------------------------------------------

Standard 15 mm

$P_0 = 12.7$  mm

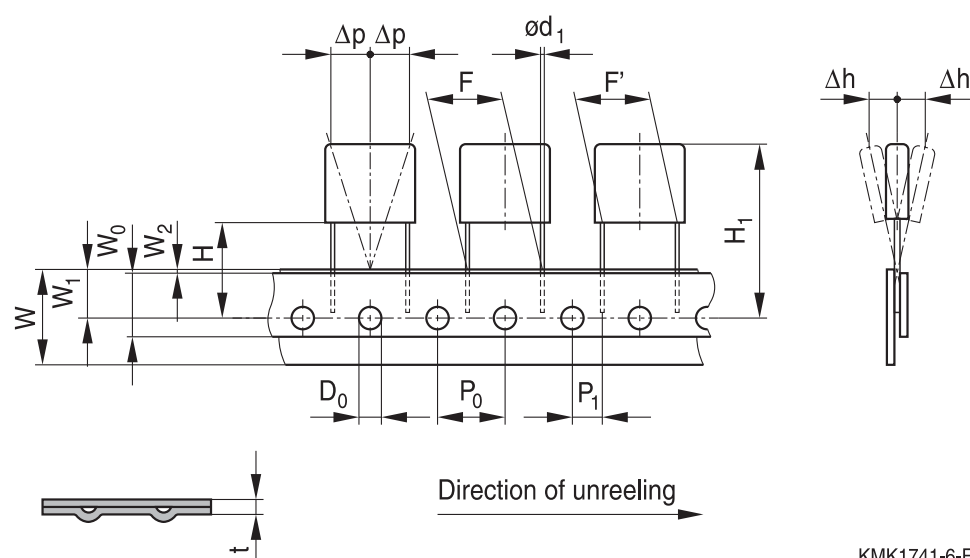

KMK1741-6-E

### Dimensions

Symbol	$\varnothing d_1$	$D_0$	F	F'	H	$H_1$
Dimension (mm)	0.6; 0.8	4.0	15.0	15.0	18.5	37.5
Tolerance (mm)	$\pm 0.05$	$\pm 0.2$	$+0.6/-0.1$	$\pm 0.4$	$\pm 0.5$	max.

Symbol	$P_0$	$P_1$	W	$W_0$	$W_1$	$W_2$	t	$\Delta h$	$\Delta p$
Dimension (mm)	12.7	5.2	18.0	12.0	9.0	0.5	0.7	0	0
Tolerance (mm)	$\pm 0.2^*)$	$\pm 0.7$	$\pm 0.5$	$\pm 0.5$	$\pm 0.5$	$+2.5$	$\pm 0.2$	$\pm 2.0$	$\pm 1.3$

$^*) \pm 1$  per  $20 \times P_0$

**Lead spacing 22.5 mm**

Types:	B32523, B32593 (MKT)
	B32613, B32643, B32653, B32673 (MKP)
	B32683 (MFP)
	B32023, B32033, B32913, B32923, B32933, B81123 (EMI suppression)

Standard 22.5 mm

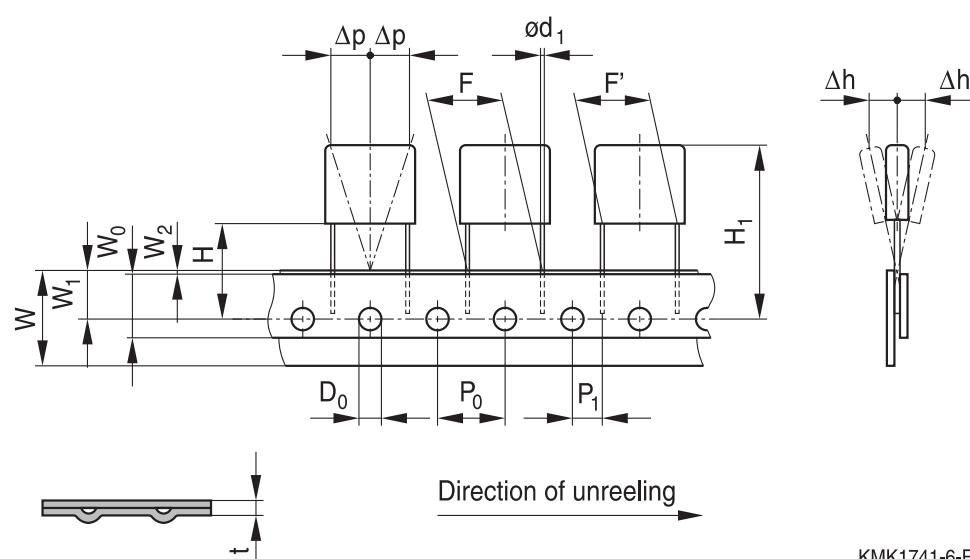
 $P_0 = 12.7$  mm

KMK1741-6-E

**Dimensions**

Symbol	$\varnothing d_1$	$D_0$	$F$	$F'$	$H$	$H_1$
Dimension (mm)	0.8	4.0	22.5	22.5	18.5	39.5
Tolerance (mm)	$\pm 0.05$	$\pm 0.2$	$+0.6/-0.1$	$\pm 0.4$	$\pm 0.5$	max.

Symbol	$P_0$	$P_1$	$W$	$W_0$	$W_1$	$W_2$	$t$	$\Delta h$	$\Delta p$
Dimension (mm)	12.7	7.8	18.0	12.0	9.0	0.5	0.7	0	0
Tolerance (mm)	$\pm 0.2^*)$	$\pm 0.7$	$\pm 0.5$	$\pm 0.5$	$\pm 0.5$	$+2.5$	$\pm 0.2$	$\pm 2.0$	$\pm 1.3$

 $^*) \pm 1$  per  $20 \times P_0$



**B32671Z ... B32676Z**

**Power Factor Correction**

**Lead spacing 27.5 mm**

Types:	B32524 (MKT)
	B32654, B32674, B32774 (MKP)
	B32684 (MFP)
	B32024, B32034, B32914, B32924, B32934 (EMI suppression)

Standard 27.5 mm  
 $P_0 = 12.7$  mm

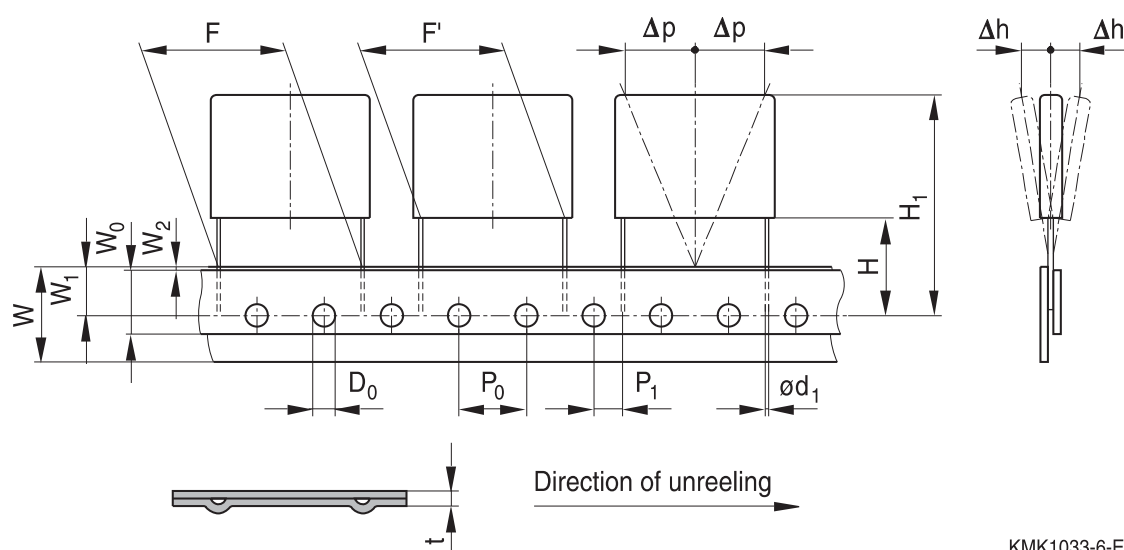

KMK1033-6-E

**Dimensions**

Symbol	$\phi d_1$	$D_0$	$F$	$F'$	$H$	$H_1$
Dimension (mm)	0.8	4.0	27.5	27.5	18.5	42.0
Tolerance (mm)	$\pm 0.05$	$\pm 0.2$	$+0.6/-0.1$	$\pm 0.4$	$\pm 0.5$	max.

Symbol	$P_0$	$P_1$	$W$	$W_0$	$W_1$	$W_2$	$t$	$\Delta h$	$\Delta p$
Dimension (mm)	12.7	5.3	18.0	12.0	9.0	0.5	0.7	0	0
Tolerance (mm)	$\pm 0.2^*)$	$\pm 0.7$	$\pm 0.5$	$\pm 0.5$	$\pm 0.5$	$+2.5$	$\pm 0.2$	$\pm 2.0$	$\pm 1.3$

<sup>\*)</sup>  $\pm 1$  per  $20 \times P_0$



## 1.2 Crimping

### Lead spacing 10 mm crimped down to 7.5 mm

$P_0 = 15.0$  mm, ending code 140 for Reel, ending code 240 for Ammo pack

Standard 10 mm

$P_0 = 15$  mm

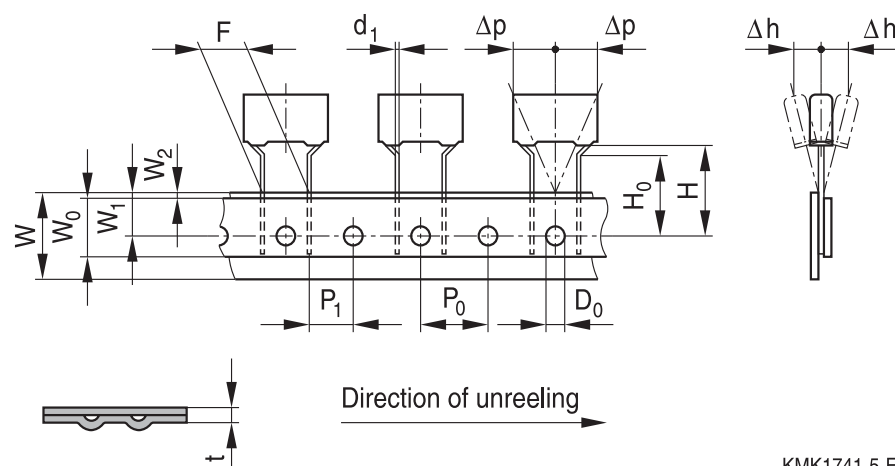

KMK1741-5-E

Symbol	$\varnothing d_1$	$D_0$	F	H	$H_0$	$P_0$	$P_1$
Dimension (mm)	0.5; 0.6	4.0	7.5	18.5	17.0	15.0	3.75
Tolerance (mm)	$\pm 0.05$	$\pm 0.2$	$+0.6/-0.1$	$\pm 0.5$	$\pm 0.5$	$\pm 0.2^{*)}$	$\pm 0.7$

Symbol	W	$W_0$	$W_1$	$W_2$	t	$\Delta h$	$\Delta p$
Dimension (mm)	18.0	12.0	9.0	0.5	0.7	0	0
Tolerance (mm)	$\pm 0.5$	$\pm 0.5$	$\pm 0.5$	$+2.5$	$\pm 0.2$	$\pm 2.0$	$\pm 1.3$

<sup>\*)</sup>  $\pm 1$  per  $20 \times P_0$

Packing unit and MOQ upon request.



B32671Z ... B32676Z

Power Factor Correction

**Lead spacing 15 mm crimped down to 7.5 mm**

$P_0 = 15.0$  mm, ending code 155 for Reel, ending code 255 for Ammo pack

Standard 15 mm

$P_0 = 15$  mm

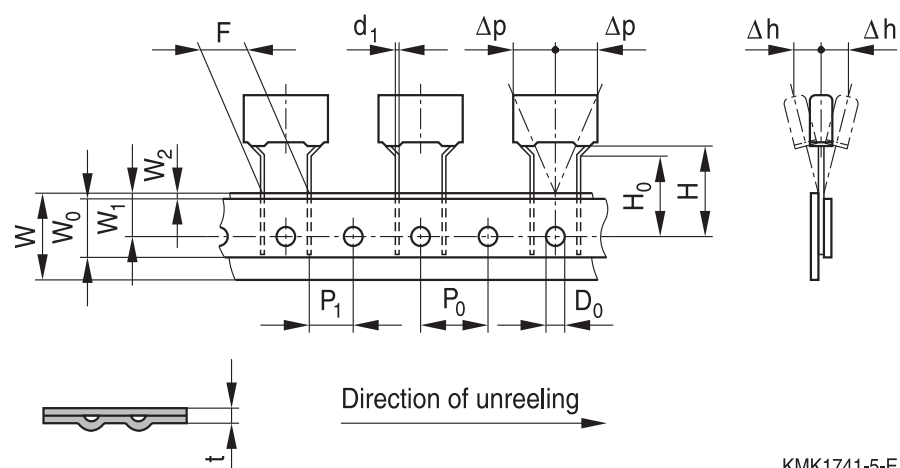

KMK1741-5-E

Symbol	$\varnothing d_1$	$D_0$	F	H	$H_0$	$P_0$	$P_1$
Dimension (mm)	0.6; 0.8	4.0	7.5	18.5	17.0	15.0	3.75
Tolerance (mm)	$\pm 0.05$	$\pm 0.2$	$+0.6/-0.1$	$\pm 0.5$	$\pm 0.5$	$\pm 0.2^{*)}$	$\pm 0.7$

Symbol	W	$W_0$	$W_1$	$W_2$	t	$\Delta h$	$\Delta p$
Dimension (mm)	18.0	12.0	9.0	0.5	0.7	0	0
Tolerance (mm)	$\pm 0.5$	$\pm 0.5$	$\pm 0.5$	$+2.5$	$\pm 0.2$	$\pm 2.0$	$\pm 1.3$

$^{*)} \pm 1$  per  $20 \times P_0$

Packing unit and MOQ upon request.



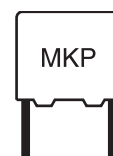

### 1.3 Packing

#### Reel packing

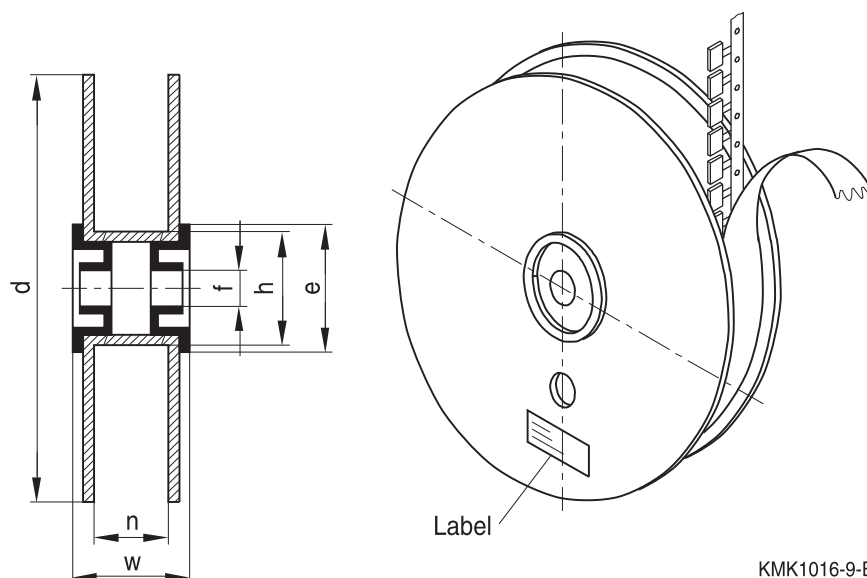

KMK1016-9-E

Dimensions (mm)	n	w	∅ d	∅ e	∅ f	∅ h
Lead spacing ≤7.5	42 +1	52 max.	360 -1	90	30.5 ±0.2	82 +1
Lead spacing 10, 15, 22.5, 27.5	54 +1	70 max.	500 -1	130	30.5 ±0.2	126 +1
<i>On request:</i>						
Lead spacing ≥10	54 +1	70 max.	360 -1	90	30.5 ±0.7	82 +1

#### Ammo packing

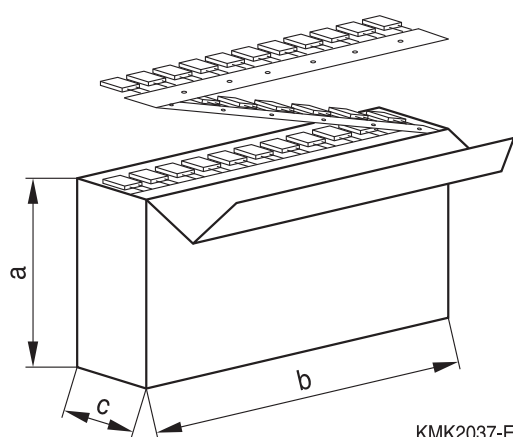

KMK2037-E

Dimensions (approximately)	Lead spacing (mm)							
	5	7.5	15	15	15	22.5	15	22.5
a (mm)	355		355		480		480	
b (mm)	350		350		355		355	
c (mm)	50		60		50		60	



B32671Z ... B32676Z

**Power Factor Correction**

## 2 General notes on packing

When packing our products, we pay attention to the needs of the environment by reducing the amount of packing to an absolute minimum and using environmentally compatible materials for packing. In doing so we are also complying with the German packaging legislation which came into force on the 1<sup>st</sup> December 1991.

In order to further comply with the aims of this legislation concerning the reduction of commercial waste, we have implemented the following measures:

- The use of "Euro" pallets.
- Goods are secured on the pallets using straps and edge protectors made of environmentally compatible plastics (PE or PP).
- The shipping cartons (transport packing) qualify for and carry the RESY logo.
- Separating layers are of paper.
- The shipping cartons are sealed with paper adhesive tape in order to ensure that only a single, uniform material needs to be disposed of.
- We are prepared, on principle, to take back the packing material (especially product-specific plastic packages, e.g. magazines). However, we ask our customers to send cardboard cartons, corrugated cardboard, paper etc. to recycling or disposal companies in order to avoid unnecessary transportation of empty packing materials.



## Testing and Standards

Test	Reference	Conditions of test	Performance requirements
Electrical parameters	IEC 60384-1:2016	Voltage proof, $1.6 V_R$ , 1 minute Insulation resistance, $R_{ins}$ Capacitance, C Dissipation factor, $\tan \delta$	Within specified limits
Robustness of terminations	IEC 60068-2-21:2006	Tensile strength (test Ua1) Wire diameter   Tensile force $0.5 < d1 < 0.8 \text{ mm}$   10 N	Capacitance and $\tan \delta$ within specified limits
Resistance to soldering heat	IEC 60068-2-20:2008, test Tb, method 1A	Solder bath temperature at $260 \pm 5 \text{ }^\circ\text{C}$ , immersion for 10 seconds	$\Delta C/C_0 \leq 2\%$ $ \Delta \tan \delta  \leq 0.002$
Rapid change of temperature	IEC 60384-16:2005	$T_A$ = lower category temperature $T_B$ = upper category temperature Five cycles, duration $t = 30 \text{ min.}$	
Vibration	IEC 60384-16:2005	Test $F_C$ : vibration sinusoidal Displacement: 0.75 mm Acceleration: $98 \text{ m/s}^2$ Frequency: 10 Hz ... 500 Hz Test duration: 3 orthogonal axes, 2 hours each axe	No visible damage
Bump	IEC 60384-16:2005	Test $E_b$ : Total 4000 bumps with $390 \text{ m/s}^2$ mounted on PCB Duration: 6 ms	No visible damage $ \Delta C/C_0  \leq 2\%$ $ \Delta \tan \delta  \leq 0.002$ $R_{ins} \geq 50\%$ of initial limit
Climatic sequence	IEC 60384-16:2005	Dry heat $T_b$ / 16 h Damp heat cyclic, 1 <sup>st</sup> cycle $+55 \text{ }^\circ\text{C} / 24 \text{ h} / 95\% \dots 100\% \text{ RH}$ Cold $T_a$ / 2 h Damp heat cyclic, 5 cycles $+55 \text{ }^\circ\text{C} / 24 \text{ h} / 95\% \dots 100\% \text{ RH}$	No visible damage $ \Delta C/C_0  \leq 3\%$ $ \Delta \tan \delta  \leq 0.001$ $R_{ins} \geq 50\%$ of initial limit
Damp heat, steady state	IEC 60384-16:2005	Test $C_a$ $40 \text{ }^\circ\text{C} / 93\% \text{ RH} / 56 \text{ days}$	No visible damage $ \Delta C/C_0  \leq 3\%$ $ \Delta \tan \delta  \leq 0.001$ $R_{ins} \geq 50\%$ of initial limit
High temperature high humidity with load		$60 \text{ }^\circ\text{C} / 95\% \text{ RH} / 1000 \text{ hours}$ with $V_{R,DC}$	No visible damage $ \Delta C/C_0  \leq 10\%$ $ \Delta \tan \delta  \leq 0.004$ $R_{ins} \geq 50\%$ of initial limit



B32671Z ... B32676Z

**Power Factor Correction**

Test	Reference	Conditions of test	Performance requirements
Endurance	IEC 60384-16:2005	85 °C / 1.25 V <sub>R</sub> / 2000 hours	No visible damage  ΔC/C <sub>0</sub>   ≤ 5%  Δ tan δ  ≤ 0.004 R <sub>ins</sub> ≥ 50% of initial limit
Endurance	IEC 60384-16:2005	110 °C / 1.25 V <sub>C</sub> / 2000 hours	No visible damage  ΔC/C <sub>0</sub>   ≤ 10%  Δ tan δ  ≤ 0.004 R <sub>ins</sub> ≥ 50% of initial limit

**Mounting guidelines**

**1 Soldering**

**1.1 Solderability of leads**

The solderability of terminal leads is tested to IEC 60068-2-20, test Ta, method 1.

Before a solderability test is carried out, terminals are subjected to accelerated ageing (to IEC 60068-2-2, test Ba: 4 h exposure to dry heat at 155 °C). Since the ageing temperature is far higher than the upper category temperature of the capacitors, the terminal wires should be cut off from the capacitor before the ageing procedure to prevent the solderability being impaired by the products of any capacitor decomposition that might occur.

Solder bath temperature	235 ±5 °C
Soldering time	2.0 ±0.5 s
Immersion depth	2.0 +0/-0.5 mm from capacitor body or seating plane
Evaluation criteria:	
Visual inspection	Wetting of wire surface by new solder ≥90%, free-flowing solder



## 1.2 Resistance to soldering heat

Resistance to soldering heat is tested to IEC 60068-2-20, test Tb, method 1.

Conditions:

Series	Solder bath temperature	Soldering time
MKT boxed (except 2.5 × 6.5 × 7.2 mm) coated uncoated (lead spacing >10 mm)	260 ±5 °C	10 ±1 s
MFP		
MKP (lead spacing >7.5 mm)		
MKT boxed (case 2.5 × 6.5 × 7.2 mm)	260 ±5 °C	5 ±1 s
MKP (lead spacing ≤7.5 mm)		<4 s
MKT uncoated (lead spacing ≤10 mm) insulated (B32559)		recommended soldering profile for MKT uncoated (lead spacing ≤ 10 mm) and insulated (B32559)

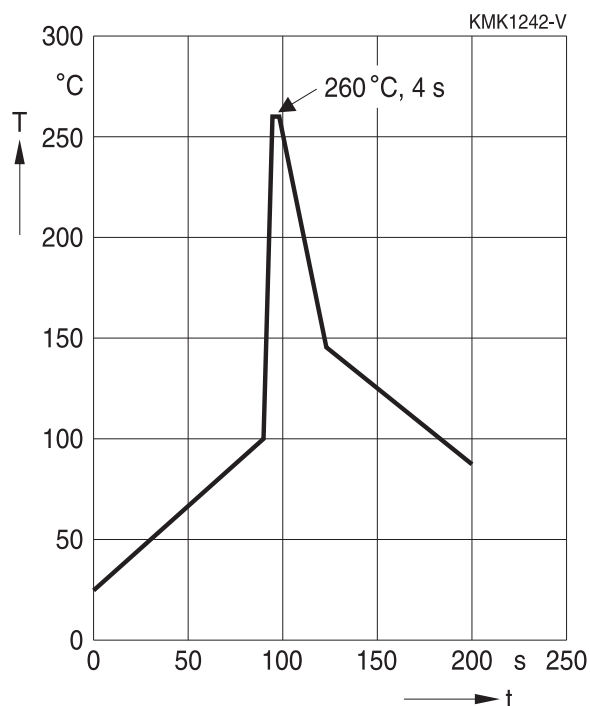

Immersion depth	2.0 +0/−0.5 mm from capacitor body or seating plane
Shield	Heat-absorbing board, (1.5 ±0.5) mm thick, between capacitor body and liquid solder
Evaluation criteria:	
Visual inspection	No visible damage
$\Delta C/C_0$	2% for MKT/MKP/MFP 5% for EMI suppression capacitors
$\tan \delta$	As specified in sectional specification



B32671Z ... B32676Z

**Power Factor Correction**

**1.3 General notes on soldering**

Permissible heat exposure loads on film capacitors are primarily characterized by the upper category temperature  $T_{max}$ . Long exposure to temperatures above this type-related temperature limit can lead to changes in the plastic dielectric and thus change irreversibly a capacitor's electrical characteristics. For short exposures (as in practical soldering processes) the heat load (and thus the possible effects on a capacitor) will also depend on other factors like:

- Pre-heating temperature and time
- Forced cooling immediately after soldering
- Terminal characteristics:  
diameter, length, thermal resistance, special configurations (e.g. crimping)
- Height of capacitor above solder bath
- Shadowing by neighboring components
- Additional heating due to heat dissipation by neighboring components
- Use of solder-resist coatings

The overheating associated with some of these factors can usually be reduced by suitable countermeasures. For example, if a pre-heating step cannot be avoided, an additional or reinforced cooling process may possibly have to be included.

**EPCOS recommendations**

As a reference, the recommended wave soldering profile for our film capacitors is as follows:

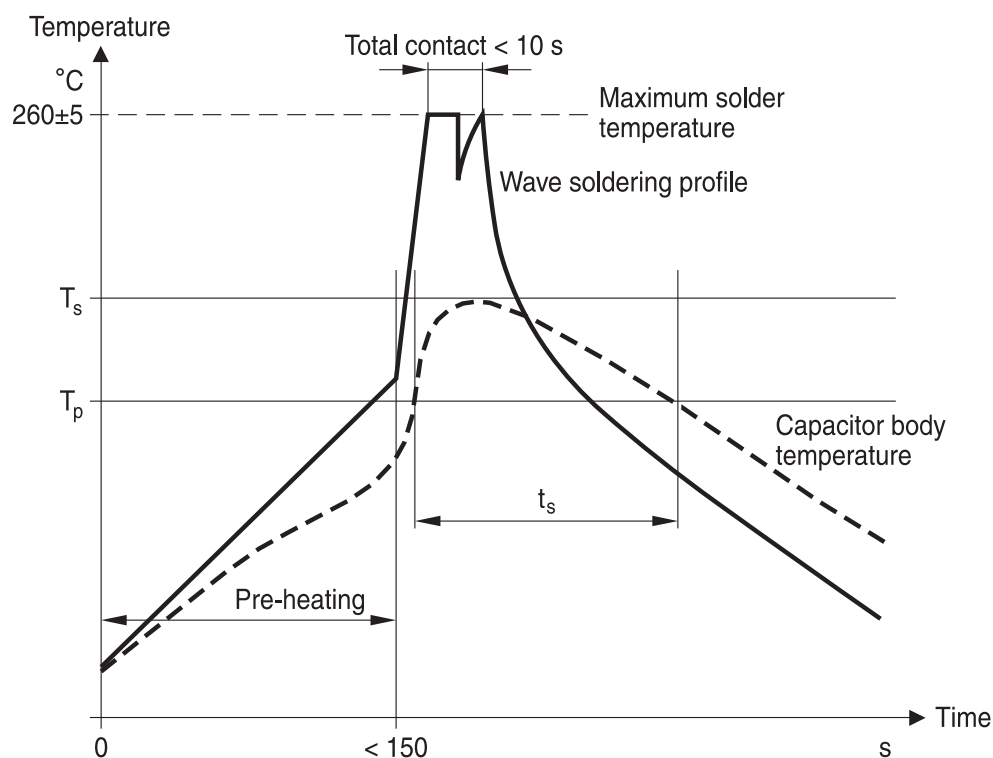

$T_s$ : Capacitor body maximum temperature at wave soldering

$T_p$ : Capacitor body maximum temperature at pre-heating

KMK1745-A-E

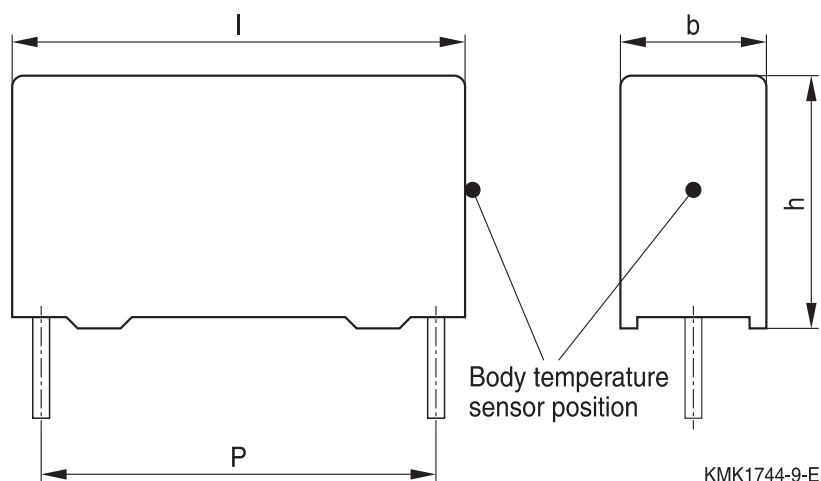

Body temperature should follow the description below:

- MKP capacitor
  - During pre-heating:  $T_p \leq 110 \text{ }^\circ\text{C}$
  - During soldering:  $T_s \leq 120 \text{ }^\circ\text{C}$ ,  $t_s \leq 45 \text{ s}$
- MKT capacitor
  - During pre-heating:  $T_p \leq 125 \text{ }^\circ\text{C}$
  - During soldering:  $T_s \leq 160 \text{ }^\circ\text{C}$ ,  $t_s \leq 45 \text{ s}$

When SMD components are used together with leaded ones, the film capacitors should not pass into the SMD adhesive curing oven. The leaded components should be assembled after the SMD curing step.

Leaded film capacitors are not suitable for reflow soldering.

In order to ensure proper conditions for manual or selective soldering, the body temperature of the capacitor ( $T_s$ ) must be  $\leq 120 \text{ }^\circ\text{C}$ .

One recommended condition for manual soldering is that the tip of the soldering iron should be  $< 360 \text{ }^\circ\text{C}$  and the soldering contact time should be no longer than 3 seconds.

For uncoated MKT capacitors with lead spacings  $\leq 10 \text{ mm}$  (B32560/B32561) the following measures are recommended:

- pre-heating to not more than  $110 \text{ }^\circ\text{C}$  in the preheater phase
- rapid cooling after soldering

Please refer to EPCOS Film Capacitor Data Book in case more details are needed.



B32671Z ... B32676Z

**Power Factor Correction**

**Cautions and warnings**

- Do not exceed the upper category temperature (UCT).
- Do not apply any mechanical stress to the capacitor terminals.
- Avoid any compressive, tensile or flexural stress.
- Do not move the capacitor after it has been soldered to the PC board.
- Do not pick up the PC board by the soldered capacitor.
- Do not place the capacitor on a PC board whose PTH hole spacing differs from the specified lead spacing.
- Do not exceed the specified time or temperature limits during soldering.
- Avoid external energy inputs, such as fire or electricity.
- Avoid overload of the capacitors.
- Consult us if application is with severe temperature and humidity condition.
- There are no serviceable or repairable parts inside the capacitor. Opening the capacitor or any attempts to open or repair the capacitor will void the warranty and liability of EPCOS.
- Please note that the standards referred to in this publication may have been revised in the meantime.

The table below summarizes the safety instructions that must always be observed. A detailed description can be found in the relevant sections of the chapters "General technical information" and "Mounting guidelines".

Topic	Safety information	Reference chapter "General technical information"
Storage conditions	Make sure that capacitors are stored within the specified range of time, temperature and humidity conditions.	4.5 "Storage conditions"
Flammability	Avoid external energy, such as fire or electricity (passive flammability), avoid overload of the capacitors (active flammability) and consider the flammability of materials.	5.3 "Flammability"
Resistance to vibration	Do not exceed the tested ability to withstand vibration. The capacitors are tested to IEC 60068-2-6:2007. EPCOS offers film capacitors specially designed for operation under more severe vibration regimes such as those found in automotive applications. Consult our catalog "Film Capacitors for Automotive Electronics".	5.2 "Resistance to vibration"

Topic	Safety information	Reference chapter "Mounting guidelines"
Soldering	Do not exceed the specified time or temperature limits during soldering.	1 "Soldering"
Cleaning	Use only suitable solvents for cleaning capacitors.	2 "Cleaning"





Topic	Safety information	Reference chapter "Mounting guidelines"
Embedding of capacitors in finished assemblies	When embedding finished circuit assemblies in plastic resins, chemical and thermal influences must be taken into account. Caution: Consult us first, if you also wish to embed other uncoated component types!	3 "Embedding of capacitors in finished assemblies"

### Display of ordering codes for EPCOS products

The ordering code for one and the same product can be represented differently in data sheets, data books, other publications and the website of EPCOS, or in order-related documents such as shipping notes, order confirmations and product labels. **The varying representations of the ordering codes are due to different processes employed and do not affect the specifications of the respective products.** Detailed information can be found on the Internet under [www.epcos.com/orderingcodes](http://www.epcos.com/orderingcodes).



B32671Z ... B32676Z

**Power Factor Correction**

**Symbols and terms**

Symbol	English	German
$\alpha$	Heat transfer coefficient	Wärmeübergangszahl
$\alpha_C$	Temperature coefficient of capacitance	Temperaturkoeffizient der Kapazität
A	Capacitor surface area	Kondensatoroberfläche
$\beta_C$	Humidity coefficient of capacitance	Feuchtekoeffizient der Kapazität
C	Capacitance	Kapazität
$C_R$	Rated capacitance	Nennkapazität
$\Delta C$	Absolute capacitance change	Absolute Kapazitätsänderung
$\Delta C/C$	Relative capacitance change (relative deviation of actual value)	Relative Kapazitätsänderung (relative Abweichung vom Ist-Wert)
$\Delta C/C_R$	Capacitance tolerance (relative deviation from rated capacitance)	Kapazitätstoleranz (relative Abweichung vom Nennwert)
dt	Time differential	Differentielle Zeit
$\Delta t$	Time interval	Zeitintervall
$\Delta T$	Absolute temperature change (self-heating)	Absolute Temperaturänderung (Selbsterwärmung)
$\Delta \tan \delta$	Absolute change of dissipation factor	Absolute Änderung des Verlustfaktors
$\Delta V$	Absolute voltage change	Absolute Spannungsänderung
dV/dt	Time differential of voltage function (rate of voltage rise)	Differentielle Spannungsänderung (Spannungsflankensteilheit)
$\Delta V/\Delta t$	Voltage change per time interval	Spannungsänderung pro Zeitintervall
E	Activation energy for diffusion	Aktivierungsenergie zur Diffusion
ESL	Self-inductance	Eigeninduktivität
ESR	Equivalent series resistance	Ersatz-Serienwiderstand
f	Frequency	Frequenz
$f_1$	Frequency limit for reducing permissible AC voltage due to thermal limits	Grenzfrequenz für thermisch bedingte Reduzierung der zulässigen Wechselspannung
$f_2$	Frequency limit for reducing permissible AC voltage due to current limit	Grenzfrequenz für strombedingte Reduzierung der zulässigen Wechselspannung
$f_r$	Resonant frequency	Resonanzfrequenz
$F_D$	Thermal acceleration factor for diffusion	Therm. Beschleunigungsfaktor zur Diffusion
$F_T$	Derating factor	Deratingfaktor
i	Current (peak)	Stromspitze
$I_C$	Category current (max. continuous current)	Kategoriestrom (max. Dauerstrom)



Symbol	English	German
$I_{RMS}$	(Sinusoidal) alternating current, root-mean-square value	(Sinusförmiger) Wechselstrom
$i_z$	Capacitance drift	Inkonstanz der Kapazität
$k_0$	Pulse characteristic	Impuls Kennwert
$L_S$	Series inductance	Serieninduktivität
$\lambda$	Failure rate	Ausfallrate
$\lambda_0$	Constant failure rate during useful service life	Konstante Ausfallrate in der Nutzungsphase
$\lambda_{test}$	Failure rate, determined by tests	Experimentell ermittelte Ausfallrate
$P_{diss}$	Dissipated power	Abgegebene Verlustleistung
$P_{gen}$	Generated power	Erzeugte Verlustleistung
$Q$	Heat energy	Wärmeenergie
$\rho$	Density of water vapor in air	Dichte von Wasserdampf in Luft
$R$	Universal molar constant for gases	Allg. Molarkonstante für Gas
$R$	Ohmic resistance of discharge circuit	Ohmscher Widerstand des Entladekreises
$R_i$	Internal resistance	Innenwiderstand
$R_{ins}$	Insulation resistance	Isolationswiderstand
$R_P$	Parallel resistance	Parallelwiderstand
$R_S$	Series resistance	Serienwiderstand
$S$	severity (humidity test)	Schärfegrad (Feuchtetest)
$t$	Time	Zeit
$T$	Temperature	Temperatur
$\tau$	Time constant	Zeitkonstante
$\tan \delta$	Dissipation factor	Verlustfaktor
$\tan \delta_D$	Dielectric component of dissipation factor	Dielektrischer Anteil des Verlustfaktors
$\tan \delta_P$	Parallel component of dissipation factor	Parallelanteil des Verlustfaktors
$\tan \delta_S$	Series component of dissipation factor	Serienanteil des Verlustfaktors
$T_A$	Temperature of the air surrounding the component	Temperatur der Luft, die das Bauteil umgibt
$T_{max}$	Upper category temperature	Obere Kategorietemperatur
$T_{min}$	Lower category temperature	Untere Kategorietemperatur
$t_{OL}$	Operating life at operating temperature and voltage	Betriebszeit bei Betriebstemperatur und -spannung
$T_{op}$	Operating temperature, $T_A + \Delta T$	Betriebstemperatur, $T_A + \Delta T$
$T_R$	Rated temperature	Nenntemperatur
$T_{ref}$	Reference temperature	Referenztemperatur
$t_{SL}$	Reference service life	Referenz-Lebensdauer



B32671Z ... B32676Z

**Power Factor Correction**

Symbol	English	German
$V_{AC}$	AC voltage	Wechselspannung
$V_C$	Category voltage	Kategorie <span>spannung</span>
$V_{C,RMS}$	Category AC voltage	(Sinusförmige) Kategorie-Wechselspannung
$V_{CD}$	Corona-discharge onset voltage	Teilentlade-Einsatzspannung
$V_{ch}$	Charging voltage	Ladespannung
$V_{DC}$	DC voltage	Gleichspannung
$V_{FB}$	Fly-back capacitor voltage	Spannung (Flyback)
$V_i$	Input voltage	Eingangsspannung
$V_o$	Output voltage	Ausgangsspannung
$V_{op}$	Operating voltage	Betriebsspannung
$V_p$	Peak pulse voltage	Impuls-Spitzen <span>spannung</span>
$V_{pp}$	Peak-to-peak voltage Impedance	Spannungshub
$V_R$	Rated voltage	Nennspannung
$\hat{V}_R$	Amplitude of rated AC voltage	Amplitude der Nenn-Wechselspannung
$V_{RMS}$	(Sinusoidal) alternating voltage, root-mean-square value	(Sinusförmige) Wechselspannung
$V_{SC}$	S-correction voltage	Spannung bei Anwendung "S-correction"
$V_{sn}$	Snubber capacitor voltage	Spannung bei Anwendung "Beschaltung"
$Z$	Impedance	Scheinwiderstand
$e$	Lead spacing	Rastermaß

## Important notes

The following applies to all products named in this publication:

1. Some parts of this publication contain **statements about the suitability of our products for certain areas of application**. These statements are based on our knowledge of typical requirements that are often placed on our products in the areas of application concerned. We nevertheless expressly point out **that such statements cannot be regarded as binding statements about the suitability of our products for a particular customer application**. As a rule, EPCOS is either unfamiliar with individual customer applications or less familiar with them than the customers themselves. For these reasons, it is always ultimately incumbent on the customer to check and decide whether an EPCOS product with the properties described in the product specification is suitable for use in a particular customer application.
2. We also point out that **in individual cases, a malfunction of electronic components or failure before the end of their usual service life cannot be completely ruled out in the current state of the art, even if they are operated as specified**. In customer applications requiring a very high level of operational safety and especially in customer applications in which the malfunction or failure of an electronic component could endanger human life or health (e.g. in accident prevention or lifesaving systems), it must therefore be ensured by means of suitable design of the customer application or other action taken by the customer (e.g. installation of protective circuitry or redundancy) that no injury or damage is sustained by third parties in the event of malfunction or failure of an electronic component.
3. **The warnings, cautions and product-specific notes must be observed.**
4. In order to satisfy certain technical requirements, **some of the products described in this publication may contain substances subject to restrictions in certain jurisdictions (e.g. because they are classed as hazardous)**. Useful information on this will be found in our Material Data Sheets on the Internet ([www.epcos.com/material](http://www.epcos.com/material)). Should you have any more detailed questions, please contact our sales offices.
5. We constantly strive to improve our products. Consequently, **the products described in this publication may change from time to time**. The same is true of the corresponding product specifications. Please check therefore to what extent product descriptions and specifications contained in this publication are still applicable before or when you place an order. We also **reserve the right to discontinue production and delivery of products**. Consequently, we cannot guarantee that all products named in this publication will always be available. The aforementioned does not apply in the case of individual agreements deviating from the foregoing for customer-specific products.
6. Unless otherwise agreed in individual contracts, **all orders are subject to the current version of the "General Terms of Delivery for Products and Services in the Electrical Industry" published by the German Electrical and Electronics Industry Association (ZVEI)**.

## Important notes

7. **Our manufacturing sites serving the automotive business apply the IATF 16949 standard.** The IATF certifications confirm our compliance with requirements regarding the quality management system in the automotive industry. Referring to customer requirements and customer specific requirements (“CSR”) TDK always has and will continue to have the policy of respecting individual agreements. Even if IATF 16949 may appear to support the acceptance of unilateral requirements, we hereby like to emphasize that **only requirements mutually agreed upon can and will be implemented in our Quality Management System.** For clarification purposes we like to point out that obligations from IATF 16949 shall only become legally binding if individually agreed upon.
8. The trade names EPCOS, CeraCharge, CeraDiode, CeraLink, CeraPad, CeraPlas, CSMP, CTVS, DeltaCap, DigiSiMic, ExoCore, FilterCap, FormFit, LeaXield, MiniBlue, MiniCell, MKD, MKK, MotorCap, PCC, PhaseCap, PhaseCube, PhaseMod, PhiCap, PowerHap, PQSine, PQvar, SIFERRIT, SIFI, SIKOREL, SilverCap, SIMDAD, SiMic, SIMID, SineFormer, SIOV, ThermoFuse, WindCap are **trademarks registered or pending** in Europe and in other countries. Further information will be found on the Internet at [www.epcos.com/trademarks](http://www.epcos.com/trademarks).

Release 2018-06

# Mouser Electronics

Authorized Distributor

Click to View Pricing, Inventory, Delivery & Lifecycle Information:

## EPCOS / TDK:

[B32672Z4105K189](#) [B32673Z4225K](#) [B32673Z4334K](#) [B32673Z4474K](#) [B32673Z4684K](#) [B32672Z4105K](#)  
[B32672Z4224K](#) [B32672Z4474K](#) [B32672Z4684K](#) [B32672Z5224K189](#) [B32672Z5334J](#) [B32672Z5334K](#)  
[B32673Z5105K](#) [B32673Z5684K](#) [B32672Z6393J289](#) [B32671Z4154K289](#) [B32672Z5474K189](#) [B32672Z6104K189](#)  
[B32672Z5154K189](#) [B32672Z4474K189](#) [B32673Z5105K189](#) [B32672Z6474K189](#) [B32673Z6474K189](#)  
[B32673Z6105K189](#) [B32672Z5105K189](#) [B32673Z6225K](#) [B32673Z4105K](#) [B32672Z4105J](#) [B32672Z6564J](#)  
[B32672Z6474K](#) [B32672Z6474J](#) [B32673Z6105K](#) [B32673Z6474K](#) [B32672Z6683K](#) [B32673Z6105J](#) [B32672Z5104K](#)  
[B32672Z6473J](#) [B32672Z6683J](#) [B32672Z5104J](#) [B32672Z4684J](#) [B32672Z6104K](#) [B32673Z6334J](#) [B32672Z4154K](#)  
[B32673Z6474J](#) [B32673Z6684K](#) [B32673Z5474J](#) [B32673Z6155K](#) [B32673Z6684J](#) [B32672T6224K000](#)  
[B32672Z4564K000](#)

## TDK:

[B32672Z6224J189](#)

Компания «Океан Электроники» предлагает заключение долгосрочных отношений при поставках импортных электронных компонентов на взаимовыгодных условиях!

Наши преимущества:

- Поставка оригинальных импортных электронных компонентов напрямую с производств Америки, Европы и Азии, а так же с крупнейших складов мира;
- Широкая линейка поставок активных и пассивных импортных электронных компонентов (более 30 млн. наименований);
- Поставка сложных, дефицитных, либо снятых с производства позиций;
- Оперативные сроки поставки под заказ (от 5 рабочих дней);
- Экспресс доставка в любую точку России;
- Помощь Конструкторского Отдела и консультации квалифицированных инженеров;
- Техническая поддержка проекта, помощь в подборе аналогов, поставка прототипов;
- Поставка электронных компонентов под контролем ВП;
- Система менеджмента качества сертифицирована по Международному стандарту ISO 9001;
- При необходимости вся продукция военного и аэрокосмического назначения проходит испытания и сертификацию в лаборатории (по согласованию с заказчиком);
- Поставка специализированных компонентов военного и аэрокосмического уровня качества (Xilinx, Altera, Analog Devices, Intersil, Interpoint, Microsemi, Actel, Aeroflex, Peregrine, VPT, Syfer, Eurofarad, Texas Instruments, MS Kennedy, Miteq, Cobham, E2V, MA-COM, Hittite, Mini-Circuits, General Dynamics и др.);

Компания «Океан Электроники» является официальным дистрибьютором и эксклюзивным представителем в России одного из крупнейших производителей разъемов военного и аэрокосмического назначения «JONHON», а так же официальным дистрибьютором и эксклюзивным представителем в России производителя высокотехнологичных и надежных решений для передачи СВЧ сигналов «FORSTAR».



## JONHON

«JONHON» (основан в 1970 г.)

Разъемы специального, военного и аэрокосмического назначения:

(Применяются в военной, авиационной, аэрокосмической, морской, железнодорожной, горно- и нефтедобывающей отраслях промышленности)

«FORSTAR» (основан в 1998 г.)

ВЧ соединители, коаксиальные кабели, кабельные сборки и микроволновые компоненты:

(Применяются в телекоммуникациях гражданского и специального назначения, в средствах связи, РЛС, а так же военной, авиационной и аэрокосмической отраслях промышленности).



Телефон: 8 (812) 309-75-97 (многоканальный)

Факс: 8 (812) 320-03-32

Электронная почта: [ocean@oceanchips.ru](mailto:ocean@oceanchips.ru)

Web: <http://oceanchips.ru/>

Адрес: 198099, г. Санкт-Петербург, ул. Калинина, д. 2, корп. 4, лит. А