

Single-chip Type with Built-in FET Switching Regulator Series

# Simple Step-down Switching Regulators with Built-in Power MOSFET

**BD9701FP/CP-V5/T/T-V5, BD9703FP/CP-V5/T/T-V5, BD9702CP-V5/T/T-V5**

No.09027EBT01

**●Description**

The BD9701/BD9703/BD9702 are single-channel step-down switching regulator capable of PWM operation.

The Pch MOS FET is built in for high efficiency in small load area. Lower electricity consumption of operating current 4mA (Typ) and stand-by current 0uA(Typ) is realized by adopting Bi-CMOS process.

**●Features**

- 1) Maximum switching current: 1.5A(BD9701/BD9703), 3A(BD9702)
- 2) Built-in Pch FET ensures high efficiency
- 3) Output voltage adjustable via external resistors
- 4) High switching frequency: 100kHz (BD9701), 300kHz(BD9703), 110kHz(BD9702)
- 5) Overcurrent and thermal shutdown protection circuits built in
- 6) ON/OFF control via STBY pin
- 7) Small surface mount TO252-5 package (only BD9701FP, BD9703FP)

**●Applications**

TVs, printers, DVD players, projectors, gaming devices, PCs, car audio/navigation systems, ETCs, communication equipment, AV products, office equipment, industrial devices, and more.

**●Line Up**

	BD9701FP/CP-V5/T/T-V5	BD9703FP/CP-V5/T/T-V5	BD9702CP-V5/T/T-V5
Output Current	1.5A		3.0A
Input Voltage	8 or $V_o+3 \sim 36V$		
Switching Frequency	100kHz (fixed)	300kHz (fixed)	110kHz (fixed)
External Synchronization	×		
Stand-by Function	○		
Operating Temperature	-40 $\sim$ +85°C		
Package	TO252-5/TO220CP-V5/TO220FP-5/TO220FP-5 (V5)		TO220CP-V5/TO220FP-5/TO220FP-5 (V5)

## ● Absolute Maximum Ratings (Ta=25°C)

Parameter	Symbol	Ratings	Unit
Supply Voltage (VCC-GND)	VCC	36	V
STBY-GND	V <sub>STBY</sub>	36	V
OUT-GND	V <sub>O</sub>	36	V
INV-GND	V <sub>INV</sub>	10	V
Maximum Switching Current	BD9701/BD9703	1.5	A
	BD9702	3	
Power Dissipation	TO252	0.8 <sup>(*)1</sup>	W
	TO220	2 <sup>(*)2</sup>	
Operating Temperature	Topr	-40~+85	°C
Storage Temperature	Tstg	-55~+150	°C

\*1 Without external heat sink, the power dissipation reduces by 6.4mW/°C over 25°C.

\*2 Without external heat sink, the power dissipation reduces by 16.0mW/°C over 25°C.

Reduced by 160mW/°C, when mounted on Infinity size heatsink.

## ● Operating Conditions (Ta=-40~+85°C)

Parameter	Symbol	Limit			Unit
		MIN	TYP	MAX	
Input Voltage	VCC	8.0 or Vo+3 <sup>(*)3</sup>	-	35.0	V
Output Voltage	Vo	1.0	-	32	V

\*3 The minimum value of an input voltage is the higher either 8.0V or Vo+3

## ● Electrical Characteristics

OBD9701FP/CP-V5/T/T-V5 (Unless otherwise noted, Ta=25°C, VCC=12V, Vo=5V, STBY=3V)

Parameter	Symbol	Limit			Unit	Conditions	
		MIN	TYP	MAX			
Output ON Resistance	Ron	-	1.0	1.5	Ω	design guarantee	
Efficiency	η	-	86	-	%	Io=0.5A design guarantee	
Switching Frequency	fosc	80	100	120	kHz		
Load Regulation	ΔVOLOAD	-	10	40	mV	VCC=20V, Io=0.5~1.5A	
Line Regulation	ΔVOLINE	-	40	100	mV	VCC=10~30V, Io=1.0A	
Over Current Protection Limit	Iocp	1.6	-	-	A		
INV Pin Threshold Voltage	VINV	0.98	1.00	1.02	V		
INV Pin Threshold Voltage Thermal Variation	ΔVINV	-	±0.5	-	%	Tj=0~85°C design guarantee	
INV Pin Input Current	IINV	-	1	-	μA	VINV=1.0V	
STBY Pin Threshold Voltage	ON	VSTBYON	2.0	-	36	V	
	OFF	VSTBYOFF	-0.3	-	0.3	V	
STBY Pin Input Current	Istby	5	25	50	μA	STBY=3V	
Circuit Current	Icc	-	4	12	mA		
Stand-by Current	Ist	-	0	5	μA	STBY=0V	

This product is not designed to be resistant to radiation.

## ●Electrical Characteristics

OBD9703FP/CP-V5/T/T-V5 (Unless otherwise noted, Ta=25°C, VCC=12V, Vo=5V, STBY=3V)

Parameter	Symbol	Limit			Unit	Conditions	
		MIN	TYP	MAX			
Output ON Resistance	Ron	-	1.0	1.5	Ω	design guarantee	
Efficiency	η	-	86	-	%	Io=0.5A design guarantee	
Switching Frequency	fosc	270	300	330	kHz		
Load Regulation	ΔVOLOAD	-	10	40	mV	VCC=20V, Io=0.5~1.5A	
Line Regulation	ΔVOLINE	-	40	100	mV	VCC=10~30V, Io=1.0A	
Over Current Protection Limit	Iocp	1.6	-	-	A		
INV Pin Threshold Voltage	VINV	0.98	1.00	1.02	V		
INV Pin Threshold Voltage Thermal Variation	ΔVINV	-	±0.5	-	%	Tj=0~85°C design guarantee	
INV Pin Input Current	IINV	-	1	-	μA	VINV=1.0V	
STBY Pin Threshold Voltage	ON	VSTBYON	2.0	-	36	V	
	OFF	VSTBYOFF	-0.3	-	0.3	V	
STBY Pin Input Current	Istby	5	25	50	μA	STBY=3V	
Circuit Current	Icc	-	5	12	mA		
Stand-by Current	Ist	-	0	5	μA	STBY=0V	

## ●Electrical Characteristics

OBD9702FP/CP-V5/T/T-V5 (Unless otherwise noted, Ta=25°C, VCC=12V, Vo=5V, STBY=3V)

Parameter	Symbol	Limit			Unit	Conditions	
		MIN	TYP	MAX			
Output ON Resistance	Ron	-	0.5	1.5	Ω	design guarantee	
Efficiency	η	-	86	-	%	Io=1A design guarantee	
Switching Frequency	fosc	88	110	132	kHz		
Load Regulation	ΔVOLOAD	-	10	40	mV	VCC=20V, Io=1~3A	
Line Regulation	ΔVOLINE	-	40	100	mV	VCC=10~30V, Io=1.0A	
Over Current Protection Limit	Iocp	3.2	-	-	A		
INV Pin Threshold Voltage	VINV	0.98	1.00	1.02	V		
INV Pin Threshold Voltage Thermal Variation	ΔVINV	-	±0.5	-	%	Tj=0~85°C design guarantee	
INV Pin Input Current	IINV	-	1	-	μA	VINV=1.0V	
STBY Pin Threshold Voltage	ON	VSTBYON	2.0	-	36	V	
	OFF	VSTBYOFF	-0.3	-	0.3	V	
STBY Pin Input Current	Istby	5	25	50	μA	STBY=3V	
Circuit Current	Icc	-	4	12	mA		
Stand-by Current	Ist	-	0	5	μA	STBY=0V	

● Characteristic Data  
 ○ BD9701FP/CP-V5/T/T-V5

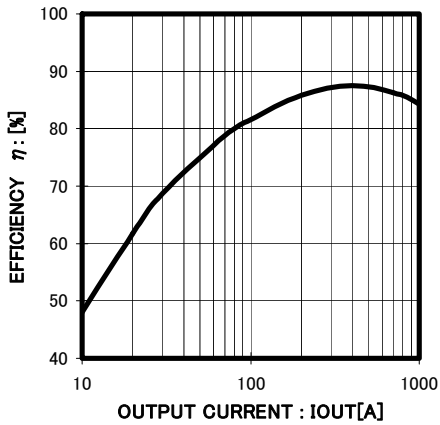

Fig.1  
 EFFICIENCY-LOAD CURRENT

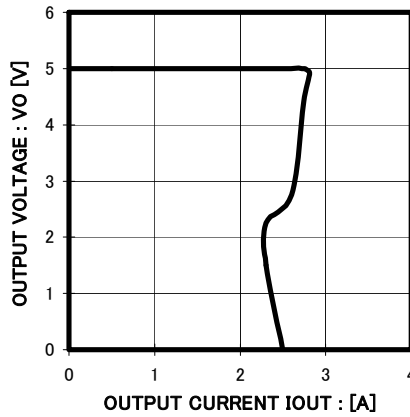

Fig.2  
 OCP VCC=20V

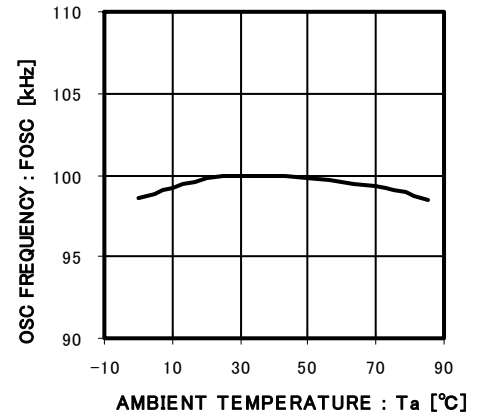

Fig.3  
 fosc-Ta

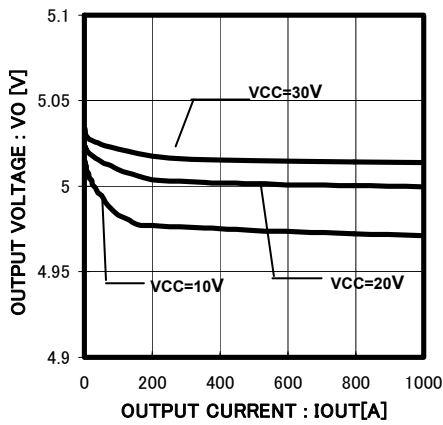

Fig.4  
 OUTPUT VOLTAGE-LOAD CURRENT

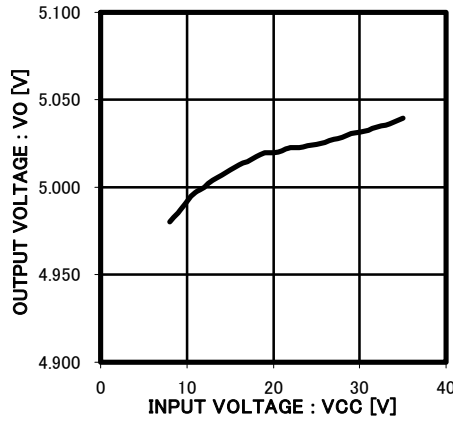

Fig.5  
 OUTPUT VOLTAGE-INPUT VOLTAGE  
 (Vo=5V, Ro=5ohm)

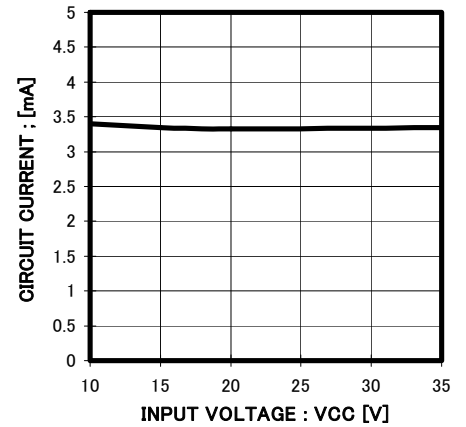

Fig.6  
 CIRCUIT CURRENT-INPUT VOLTAGE  
 NO LOAD

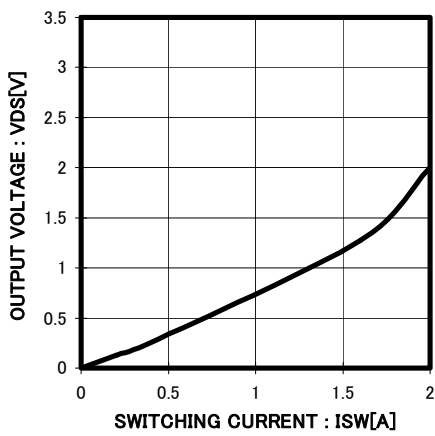

Fig.7  
 VOUT~OUT VOLTAGE-DRAIN CURRENT

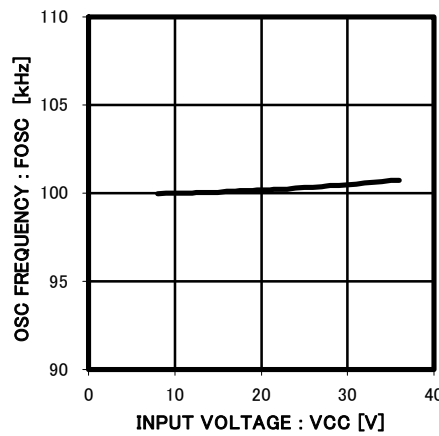

Fig.8  
 fosc-INPUT VOLTAGE

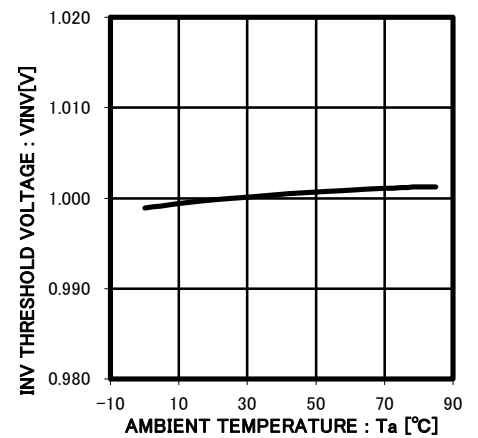

Fig.9  
 INV THRESHOLD VOLTAGE-Ta

● Characteristic Data  
○ BD9702FP/CP-V5/T/T-V5

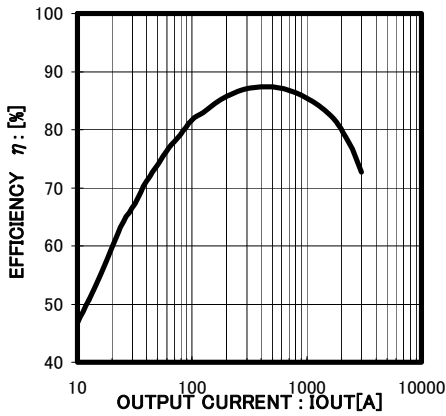

Fig. 10  
EFFICIENCY-LOAD CURRENT

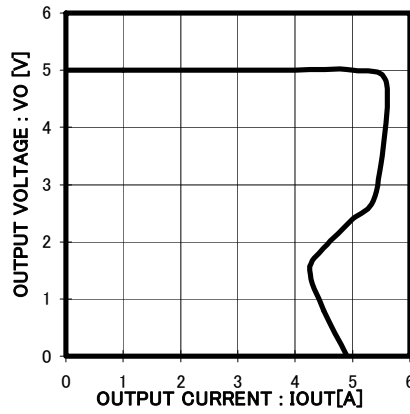

Fig. 11  
OCP VCC=20V

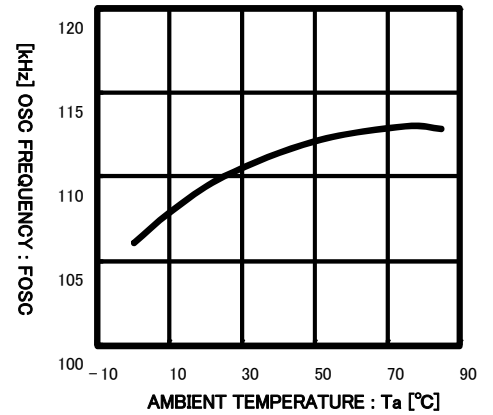

Fig. 12  
fosc-Ta

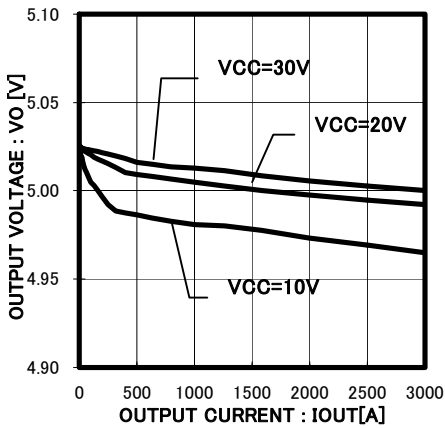

Fig. 13  
OUTPUT VOLTAGE-LOAD CURRENT

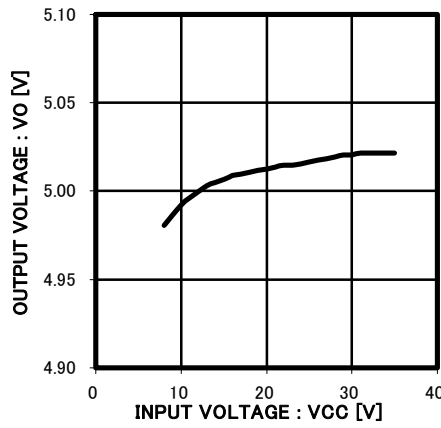

Fig. 14  
OUTPUT VOLTAGE-INPUT VOLTAGE  
(Vo=5V, Ro=5ohm)

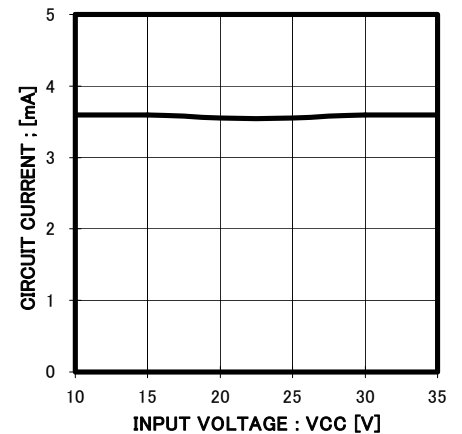

Fig. 15  
CIRCUIT CURRENT-  
INPUT VOLTAGE NO LOAD

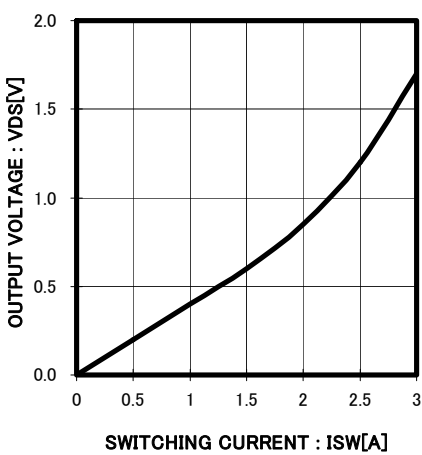

Fig. 16  
VOUT~OUT VOLTAGE-DRAIN CURRENT

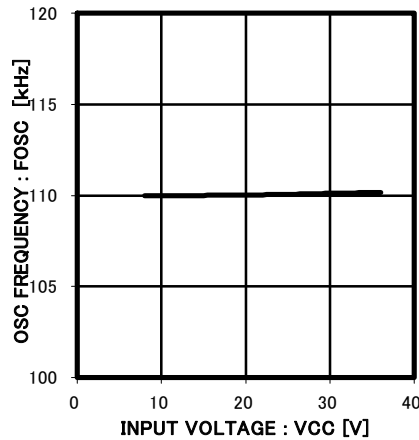

Fig. 17  
fosc-INPUT VOLTAGE

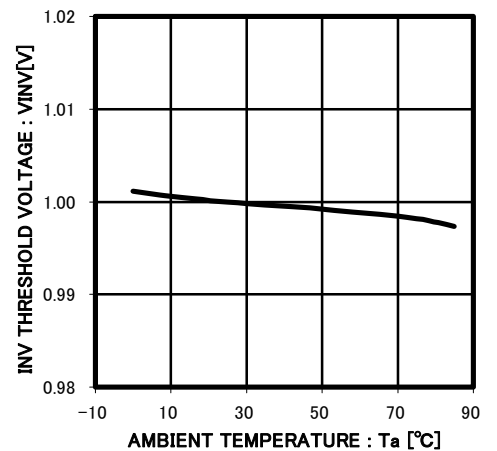

Fig. 18  
INV THRESHOLD VOLTAGE-Ta

● Characteristic Data  
○ OBD9703FP/CP-V5/T/T-V5

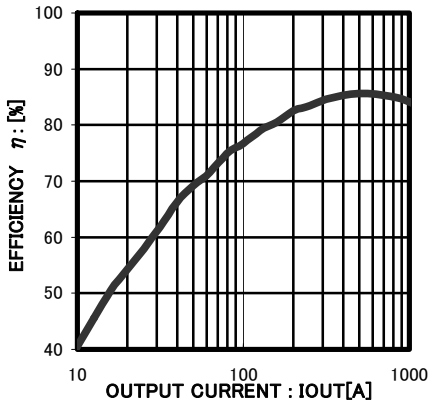

Fig.19  
EFFICIENCY-LOAD CURRENT

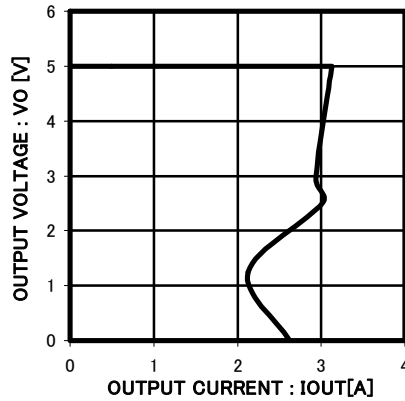

Fig.20  
OCP VCC=20V

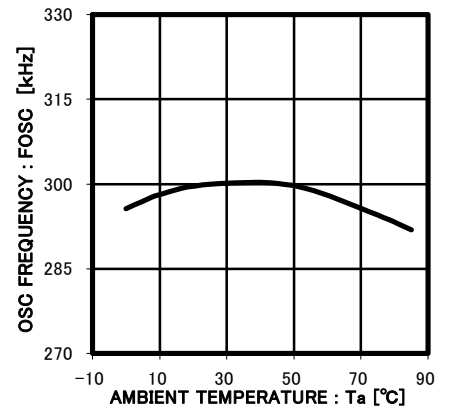

Fig.21  
fosc-Ta

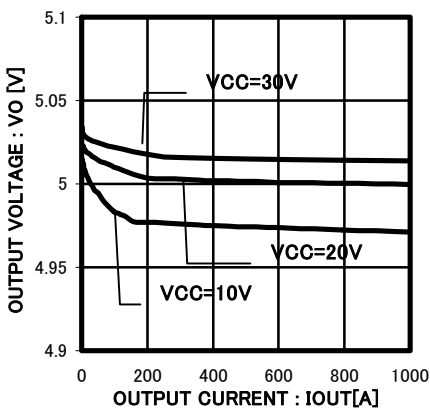

Fig.22  
OUTPUT VOLTAGE-LOAD CURRENT

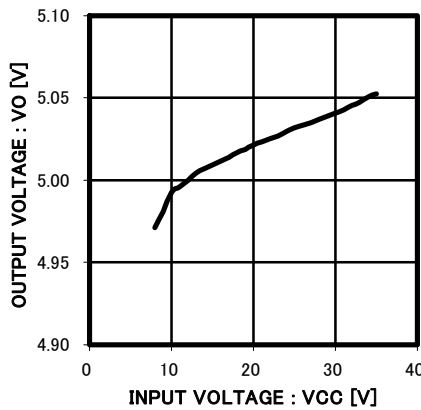

Fig.23  
OUTPUT VOLTAGE-INPUT VOLTAGE (Vo=5V, Ro=5ohm)

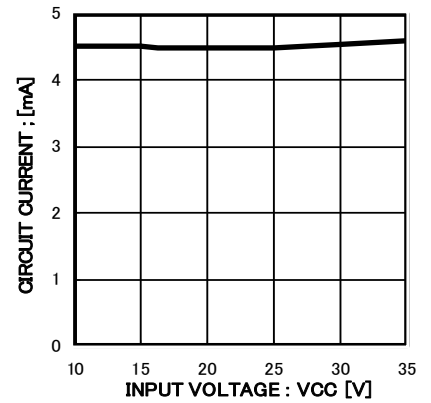

Fig.24  
CIRCUIT CURRENT-INPUT VOLTAGE NO LOAD

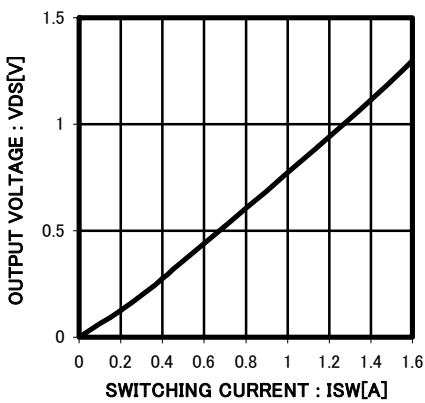

Fig.25  
VOUT~OUT VOLTAGE-DRAIN CURRENT

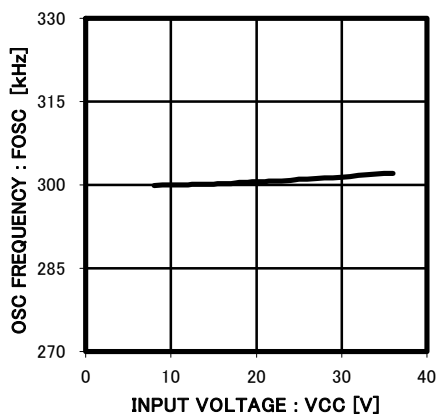

Fig.26  
fosc-INPUT VOLTAGE

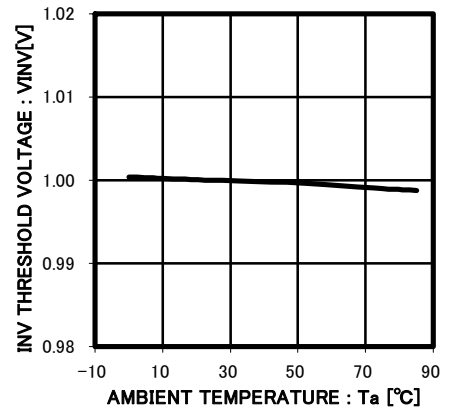

Fig.27  
INV THRESHOLD VOLTAGE-Ta



### ●Block Function Explanations

- VREF  
Generates the regulated voltage from VCC input, compensated for temperature.
- OSC  
Generates the triangular wave oscillation frequency using an internal resistors and capacitor. Used for PWM comparator input.
- Error AMP  
This block, via the INV pin, detects the resistor-divided output voltage, compares this with the reference voltage, then amplifies and outputs the difference.
- PWM COMP  
Outputs PWM signals to the Driver block, which converts the error amp output voltage to PWM form.
- DRIVER  
This push-pull FET driver powers the internal Pch MOSFET, which accepts direct PWM input.
- STBY  
Controls ON/OFF operation via the STBY pin. The output is ON when STBY is High.
- Thermal Shutdown (TSD)  
This circuit protects the IC against thermal runaway and damage due to excessive heat. A thermal sensor detects the junction temperature and switches the output OFF once the temperature exceeds a threshold value (175deg). Hysteresis is built in (15deg) in order to prevent malfunctions due to temperature fluctuations.
- Over Current Protection (OCP)  
The OCP circuit detects the voltage difference between VCC and OUT by measuring the current through the internal Pch MOSFET and switches the output OFF once the voltage reaches the threshold value. The OCP block is a self-recovery type (not latch).

### ●Timing Chart

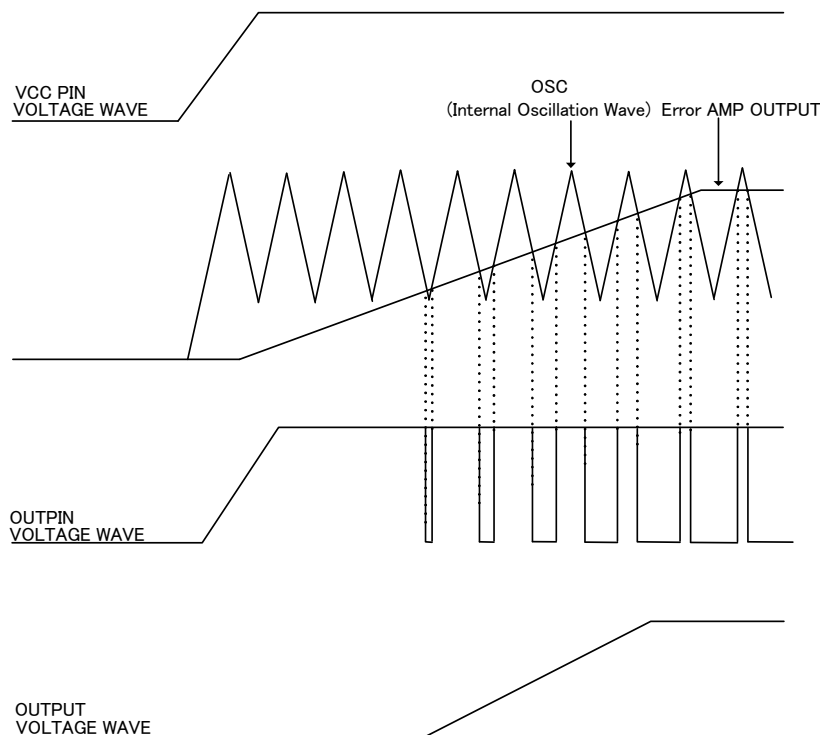

Fig.29 Timing Chart



●Notes for PCB layout

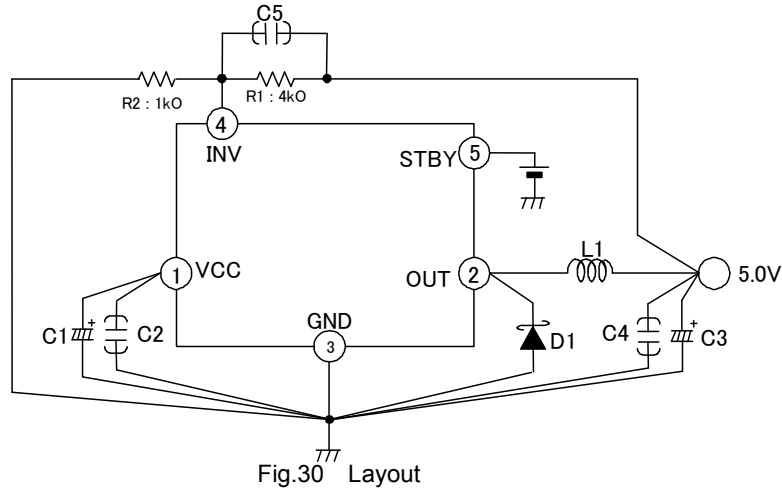

Fig.30 Layout

- Place capacitors between VCC and Ground, and the Schottky diode as close as possible to the IC to reduce noise and maximize efficiency.
- Connect resistors between INV and Ground, and the output capacitor filter at the same Ground potential in order to stabilize the output voltage.

●Application component selection and settings

**Inductor L1**

If the winding resistance of the choke coil is too high, the efficiency may deteriorate.

As the overcurrent protection operates over minimum 1.6A (BD9701FP/CP-V5/T/T-V5, BD9703FP/CP-V5/T/V5) or 3.2A minimum (BD9701CP-V5/T/T-V5), attention must be paid to the heating of the inductor due to overload of short-circulated load.

Note that the current rating for the coil should be higher than  $I_{OUT}(MAX) + \Delta I_L$ .  $I_{out}(MAX)$ : maximum load current  
If you flow more than maximum current rating, coil will become overload, and cause magnetic saturation, and those account for efficiency deterioration. Select from enough current rating of coil which doesn't over peak current.

$$\Delta I_L = \frac{(VCC - VOUT)}{L1} \times \frac{VOUT}{VCC} \times \frac{1}{fosc}$$

L1: inductor value, VCC: maximum input voltage, VOUT: output voltage,  $\Delta I_L$ : coil ripple current value, fosc: oscillation frequency

**Schottky Barrier Diodes D1**

A Schottky diode with extremely low forward voltage should be used. Selection should be based on the following guidelines regarding maximum forward current, reverse voltage, and power dissipation:

- The maximum current rating is higher than the combined maximum load current and coil ripple current ( $\Delta I_L$ ).
- The reverse voltage rating is higher than the VIN value.
- Power dissipation for the selected diode must be within the rated level.

The power dissipation of the diode is expressed by the following formula:

$$P_{di} = I_{out}(MAX) \times V_f \times (1 - VOUT/VCC)$$

$I_{out}(MAX)$ : maximum load current,  $V_f$ : forward voltage, VOUT: output voltage, VCC: input voltage

**Capacitor C1, C2, C3, C4, C5**

As large ripple currents flow across C1 and C3 capacitors, high frequency and low impedance capacitor for a switching regulator must be used. The ceramic capacitor C2 must be connected. If not, noise may cause an abnormal operation. If the ripple voltage of input and output is large, C4 selected among ceramic, tantalum and OS capacitor with low ESR may decrease the ripple, however if the only low ESR capacitor is used, an oscillation or unstable operation may be caused. C5 is the capacitor for phase compensation and normally not used. If you need to improve the stability of feedback network, connect C5 between INV and OUTPUT.

**Feed back resistance R1, R2**

The offset of output voltage is determined by both Feed back resistance and INV pin input current.

$$VOUT = (R1 + R2) \cdot I_{INV} / R2 \quad (I_{INV} \text{ pin Threshold Voltage})$$

If Feed back resistance is high, the setting of output voltage will be move.

Recommended : Resistance between INV pin and GND = less than 10kΩ.

●Recommended Circuit

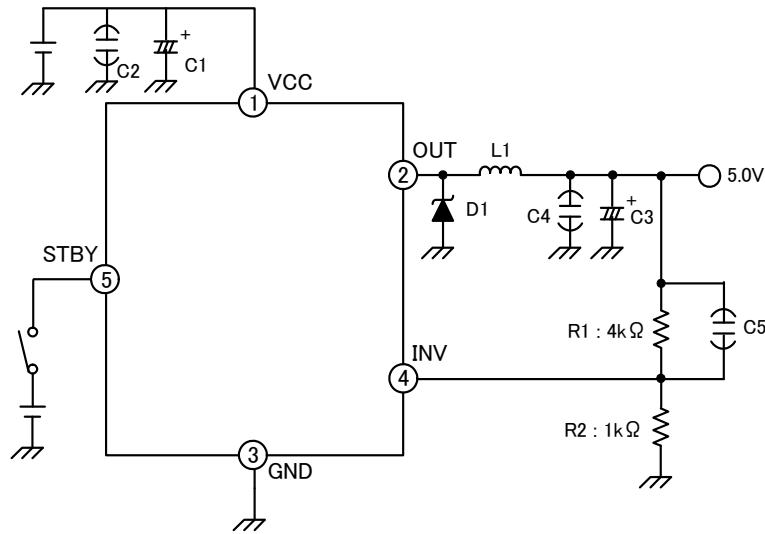

Fig.31 Recommended Circuit Output Voltage 5V : Application circuit example

(BD9701FP/CP-V5/T/T-V5)

<Recommended Components (Example)>

Inductor	L1=100μH	:CDRH127/LD (sumida)
Schottky Diode	D1	:RB050LA-40 (ROHM)
Capacitor	C1=100μF(50V)	:Al electric capacitor UHD1H101MPT (nichicon)
	C2=OPEN	
	C3=220μF(25V)	:Al electric capacitor UHD1E221MPT (nichicon)
	C4=OPEN	
	C5=OPEN	

<Recommended Components example 2>

Inductor	L1=100μH	:CDRH127/LD (sumida)
Schottky Diode	D1	:RB050LA-40 (ROHM)
Capacitor	C1=220μF(25V)	:Al electric capacitor UVR1H221MPA (nichicon)
	C2=1.0μF(50V)	:ceramic cap UMK212F105ZG (TAIYO YUDEN)
	C3=470μF(16V)	:Al electric capacitor UVR1E471MPA (nichicon)
	C4=150μF(20V)	:OS capacitor 20SVP150M (SANYO)
	C5=OPEN	

(BD9703FP/CP-V5/T/T-V5)

<Recommended Components>

Inductor	L1=47 $\mu$ H	:CDRH127/LD (sumida)
Schotky Diode	D1	:RB050LA-40 (ROHM)
Capacitor	C1=100 $\mu$ F(50V)	:Al electric capacitor UHD1H101MPT (nichicon)
	C2=2.2 $\mu$ F(50V)	:ceramic cap CM43X7R225K50A (KYOCERA)
	C3=470 $\mu$ F(25V)	:Al electric capacitor UHD1E471MPT (nichicon)
	C4=OPEN	
	C3=OPEN	

(BD9702CP-V5/T/T-V5)

<Recommended Components>

Inductor	L1=47 $\mu$ H	:CDRH127/LD (sumida)
Schotky Diode	D1	:RB050LA-40 (ROHM)
Capacitor	C1=1000 $\mu$ F(50V)	:Al electric capacitor UHD1H102MPT (nichicon)
	C2=OPEN	
	C3=1000 $\mu$ F(25V)	:Al electric capacitor UHD1E102MPT (nichicon)
	C4=OPEN	
	C3=OPEN	

● Test Circuit

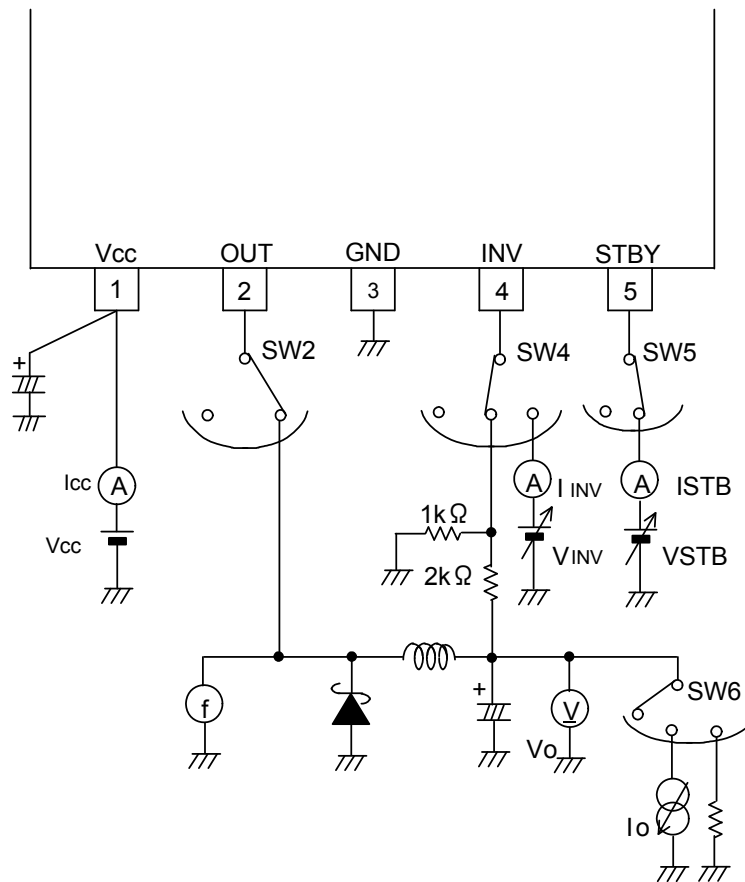

Fig.32 Input Output Measurement Circuit

● I/O Equivalent Circuit

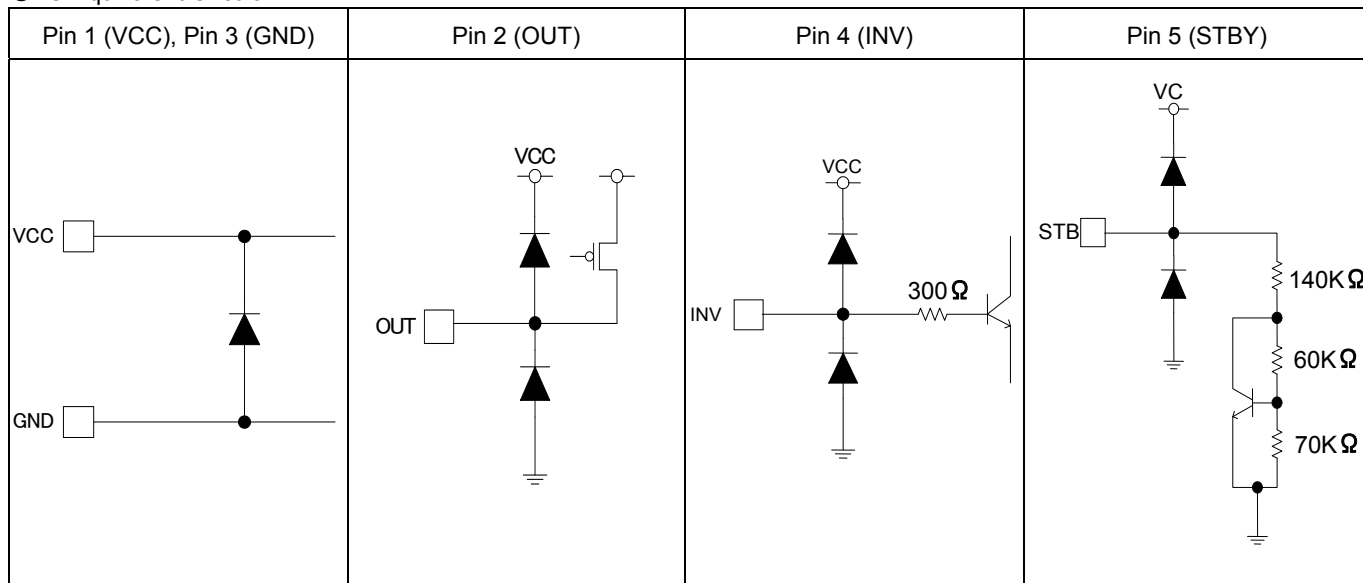

Fig.33 Input Output Equivalent Circuit

● Notes for use

1. Absolute Maximum Ratings

Use of the IC in excess of absolute maximum ratings such as the applied voltage or operating temperature range may result in IC deterioration or damage. Assumptions should not be made regarding the state of the IC (short mode or open mode) when such damage is suffered. A physical safety measure such as a fuse should be implemented when use of the IC in a special mode where the absolute maximum ratings may be exceeded is anticipated.

2. GND voltage

Ensure a minimum GND pin potential in all operating conditions. In addition, ensure that no pins other than the GND pin carry a voltage lower than or equal to the GND pin, including during actual transient phenomena.

3. Thermal design

Use a thermal design that allows for a sufficient margin in light of the power dissipation (Pd) in actual operating conditions.

4. Inter-pin shorts and mounting errors

Use caution when orienting and positioning the IC for mounting on printed circuit boards. Improper mounting may result in damage to the IC. Shorts between output pins or between output pins and the power supply and GND pin caused by the presence of a foreign object may result in damage to the IC.

5. Operation in strong electromagnetic field

Operation in a strong electromagnetic field may cause malfunction.

6. Thermal shutdown circuit (TSD circuit)

This IC incorporates a built-in thermal shutdown circuit (TSD circuit). The TSD circuit is designed only to shut the IC off to prevent runaway thermal operation. Do not continue to use the IC after operating this circuit or use the IC in an environment where the operation of the thermal shutdown circuit is assumed.

7. Testing on application boards

When testing the IC on an application board, connecting a capacitor to a pin with low impedance subjects the IC to stress. Always discharge capacitors after each process or step. Ground the IC during assembly steps as an antistatic measure, and use similar caution when transporting or storing the IC. Always turn the IC's power supply off before connecting it to or removing it from a jig or fixture during the inspection process.

8. IC pin input

This IC is a monolithic IC which (as below) has P+ substrate and between the various pin. A P-N junction is formed from this P layer of each pin. For example the relation between each potential is as follows. (When  $GND > PinB$  and  $GND > PinA$ , the P-N junction operates as a parasitic diode.) Parasitic diodes can occur inevitably in the structure of the IC. The operation of parasitic diodes can result in mutual interference among circuits as well as operation faults and physical damage. Accordingly, you must not use methods by which parasitic diodes operate, such as applying a voltage that is lower than the GND(P substrate)voltage to an input pin.

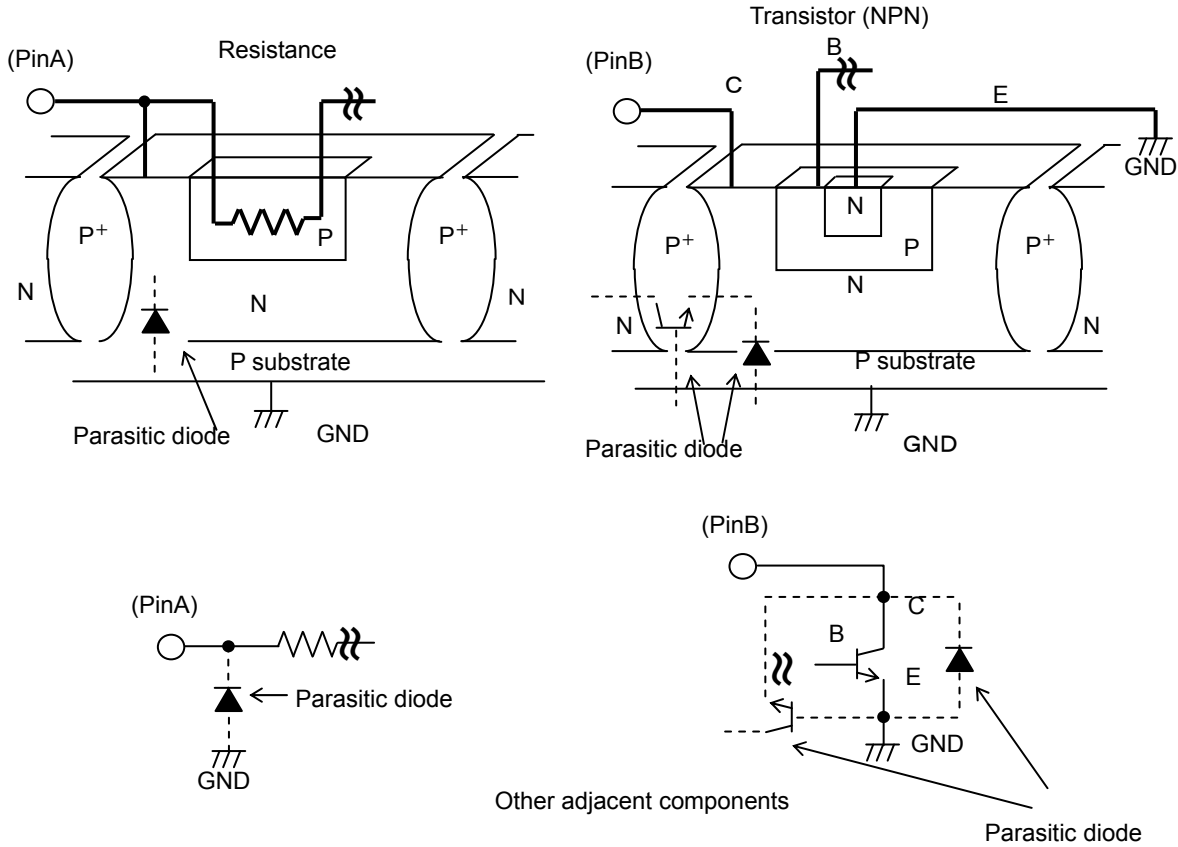

Fig.34 Simplified structure of a Bipolar IC

9. Common impedance

Power supply and ground wiring should reflect consideration of the need to lower common impedance and minimize ripple as much as possible (by making wiring as short and thick as possible or rejecting ripple by incorporating inductance and capacitance).

10. Pin short and mistake fitting

Do not short-circuit between OUT pin and VCC pin, OUT pin and GND pin, or VCC pin and GND pin. When soldering the IC on circuit board, please be unusually cautious about the orientation and the position of the IC.

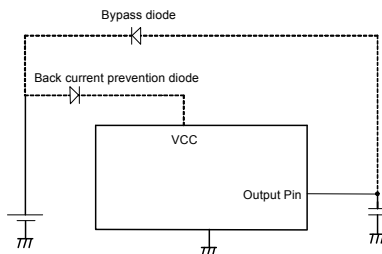

Fig.35

11. Application circuit

Although we can recommend the application circuits contained herein with a relatively high degree of confidence, we ask that you verify all characteristics and specifications of the circuit as well as performance under actual conditions. Please note that we cannot be held responsible for problems that may arise due to patent infringements or noncompliance with any and all applicable laws and regulations.

12. Operation

The IC will turn ON when the voltage at the STBY pin is greater than 2.0V and will switch OFF if under 0.3V. Therefore, do not input voltages between 0.3V and 2.0V. Malfunctions and/or physical damage may occur.

● Power Dissipation

TO252-S

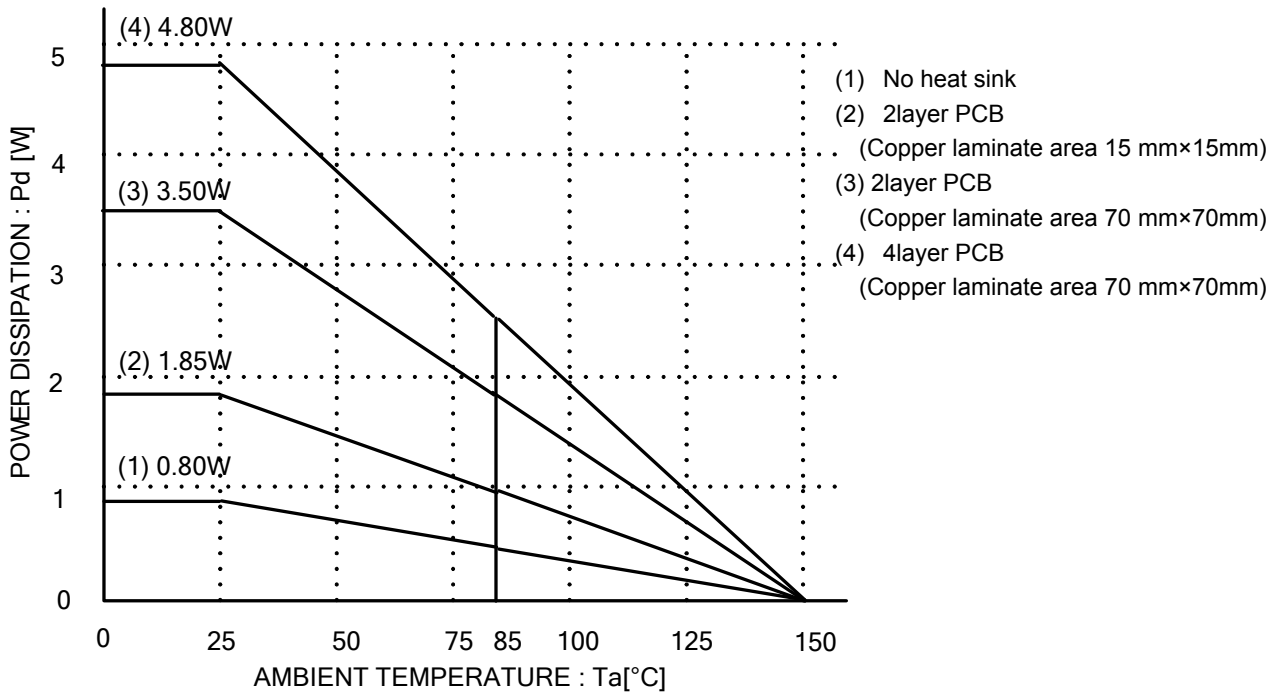

Fig.36

TO220

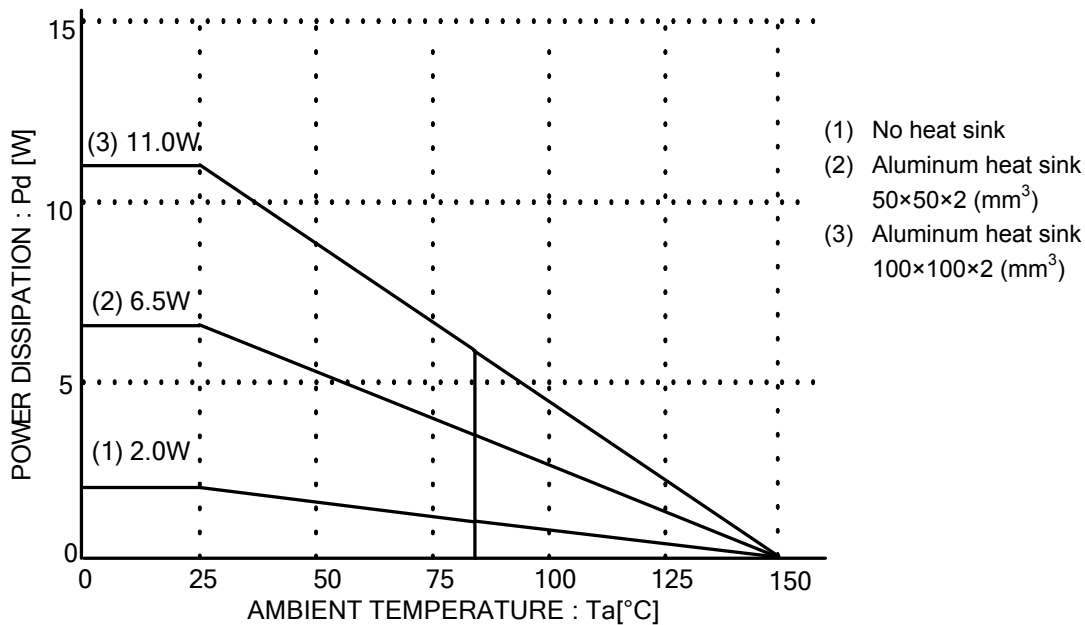
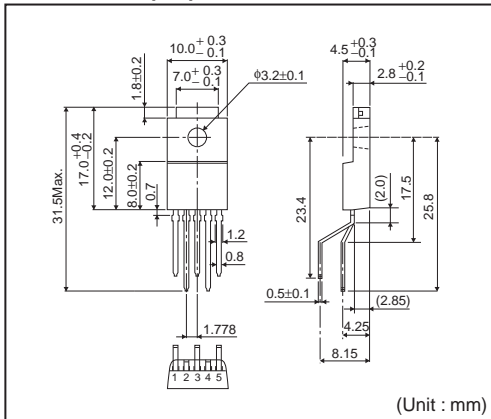

Fig.37



**TO220FP-5(V5)**



<Tape and Reel information>

Container	Tube
Quantity	500pcs
Direction of feed	Direction of products is fixed in a container tube

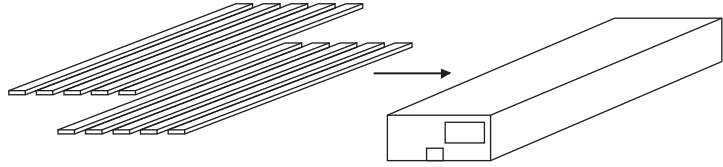

\*Order quantity needs to be multiple of the minimum quantity.

**TO220CP-V5**

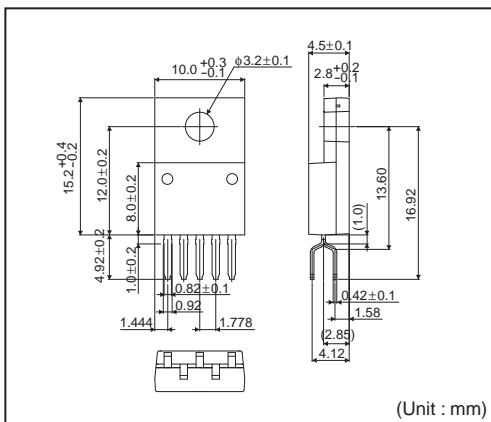

<Tape and Reel information>

Tape	Embossed carrier tape
Quantity	500pcs
Direction of feed	E2 ( The direction is the 1pin of product is at the lower left when you hold reel on the left hand and you pull out the tape on the right hand )

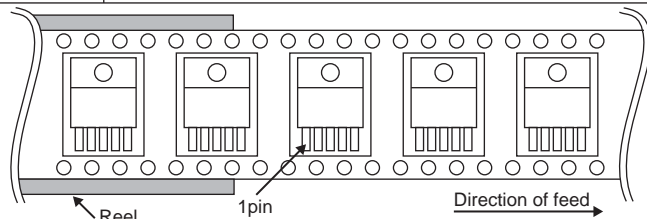

\*Order quantity needs to be multiple of the minimum quantity.



## Notes

No copying or reproduction of this document, in part or in whole, is permitted without the consent of ROHM Co.,Ltd.

The content specified herein is subject to change for improvement without notice.

The content specified herein is for the purpose of introducing ROHM's products (hereinafter "Products"). If you wish to use any such Product, please be sure to refer to the specifications, which can be obtained from ROHM upon request.

Examples of application circuits, circuit constants and any other information contained herein illustrate the standard usage and operations of the Products. The peripheral conditions must be taken into account when designing circuits for mass production.

Great care was taken in ensuring the accuracy of the information specified in this document. However, should you incur any damage arising from any inaccuracy or misprint of such information, ROHM shall bear no responsibility for such damage.

The technical information specified herein is intended only to show the typical functions of and examples of application circuits for the Products. ROHM does not grant you, explicitly or implicitly, any license to use or exercise intellectual property or other rights held by ROHM and other parties. ROHM shall bear no responsibility whatsoever for any dispute arising from the use of such technical information.

The Products specified in this document are intended to be used with general-use electronic equipment or devices (such as audio visual equipment, office-automation equipment, communication devices, electronic appliances and amusement devices).

The Products specified in this document are not designed to be radiation tolerant.

While ROHM always makes efforts to enhance the quality and reliability of its Products, a Product may fail or malfunction for a variety of reasons.

Please be sure to implement in your equipment using the Products safety measures to guard against the possibility of physical injury, fire or any other damage caused in the event of the failure of any Product, such as derating, redundancy, fire control and fail-safe designs. ROHM shall bear no responsibility whatsoever for your use of any Product outside of the prescribed scope or not in accordance with the instruction manual.

The Products are not designed or manufactured to be used with any equipment, device or system which requires an extremely high level of reliability the failure or malfunction of which may result in a direct threat to human life or create a risk of human injury (such as a medical instrument, transportation equipment, aerospace machinery, nuclear-reactor controller, fuel-controller or other safety device). ROHM shall bear no responsibility in any way for use of any of the Products for the above special purposes. If a Product is intended to be used for any such special purpose, please contact a ROHM sales representative before purchasing.

If you intend to export or ship overseas any Product or technology specified herein that may be controlled under the Foreign Exchange and the Foreign Trade Law, you will be required to obtain a license or permit under the Law.



Thank you for your accessing to ROHM product informations.  
More detail product informations and catalogs are available, please contact us.

## ROHM Customer Support System

<http://www.rohm.com/contact/>

Компания «Океан Электроники» предлагает заключение долгосрочных отношений при поставках импортных электронных компонентов на взаимовыгодных условиях!

Наши преимущества:

- Поставка оригинальных импортных электронных компонентов напрямую с производств Америки, Европы и Азии, а так же с крупнейших складов мира;
- Широкая линейка поставок активных и пассивных импортных электронных компонентов (более 30 млн. наименований);
- Поставка сложных, дефицитных, либо снятых с производства позиций;
- Оперативные сроки поставки под заказ (от 5 рабочих дней);
- Экспресс доставка в любую точку России;
- Помощь Конструкторского Отдела и консультации квалифицированных инженеров;
- Техническая поддержка проекта, помощь в подборе аналогов, поставка прототипов;
- Поставка электронных компонентов под контролем ВП;
- Система менеджмента качества сертифицирована по Международному стандарту ISO 9001;
- При необходимости вся продукция военного и аэрокосмического назначения проходит испытания и сертификацию в лаборатории (по согласованию с заказчиком);
- Поставка специализированных компонентов военного и аэрокосмического уровня качества (Xilinx, Altera, Analog Devices, Intersil, Interpoint, Microsemi, Actel, Aeroflex, Peregrine, VPT, Syfer, Eurofarad, Texas Instruments, MS Kennedy, Miteq, Cobham, E2V, MA-COM, Hittite, Mini-Circuits, General Dynamics и др.);

Компания «Океан Электроники» является официальным дистрибьютором и эксклюзивным представителем в России одного из крупнейших производителей разъемов военного и аэрокосмического назначения «JONHON», а так же официальным дистрибьютором и эксклюзивным представителем в России производителя высокотехнологичных и надежных решений для передачи СВЧ сигналов «FORSTAR».



## JONHON

«JONHON» (основан в 1970 г.)

Разъемы специального, военного и аэрокосмического назначения:

(Применяются в военной, авиационной, аэрокосмической, морской, железнодорожной, горно- и нефтедобывающей отраслях промышленности)

«FORSTAR» (основан в 1998 г.)

ВЧ соединители, коаксиальные кабели, кабельные сборки и микроволновые компоненты:

(Применяются в телекоммуникациях гражданского и специального назначения, в средствах связи, РЛС, а так же военной, авиационной и аэрокосмической отраслях промышленности).



Телефон: 8 (812) 309-75-97 (многоканальный)

Факс: 8 (812) 320-03-32

Электронная почта: [ocean@oceanchips.ru](mailto:ocean@oceanchips.ru)

Web: <http://oceanchips.ru/>

Адрес: 198099, г. Санкт-Петербург, ул. Калинина, д. 2, корп. 4, лит. А