

DATA SHEET

SURFACE-MOUNT CERAMIC EMI FILTER CAPACITORS

X2Y® Series
6.3 V TO 100 V

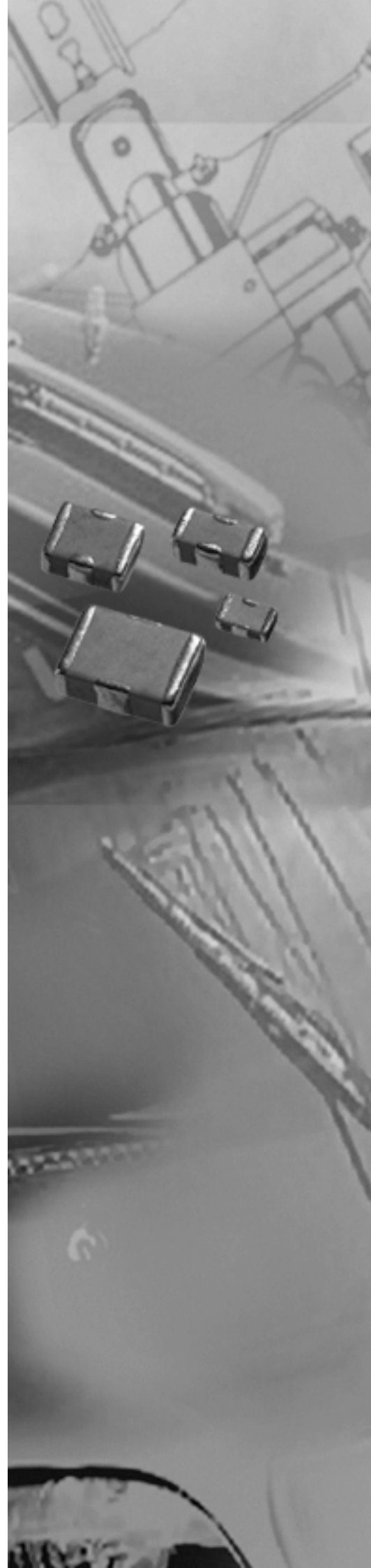

Surface-mount ceramic EMI filter capacitors

X2Y® Series

DESCRIPTION

X2Y® series is a breakthrough in the design of ceramic multilayer products for decoupling and filtering in an IPD (integrated passive device).

X2Y® products comprise two identical Y-capacitors and one X-capacitor, integrated into a 4 terminal device, which is available in standard MLCC sizes. Thanks to the unique multilayer construction the device provides noise cancellation within the device, reducing ESL from nanohenry to picohenry levels.

Using the unique balance between the Y-capacitors and the shielded multilayer structure the X2Y® products offer superior decoupling and filtering.

The X2Y® device performs as a broadband filter enabling better EMC compliance for electrical equipment in a wide range of applications.

FEATURES

- **Broadband Filtering and Decoupling:** X2Y® is effective up to 10 GHz and frequencies beyond
- **Ultra Low ESL:** Noise cancellation within X2Y® makes ESL reducing from nanohenry to picohenry levels
- **Bypass:** Unlike feedthrough capacitors, X2Y® is in bypass, so no DC current limitations
- **Matched Y-caps:** Two tightly matched line to ground capacitors in one device
- **Superior Balance:** Temperature and voltage variations balanced of two Y-caps
- **Aging Reliability:** Aging effects are equal on two Y-caps

BENEFITS

- **Fewer Component in Filtering:** One X2Y® can replace multiple inductors and/or capacitors
- **Superior Performance in Filtering:** One X2Y® can eliminate both differential and common mode noises
- **Fewer Component in Decoupling:** Up to 1:7 replacement of MLCC in power delivering system bypass networks
- **Superior Performance in Decoupling:** Large or small, X2Y® components exhibit ultra low ESL
- **Total Cost Savings:** Assembly cost savings through reduced component count and placement costs
- **Board Level Design Advantages:** Dramatically reduces via drills, which blocks routing

APPLICATIONS

- EMI filtering on DC motors
- Filtered connectors (airbag connectors, RJ-45 connectors)
- High speed data-line filtering
- Decoupling of supply-lines in high speed digital circuits
- Broadband filtering.
- Amplifier decoupling and EMI suppression.
- IC Decoupling, on-package, on-PCB.
- DC power line filtering.
- Data line filtering.
- EMI suppression for DC motors.
- Sensors
- Audio

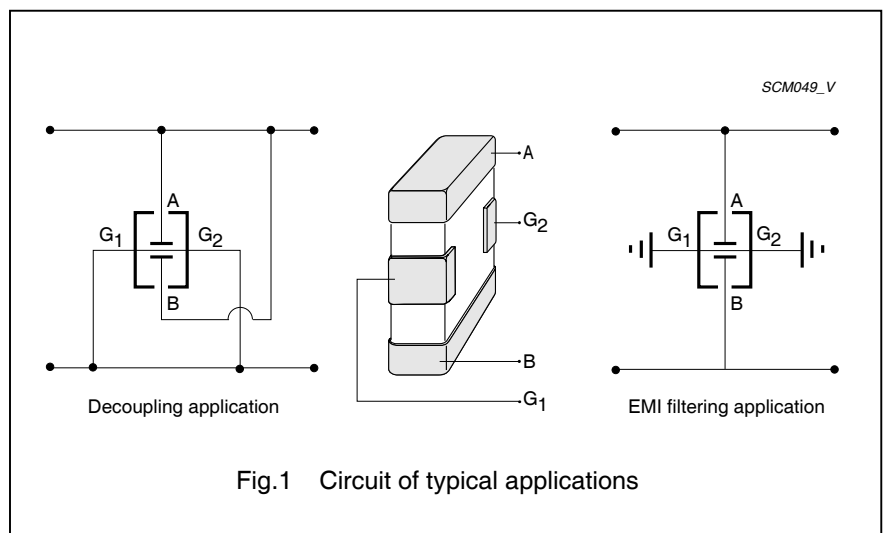

Surface-mount ceramic EMI filter capacitors

X2Y® Series

QUICK REFERENCE DATA

DESCRIPTION	VALUE
Materials	NPO / X7R / X5R
Rated voltage	
NPO	50 / 63 V
X7R	10 V, 16 V, 25 V, 50 / 63 V, 100 V (IEC)
X5R	6.3 V, 10V
Capacitance range (Y-capacitor)	
NPO 0805 series	22 pF, 47 pF
X7R 0603 series	1.0 nF to 100 nF
0805 series	4.7 nF to 180 nF
1206 series	15 nF to 820 nF
1210 series	47 nF to 1 µF
1410 series	390 nF
X5R 0603 series	220 nF to 470 nF
Tolerance on capacitance	±20% (M)
Test voltage (DC) for 1 minute	$2.5 \times U_r$
Sectional specifications	IEC 60384-10, second edition 1989-04; also based on CECC 32 100
Detailed specification	based on IEC 60384-10-1
Climatic category (IEC 60068)	X7R: 55 / 125 / 56

Surface-mount ceramic EMI filter capacitors

X2Y® Series

GENERAL SELECTION CHART

C (pF)	NPO	X7R					X5R
	0805	0603	0805	1206	1210	1410	0603
10							
22	50 V						
47							
100							
220							
330							
1,000		100 V					
1,500							
2,200							
4,700			100 V				
5,600		50 V / 63 V					
10,000							
15,000		25 V	50 V / 63 V	100 V			
18,000							
22,000			25 V				
39,000		16 V	16 V	50 V / 63 V	100 V		
47,000							
56,000							
100,000		10 V					
180,000			10 V	25 V	50 V / 63 V		
220,000							
270,000				16 V			10 V
330,000							
390,000					25 V	50 V	6.3 V
470,000							
560,000				10 V			
820,000					16 V		
1 000,000							

Surface-mount ceramic EMI filter capacitors

X2Y® Series

MECHANICAL DATA

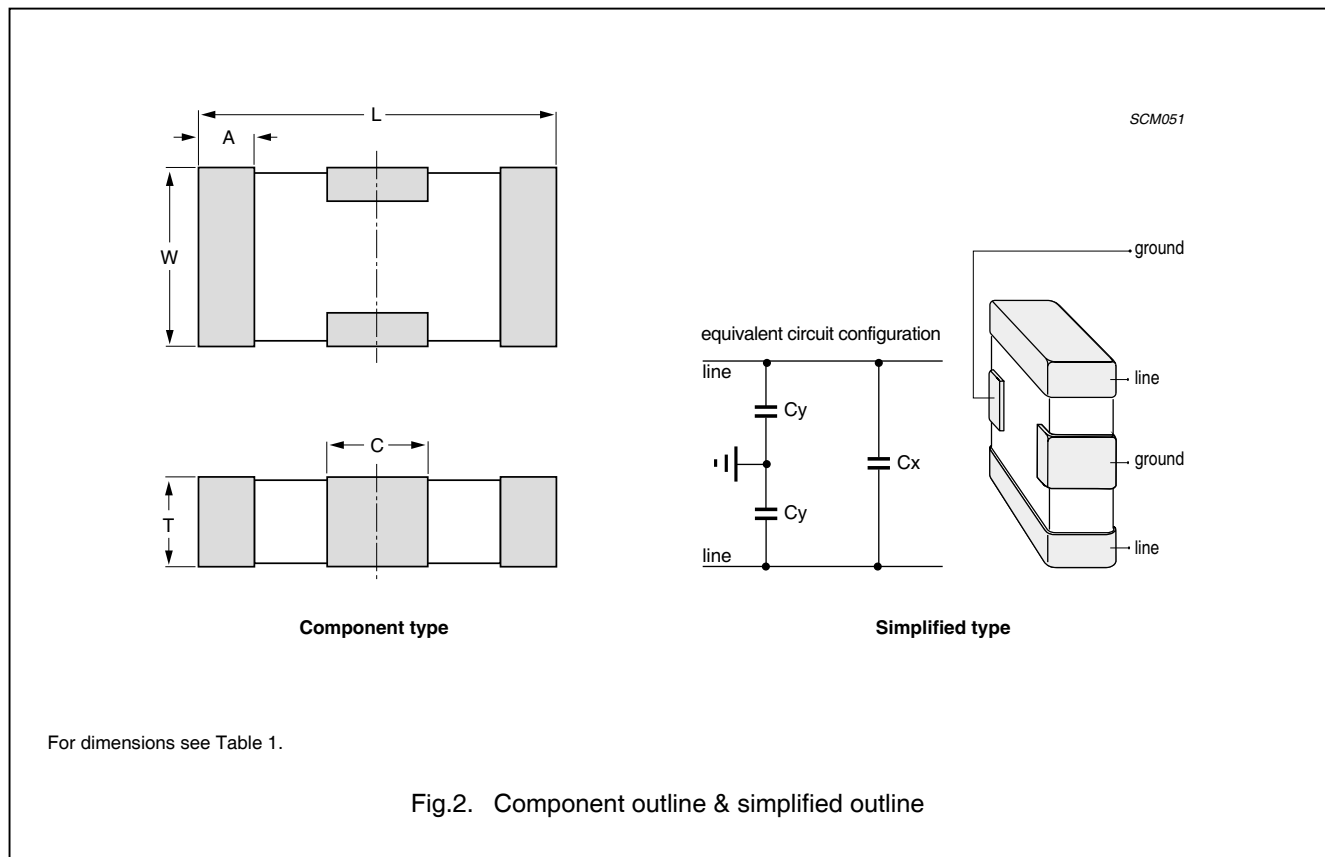

Physical dimensions

Table 1 Capacitor dimensions

CASE SIZE	L	W	T		A		C
			MIN.	MAX.	MIN.	MAX.	
Dimensions in millimetres							
0603	1.6 ±0.15	0.85 ±0.15	0.55	0.75	0.25	0.55	0.40 ±0.20
0805	2.0 ±0.15	1.25 ±0.15	0.75	0.95	0.25	0.55	0.70 ±0.20
1206	3.2 ±0.20	1.65 ±0.20	1.10	1.40	0.25	0.65	1.20 ±0.30
1210	3.2 ±0.20	2.5 ±0.20	1.10	1.70	0.25	0.65	1.20 ±0.30
1410	3.56 ±0.20	2.5 ±0.20	1.10	1.50	0.25	0.65	1.20 ±0.30
Dimensions in inches							
0603	0.063 ±0.006	0.032 ±0.006	0.022	0.030	0.010	0.022	0.016 ±0.008
0805	0.079 ±0.006	0.049 ±0.006	0.030	0.037	0.010	0.022	0.028 ±0.008
1206	0.126 ±0.008	0.065 ±0.008	0.043	0.055	0.010	0.026	0.047 ±0.012
1210	0.126 ±0.008	0.098 ±0.008	0.043	0.067	0.010	0.026	0.047 ±0.012
1410	0.140 ±0.008	0.098 ±0.008	0.043	0.059	0.010	0.026	0.047 ±0.012

Surface-mount ceramic EMI filter capacitors

X2Y® Series

ELECTRICAL CHARACTERISTICS FOR NPO

Class 1 capacitors; NPO dielectric; NiSn terminations

DESCRIPTION	VALUE
Rated voltage U_r (DC)	50 V
Capacitance range	22 pF, 47pF
Capacitance tolerance	±20%
Tan δ ; note 1	$\leq 10 \times 10^{-4}$
Insulation resistance after 1 minute at U_r (DC)	$R_{ins} > 10 \text{ G}\Omega$
Temperature Coefficient	$(0 \pm 30) \times 10^{-6} / \text{K}$

Note

1. Measured at 20 °C, 1 V and 1 MHz, using a four-gauge method.

ELECTRICAL CHARACTERISTICS FOR X7R / X5R

Class 2 capacitors; X7R / X5R dielectric; NiSn terminations

Unless otherwise stated all electrical values apply at an ambient temperature of 20 ± 1 °C, an atmospheric pressure of 86 to 106 kPa, and a relative humidity of 63 to 67%.

DESCRIPTION	VALUE
Rated voltage U_r (DC)	6.3 V, 10 V, 16 V, 25 V, 50 V/63 V and 100 V
Capacitance range	1.0 nF to 1 μ F
Tolerance on capacitance after 1,000 hours	±20%
Dissipation factor (D.F.); note 1	
6.3 V	7%
10 V	7%
16 V	7%
≥ 25 V	5%
Insulation resistance after 1 minute at U_r (DC)	$R_{ins} \times C > 500$ seconds or $R_{ins} > 10 \text{ G}\Omega$, whichever is less
Maximum capacitance change as a function of temperature	±15%
Operating temperature range:	
X5R	- 55 °C to +85 °C
X7R	- 55 °C to +125 °C
Aging	Typical 1% per time decade

Note

1. Measured at 20 °C, 1 V and 1 kHz, using a four-gauge method.

Surface-mount ceramic EMI filter capacitors

X2Y® Series

SELECTION CHART FOR X7R SIZES 0603, 0805, 1206, 1410 ⁽¹⁾

SIZE	Y-CAPACITOR		X-CAPACITOR		THICKNESS (mm)	CTC ORDERING CODE ⁽²⁾
	CAP. (nF)	VOLTAGE RATING (V)	CAP. (nF)	VOLTAGE RATING (V)		
0603	1.0	100	0.5	200	0.60	CX 0603 MR X7R 0BB 102
	1.5	100	0.75	200	0.60	CX 0603 MR X7R 0BB 152
	2.2	100	1.1	200	0.60	CX 0603 MR X7R 0BB 222
	4.7	100	2.4	200	0.60	CX 0603 MR X7R 0BB 472
	5.6	50 / 63	2.8	100	0.60	CX 0603 MR X7R 9BB 562
	10	50 / 63	5	100	0.60	CX 0603 MR X7R 9BB 103
	22	25	11	50	0.60	CX 0603 MR X7R 8BB 223
	47	16	24	25	0.60	CX 0603 MR X7R 7BB 473
	56	16	28	25	0.60	CX 0603 MR X7R 7BB 563
	100	10	50	16	0.60	CX 0603 MR X7R 6BB 104
0805	4.7	100	2.4	200	0.85	CX 0805 MR X7R 0BB 472
	10	100	5	200	0.85	CX 0805 MR X7R 0BB 103
	15	50 / 63	8	100	0.85	CX 0805 MR X7R 9BB 153
	18	50 / 63	9	100	0.85	CX 0805 MR X7R 9BB 183
	22	25	11	50	0.85	CX 0805 MR X7R 8BB 223
	39	25	20	50	0.85	CX 0805 MR X7R 8BB 393
	47	16	24	25	0.85	CX 0805 MR X7R 7BB 473
	100	16	50	25	0.85	CX 0805 MR X7R 7BB 104
	180	10	90	16	0.85	CX 0805 MR X7R 6BB 184
1206	22	100	11	200	1.20	CX 1206 MK X7R 0BB 223
	47	50 / 63	24	100	1.20	CX 1206 MK X7R 9BB 473
	100	50 / 63	50	100	1.20	CX 1206 MK X7R 9BB 104
	180	25	90	50	1.20	CX 1206 MK X7R 8BB 184
	220	16	110	25	1.20	CX 1206 MK X7R 7BB 224
	390	16	195	25	1.20	CX 1206 MK X7R 7BB 394
	470	10	235	20	1.20	CX 1206 MK X7R 6BB 474
	820	10	410	20	1.20	CX 1206 MK X7R 6BB 824
1210	47	100	24	200	1.20	CX 1210 MK X7R 0BB 473
	100	50/63	50	100	1.20	CX 1210 MK X7R 9BB 104
	220	50/63	110	100	1.60	CX 1210 MK X7R 9BB 224
	470	25	235	50	1.60	CX 1210 MK X7R 8BB 474
	560	25	280	50	1.60	CX 1210 MK X7R 8BB 564
	820	16	410	25	1.60	CX 1210 MK X7R 7BB 824
	1000	16	500	25	1.60	CX 1210 MK X7R 7BB 105
1410	390	50	195	100	1.30	CX 1410 MK X7R 9BB 394

Surface-mount ceramic EMI filter capacitors

X2Y® Series

SELECTION CHART FOR X5R SIZES 0603 ⁽¹⁾

SIZE	Y-CAPACITOR		X-CAPACITOR		THICKNESS (mm)	CTC ORDERING CODE ⁽²⁾
	CAP. (nF)	VOLTAGE RATING (V)	CAP. (nF)	VOLTAGE RATING (V)		
0603	220	10	110	20	0.60	CX 0603 MR X5R 6BB 224
	330	10	165	20	0.60	CX 0603 MR X5R 6BB 334
	470	6.3	235	12	0.60	CX 0603 MR X5R 5BB 474

Notes

- Other values are available on request.
- Ordering codes for preferred versions (20% tolerance, 180 mm reel). For other packing and tolerance see section "Ordering Code Information".

SELECTION CHART FOR NPO SIZES 0805 ⁽¹⁾

SIZE	Y-CAPACITOR		X-CAPACITOR		THICKNESS (mm)	CTC ORDERING CODE ⁽²⁾
	CAP. (nF)	VOLTAGE RATING (V)	CAP. (nF)	VOLTAGE RATING (V)		
0805	0.022	50	0.011	100	0.85	CX 0805 MR NPO 9BB 220
	0.047	50	0.023	100	0.85	CX 0805 MR NPO 9BB 470

Notes

- Other values are available on request.
- Ordering codes for preferred versions (20% tolerance, 180 mm reel). For other packing and tolerance see section "Ordering Code Information".

THICKNESS CLASSIFICATION AND PACKING QUANTITIES FOR X7R

THICKNESS CLASSIFICATION (mm)	QUANTITY PER REEL	
	8 mm TAPE WIDTH	
	Ø180 mm; 7"	
	PAPER	BLISTER
0.6 ±0.1	4,000	–
0.85 ±0.1	4,000	–
1.2 ±0.15	–	2,500
1.6 ±0.15	–	2,500
1.9 ±0.2	–	2,500

Surface-mount ceramic EMI filter capacitors

X2Y® Series

ORDERING INFORMATION

Components may be ordered by using either a Yageo part number or Phycomp's unique 12NC.

Ordering code: Yageo part number

Example: CX0805MRX7R8BB223

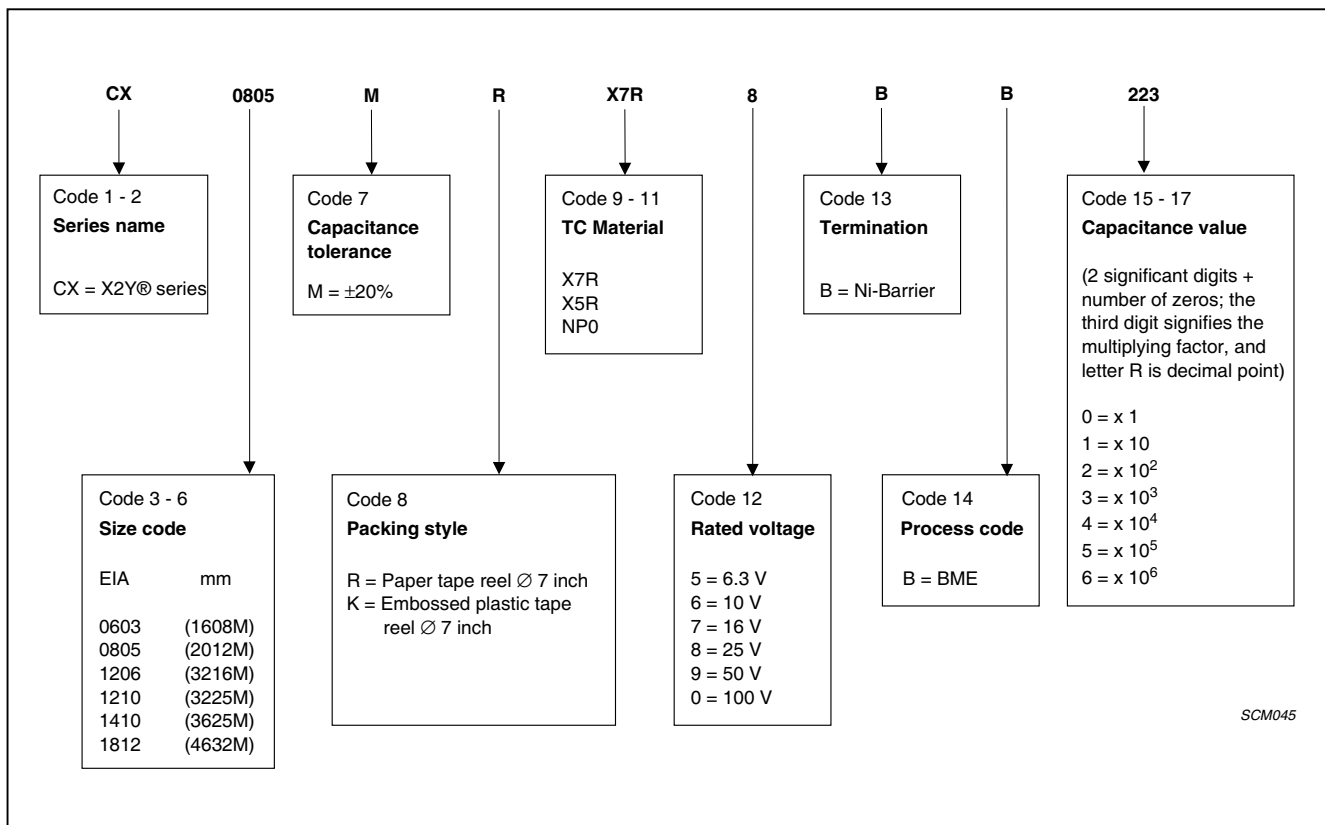

Surface-mount ceramic EMI filter capacitors

X2Y® Series

Table 2 Conversion table for Yageo part number

TC	SIZE	CAP. VALUE	CAP. TOLERANCE	RATED VOLTAGE (V)	CTC ORDERING CODE	QUANTITY PER REEL
		Y-CAP	Y-CAP	Y-CAP		
X7R	0603	1.0 nF	±20%	100	CX 0603 MR X7R 0BB 102	4,000
X7R	0603	1.5 nF	±20%	100	CX 0603 MR X7R 0BB 152	4,000
X7R	0603	2.2 nF	±20%	100	CX 0603 MR X7R 0BB 222	4,000
X7R	0603	4.7 nF	±20%	100	CX 0603 MR X7R 0BB 472	4,000
X7R	0603	5.6 nF	±20%	50 / 63	CX 0603 MR X7R 9BB 562	4,000
X7R	0603	10 nF	±20%	50 / 63	CX 0603 MR X7R 9BB 103	4,000
X7R	0603	22 nF	±20%	25	CX 0603 MR X7R 8BB 223	4,000
X7R	0603	47 nF	±20%	16	CX 0603 MR X7R 7BB 473	4,000
X7R	0603	56 nF	±20%	16	CX 0603 MR X7R 7BB 563	4,000
X7R	0603	100 nF	±20%	10	CX 0603 MR X7R 6BB 104	4,000
X7R	0805	4.7 nF	±20%	100	CX 0805 MR X7R 0BB 472	4,000
X7R	0805	10 nF	±20%	100	CX 0805 MR X7R 0BB 103	4,000
X7R	0805	15 nF	±20%	50 / 63	CX 0805 MR X7R 9BB 153	4,000
X7R	0805	18 nF	±20%	50 / 63	CX 0805 MR X7R 9BB 183	4,000
X7R	0805	22 nF	±20%	25	CX 0805 MR X7R 8BB 223	4,000
X7R	0805	39 nF	±20%	25	CX 0805 MR X7R 8BB 393	4,000
X7R	0805	47 nF	±20%	16	CX 0805 MR X7R 7BB 473	4,000
X7R	0805	100 nF	±20%	16	CX 0805 MR X7R 7BB 104	4,000
X7R	0805	180 nF	±20%	10	CX 0805 MR X7R 6BB 184	4,000
X7R	1206	22 nF	±20%	100	CX 1206 MK X7R 0BB 223	2,500
X7R	1206	47 nF	±20%	50 / 63	CX 1206 MK X7R 9BB 473	2,500
X7R	1206	100 nF	±20%	50 / 63	CX 1206 MK X7R 9BB 104	2,500
X7R	1206	180 nF	±20%	25	CX 1206 MK X7R 8BB 184	2,500
X7R	1206	220 nF	±20%	16	CX 1206 MK X7R 7BB 224	2,500
X7R	1206	390 nF	±20%	16	CX 1206 MK X7R 7BB 394	2,500
X7R	1206	470 nF	±20%	10	CX 1206 MK X7R 6BB 474	2,500
X7R	1206	820 nF	±20%	10	CX 1206 MK X7R 6BB 824	2,500
X7R	1210	47 nF	±20%	100	CX 1210 MK X7R 0BB 473	2,500
X7R	1210	100 nF	±20%	50 / 63	CX 1210 MK X7R 9BB 104	2,500
X7R	1210	220 nF	±20%	50 / 63	CX 1210 MK X7R 9BB 224	2,500
X7R	1210	470 nF	±20%	25	CX 1210 MK X7R 8BB 474	2,500
X7R	1210	560 nF	±20%	25	CX 1210 MK X7R 8BB 564	2,500
X7R	1210	820 nF	±20%	16	CX 1210 MK X7R 7BB 824	2,500
X7R	1210	1 µF	±20%	16	CX 1210 MK X7R 7BB 105	2,500
X7R	1410	390 nF	±20%	50	CX 0603 MR X5R 9BB 394	2,500

Surface-mount ceramic EMI filter capacitors

X2Y® Series

Table 2 Conversion table for Yageo part number

TC	SIZE	CAP. VALUE	CAP. TOLERANCE	RATED VOLTAGE (V)	CTC ORDERING CODE	QUANTITY PER REEL
		Y-CAP	Y-CAP	Y-CAP		
X5R	0603	220 nF	±20%	10	CX 0603 MR X5R 6BB 224	4,000
X5R	0603	330 nF	±20%	10	CX 0603 MR X5R 6BB 334	4,000
X5R	0603	470 nF	±20%	6.3	CX 0603 MR X5R 5BB 474	4,000
NPO	0805	22 pF	±20%	50	CX 0805 MR NPO 9BB 220	4,000
NPO	0805	47 pF	±20%	50	CX 0805 MR NPO 9BB 470	4,000

RECOMMENDED DIMENSIONS OF SOLDER LANDS

Table 3 Reflow soldering

CASE SIZE (EIA)	Footprint dimensions (mm)					Placement Accuracy (mm)
	A	B	C	D	E	
0603	2.30	0.76	0.64	0.51	1.52	±0.20
0805	3.05	1.27	0.89	0.56	2.03	±0.20
1206	4.06	1.65	1.00	1.02	3.05	±0.25
1210	4.57	2.55	1.00	1.14	4.06	±0.25
1410	4.57	2.55	1.00	1.14	4.06	±0.25

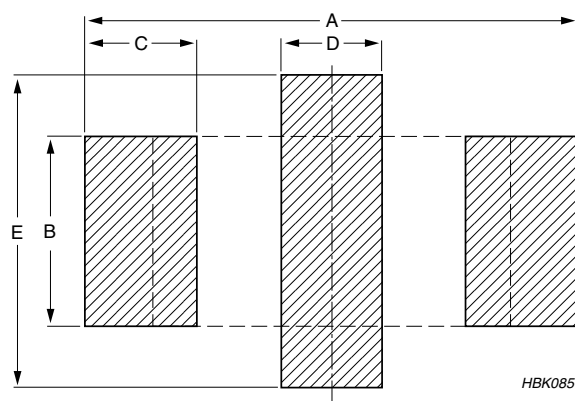
Fig.3 Recommended dimensions of solder lands

Surface-mount ceramic EMI filter capacitors

X2Y® Series

MEASUREMENT SETUP

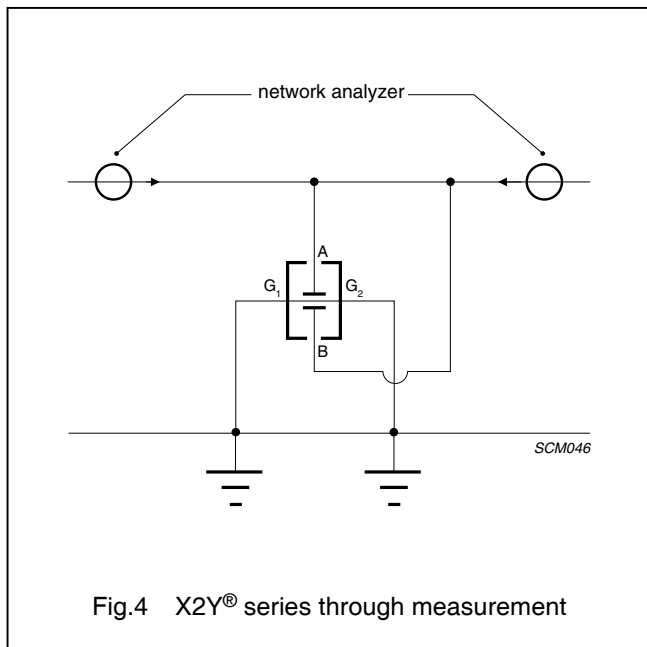

- X2Y® are soldered on a printed circuit board
- PCB: FR-4 substrate, with 50 Ω microstrip line
- Network Analyzer: Agilent E5071b
- Calibration: full 2-port calibration with 85033E kit

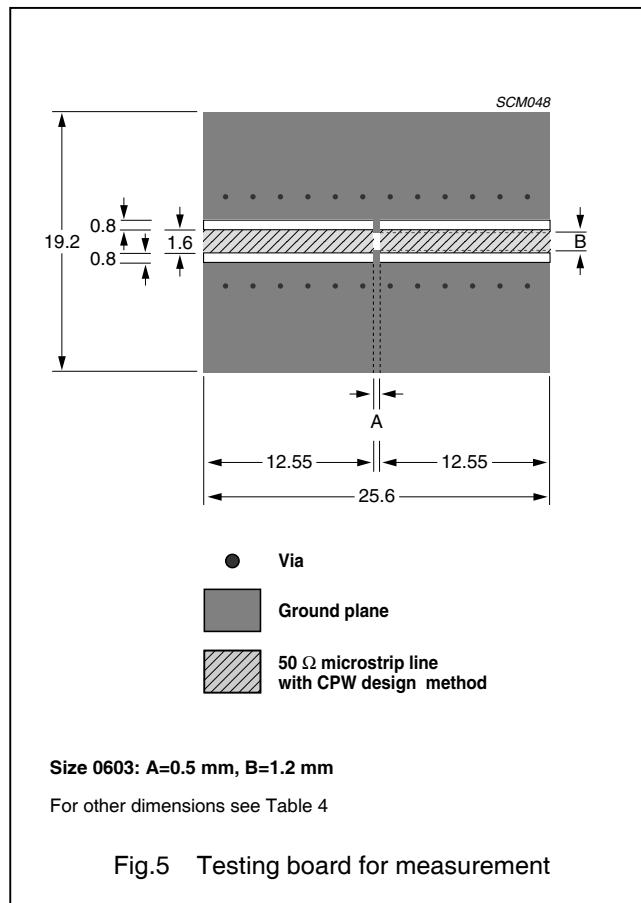

Table 4 Recommended dimensions of measurement

CASE SIZE	A (mm)	B (mm)
0603	0.5 ±0.10	1.2 ±0.10
0805	0.8 ±0.10	1.6 ±0.10
1206	1.2 ±0.10	2.8 ±0.15
1210	2.1 ±0.15	2.8 ±0.15
1410	2.1 ±0.15	3.1 ±0.15

Surface-mount ceramic EMI filter capacitors

X2Y® Series

TESTS AND REQUIREMENTS

Table 5 Test procedures and requirements

TEST METHOD	TEST	PROCEDURE	REQUIREMENTS
IEC60384-21/22			
4.3	mounting	The capacitors may be mounted on printed-circuit boards or ceramic substrates	no visible damage
4.4	visual inspection and dimension check	any applicable method using $\times 10$ magnification	in accordance with specification
4.5.1	capacitance	NP0: $f = 1 \text{ MHz}$ for $C \leq 1 \text{ nF}$, measuring at voltage $1 V_{\text{rms}}$ at $20 \text{ }^\circ\text{C}$; $f = 1 \text{ KHz}$ for $C > 1 \text{ nF}$, measuring at voltage $1 V_{\text{rms}}$ at $20 \text{ }^\circ\text{C}$ X5R/X7R/Y5V: $f = 1 \text{ KHz}$ for $C \leq 10 \text{ } \mu\text{F}$, measuring at voltage $1 V_{\text{rms}}$ at $20 \text{ }^\circ\text{C}$	within specified tolerance
4.5.2	Dissipation factor (D.F.)	NP0: $f = 1 \text{ MHz}$ for $C \leq 1 \text{ nF}$, measuring at voltage $1 V_{\text{rms}}$ at $20 \text{ }^\circ\text{C}$; $f = 1 \text{ KHz}$ for $C > 1 \text{ nF}$, measuring at voltage $1 V_{\text{rms}}$ at $20 \text{ }^\circ\text{C}$ X5R/X7R/Y5V: $f = 1 \text{ KHz}$ for $C \leq 10 \text{ } \mu\text{F}$, measuring at voltage $1 V_{\text{rms}}$ at $20 \text{ }^\circ\text{C}$	in accordance with specifications
4.5.3	insulation resistance	at U_r (DC) for 1 minute	in accordance with specification
4.5.4.2	voltage proof	Test voltage (DC) applied for 1 minute $U_r \leq 100 \text{ V}$: $2.5 \times U_r$ applied to NP0/X5R/X7R/Y5V series $100 \text{ V} < U_r \leq 200 \text{ V}$: $1.5 \times U_r + 100 \text{ V}$ applied to NP0/X7R series $200 \text{ V} < U_r \leq 500 \text{ V}$: $1.3 \times U_r + 100 \text{ V}$ applied to NP0/X7R series $U_r > 500 \text{ V}$: $1.3 \times U_r$ applied to NP0/X7R series I : 7.5 mA	no breakdown or flashover

Surface-mount ceramic EMI filter capacitors

X2Y[®] Series

Table 5 Test procedures and requirements (continued)

TEST METHOD	TEST	PROCEDURE	REQUIREMENTS
IEC 60384-21/22			
4.6	temperature characteristic	Between minimum and maximum temperature	NP0: $\Delta C/C: \pm 30 \text{ ppm}/^\circ\text{C}$ X5R/X7R: $\Delta C/C: \pm 15\%$ Y5V: $\Delta C/C: +22\% \sim -82\%$
4.15	adhesion	A force applied for 10 seconds to the line joining the terminations and in a plane parallel to the substrate for size ≥ 0603 : a force of 5 N applied for size 0402: a force of 2.5 N applied for size 0201: a force of 1 N applied	no visible damage
4.8	bond strength of plating on end face	Mounting in accordance with IEC 60384-22 paragraph 4.3	no visible damage
		Conditions: bending 1 mm at a rate of 1 mm/s, radius jig 340 mm	NP0: $ \Delta C/C : \leq 1\%$ or 0.5 pF whichever is greater X5R/X7R/Y5V: $ \Delta C/C : \leq 10\%$
4.9	Resistance to soldering heat	Precondition: $150 \pm 0/-10^\circ\text{C}$ for 1 hour, then keep for 24 ± 1 hours at room temperature Preheating: for size ≤ 1206 : 120 to 150°C for 1 minute Preheating: for size >1206 : 100 to 120°C for 1 minute and 170 to 200°C for 1 minute Solder bath temperature: $260 \pm 5^\circ\text{C}$ Dipping time: 10 ± 0.5 seconds Recovery time: 24 ± 2 hours	The termination shall be well tinned NP0: $ \Delta C/C : \leq 0.5\%$ or 0.5 pF whichever is greater X5R/X7R: $ \Delta C/C : \leq 10\%$ Y5V: $ \Delta C/C : \leq 20\%$ D.F.: within initial specified value R_{ins} : within initial specified value
4.10	Solderability	Unmounted chips completely immersed in a solder bath at $235 \pm 5^\circ\text{C}$ Dipping time: 2 ± 0.5 seconds Depth of immersion: 10 mm	The termination shall be well tinned

Surface-mount ceramic EMI filter capacitors

X2Y® Series

Table 5 Test procedures and requirements (continued)

TEST METHOD	TEST	PROCEDURE	REQUIREMENTS
IEC 60384-21/22			
4.11	Rapid change of temperature	<p>Preconditioning; 150 +0/-10 °C for 1 hour, then keep for 24 ±1 hours at room temperature</p> <p>5 cycles with following detail: 30 minutes at lower category temperature; 30 minutes at upper category temperature</p> <p>Recovery time 24 ±2 hours</p>	<p>No visual damage</p> <p>NP0: $\Delta C/C_i \leq 1\%$ or 1 pF whichever is greater</p> <p>X5R/X7R: $\Delta C/C_i \leq 15\%$</p> <p>Y5V: $\Delta C/C_i \leq 20\%$</p> <p>D.F.: within initial specified value</p> <p>R_{ins}: within initial specified value</p>
4.13	Damp heat, with U_r load	<p>Initial measurements; after 150 +0/-10 °C for 1 hour, then keep for 24 ±1 hours at room temperature</p> <p>Duration and conditions: 500 ±12 hours at 40 ±2 °C; 90 to 95% RH; U_r applied</p> <p>Final measurement: perform a heat treatment at 150 +0/-10 °C for 1 hour, final measurements shall be carried out 24 ±1 hours after recovery at room temperature without load</p>	<p>NP0: $\Delta C/C_i \leq 2\%$ or 1 pF whichever is greater</p> <p>X5R/X7R: $\Delta C/C_i \leq 20\%$</p> <p>Y5V: $\Delta C/C_i \leq 30\%$</p> <p>NP0/X5R/X7R/Y5V: D.F.: 2 × initial value max.</p> <p>NP0: $R_{ins} \geq 2,500 \text{ M}\Omega$ or $R_{ins} \times C_r \geq 25$ seconds, whichever is less</p> <p>X5R/X7R/Y5V: $R_{ins} \geq 500 \text{ M}\Omega$ or $R_{ins} \times C_r \geq 25$ seconds, whichever is less</p>
4.14	Endurance	<p>Preconditioning;</p> <p>Initial measurements; after 150 +0/-10 °C for 1 hour, then keep for 24 ±1 hours at room temperature</p> <p>Duration and conditions: 1,000 ±12 hours at upper category temperature with $1.5 \times U_r$ voltage applied</p> <p>Final measurement: perform a heat treatment at 150 +0/-10 °C for 1 hour, final measurements shall be carried out 24 ±1 hours after recovery at room temperature without load</p>	<p>NP0: $\Delta C/C_i \leq 2\%$ or 1 pF whichever is greater</p> <p>X5R/X7R: $\Delta C/C_i \leq 20\%$</p> <p>Y5V: $\Delta C/C_i \leq 30\%$</p> <p>NP0/X5R/X7R/Y5V: D.F.: 2 × initial value max.</p> <p>NP0: $R_{ins} \geq 4,000 \text{ M}\Omega$ or $R_{ins} \times C_r \geq 40$ seconds, whichever is less</p> <p>X5R/X7R/Y5V: $R_{ins} \geq 1,000 \text{ M}\Omega$ or $R_{ins} \times C_r \geq 50$ seconds, whichever is less</p>

Surface-mount ceramic EMI filter capacitors

X2Y® Series

REVISION HISTORY

Revision	Date	Change Notification	Description
Rev.5	2001 Sep 25	-	- Published on web
Rev.6	2002 Jul 10	-	- Product range extended in all materials and sizes; - Insertion loss measurements added.
Rev.7	2003 Apr 02	-	- Updated company logo
Rev.8	2003 Jul 23	-	- Cover page revised
Rev.9	2003 Sep 09	-	- Cover page corrected
Rev.10	2004 Apr 21	-	- Product range updated - NP0, Y5V and size 1812 removed.
Rev.11	2006 Nov 21	-	- Size 1410 extended - Product applications, features and benefits update - Measurement setup added - Updated tests and requirements
Rev.12	2006 Dec 22	-	- 12 NC revised
Rev.13	2008 Nov 10	-	- Product range extended in materials of NP0 and X5R

Компания «Океан Электроники» предлагает заключение долгосрочных отношений при поставках импортных электронных компонентов на взаимовыгодных условиях!

Наши преимущества:

- Поставка оригинальных импортных электронных компонентов напрямую с производств Америки, Европы и Азии, а так же с крупнейших складов мира;
- Широкая линейка поставок активных и пассивных импортных электронных компонентов (более 30 млн. наименований);
- Поставка сложных, дефицитных, либо снятых с производства позиций;
- Оперативные сроки поставки под заказ (от 5 рабочих дней);
- Экспресс доставка в любую точку России;
- Помощь Конструкторского Отдела и консультации квалифицированных инженеров;
- Техническая поддержка проекта, помощь в подборе аналогов, поставка прототипов;
- Поставка электронных компонентов под контролем ВП;
- Система менеджмента качества сертифицирована по Международному стандарту ISO 9001;
- При необходимости вся продукция военного и аэрокосмического назначения проходит испытания и сертификацию в лаборатории (по согласованию с заказчиком);
- Поставка специализированных компонентов военного и аэрокосмического уровня качества (Xilinx, Altera, Analog Devices, Intersil, Interpoint, Microsemi, Actel, Aeroflex, Peregrine, VPT, Syfer, Eurofarad, Texas Instruments, MS Kennedy, Miteq, Cobham, E2V, MA-COM, Hittite, Mini-Circuits, General Dynamics и др.);

Компания «Океан Электроники» является официальным дистрибьютором и эксклюзивным представителем в России одного из крупнейших производителей разъемов военного и аэрокосмического назначения «JONHON», а так же официальным дистрибьютором и эксклюзивным представителем в России производителя высокотехнологичных и надежных решений для передачи СВЧ сигналов «FORSTAR».



JONHON

«JONHON» (основан в 1970 г.)

Разъемы специального, военного и аэрокосмического назначения:

(Применяются в военной, авиационной, аэрокосмической, морской, железнодорожной, горно- и нефтедобывающей отраслях промышленности)

«FORSTAR» (основан в 1998 г.)

ВЧ соединители, коаксиальные кабели, кабельные сборки и микроволновые компоненты:

(Применяются в телекоммуникациях гражданского и специального назначения, в средствах связи, РЛС, а так же военной, авиационной и аэрокосмической отраслях промышленности).



Телефон: 8 (812) 309-75-97 (многоканальный)

Факс: 8 (812) 320-03-32

Электронная почта: ocean@oceanchips.ru

Web: <http://oceanchips.ru/>

Адрес: 198099, г. Санкт-Петербург, ул. Калинина, д. 2, корп. 4, лит. А