

CMOS LDO Regulators for Portable Equipments

1ch 150mA CMOS LDO Regulators

BH□□RB1WGUT series

No.11020ECT03

●Description

The BH□□RB1WGUT series is a line of 150 mA output CMOS regulators that deliver a highly stable precision ($\pm 1\%$) output voltage. Proprietary ROHM technology enables a small load regulation of 2 mV and a dropout voltage of 100 mV.

At just 1.0 mm \times 1.04 mm, the new VCSP60N1 package is extremely compact, and the IC's enhanced protection circuits contribute to improved end products characteristics.

●Features

- 1) High accuracy output voltage: $\pm 1\%$
- 2) Dropout voltage: 100 mV (at 100 mA)
- 3) Stable with ceramic capacitors
- 4) Low bias current: 34 μ A
- 5) High ripple rejection ratio: 63 dB (Typ., 1 kHz)
- 6) Output voltage on/off control
- 7) Built-in overcurrent and thermal shutdown circuits
- 8) VCSP60N1 WL-CSP package : (1.0 \times 1.04 \times 0.6mm)

●Applications

Battery-driven portable devices, etc.

●Product line
■150 mA BH□□RB1WGUT Series

Product name	1.5	1.8	2.5	2.8	2.9	3.0	3.1	3.3	Package
BH□□RB1WGUT	√	√	√	√	√	√	√	√	VCSP60N1

Model name: BH□□RB1W□
 a b

Symbol	Description			
a	Output voltage specification			
	□□	Output voltage (V)	□□	Output voltage (V)
	15	1.5 V (Typ.)	29	2.9 V (Typ.)
	18	1.8 V (Typ.)	30	3.0 V (Typ.)
	25	2.5 V (Typ.)	31	3.1 V (Typ.)
	28	2.8 V (Typ.)	33	3.3 V (Typ.)
b	Package GUT: VCSP60N1			

● Absolute maximum ratings

Parameter	Symbol	Ratings	Unit
Applied supply voltage	VMAX	-0.3 to +6.5	V
Power dissipation	Pd	530 ^{*1}	mW
Operating temperature range	Topr	-40 to +85	°C
Storage temperature range	Tstg	-55 to +125	°C

*1: Reduce by 5.3 mW/°C over 25°C, when mounted on a glass epoxy PCB (7 mm × 7 mm × 0.8 mm).

● Recommended operating ranges (not to exceed Pd)

Parameter	Symbol	Ratings	Unit
Power supply voltage	VIN	2.5 to 5.5	V
Output current	IOUT	0 to 150	mA

● Recommended operating conditions

Parameter	Symbol	Ratings			Unit	Conditions
		Min.	Typ.	Max.		
Input capacitor	CIN	0.7 ^{*2}	1.0	—	μF	The use of ceramic capacitors is recommended.
Output capacitor	Co	0.7 ^{*2}	1.0	—	μF	The use of ceramic capacitors is recommended.

*2: Make sure that the output capacitor value is not kept lower than this specified level across a variety of temperature, DC bias characteristic. And also make sure that the capacitor value cannot change as time progresses.

● Electrical characteristics

(Unless otherwise specified, Ta = 25°C, VIN = VOUT + 1.0 V^{*5}, STBY = 1.5 V, CIN = 1 μF, Co = 1 μF)

Parameter	Symbol	Limits			Unit	Conditions	
		Min.	Typ.	Max.			
Output voltage 1	VOUT1	VOUT × 0.99	VOUT	VOUT × 1.01	V	IOUT = 1 mA, Ta = 25°C, BH25RB1WGUT or higher	
		VOUT - 25 mV		VOUT + 25 mV		IOUT = 1 mA, Ta = 25°C, BH15, 18RB1WGUT	
Output voltage 2	VOUT2	VOUT × 0.97	VOUT	VOUT × 1.03	V	IOUT = 1 mA Ta = -40°C to 85°C ^{*3}	
Circuit current	IGND	—	34	72	μA	IOUT = 0 mA Ta = -40°C to 85°C ^{*3}	
Circuit current (STBY)	ICCST	—	—	1.0	μA	STBY = 0 V	
Ripple rejection ratio	RR	—	63	—	dB	VRR = -20 dBV, fRR = 1 kHz, IOUT = 10 mA	
Dropout voltage	VSAT	—	100	150	mV	VIN = 0.98 × VOUT, IOUT = 100 mA (Excluding BH15, 18RB1WGUT)	
Line regulation	VDLI	—	2	20	mV	IOUT = 10 mA VIN = VOUT + 0.5 V to 5.5 V ^{*4}	
Load regulation	VDLO	—	2	30	mV	IOUT = 1 mA to 100 mA	
Overcurrent protection limit current	ILMAX	—	300	—	mA	Vo = VOUT × 0.98	
Short current	ISHORT	—	40	—	mA	Vo = 0 V	
STBY pin current	ISTBY	0.5	1.3	3.6	μA	Ta = -40°C to 85°C ^{*3}	
STBY control voltage	ON	VSTBH	1.2	—	VIN	V	Ta = -40°C to 85°C ^{*3}
	OFF	VSTBL	-0.2	—	0.2	V	Ta = -40°C to 85°C ^{*3}

* This IC is not designed to be radiation-resistant.

*3: These specifications are guaranteed by design.

*4: For BH15, 18RB1WGUT, VIN = 3.0 V to 5.5 V.

*5: For BH15, 18RB1WGUT, VIN = 3.5 V.

● Typical characteristics

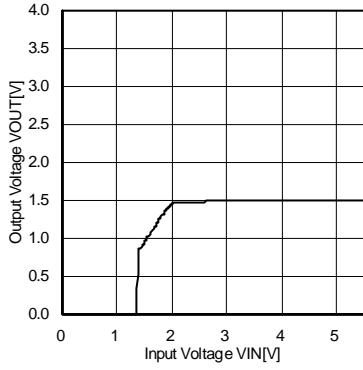

Fig. 1 Output Voltage vs Input Voltage (BH15RB1WGUT)

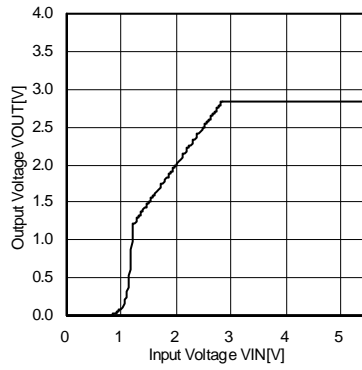

Fig. 2 Output Voltage vs Input Voltage (BH28RB1WGUT)

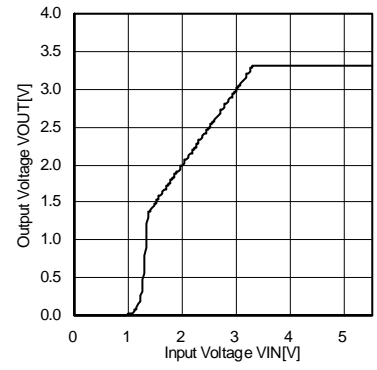

Fig. 3 Output Voltage vs Input Voltage (BH33RB1WGUT)

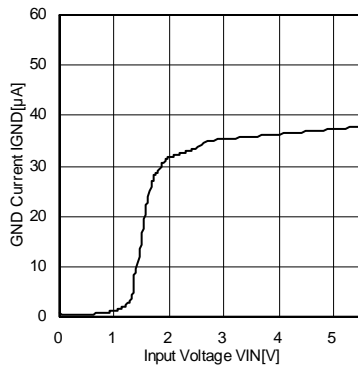

Fig. 4 GND Current vs Input Voltage (BH15RB1WGUT)

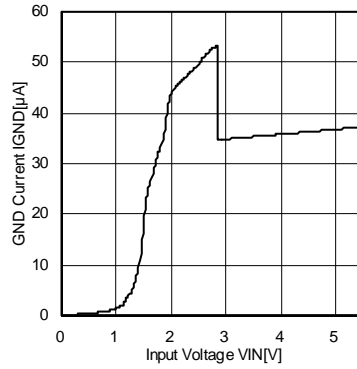

Fig. 5 GND Current vs Input Voltage (BH28RB1WGUT)

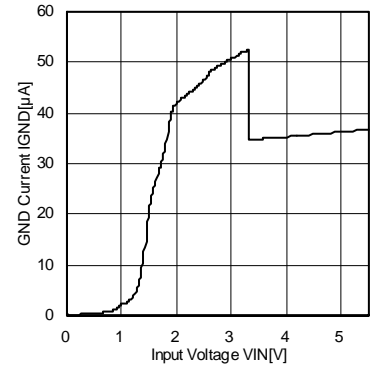

Fig. 6 GND Current vs Input Voltage (BH33RB1WGUT)

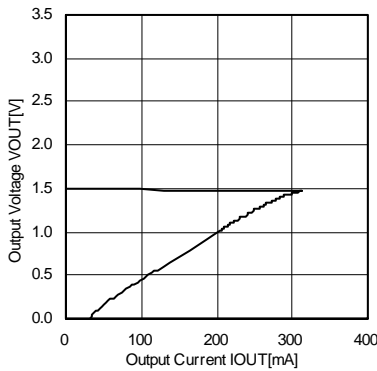

Fig. 7 Output Voltage vs Output Current (BH15RB1WGUT)

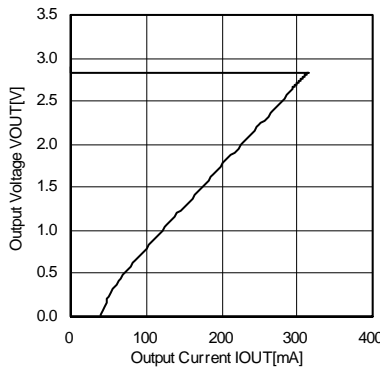

Fig. 8 Output Voltage vs Output Current (BH28RB1WGUT)

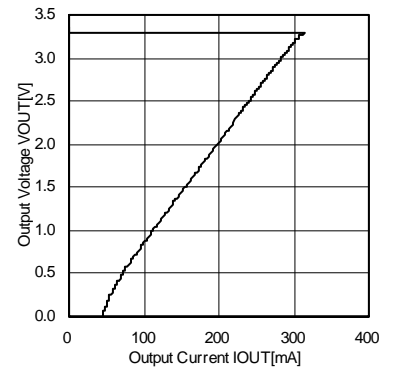

Fig. 9 Output Voltage vs Output Current (BH33RB1WGUT)

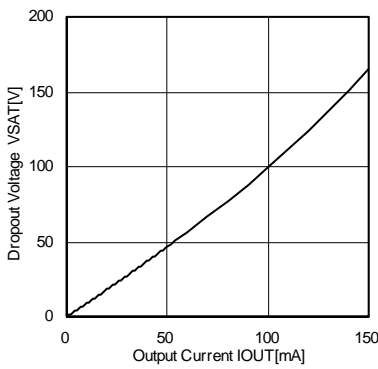

Fig. 10 Dropout Voltage vs Output Current (BH28RB1WGUT)

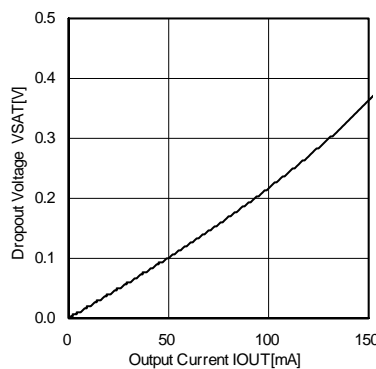

Fig. 11 Dropout Voltage vs Output Current (BH33RB1WGUT)

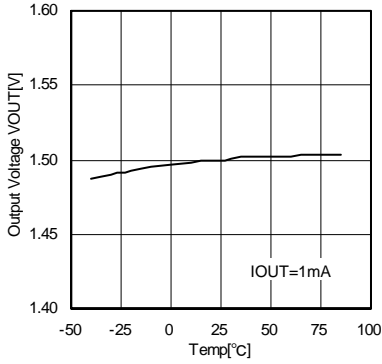

Fig. 12 Output Voltage vs Temperature (BH15RB1WGUT)

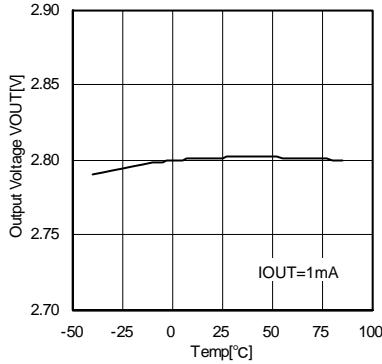

Fig. 13 Output Voltage vs Temperature (BH28RB1WGUT)

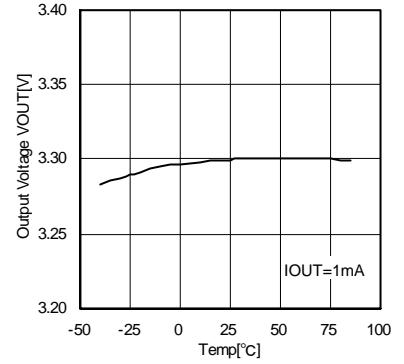

Fig. 14 Output Voltage vs Temperature (BH33RB1WGUT)

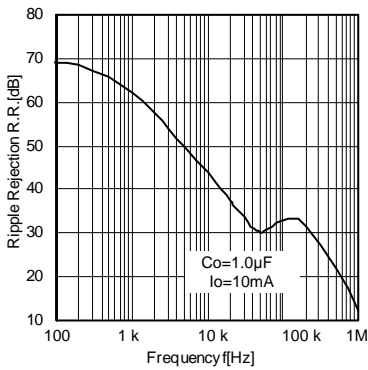

Fig. 15 Ripple Rejection (BH15RB1WGUT)

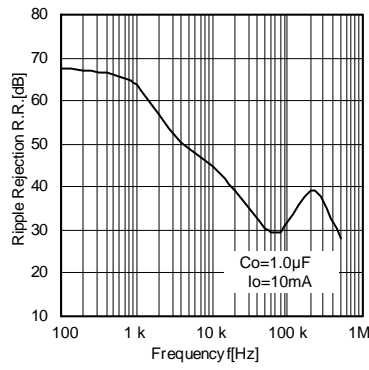

Fig. 16 Ripple Rejection (BH28RB1WGUT)

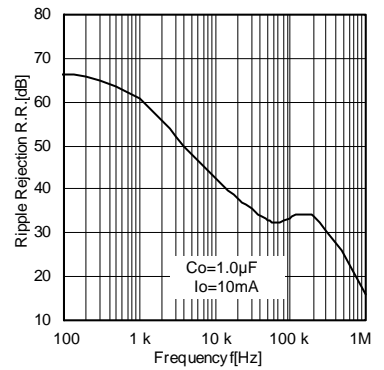

Fig. 17 Ripple Rejection (BH33RB1WGUT)

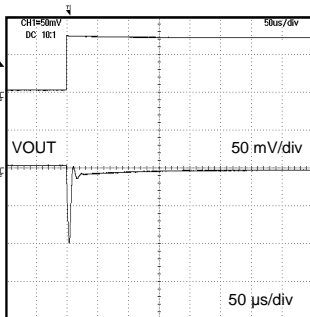

Fig. 18 Load Response (Co = 1.0 µF) (BH15RB1WGUT)

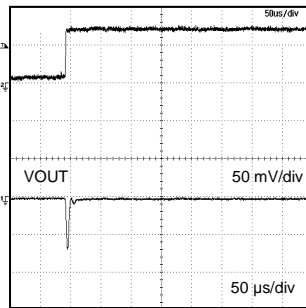

Fig. 19 Load Response (Co = 1.0 µF) (BH28RB1WGUT)

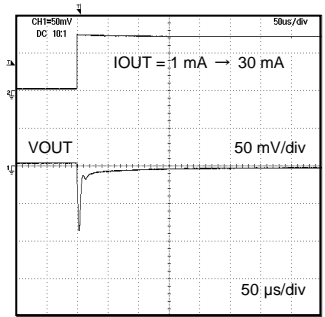

Fig. 20 Load Response (Co = 1.0 µF) (BH33RB1WGUT)

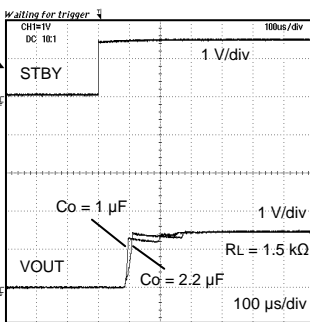

Fig. 21 Output Voltage Rise Time (BH15RB1WGUT)

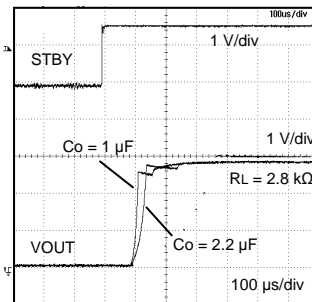

Fig. 22 Output Voltage Rise Time (BH28RB1WGUT)

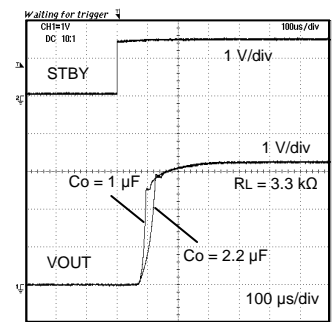
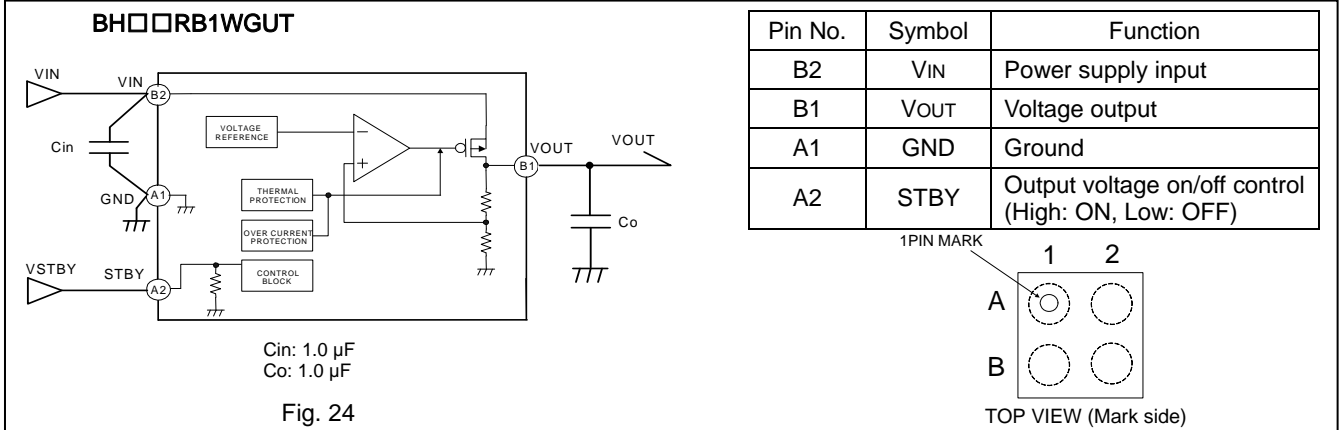

Fig. 23 Output Voltage Rise Time (BH33RB1WGUT)

●Block Diagram, Recommended Circuit Diagram, and Pin Assignment Diagram



●Power Dissipation (Pd)

1. Power dissipation (Pd)

Power dissipation calculations include output power dissipation characteristics and internal IC power consumption. In the event that the IC is used in an environment where this power dissipation is exceeded, the attendant rise in the junction temperature will trigger the thermal shutdown circuit, reducing the current capacity and otherwise degrading the IC's design performance. Allow for sufficient margins so that this power dissipation is not exceeded during IC operation.

Calculating the maximum internal IC power consumption (P_{MAX})

$$P_{MAX} = (V_{IN} - V_{OUT}) \times I_{OUT} (MAX.)$$

V_{IN}: Input voltage
V_{OUT}: Output voltage
I_{OUT} (MAX): Output current

2. Power dissipation/power dissipation reduction (Pd)

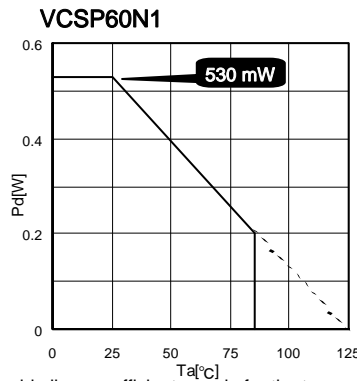

Board: 7 mm × 7 mm × 0.8 mm
Material: Glass epoxy PCB

*Circuit design should allow a sufficient margin for the temperature range for P_{MAX} < Pd.

Fig. 25 VCSP60N1 Power Dissipation/Power Dissipation Reduction (Example)

●Input Output Capacitors

It is recommended to insert bypass capacitors between input and GND pins, positioning them as close to the pins as possible. These capacitors are used when the power supply impedance increases or when long wiring paths are used, so they should be checked once the IC has been mounted. Ceramic capacitors generally have temperature and DC bias characteristics. Use X5R or X7R ceramic capacitors, which offer good temperature and DC bias characteristics as well as stable high voltages.

Typical ceramic capacitor characteristics

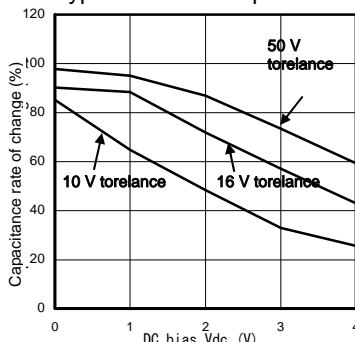

Fig. 26 Capacitance vs Bias (Y5V)

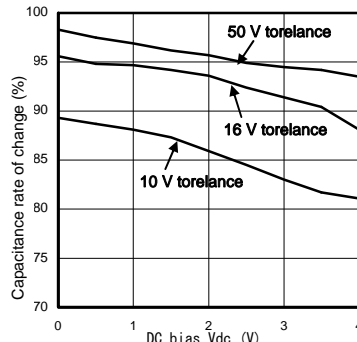

Fig.27 Capacitance vs Bias (X5R, X7R)

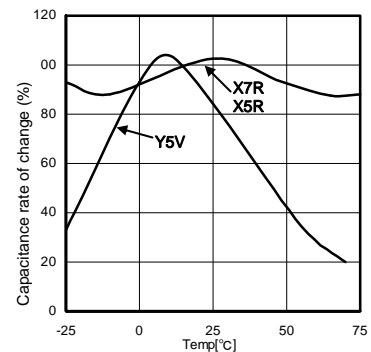

Fig. 28 Capacitance vs Temperature (X5R, X7R, Y5V)

●Output capacitors

Mounting input capacitor between input pin and GND (as close to pin as possible), and also output capacitor between output pin and GND(as close to pin as possible) is recommended. The input capacitor reduces the output impedance of the voltage supply source connected to the VCC. The higher value the output capacitor goes the more stable the whole operation becomes. This leads to high load transient response. Please confirm the whole operation on actual application board. Generally, ceramic capacitor has wide range of tolerance, temperature coefficient, and DC bias characteristic. And also its value goes lower as time progresses. Please choose ceramic capacitors after obtaining more detailed data by asking capacitor makers.

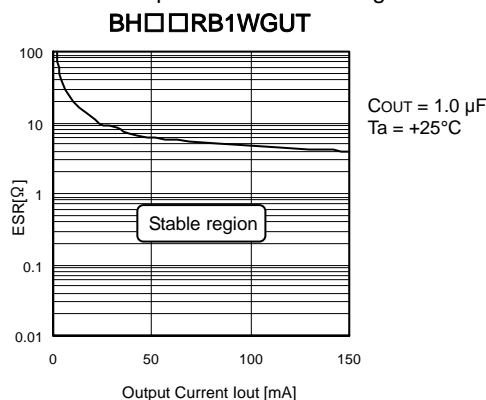

Fig. 29 Stable Operating Region Characteristics (Example)

●Operation Notes

1. Absolute maximum ratings

An excess in the absolute maximum ratings, such as supply voltage, temperature range of operating conditions, etc., can break down the devices, thus making impossible to identify breaking mode, such as a short circuit or an open circuit. If any over rated values will expect to exceed the absolute maximum ratings, consider adding circuit protection devices, such as fuses.

2. Thermal design

Use a thermal design that allows for a sufficient margin in light of the power dissipation (Pd) in actual operating conditions.

3. Inter-pin shorts and mounting errors

Use caution when positioning the IC for mounting on printed circuit boards. The IC may be damaged if there is any connection error or if pins are shorted together.

4. Thermal shutdown circuit (TSD)

The IC incorporates a built-in thermal shutdown circuit (TSD circuit). The thermal shutdown circuit is designed only to shut the IC off to prevent runaway thermal operation. It is not designed to protect the IC or guarantee its operation. Do not continue to use the IC after operating this circuit or use the IC in an environment where the operation of this circuit is assumed.

5. Overcurrent protection circuit

The IC incorporates a built-in overcurrent protection circuit that operates according to the output current capacity. This circuit serves to protect the IC from damage when the load is shorted. The protection circuit is designed to limit current flow by not latching in the event of a large and instantaneous current flow originating from a large capacitor or other component. These protection circuits are effective in preventing damage due to sudden and unexpected accidents. However, the IC should not be used in applications characterized by the continuous operation or transitioning of the protection circuits. At the time of thermal designing, keep in mind that the current capability has negative characteristics to temperatures.

6. Actions in strong electromagnetic field

Use caution when using the IC in the presence of a strong electromagnetic field as doing so may cause the IC to malfunction.

7. Ground wiring patterns

When using both small signal and large current GND patterns, it is recommended to isolate the two ground patterns, placing a single ground point at the ground potential of application so that the pattern wiring resistance and voltage variations caused by large currents do not cause variations in the small signal ground voltage. Be careful not to change the GND wiring pattern of any external components, either.

8. Influence of strong light

Exposure of the IC to strong light sources such as infrared light from a halogen lamp may cause the IC to malfunction. When it is necessary to use the IC in such environments, implement measures to block exposure to light from the light source. During testing, exposure to neither fluorescent lighting nor white LEDs had a significant effect on the IC.

9. GND voltage

The potential of GND pin must be minimum potential in all operating conditions.

10. Back Current

In applications where the IC may be exposed to back current flow, it is recommended to create a path to dissipate this current by inserting a bypass diode between the VIN and VOUT pins.

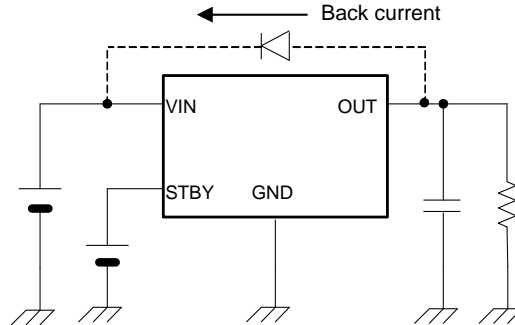

Fig. 30 Example Bypass Diode Connection

11. Testing on application boards

When testing the IC on an application board, connecting a capacitor to a pin with low impedance subjects the IC to stress. Always discharge capacitors after each process or step. Always turn the IC's power supply off before connecting it to or removing it from a jig or fixture during the inspection process. Ground the IC during assembly steps as an antistatic measure. Use similar precaution when transporting or storing the IC.

12. Regarding Input Pin of the IC (Fig.31)

This monolithic IC contains P+ isolation and P substrate layers between adjacent elements in order to keep them isolated. P-N junctions are formed at the intersection of these P layers with the N layers of other elements, creating a parasitic diode or transistor. For example, the relation between each potential is as follows:

When $GND > Pin A$ and $GND > Pin B$, the P-N junction operates as a parasitic diode.

When $GND > Pin B$, the P-N junction operates as a parasitic transistor.

Parasitic diodes can occur inevitable in the structure of the IC. The operation of parasitic diodes can result in mutual interference among circuits, operational faults, or physical damage. Accordingly, methods by which parasitic diodes operate, such as applying a voltage that is lower than the GND (P substrate) voltage to an input pin, should not be used.

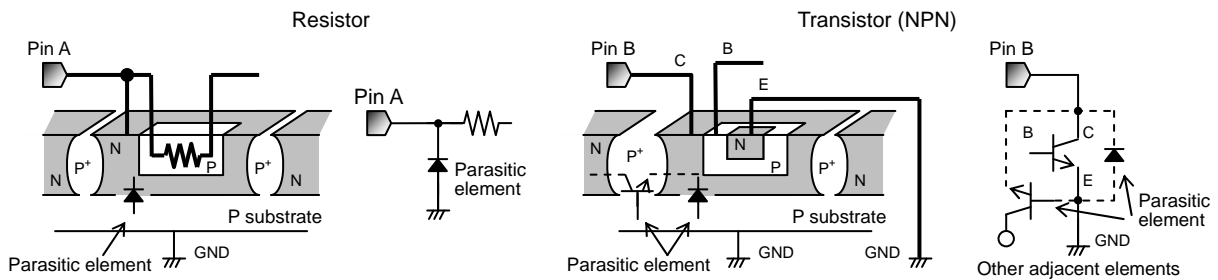
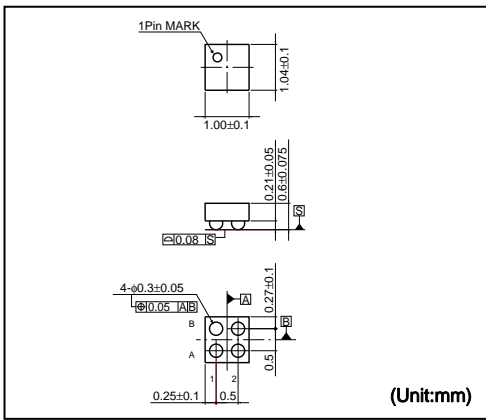

Fig. 31 Example of IC structure

●Ordering part number

B	H	1	5	R	B	1	W	G	U	T	-	E	2
Part No.		Output voltage 15: 1.5 V 18: 1.8 V 25: 2.5 V 28: 2.8 V 29: 2.9 V 30: 3.0 V 31: 3.1 V 33: 3.3 V		Series RB1 : High ripple rejection			Shutdown switch W : Includes switch	Package GUT: VCSP60N1			Packaging and forming specification E2: Embossed tape and reel		

VCSP60N1



<Tape and Reel information>

Tape	Embossed carrier tape
Quantity	3000pcs
Direction of feed	E2 (The direction is the 1pin of product is at the upper left when you hold reel on the left hand and you pull out the tape on the right hand.)

※When you order , please order in times the amount of package quantity.

Notice

Precaution on using ROHM Products

- Our Products are designed and manufactured for application in ordinary electronic equipments (such as AV equipment, OA equipment, telecommunication equipment, home electronic appliances, amusement equipment, etc.). If you intend to use our Products in devices requiring extremely high reliability (such as medical equipment ^(Note 1), transport equipment, traffic equipment, aircraft/spacecraft, nuclear power controllers, fuel controllers, car equipment including car accessories, safety devices, etc.) and whose malfunction or failure may cause loss of human life, bodily injury or serious damage to property ("Specific Applications"), please consult with the ROHM sales representative in advance. Unless otherwise agreed in writing by ROHM in advance, ROHM shall not be in any way responsible or liable for any damages, expenses or losses incurred by you or third parties arising from the use of any ROHM's Products for Specific Applications.

(Note1) Medical Equipment Classification of the Specific Applications

JAPAN	USA	EU	CHINA
CLASS III	CLASS III	CLASS II b	CLASS III
CLASS IV		CLASS III	

- ROHM designs and manufactures its Products subject to strict quality control system. However, semiconductor products can fail or malfunction at a certain rate. Please be sure to implement, at your own responsibilities, adequate safety measures including but not limited to fail-safe design against the physical injury, damage to any property, which a failure or malfunction of our Products may cause. The following are examples of safety measures:
 - Installation of protection circuits or other protective devices to improve system safety
 - Installation of redundant circuits to reduce the impact of single or multiple circuit failure
- Our Products are designed and manufactured for use under standard conditions and not under any special or extraordinary environments or conditions, as exemplified below. Accordingly, ROHM shall not be in any way responsible or liable for any damages, expenses or losses arising from the use of any ROHM's Products under any special or extraordinary environments or conditions. If you intend to use our Products under any special or extraordinary environments or conditions (as exemplified below), your independent verification and confirmation of product performance, reliability, etc. prior to use, must be necessary:
 - Use of our Products in any types of liquid, including water, oils, chemicals, and organic solvents
 - Use of our Products outdoors or in places where the Products are exposed to direct sunlight or dust
 - Use of our Products in places where the Products are exposed to sea wind or corrosive gases, including Cl₂, H₂S, NH₃, SO₂, and NO₂
 - Use of our Products in places where the Products are exposed to static electricity or electromagnetic waves
 - Use of our Products in proximity to heat-producing components, plastic cords, or other flammable items
 - Sealing or coating our Products with resin or other coating materials
 - Use of our Products without cleaning residue of flux (even if you use no-clean type fluxes, cleaning residue of flux is recommended); or Washing our Products by using water or water-soluble cleaning agents for cleaning residue after soldering
 - Use of the Products in places subject to dew condensation
- The Products are not subject to radiation-proof design.
- Please verify and confirm characteristics of the final or mounted products in using the Products.
- In particular, if a transient load (a large amount of load applied in a short period of time, such as pulse. is applied, confirmation of performance characteristics after on-board mounting is strongly recommended. Avoid applying power exceeding normal rated power; exceeding the power rating under steady-state loading condition may negatively affect product performance and reliability.
- De-rate Power Dissipation (Pd) depending on Ambient temperature (Ta). When used in sealed area, confirm the actual ambient temperature.
- Confirm that operation temperature is within the specified range described in the product specification.
- ROHM shall not be in any way responsible or liable for failure induced under deviant condition from what is defined in this document.

Precaution for Mounting / Circuit board design

- When a highly active halogenous (chlorine, bromine, etc.) flux is used, the residue of flux may negatively affect product performance and reliability.
- In principle, the reflow soldering method must be used; if flow soldering method is preferred, please consult with the ROHM representative in advance.

For details, please refer to ROHM Mounting specification

Precautions Regarding Application Examples and External Circuits

1. If change is made to the constant of an external circuit, please allow a sufficient margin considering variations of the characteristics of the Products and external components, including transient characteristics, as well as static characteristics.
2. You agree that application notes, reference designs, and associated data and information contained in this document are presented only as guidance for Products use. Therefore, in case you use such information, you are solely responsible for it and you must exercise your own independent verification and judgment in the use of such information contained in this document. ROHM shall not be in any way responsible or liable for any damages, expenses or losses incurred by you or third parties arising from the use of such information.

Precaution for Electrostatic

This Product is electrostatic sensitive product, which may be damaged due to electrostatic discharge. Please take proper caution in your manufacturing process and storage so that voltage exceeding the Products maximum rating will not be applied to Products. Please take special care under dry condition (e.g. Grounding of human body / equipment / solder iron, isolation from charged objects, setting of Ionizer, friction prevention and temperature / humidity control).

Precaution for Storage / Transportation

1. Product performance and soldered connections may deteriorate if the Products are stored in the places where:
 - [a] the Products are exposed to sea winds or corrosive gases, including Cl₂, H₂S, NH₃, SO₂, and NO₂
 - [b] the temperature or humidity exceeds those recommended by ROHM
 - [c] the Products are exposed to direct sunshine or condensation
 - [d] the Products are exposed to high Electrostatic
2. Even under ROHM recommended storage condition, solderability of products out of recommended storage time period may be degraded. It is strongly recommended to confirm solderability before using Products of which storage time is exceeding the recommended storage time period.
3. Store / transport cartons in the correct direction, which is indicated on a carton with a symbol. Otherwise bent leads may occur due to excessive stress applied when dropping of a carton.
4. Use Products within the specified time after opening a humidity barrier bag. Baking is required before using Products of which storage time is exceeding the recommended storage time period.

Precaution for Product Label

QR code printed on ROHM Products label is for ROHM's internal use only.

Precaution for Disposition

When disposing Products please dispose them properly using an authorized industry waste company.

Precaution for Foreign Exchange and Foreign Trade act

Since our Products might fall under controlled goods prescribed by the applicable foreign exchange and foreign trade act, please consult with ROHM representative in case of export.

Precaution Regarding Intellectual Property Rights

1. All information and data including but not limited to application example contained in this document is for reference only. ROHM does not warrant that foregoing information or data will not infringe any intellectual property rights or any other rights of any third party regarding such information or data. ROHM shall not be in any way responsible or liable for infringement of any intellectual property rights or other damages arising from use of such information or data.:
2. No license, expressly or implied, is granted hereby under any intellectual property rights or other rights of ROHM or any third parties with respect to the information contained in this document.

Other Precaution

1. This document may not be reprinted or reproduced, in whole or in part, without prior written consent of ROHM.
2. The Products may not be disassembled, converted, modified, reproduced or otherwise changed without prior written consent of ROHM.
3. In no event shall you use in any way whatsoever the Products and the related technical information contained in the Products or this document for any military purposes, including but not limited to, the development of mass-destruction weapons.
4. The proper names of companies or products described in this document are trademarks or registered trademarks of ROHM, its affiliated companies or third parties.

General Precaution

1. Before you use our Products, you are requested to carefully read this document and fully understand its contents. ROHM shall not be in any way responsible or liable for failure, malfunction or accident arising from the use of any ROHM's Products against warning, caution or note contained in this document.
2. All information contained in this document is current as of the issuing date and subject to change without any prior notice. Before purchasing or using ROHM's Products, please confirm the latest information with a ROHM sales representative.
3. The information contained in this document is provided on an "as is" basis and ROHM does not warrant that all information contained in this document is accurate and/or error-free. ROHM shall not be in any way responsible or liable for any damages, expenses or losses incurred by you or third parties resulting from inaccuracy or errors of or concerning such information.

Mouser Electronics

Authorized Distributor

Click to View Pricing, Inventory, Delivery & Lifecycle Information:

ROHM Semiconductor:

[BH15RB1WGUT-E2](#) [BH18RB1WGUT-E2](#) [BH25RB1WGUT-E2](#) [BH28RB1WGUT-E2](#) [BH29RB1WGUT-E2](#)
[BH30RB1WGUT-E2](#) [BH31RB1WGUT-E2](#) [BH33RB1WGUT-E2](#)

Компания «Океан Электроники» предлагает заключение долгосрочных отношений при поставках импортных электронных компонентов на взаимовыгодных условиях!

Наши преимущества:

- Поставка оригинальных импортных электронных компонентов напрямую с производств Америки, Европы и Азии, а так же с крупнейших складов мира;
- Широкая линейка поставок активных и пассивных импортных электронных компонентов (более 30 млн. наименований);
- Поставка сложных, дефицитных, либо снятых с производства позиций;
- Оперативные сроки поставки под заказ (от 5 рабочих дней);
- Экспресс доставка в любую точку России;
- Помощь Конструкторского Отдела и консультации квалифицированных инженеров;
- Техническая поддержка проекта, помощь в подборе аналогов, поставка прототипов;
- Поставка электронных компонентов под контролем ВП;
- Система менеджмента качества сертифицирована по Международному стандарту ISO 9001;
- При необходимости вся продукция военного и аэрокосмического назначения проходит испытания и сертификацию в лаборатории (по согласованию с заказчиком);
- Поставка специализированных компонентов военного и аэрокосмического уровня качества (Xilinx, Altera, Analog Devices, Intersil, Interpoint, Microsemi, Actel, Aeroflex, Peregrine, VPT, Syfer, Eurofarad, Texas Instruments, MS Kennedy, Miteq, Cobham, E2V, MA-COM, Hittite, Mini-Circuits, General Dynamics и др.);

Компания «Океан Электроники» является официальным дистрибьютором и эксклюзивным представителем в России одного из крупнейших производителей разъемов военного и аэрокосмического назначения «JONHON», а так же официальным дистрибьютором и эксклюзивным представителем в России производителя высокотехнологичных и надежных решений для передачи СВЧ сигналов «FORSTAR».



JONHON

«JONHON» (основан в 1970 г.)

Разъемы специального, военного и аэрокосмического назначения:

(Применяются в военной, авиационной, аэрокосмической, морской, железнодорожной, горно- и нефтедобывающей отраслях промышленности)

«FORSTAR» (основан в 1998 г.)

ВЧ соединители, коаксиальные кабели, кабельные сборки и микроволновые компоненты:

(Применяются в телекоммуникациях гражданского и специального назначения, в средствах связи, РЛС, а так же военной, авиационной и аэрокосмической отраслях промышленности).



Телефон: 8 (812) 309-75-97 (многоканальный)

Факс: 8 (812) 320-03-32

Электронная почта: ocean@oceanchips.ru

Web: <http://oceanchips.ru/>

Адрес: 198099, г. Санкт-Петербург, ул. Калинина, д. 2, корп. 4, лит. А