

# MBRS230LT3

## Surface Mount Schottky Power Rectifier

### SMB Power Surface Mount Package

This device employs the Schottky Barrier principle in a metal-to-silicon power rectifier. Features epitaxial construction with oxide passivation and metal overlay contact. Ideally suited for low voltage, high frequency switching power supplies; free wheeling diodes and polarity protection diodes.

#### Features

- Compact Package with J-Bend Leads Ideal for Automated Handling
- Highly Stable Oxide Passivated Junction
- Guardring for Over-Voltage Protection
- Low Forward Voltage Drop
- Pb-Free Package is Available

#### Mechanical Characteristics

- Case: Molded Epoxy
- Epoxy Meets UL 94, V-0 @ 0.125 in.
- Weight: 95 mg (approximately)
- Finish: All External Surfaces Corrosion Resistant and Terminal Leads are Readily Solderable
- Maximum Temperature of 260°C/10 Seconds for Soldering
- Available in 12 mm Tape, 2500 Units per 13" Reel, Add "T3" Suffix to Part Number
- Cathode Polarity Band



ON Semiconductor®

<http://onsemi.com>

**SCHOTTKY BARRIER  
RECTIFIER  
2.0 AMPERES  
30 VOLTS**



**SMB  
CASE 403A  
PLASTIC**

#### MARKING DIAGRAM

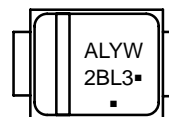

A = Assembly Location  
L = Wafer Lot  
Y = Year  
W = Work Week  
▪ = Pb-Free Package

(Note: Microdot may be in either location)

#### ORDERING INFORMATION

Device	Package	Shipping†
MBRS230LT3	SMB	2500/Tape & Reel
MBRS230LT3G	SMB (Pb-Free)	2500/Tape & Reel

†For information on tape and reel specifications, including part orientation and tape sizes, please refer to our Tape and Reel Packaging Specifications Brochure, BRD8011/D.

# MBRS230LT3

## MAXIMUM RATINGS

Rating	Symbol	Value	Unit
Peak Repetitive Reverse Voltage Working Peak Reverse Voltage DC Blocking Voltage	$V_{RRM}$ $V_{RWM}$ $V_R$	30	V
Average Rectified Forward Current (At Rated $V_R$ , $T_C = 110^\circ\text{C}$ )	$I_O$	2.0	A
Peak Repetitive Forward Current (At Rated $V_R$ , Square Wave, 20 kHz, $T_C = 105^\circ\text{C}$ )	$I_{FRM}$	4.0	A
Non-Repetitive Peak Surge Current (Surge Applied at Rated Load Conditions, Halfwave, Single Phase, 60 Hz)	$I_{FSM}$	40	A
Storage/Operating Case Temperature	$T_{stg}, T_C$	-55 to +175	$^\circ\text{C}$
Operating Junction Temperature	$T_J$	-55 to +125	$^\circ\text{C}$
Voltage Rate of Change (Rated $V_R$ , $T_J = 25^\circ\text{C}$ )	$dv/dt$	10,000	V/ $\mu\text{s}$

Maximum ratings are those values beyond which device damage can occur. Maximum ratings applied to the device are individual stress limit values (not normal operating conditions) and are not valid simultaneously. If these limits are exceeded, device functional operation is not implied, damage may occur and reliability may be affected.

## THERMAL CHARACTERISTICS

Characteristic	Symbol	Value	Unit
Thermal Resistance, Junction-to-Lead (Note 1)	$R_{\theta JL}$	18.6	$^\circ\text{C/W}$
Thermal Resistance, Junction-to-Ambient (Note 1)	$R_{\theta JA}$	135	

## ELECTRICAL CHARACTERISTICS

Maximum Instantaneous Forward Voltage (Note 2)  see Figure 2  ( $I_F = 2.0\text{ A}$ ) ( $I_F = 4.0\text{ A}$ )	$V_F$	$T_J = 25^\circ\text{C}$	$T_J = 125^\circ\text{C}$	V
		0.50 0.60	0.45 0.63	
Maximum Instantaneous Reverse Current (Note 2)  see Figure 4  ( $V_R = 30\text{ V}$ ) ( $V_R = 15\text{ V}$ )	$I_R$	$T_J = 25^\circ\text{C}$	$T_J = 125^\circ\text{C}$	mA
		1 0.31	75 35	

1. Minimum pad size (0.108" X 0.085") for each lead on FR4 board.
2. Pulse Test: Pulse Width  $\leq 250\ \mu\text{s}$ , Duty Cycle  $\leq 2.0\%$ .

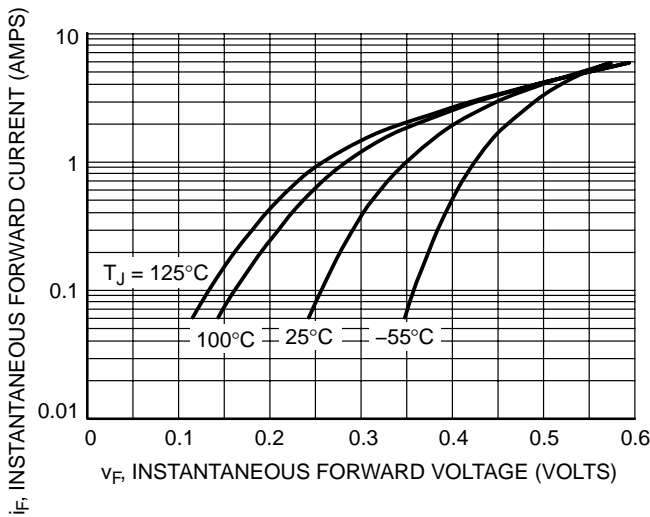

Figure 1. Typical Forward Voltage

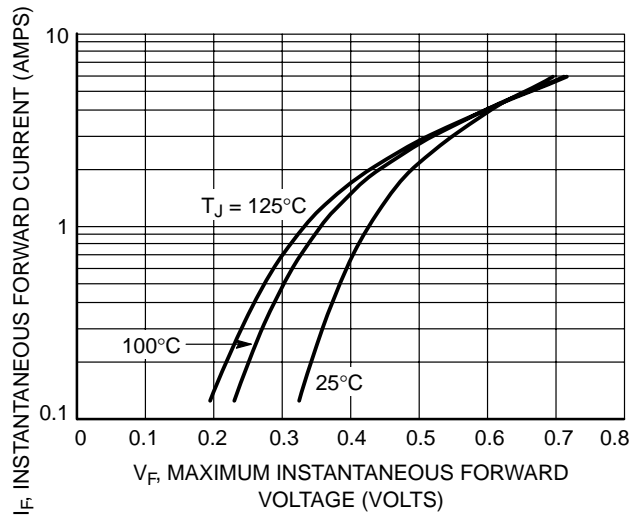

Figure 2. Maximum Forward Voltage

# MBRS230LT3

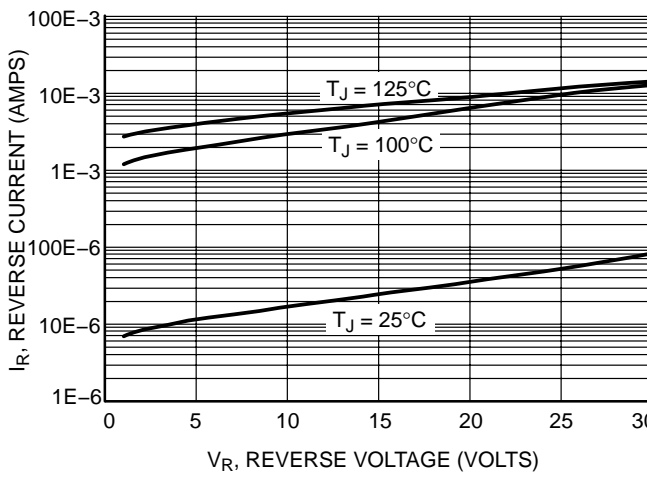

Figure 3. Typical Reverse Current

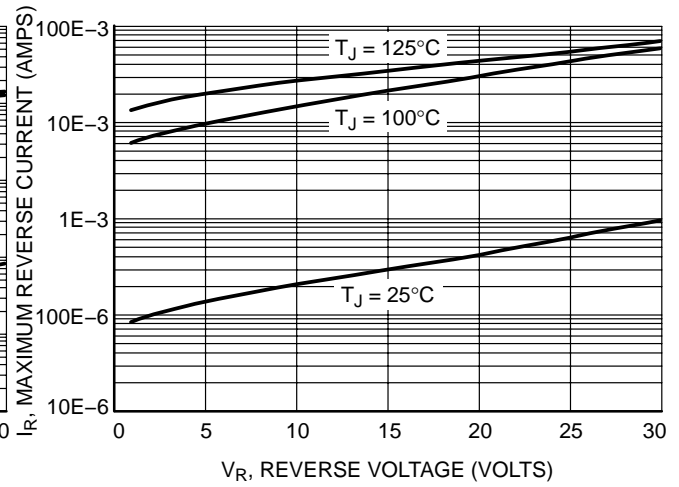

Figure 4. Maximum Reverse Current

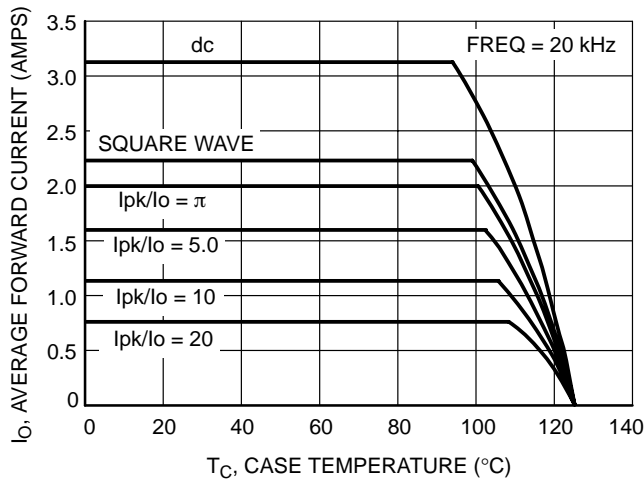

Figure 5. Current Derating Per Leg

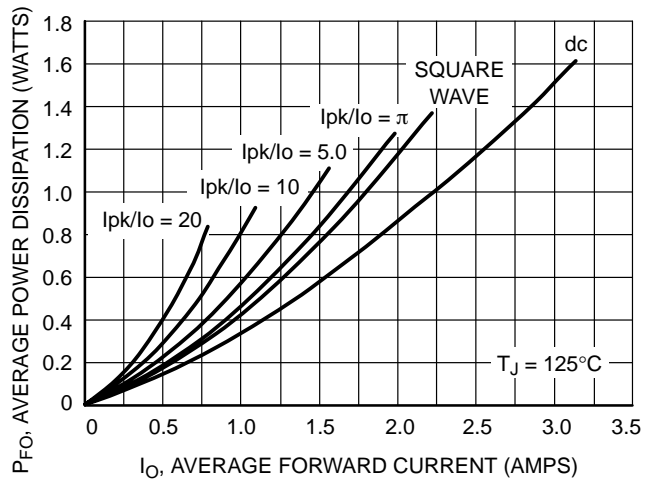

Figure 6. Forward Power Dissipation Per Leg

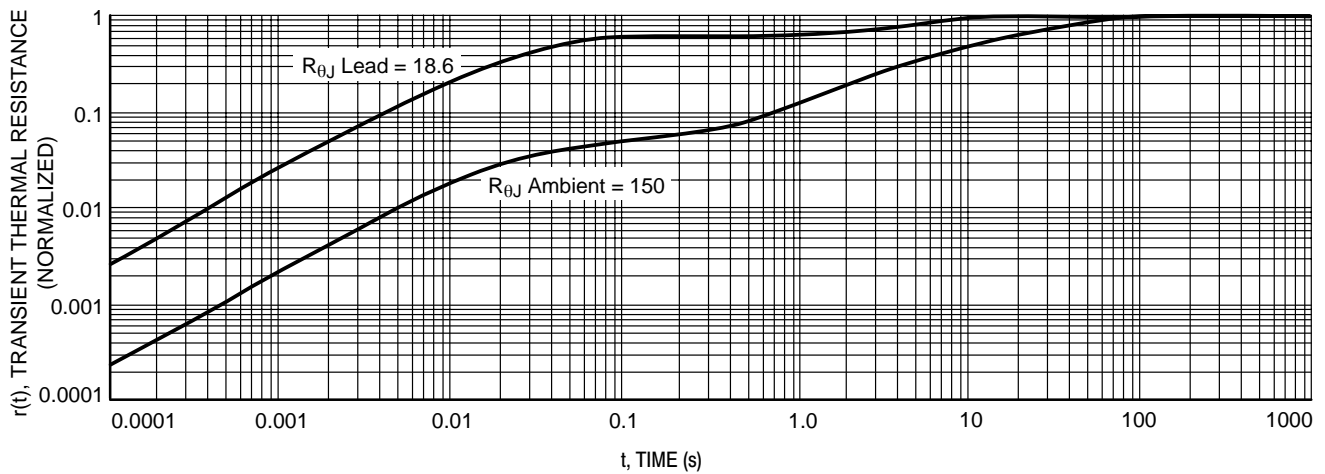
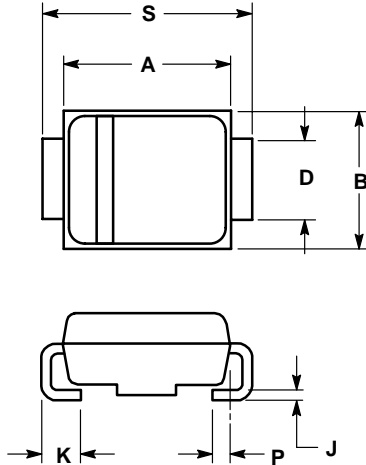

Figure 7. Thermal Response

# MBRS230LT3

## PACKAGE DIMENSIONS

### SMB PLASTIC PACKAGE CASE 403A-03 ISSUE D



#### NOTES:

1. DIMENSIONING AND TOLERANCING PER ANSI Y14.5M, 1982.
2. CONTROLLING DIMENSION: INCH.
3. D DIMENSION SHALL BE MEASURED WITHIN DIMENSION P.

DIM	INCHES		MILLIMETERS	
	MIN	MAX	MIN	MAX
A	0.160	0.180	4.06	4.57
B	0.130	0.150	3.30	3.81
C	0.075	0.095	1.90	2.41
D	0.077	0.083	1.96	2.11
H	0.0020	0.0060	0.051	0.152
J	0.006	0.012	0.15	0.30
K	0.030	0.050	0.76	1.27
P	0.020	REF	0.51	REF
S	0.205	0.220	5.21	5.59

### SOLDERING FOOTPRINT\*

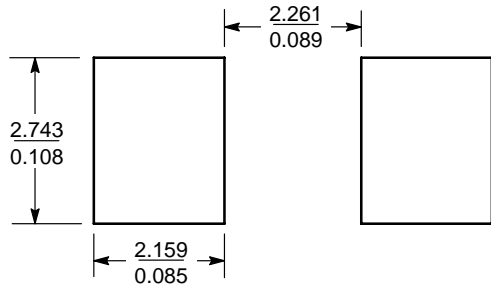

SCALE 8:1  $\left(\frac{\text{mm}}{\text{inches}}\right)$

\*For additional information on our Pb-Free strategy and soldering details, please download the ON Semiconductor Soldering and Mounting Techniques Reference Manual, SOLDERRM/D.

ON Semiconductor and  are registered trademarks of Semiconductor Components Industries, LLC (SCILLC). SCILLC reserves the right to make changes without further notice to any products herein. SCILLC makes no warranty, representation or guarantee regarding the suitability of its products for any particular purpose, nor does SCILLC assume any liability arising out of the application or use of any product or circuit, and specifically disclaims any and all liability, including without limitation special, consequential or incidental damages. "Typical" parameters which may be provided in SCILLC data sheets and/or specifications can and do vary in different applications and actual performance may vary over time. All operating parameters, including "Typicals" must be validated for each customer application by customer's technical experts. SCILLC does not convey any license under its patent rights nor the rights of others. SCILLC products are not designed, intended, or authorized for use as components in systems intended for surgical implant into the body, or other applications intended to support or sustain life, or for any other application in which the failure of the SCILLC product could create a situation where personal injury or death may occur. Should Buyer purchase or use SCILLC products for any such unintended or unauthorized application, Buyer shall indemnify and hold SCILLC and its officers, employees, subsidiaries, affiliates, and distributors harmless against all claims, costs, damages, and expenses, and reasonable attorney fees arising out of, directly or indirectly, any claim of personal injury or death associated with such unintended or unauthorized use, even if such claim alleges that SCILLC was negligent regarding the design or manufacture of the part. SCILLC is an Equal Opportunity/Affirmative Action Employer. This literature is subject to all applicable copyright laws and is not for resale in any manner.

### PUBLICATION ORDERING INFORMATION

#### LITERATURE FULFILLMENT:

Literature Distribution Center for ON Semiconductor  
P.O. Box 61312, Phoenix, Arizona 85082-1312 USA

Phone: 480-829-7710 or 800-344-3860 Toll Free USA/Canada

Fax: 480-829-7709 or 800-344-3867 Toll Free USA/Canada

Email: orderlit@onsemi.com

N. American Technical Support: 800-282-9855 Toll Free  
USA/Canada

Japan: ON Semiconductor, Japan Customer Focus Center  
2-9-1 Kamimeguro, Meguro-ku, Tokyo, Japan 153-0051  
Phone: 81-3-5773-3850

ON Semiconductor Website: <http://onsemi.com>

Order Literature: <http://www.onsemi.com/litorder>

For additional information, please contact your  
local Sales Representative.

Компания «Океан Электроники» предлагает заключение долгосрочных отношений при поставках импортных электронных компонентов на взаимовыгодных условиях!

Наши преимущества:

- Поставка оригинальных импортных электронных компонентов напрямую с производств Америки, Европы и Азии, а так же с крупнейших складов мира;
- Широкая линейка поставок активных и пассивных импортных электронных компонентов (более 30 млн. наименований);
- Поставка сложных, дефицитных, либо снятых с производства позиций;
- Оперативные сроки поставки под заказ (от 5 рабочих дней);
- Экспресс доставка в любую точку России;
- Помощь Конструкторского Отдела и консультации квалифицированных инженеров;
- Техническая поддержка проекта, помощь в подборе аналогов, поставка прототипов;
- Поставка электронных компонентов под контролем ВП;
- Система менеджмента качества сертифицирована по Международному стандарту ISO 9001;
- При необходимости вся продукция военного и аэрокосмического назначения проходит испытания и сертификацию в лаборатории (по согласованию с заказчиком);
- Поставка специализированных компонентов военного и аэрокосмического уровня качества (Xilinx, Altera, Analog Devices, Intersil, Interpoint, Microsemi, Actel, Aeroflex, Peregrine, VPT, Syfer, Eurofarad, Texas Instruments, MS Kennedy, Miteq, Cobham, E2V, MA-COM, Hittite, Mini-Circuits, General Dynamics и др.);

Компания «Океан Электроники» является официальным дистрибьютором и эксклюзивным представителем в России одного из крупнейших производителей разъемов военного и аэрокосмического назначения «JONHON», а так же официальным дистрибьютором и эксклюзивным представителем в России производителя высокотехнологичных и надежных решений для передачи СВЧ сигналов «FORSTAR».



## JONHON

«JONHON» (основан в 1970 г.)

Разъемы специального, военного и аэрокосмического назначения:

(Применяются в военной, авиационной, аэрокосмической, морской, железнодорожной, горно- и нефтедобывающей отраслях промышленности)

«FORSTAR» (основан в 1998 г.)

ВЧ соединители, коаксиальные кабели, кабельные сборки и микроволновые компоненты:

(Применяются в телекоммуникациях гражданского и специального назначения, в средствах связи, РЛС, а так же военной, авиационной и аэрокосмической отраслях промышленности).



Телефон: 8 (812) 309-75-97 (многоканальный)

Факс: 8 (812) 320-03-32

Электронная почта: [ocean@oceanchips.ru](mailto:ocean@oceanchips.ru)

Web: <http://oceanchips.ru/>

Адрес: 198099, г. Санкт-Петербург, ул. Калинина, д. 2, корп. 4, лит. А