

## Si85XX UNIDIRECTIONAL AC CURRENT SENSOR TARGET BOARD USER'S GUIDE

### 1. Introduction

The Si85xx products are unidirectional ac current sensors available with full-scale current sense input ranges of 5, 10, and 20 Amps. Si85xx products are ideal upgrades for older current sensing technologies offering size, performance, and cost advantages over current transformers, Hall Effect devices, DCR circuits, and other approaches. The Si85xx are extremely low loss, adding less than 1.3 mΩ of series resistance and less than 2 nH series inductance in the sensing path at 25 °C. Current-sensing terminals are isolated from the other package pins, providing 1000 V<sub>RMS</sub> of isolation with the 4x4x1 mm QFN package and 5000 V<sub>RMS</sub> of isolation with the wide-body, 20-pin SOIC package.

### 2. Kit Contents

The Si85xx Unidirectional AC Current Sensor Development Kit contains one of two versions of the 10 Amp, Si8512-based evaluation board or one version of the 20 Amp Si8513 based evaluation board. See "8. Ordering Guide" on page 10 for part number details for the 1 kV (QFN) or 5 kV (SOIC).

### 3. Hardware Overview

The Si85xx Target Boards shown in Figures 1, 2, and 3 provide a means of evaluating the ac current sensor in an existing application. The boards are meant to be soldered directly into a user's existing power supply and come with either the Si8512 installed (10 Amp full-scale input range) or with the Si8513 installed (20 Amp full-scale input range). For more information, refer to the Si85xx data sheet.

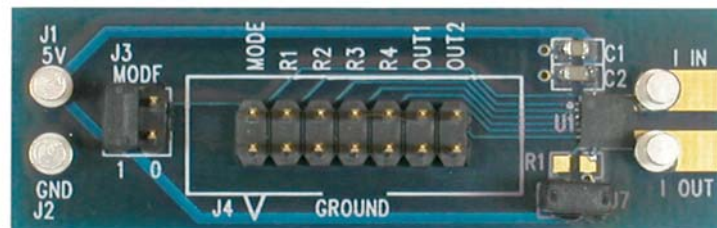

Figure 1. Si85xx-TB Overview (1 kV, 10 Amp Target Board)

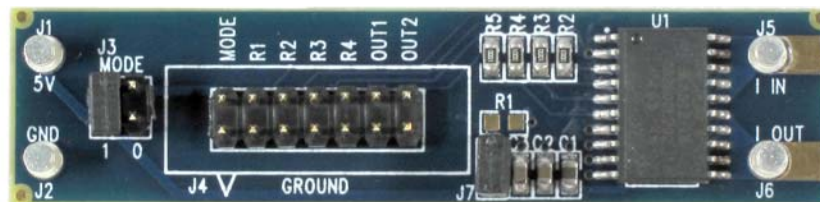

Figure 2. Si85xx5kV-TB Overview (5 kV, 10 Amp Target Board)

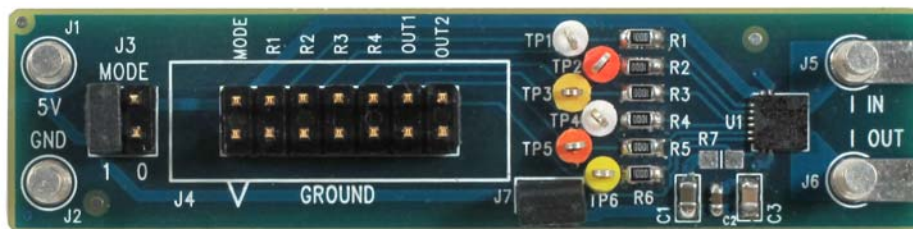
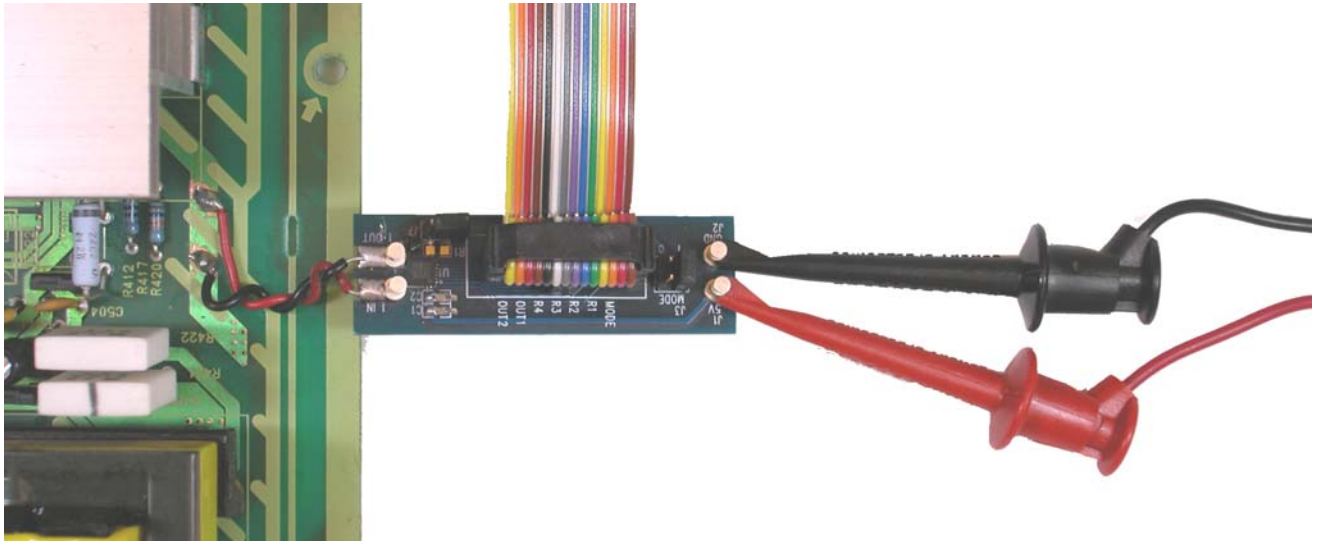

Figure 3. Si85xx20AQFN-TB Overview (1 kV, 20 Amp Target Board)

# Si85xx Target Board User's Guide

## 4. Target Board Hardwired to Single-Phase POL

Figure 4 illustrates the Si85xx-TB (1 kV, 10 Amp target board) soldered directly into a single-phase POL. The single-phase POL is designed to operate at a 400 kHz switch rate and provides better than 90 percent efficiency. It also provides 10 amps of peak current to the load and protects the supply by shutting down in the event of an overcurrent condition.



**Figure 4. Si85xx-EVB Hardwired to Single-Phase POL (1 kV Target Board)**

Figure 5 shows the Si8512 accurately monitoring the POL's switching current. As shown in the scope plot, a 1.6 V peak output voltage accurately monitors the 8 Amp peak, 50 percent duty cycle, 400 kHz current signal of the POL. A 20 mΩ sense resistor in series with the Si85xx is also monitored via a differential probe to provide a baseline measurement of the POL.

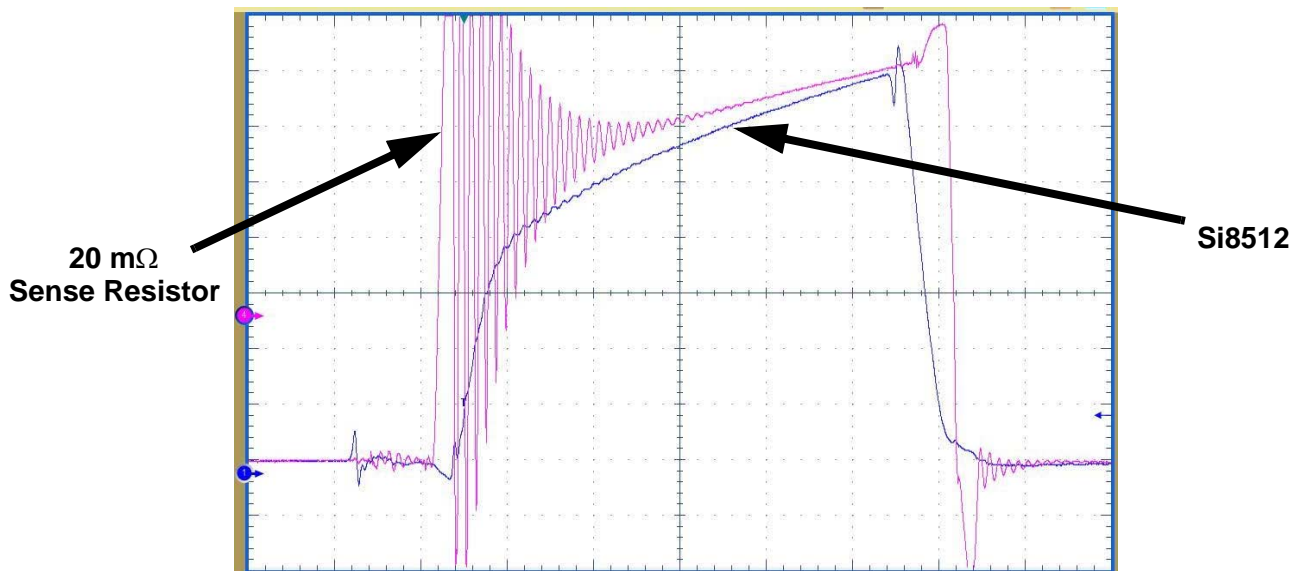

**Figure 5. Si85xx-TB OUT1 Oscilloscope Plot**

To accommodate this test, the Si85xx-TB was powered with a 5 V (100 mA) supply connected from J1 to J2. R1 was soldered from J4 to the respective phase control line of the POL. R2 and R4 were jumped to GND on J4. R3 was tied to 5 V, and the Mode pin was jumped to V<sub>DD</sub> via J7.

# Si85xx Target Board User's Guide

## 5. Si85xx Evaluation Board

The boards come with either the Si8512 installed (10 Amp full-scale input range) or with the Si8513 installed (20 Amp full-scale input range). Refer to Figures 6, 7, and 8 for the locations of the various I/O connectors and major components. Note that 100  $\Omega$  resistors were added in series to the R1 to R4 control lines on the 5 kV, 10 Amp target board and to the 20 Amp QFN target board to reduce inductive ringing from excessively long wires; these are optional for the end-system design.

- J1        5 V Supply Input power connection 5 V, 100 mA
- J2        GND, Input Supply power return connection, 0 V
- J3        HDR-2X2, Mode Control input
- J4        HDR-2X7, R1, R2, R3, R4 inputs, OUT1, OUT2 outputs, and seven GND return pins
- J5        IIN Positive Current Sense Input
- J6        IOOUT Negative/return Current Sense Input
- J7        HEADER, TRST timing select jumper, default tied to VDD

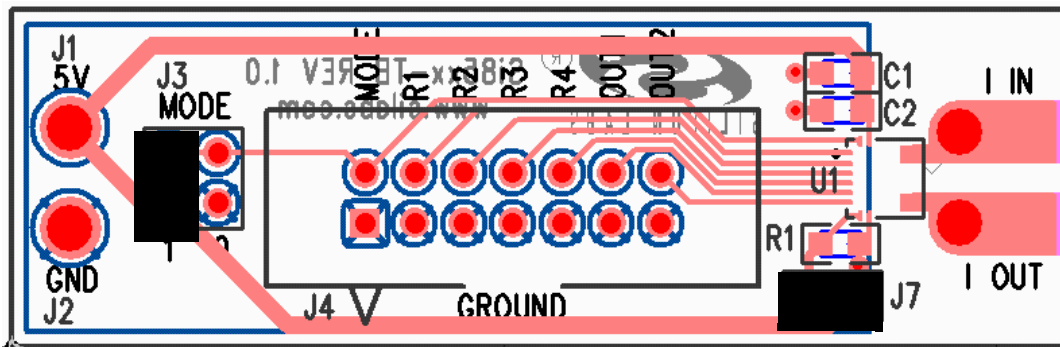

Figure 6. Final Setup (1 kV, 10 Amp Target Board)

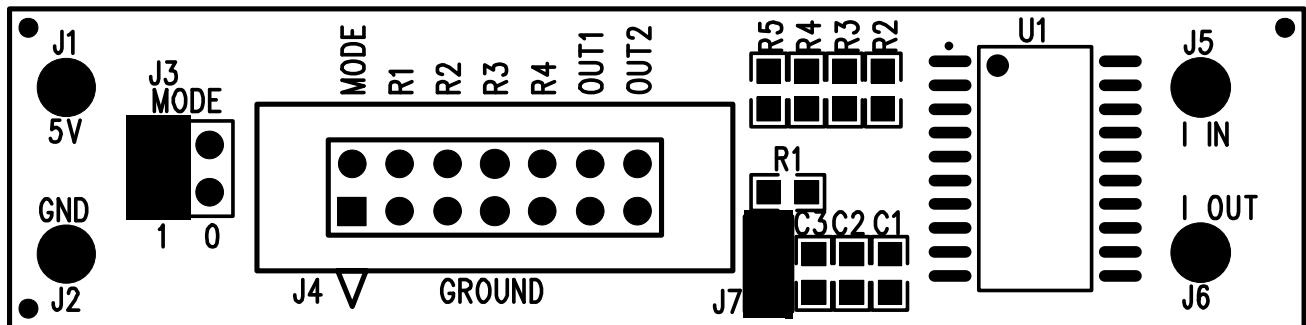

Figure 7. Final Setup (5 kV, 10 Amp Target Board)

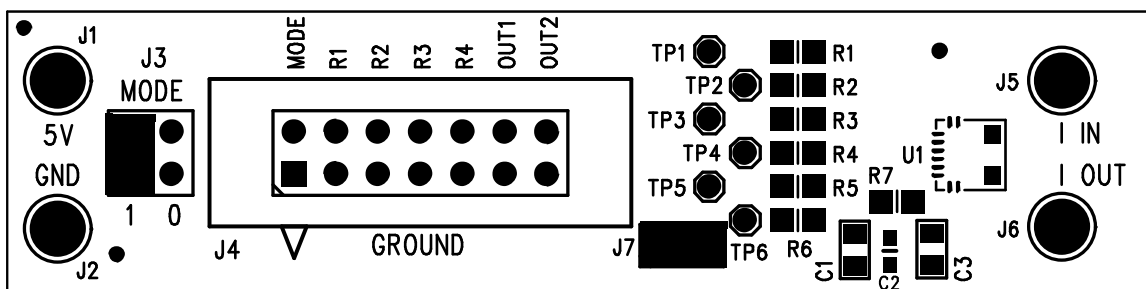

Figure 8. Final Setup (1 kV, 20 Amp Target Board)

# Si85xx Target Board User's Guide

## 5.1. VIN (J1, J2)

The user-provided power supply should be connected to connectors J1 and J2, where J2 is the reference. The power source must provide up to 5 V with at least 100 mA output current.

**Table 1. J1, J2 Pin Descriptions**

Jumper #	Description
J1	5 V, 100 mA
J2	GND

## 5.2. Mode Pin (J3)

Connector J3 is the Mode Control header. The user should tie this pin to either VDD or GND depending on the power supply topology being tested.

**Table 2. J3 Pin Descriptions**

Jumper #	Description
J3	VDD or GND

## 5.3. R1, R2, R3, R4 Inputs, OUT1, OUT2 Outputs (J4)

Connector J4 is used to provide the control inputs (R1, R2, R3, R4, MODE) to the Si85xx. It also provides the output voltage of the sensed input current on OUT1 and OUT2.

**Table 3. J4 Pin Descriptions**

Jumper #	Description
J4	R1, R2, R3, R4, OUT1, OUT2, GND

## 5.4. IIN (J5)

Connector J5 is used to provide the positive current sense input to the Si85xx device.

**Table 4. J5 Pin Descriptions**

Jumper #	Description
J5	IIN

## 5.5. IOUT (J6)

Connector J6 is used to provide the negative/return current sense input to the Si85xx device.

**Table 5. J6 Pin Descriptions**

Jumper #	Description
J6	IOUT

## 5.6. TRST RESET (J7)

Connector J7 is used to set the timing for the Si85xx integrator. J7 defaults to Reset option 1 where TRST is tied VDD providing approximately 200 ns of reset time. Reset option 2 is selected by connecting a timing resistor (R1 in Figures 9 and 10 and R7 in Figure 11) from the TRST input to ground.

**Table 6. J7 Pin Descriptions**

Jumper #	Description
J7	TRST—VDD or R1 to GND

## 6. Schematics

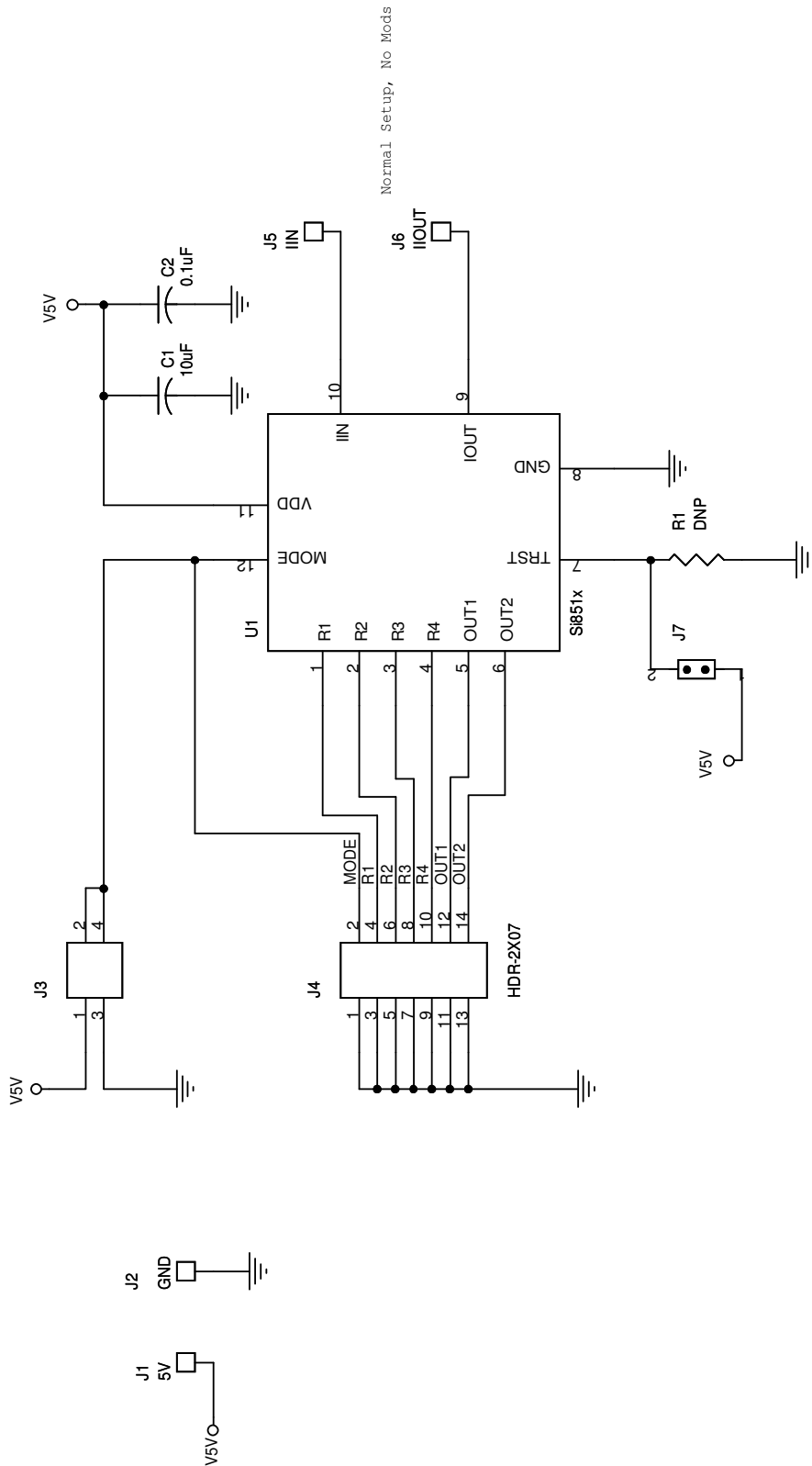

Figure 9. Si85xx-TB Target Board Schematic (1 kV, 10 Amp Target Board)

# Si85xx Target Board User's Guide

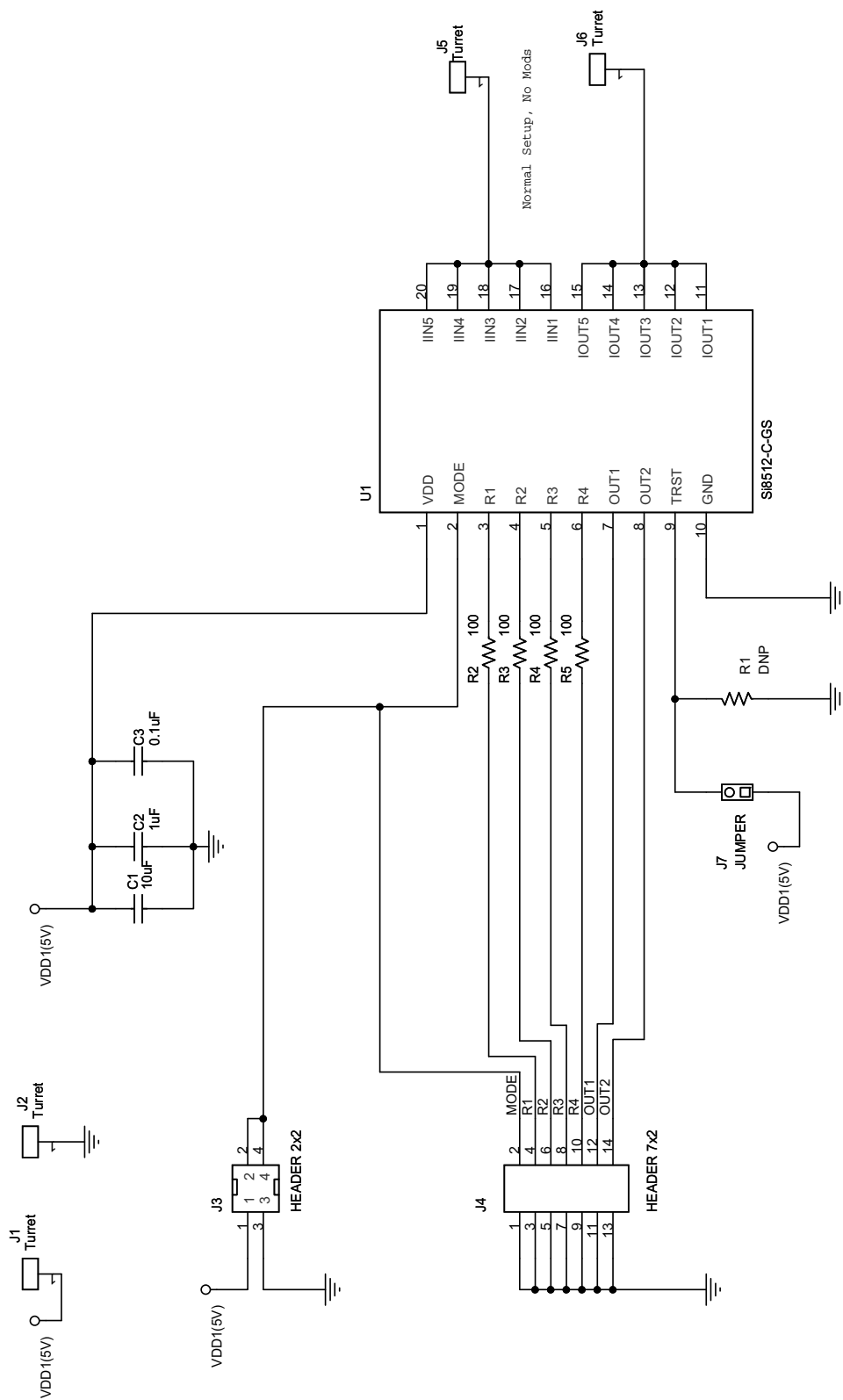

Figure 10. Si85xx5kV-TB Target Board Schematic (5 kV, 10 Amp Target Board)

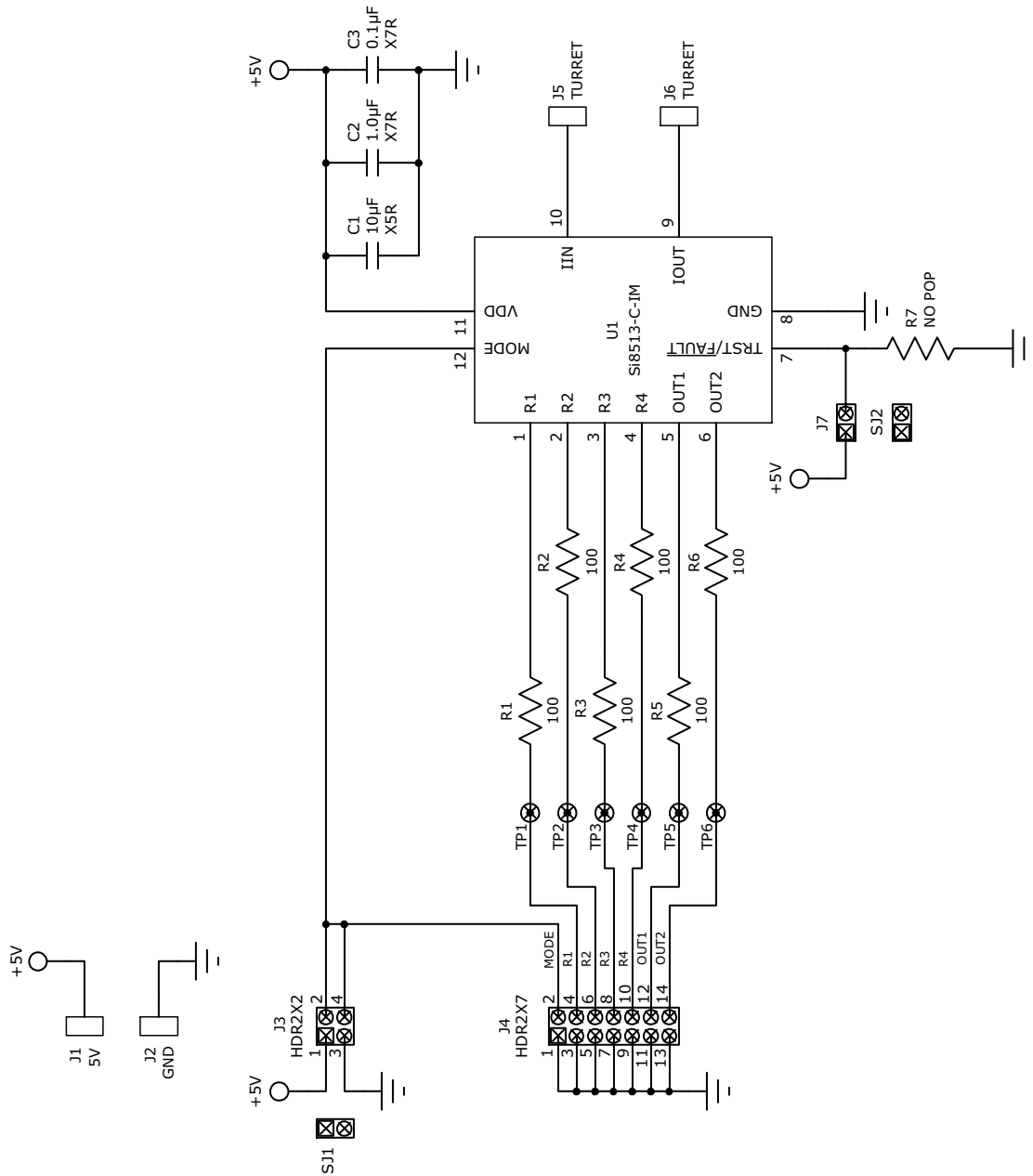

Figure 11. Si85xx20AQFN-TB Target Board Schematic (1 kV, 20 Amp Target Board)

# Si85xx Target Board User's Guide

## 7. Bill of Materials

**Table 7. Si85xx-TB Bill of Materials (1 kV, 10 Amp Target Board)**

Item	Qty	Reference	Description	Mfr Part Number	Manufacturer
1	1	C1	10 uF	PCC2182CT-ND	Digi-Key
2	1	C2	0.1 uF	PCC1812CT-ND	Digi-Key
3	1	J1	5 V	2551-2-00-44-00-00-07-0	Bisco
4	1	J2	GND	2551-2-00-44-00-00-07-0	Bisco
5	1	J3	HDR-2X2	S2012-02-ND	Digi-Key
6	1	J4	HDR-2X07	S2012-07-ND	Digi-Key
7	1	J5	IIN	2551-2-00-44-00-00-07-0	Bisco
8	1	J6	IIOUT	2551-2-00-44-00-00-07-0	Bisco
9	1	J7	HEADER	S1012-02-ND	Digi-Key
10	1	R1	DNP	P150CCT-ND	Digi-Key
11	1	U1	Si851x	Si8500-IS	Digi-Key

**Table 8. Si85xx5kV-TB Bill of Materials (5 kV, 10 Amp Target Board)**

Item	Qty	Reference	Description	Mfr Part Number	Manufacturer
1	1	C1	10 µF	C0805X5R6R3-106M	Venkel
2	1	C2	1 µF	C0805X7R160-105M	Venkel
3	1	C3	0.1 µF	C0805X7R160-104K	Venkel
4	4	J1, J2, J5, J6	Turret	2551-2-00-44-00-00-07-0	Mill-Max
5	1	J3	HEADER 2x2	TSW-102-07-T-D	Samtec
6	1	J4	HEADER 7x2	TSW-107-07-T-D	Samtec
7	1	J7	JUMPER	TSW-102-07-T-S	Samtec
8	1	R1	DNP	CR0805-8W-1002F	Venkel
9	4	R2, R3, R4, R5	100	CR0805-10W-1000F	Venkel
10	1	U1	Si8512-C-GS	Si8512-C-GS	SiLabs



# Si85xx Target Board User's Guide

Table 9. Si85xx20AQFN-TB Bill of Materials (1 kV, 20 Amp Target Board)

Item	Qty	Reference	Description	Mfr Part Number	Manufacturer
1	4	J1-2 J5-6	Turret	2551-200440000070-ND	Digikey
2	1	C3	0.1 $\mu$ F	399-1167-1-ND	Digikey
3	1	C2	1 $\mu$ F	445-1604-1-ND	Digikey
4	1	C1	10 $\mu$ F	C0805C106M9PACTU-ND	Digikey
5	1	J7	Stake header	S1011E-02-ND	Digikey
6	1	J3	Stake header	S2011E-02-ND	Digikey
7	1	J4	Stake header	S2011E-07-ND	Digikey
8	2	SJ1-2	Shorting jumper	S9000-ND	Digikey
9	6	R1-6	100 $\Omega$	RNCF20T9100FR-ND	Digikey
10	1	R7	No POP	No POP	Digikey
11	1	U1	Si8513	Si8513-C-IM	Silicon Labs
12	6	TP1-6	No POP	No POP	Digikey

# Si85xx Target Board User's Guide

---

## 8. Ordering Guide

**Table 10. Ordering Guide**

<b>Ordering Part #</b>	<b>Description/Contents</b>	<b>Isolation Rating</b>
Si85xx-EVB	Evaluation board with Si8512 (10 Amp) in QFN package	1 kV <sub>RMS</sub>
Si85xx5kV-EVB	Evaluation board with Si8512 (10 Amp) in SOIC package	5 kV <sub>RMS</sub>
Si85XX20AQFN-EVB	Evaluation board with Si8513 (20 Amp) in QFN package	1 kV <sub>RMS</sub>

## DOCUMENT CHANGE LIST

### Revision 0.1 to Revision 0.2

- Added Si85xx5kV-TB target board descriptive details throughout.
  - Added Figure 2 on page 1.
  - Added Figure 7 on page 3.
  - Updated Figure 9 title.
  - Added Figure 10 on page 6.
  - Updated Table 7, "Si85xx-TB Bill of Materials (1 kV, 10 Amp Target Board)," on page 8.
  - Added Table 8, "Si85xx5kV-TB Bill of Materials (5 kV, 10 Amp Target Board)," on page 8.
  - Added "8. Ordering Guide" on page 10.

### Revision 0.2 to Revision 0.3

- Added Si85xx20AQFN-TB target board descriptive details throughout.
  - Added Figure 3 on page 1.
  - Added Figure 8 on page 3.
  - Added Figure 10 on page 6.
  - Added Table 9, "Si85xx20AQFN-TB Bill of Materials (1 kV, 20 Amp Target Board)," on page 9.
  - Updated "8. Ordering Guide" on page 10.

### Revision 0.3 to Revision 0.4

- Updated "8. Ordering Guide" on page 10.

# Si85xx Target Board User's Guide

---

## CONTACT INFORMATION

### Silicon Laboratories Inc.

400 West Cesar Chavez  
Austin, TX 78701  
Tel: 1+(512) 416-8500  
Fax: 1+(512) 416-9669  
Toll Free: 1+(877) 444-3032

Please visit the Silicon Labs Technical Support web page:  
<https://www.silabs.com/support/pages/contacttechnicalsupport.aspx>  
and register to submit a technical support request.

The information in this document is believed to be accurate in all respects at the time of publication but is subject to change without notice. Silicon Laboratories assumes no responsibility for errors and omissions, and disclaims responsibility for any consequences resulting from the use of information included herein. Additionally, Silicon Laboratories assumes no responsibility for the functioning of undescribed features or parameters. Silicon Laboratories reserves the right to make changes without further notice. Silicon Laboratories makes no warranty, representation or guarantee regarding the suitability of its products for any particular purpose, nor does Silicon Laboratories assume any liability arising out of the application or use of any product or circuit, and specifically disclaims any and all liability, including without limitation consequential or incidental damages. Silicon Laboratories products are not designed, intended, or authorized for use in applications intended to support or sustain life, or for any other application in which the failure of the Silicon Laboratories product could create a situation where personal injury or death may occur. Should Buyer purchase or use Silicon Laboratories products for any such unintended or unauthorized application, Buyer shall indemnify and hold Silicon Laboratories harmless against all claims and damages. The sale of this product contains no licenses to Power-One's intellectual property. Contact Power-One, Inc. for appropriate licenses.

Silicon Laboratories and Silicon Labs are trademarks of Silicon Laboratories Inc.

Other products or brandnames mentioned herein are trademarks or registered trademarks of their respective holders.

Компания «Океан Электроники» предлагает заключение долгосрочных отношений при поставках импортных электронных компонентов на взаимовыгодных условиях!

Наши преимущества:

- Поставка оригинальных импортных электронных компонентов напрямую с производств Америки, Европы и Азии, а так же с крупнейших складов мира;
- Широкая линейка поставок активных и пассивных импортных электронных компонентов (более 30 млн. наименований);
- Поставка сложных, дефицитных, либо снятых с производства позиций;
- Оперативные сроки поставки под заказ (от 5 рабочих дней);
- Экспресс доставка в любую точку России;
- Помощь Конструкторского Отдела и консультации квалифицированных инженеров;
- Техническая поддержка проекта, помощь в подборе аналогов, поставка прототипов;
- Поставка электронных компонентов под контролем ВП;
- Система менеджмента качества сертифицирована по Международному стандарту ISO 9001;
- При необходимости вся продукция военного и аэрокосмического назначения проходит испытания и сертификацию в лаборатории (по согласованию с заказчиком);
- Поставка специализированных компонентов военного и аэрокосмического уровня качества (Xilinx, Altera, Analog Devices, Intersil, Interpoint, Microsemi, Actel, Aeroflex, Peregrine, VPT, Syfer, Eurofarad, Texas Instruments, MS Kennedy, Miteq, Cobham, E2V, MA-COM, Hittite, Mini-Circuits, General Dynamics и др.);

Компания «Океан Электроники» является официальным дистрибьютором и эксклюзивным представителем в России одного из крупнейших производителей разъемов военного и аэрокосмического назначения «JONHON», а так же официальным дистрибьютором и эксклюзивным представителем в России производителя высокотехнологичных и надежных решений для передачи СВЧ сигналов «FORSTAR».



## JONHON

«JONHON» (основан в 1970 г.)

Разъемы специального, военного и аэрокосмического назначения:

(Применяются в военной, авиационной, аэрокосмической, морской, железнодорожной, горно- и нефтедобывающей отраслях промышленности)

«FORSTAR» (основан в 1998 г.)

ВЧ соединители, коаксиальные кабели, кабельные сборки и микроволновые компоненты:

(Применяются в телекоммуникациях гражданского и специального назначения, в средствах связи, РЛС, а так же военной, авиационной и аэрокосмической отраслях промышленности).



Телефон: 8 (812) 309-75-97 (многоканальный)

Факс: 8 (812) 320-03-32

Электронная почта: [ocean@oceanchips.ru](mailto:ocean@oceanchips.ru)

Web: <http://oceanchips.ru/>

Адрес: 198099, г. Санкт-Петербург, ул. Калинина, д. 2, корп. 4, лит. А