

## High Voltage High Current Feed-Through Terminal Blocks

---

The new High Voltage Generation of high current feed-through terminal blocks is specially designed for the requirements of drive technology and power electronics.

In addition to the already familiar simple assembly, the outstanding feature of these terminal blocks is a high nominal voltage of 1000 V. For the conductor cross section range up to 10 mm<sup>2</sup>, there are the horizontal feed-through terminal blocks, HDFK 10-HV and the vertical version, HDFKV 10-HV.

The HDFKV 10-TWIN-HV with a conductor connection on both sides is used to loop through intermediate circuit voltages.

In addition to this, the HV range is rounded off by the molded variant.

The HDFK...-VP-HV terminal blocks are specially designed for the requirements of potted devices, such as filter modules, for example. They are an ideal supplement to the HDFK range for the cross section range of up to 10 mm<sup>2</sup>.

The external parts of the molded high current feed-through terminal blocks is identical to those of the standard HV versions.

On the inside of the device, however, there is a sealing plate as well as a sponge rubber seal that prevents the molding compound from leaking out. The connection here is soldered.



# High Current Feed-Through Terminal Blocks HDFK 10-HV





(IEC) [mm <sup>2</sup> ]	rigid solid	flexible stranded	AWG	I [A]	U [V]
Connection data	0.5-16	0.5-10	20-6	76	1000

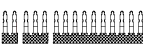

## Technical data

**Feed-through terminal block**, for 1 - 4 mm thick housing panels, with internal and external screw connection

(1) **Insertion bridge**<sup>1)</sup>, fully insul., 2-pos.   
 fully insulated, 3-pos.   
 divisible, fully insulated, 10-pos. 

(2) **Screwdriver**,  
for actuating the tension spring 

(3) **Zack strip**, 10-section, white 

### Dimensions

#### Technical data in accordance with IEC/ DIN VDE

Max. cross section with insertion bridge (solid/stranded)	[mm <sup>2</sup> ]
Rated surge voltage / contamination class	[kV] / -
Surge voltage category / insulation material group	- / -

#### Connection capacity

Stranded with ferrule without / with plastic sleeve	[mm <sup>2</sup> ]
---	--------------------

#### Multi-conductor connection (2 cond. with same cross section)

Solid / Stranded	[mm <sup>2</sup> ]
Stranded with ferrule without plastic sleeve	[mm <sup>2</sup> ]
Stranded with TWIN ferrule with plastic sleeve	[mm <sup>2</sup> ]

**Stripping length** [mm]

#### Internal cylindrical gauge (IEC 60 947-1)

**Terminal sleeve: Thread / torque** - / [Nm]

#### Insulating material

Inflammability class in acc. with UL 94

#### Approval data (UL and CSA/CUL)

Nominal voltage / current / conductor sizes	UL: [V] / [A] / AWG
	CSA/CUL: [V] / [A] / AWG

<sup>1)</sup> Finger-safe protection is not guaranteed when using the insertion bridge externally.

#### Note:

With the HDFK and HDFKV, the terminal space must be completely open when joining both terminal block halves.

The HDFK 10-HV can also be connected if turned by 180°.

Type	Order No.	Pcs. Pkt.
HDFK 10-HV	07 09 86 4	50
EB 2-10	I <sub>max</sub> : 70 A	100
EB 3-10		10
EB 10-10		10
SZS 1,0 x 4,0	12 05 06 6	10
ZB 10:UNPRINTED	10 53 00 1	10

see dimensional drawing

10 / 10
6 / 3
III / I
0.5 - 10 / 0.5 - 10
0.5 - 4 / 0.5 - 4
0.5 - 2.5
0.5 - 6
11
B 6
M 4 / 1.5 - 1.8
PA
V0
600 / 65 / 24 - 6
600 / 65 / 22 - 6

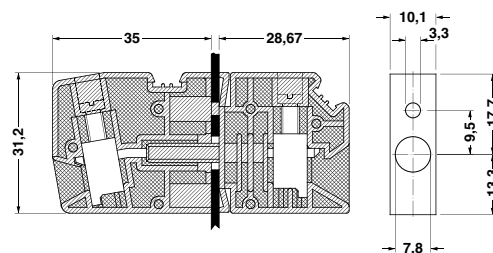

# High Current Feed-Through Terminal Blocks HDFKV 10-HV



(IEC) [mm <sup>2</sup> ]	rigid solid	flexible stranded	AWG	I [A]	U [V]
Connection data	0.5-16	0.5-10	20-6	76	1000

## Technical data

**Feed-through terminal block**, for 1 - 4 mm thick housing panels, with internal and external screw connection

(1) **Insertion bridge**<sup>1)</sup>, fully insul., 2-pos. fully insulated, 3-pos. divisible, fully insulated, 10-pos.

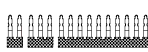

(2) **Screwdriver**, for actuating the tension spring

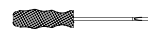

(3) **Zack strip**, 10-section,

white

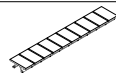

## Dimensions

### Technical data in accordance with IEC/ DIN VDE

Max. cross section with insertion bridge (solid/stranded)	[mm <sup>2</sup> ]	10 / 10
Rated surge voltage / contamination class	[kV] / -	6 / 3
Surge voltage category / insulation material group	- / -	III / I

### Connection capacity

Stranded with ferrule without / with plastic sleeve	[mm <sup>2</sup> ]	0.5 - 10 / 0.5 - 10
---	--------------------	---------------------

### Multi-conductor connection (2 cond. with same cross section)

Solid / Stranded	[mm <sup>2</sup> ]	0.5 - 4 / 0.5 - 4
Stranded with ferrule without plastic sleeve	[mm <sup>2</sup> ]	0.5 - 2.5
Stranded with TWIN ferrule with plastic sleeve	[mm <sup>2</sup> ]	0.5 - 6

**Stripping length** [mm] 11

### Internal cylindrical gauge (IEC 60 947-1)

**Terminal sleeve: Thread / torque** - / [Nm] B 6

### Insulating material

Inflammability class in acc. with UL 94 PA

### Approval data (UL and CSA/CUL)

Nominal voltage / current / conductor sizes UL/CUL: [V] / [A] / AWG V0 600 / 65 / 24 - 6

Type	Order No.	Pcs. Pkt.
HDFKV 10-HV	07 17 23 8	50
EB 2-10	I <sub>max</sub> : 70 A	100
EB 3-10		10
EB 10-10		10
SZS 1,0 x 4,0	12 05 06 6	10
ZB 10:UNPRINTED	10 53 00 1	10

see dimensional drawing

<sup>1)</sup> Finger-safe protection is not guaranteed when using the insertion bridge externally.

### Note:

With the HDFK and HDFKV, the terminal space must be completely open when joining both terminal block halves.

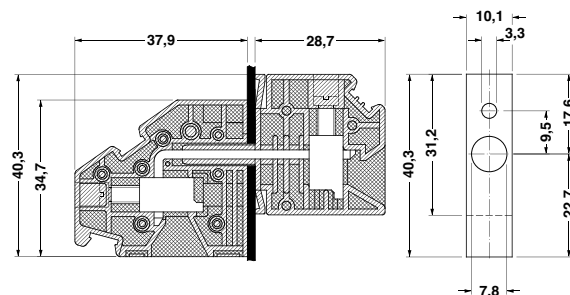

# High Current Feed-Through Terminal Blocks HDFKV 10-TWIN-HV

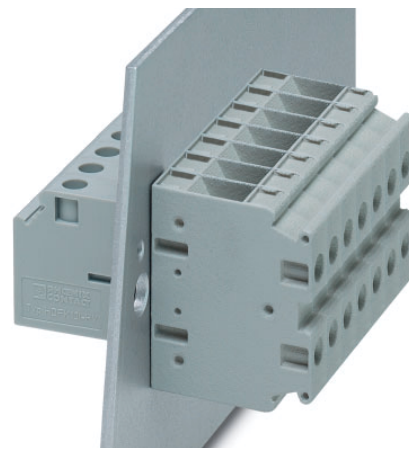



(IEC) [mm <sup>2</sup> ]	rigid solid	flexible stranded	AWG	I [A]	U [V]
Connection data	0.5-16	0.5-10	20-6	76*	1000

\* The max. load current must not be exceeded by the total current of all connected conductors.

## Technical data

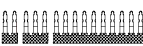
**Feed-through terminal block**, with internal and external screw connection, for 1 - 4 mm thick housing panels, external for vertical conductor connection

(1) **Insertion bridge**<sup>1)</sup>, fully insul., 2-pos.   
 fully insulated, 3-pos.   
 divisible, fully insulated, 10-pos. 

(2) **Screwdriver**, for actuating the tension spring 

(3) **Zack strip**, 10-section, white 

### Dimensions

#### Technical data in accordance with IEC/ DIN VDE

Max. cross section with insertion bridge (solid/stranded)	[mm <sup>2</sup> ]	10 / 10
Rated surge voltage / contamination class	[kV] / -	6 / 3
Surge voltage category / insulation material group	- / -	III / I

#### Connection capacity

Stranded with ferrule without / with plastic sleeve	[mm <sup>2</sup> ]	0.5 - 10 / 0.5 - 10
---	--------------------	---------------------

#### Multi-conductor connection (2 cond. with same cross section)

Solid / Stranded	[mm <sup>2</sup> ]	0.5 - 4 / 0.5 - 4
Stranded with ferrule without plastic sleeve	[mm <sup>2</sup> ]	0.5 - 2.5
Stranded with TWIN ferrule with plastic sleeve	[mm <sup>2</sup> ]	0.5 - 6

**Stripping length** [mm] 11

**Internal cylindrical gauge (IEC 60 947-1)** B 6

**Terminal sleeve: Thread / torque** M 4 / 1.5 - 1.8

**Insulating material** PA

Inflammability class in acc. with UL 94 V0

#### Approval data (UL and CSA/CUL)

Nominal voltage / current / conductor sizes UL/CUL: [V] / [A] / AWG 600 / 65 / 24 - 6

Type	Order No.	Pcs. Pkt.
<b>HDFKV 10-TWIN-HV</b>	<b>07 17 24 1</b>	<b>50</b>
<b>EB 2-10</b>	$I_{max}$ : 70 A <b>02 03 15 3</b>	<b>100</b>
<b>EB 3-10</b>	70 A <b>02 03 32 8</b>	<b>10</b>
<b>EB 10-10</b>	70 A <b>02 03 13 7</b>	<b>10</b>
<b>SZS 1,0 x 4,0</b>	<b>12 05 06 6</b>	<b>10</b>
<b>ZB 10:UNPRINTED</b>	<b>10 53 00 1</b>	<b>10</b>

see dimensional drawing

<sup>1)</sup> Finger-safe protection is not guaranteed when using the insertion bridge externally.

#### Note:

With the HDFK and HDFKV, the terminal space must be completely open when joining both terminal block halves.

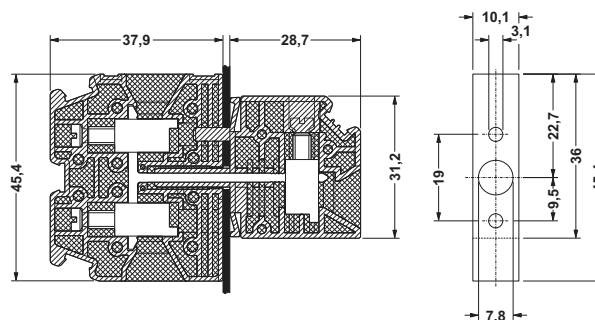



# High Current Feed-Through Terminal Blocks HDFK 10-VP-HV



(IEC) [mm <sup>2</sup> ]	rigid solid	flexible stranded	AWG	I [A]	U [V]
Connection data	0.5-16	0.5-10	20-6	76	1000

## Technical data

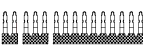
**Molded feed-through terminal block**, for 1 - 4 mm thick housing panels, with external screw connection, with solder connection and sealing plate inside

(1) **Insertion bridge**<sup>1)</sup>, fully insul., 2-pos.   
 fully insulated, 3-pos.   
 divisible, fully insulated, 10-pos. 

(2) **Screwdriver**,  
for actuating the tension spring 

(3) **Zack strip**, 10-section, white 

### Dimensions

#### Technical data in accordance with IEC/ DIN VDE

Max. cross section with insertion bridge (solid/stranded)	[mm <sup>2</sup> ]
Rated surge voltage / contamination class	[kV] / -
Surge voltage category / insulation material group	- / -

#### Connection capacity

Stranded with ferrule without / with plastic sleeve	[mm <sup>2</sup> ]
---	--------------------

#### Multi-conductor connection (2 cond. with same cross section)

Solid / Stranded	[mm <sup>2</sup> ]
Stranded with ferrule without plastic sleeve	[mm <sup>2</sup> ]
Stranded with TWIN ferrule with plastic sleeve	[mm <sup>2</sup> ]

**Stripping length** [mm]

#### Internal cylindrical gauge (IEC 60 947-1)

**Terminal sleeve: Thread / torque** - / [Nm]

#### Insulating material

Inflammability class in acc. with UL 94

<sup>1)</sup> Finger-safe protection is not guaranteed when using the insertion bridge externally.

Type	Order No.	Pcs. Pkt.
<b>HDFK 10-VP-HV</b>	<b>07 17 39 3</b>	<b>50</b>
<b>EB 2-10</b>	$I_{max}$ : 70 A <b>02 03 15 3</b>	<b>100</b>
<b>EB 3-10</b>	70 A <b>02 03 32 8</b>	<b>10</b>
<b>EB 10-10</b>	70 A <b>02 03 13 7</b>	<b>10</b>
<b>SZS 1,0 x 4,0</b>	<b>12 05 06 6</b>	<b>10</b>
<b>ZB 10:UNPRINTED</b>	<b>10 53 00 1</b>	<b>10</b>

see dimensional drawing

10 / 10
6 / 3
III / I
0.5 - 10 / 0.5 - 10
0.5 - 4 / 0.5 - 4
0.5 - 2.5
0.5 - 6
11
B 6
M 4 / 1.5 - 1.8
PA
V0

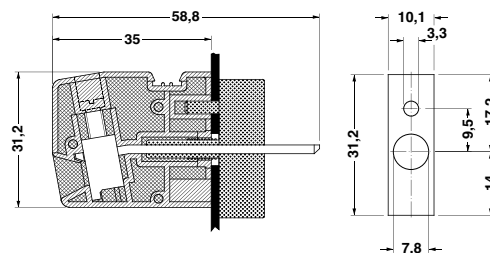

# High Current Feed-Through Terminal Blocks

## HDFKV 10-VP-HV



(IEC) [mm <sup>2</sup> ]	rigid solid	flexible stranded	AWG	I [A]	U [V]
Connection data	0.5-16	0.5-10	20-6	76	1000

### Technical data

**Molded Feed-through terminal block**, for 1 - 4 mm thick housing panels, with external screw connection, with solder connection and sealing plate inside

(1) **Insertion bridge**<sup>1)</sup>, fully insul., 2-pos. fully insulated, 3-pos. divisible, fully insulated, 10-pos.

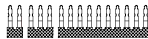

(2) **Screwdriver**, for actuating the tension spring



(3) **Zack strip**, 10-section, white

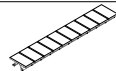

### Dimensions

#### Technical data in accordance with IEC/ DIN VDE

Max. cross section with insertion bridge (solid/stranded)	[mm <sup>2</sup> ]
Rated surge voltage / contamination class	[kV] / -
Surge voltage category / insulation material group	- / -

#### Connection capacity

Stranded with ferrule without / with plastic sleeve	[mm <sup>2</sup> ]
---	--------------------

#### Multi-conductor connection (2 cond. with same cross section)

Solid / Stranded	[mm <sup>2</sup> ]
Stranded with ferrule without plastic sleeve	[mm <sup>2</sup> ]
Stranded with TWIN ferrule with plastic sleeve	[mm <sup>2</sup> ]

**Stripping length** [mm]

**Internal cylindrical gauge (IEC 60 947-1)**

**Terminal sleeve: Thread / torque** - / [Nm]

#### Insulating material

Inflammability class in acc. with UL 94

#### Approval data (UL and CSA/CUL)

Nominal voltage / current / conductor sizes UL/CUL: [V] / [A] / AWG

Type	Order No.	Pcs. Pkt.
HDFKV 10-VP-HV	07 17 25 4	50
EB 2-10	I <sub>max</sub> : 70 A	100
EB 3-10		10
EB 10-10		10
SZS 1,0 x 4,0	12 05 06 6	10
ZB 10:UNPRINTED	10 53 00 1	10

see dimensional drawing

10 / 10
6 / 3
III / I
0.5 - 10 / 0.5 - 10
0.5 - 4 / 0.5 - 4
0.5 - 2.5
0.5 - 6
11
B 6
M 4 / 1.5 - 1.8
PA
V0
600 / 65 / 24 - 6

<sup>1)</sup> Finger-safe protection is not guaranteed when using the insertion bridge externally.

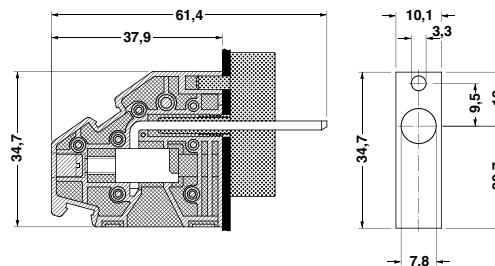

Компания «Океан Электроники» предлагает заключение долгосрочных отношений при поставках импортных электронных компонентов на взаимовыгодных условиях!

Наши преимущества:

- Поставка оригинальных импортных электронных компонентов напрямую с производств Америки, Европы и Азии, а так же с крупнейших складов мира;
- Широкая линейка поставок активных и пассивных импортных электронных компонентов (более 30 млн. наименований);
- Поставка сложных, дефицитных, либо снятых с производства позиций;
- Оперативные сроки поставки под заказ (от 5 рабочих дней);
- Экспресс доставка в любую точку России;
- Помощь Конструкторского Отдела и консультации квалифицированных инженеров;
- Техническая поддержка проекта, помощь в подборе аналогов, поставка прототипов;
- Поставка электронных компонентов под контролем ВП;
- Система менеджмента качества сертифицирована по Международному стандарту ISO 9001;
- При необходимости вся продукция военного и аэрокосмического назначения проходит испытания и сертификацию в лаборатории (по согласованию с заказчиком);
- Поставка специализированных компонентов военного и аэрокосмического уровня качества (Xilinx, Altera, Analog Devices, Intersil, Interpoint, Microsemi, Actel, Aeroflex, Peregrine, VPT, Syfer, Eurofarad, Texas Instruments, MS Kennedy, Miteq, Cobham, E2V, MA-COM, Hittite, Mini-Circuits, General Dynamics и др.);

Компания «Океан Электроники» является официальным дистрибьютором и эксклюзивным представителем в России одного из крупнейших производителей разъемов военного и аэрокосмического назначения «**JONHON**», а так же официальным дистрибьютором и эксклюзивным представителем в России производителя высокотехнологичных и надежных решений для передачи СВЧ сигналов «**FORSTAR**».



**JONHON**

«**JONHON**» (основан в 1970 г.)

Разъемы специального, военного и аэрокосмического назначения:

(Применяются в военной, авиационной, аэрокосмической, морской, железнодорожной, горно- и нефтедобывающей отраслях промышленности)

«**FORSTAR**» (основан в 1998 г.)

ВЧ соединители, коаксиальные кабели, кабельные сборки и микроволновые компоненты:

(Применяются в телекоммуникациях гражданского и специального назначения, в средствах связи, РЛС, а так же военной, авиационной и аэрокосмической отраслях промышленности).



Телефон: 8 (812) 309-75-97 (многоканальный)

Факс: 8 (812) 320-03-32

Электронная почта: [ocean@oceanchips.ru](mailto:ocean@oceanchips.ru)

Web: <http://oceanchips.ru/>

Адрес: 198099, г. Санкт-Петербург, ул. Калинина, д. 2, корп. 4, лит. А