

# LT1370 6A Switch

## 2.7V to 12V Input

## 5V or 12V Output

### DESCRIPTION

Demonstration board DC185 is a complete DC/DC step-down regulator using the LT<sup>®</sup>1370 constant frequency, high efficiency converter in a 7-pin DD package. High

frequency switching allows the use of small inductors, making this all surface mount solution ideal for space-conscious systems.

LT, LTC and LT are registered trademarks of Linear Technology Corporation.

### PERFORMANCE SUMMARY

$T_A = 25^\circ\text{C}$ ,  $V_{IN} = 5\text{V}$ ,  $I_{LOAD} = 1\text{A}$ ,  $V_{OUT} = 12\text{V}$  (jumper J1 removed), S/D pin open, unless otherwise specified.

PARAMETER	CONDITIONS	MIN	TYP	MAX	UNITS
Output Voltage	Jumper J1 Removed (Note 1)	11.6	12.0	12.4	V
	Jumper J1 Inserted	4.85	5.00	5.17	V
Maximum $I_{SW}$		6	8	10	A
Input Voltage Range	(Note 2)	2.7		12	V
Switching Frequency		440	500	580	kHz
Output Ripple Voltage			80		mV <sub>p-p</sub>
Line Regulation	$V_{IN} = 2.7\text{V to }11\text{V}$ , $I_{LOAD} = 0.5\text{A}$		20		mV
Load Regulation	$I_{LOAD} = 10\text{mA to }1.75\text{A}$		18		mV
S/D Shutdown Threshold		0.6	1.3	2	V
S/D Synchronization Range		600		800	kHz
Supply Current	S/D = 0V, $I_{LOAD} = 0\text{A}$ (Note 3)		100		$\mu\text{A}$

**Note 1:** Output voltage variations include  $\pm 1\%$  tolerance of feedback divider network. For tighter voltage range, use lower tolerance resistors.

**Note 2:** With the boost topology, input voltage must always be lower than output voltage. See the LT1370 data sheet for maximum device ratings.

**Note 3:** The boost topology provides a path from input to output even with the LT1370 in shutdown. Applications are available that remove this direct path and reduce shutdown supply current to  $12\mu\text{A}$ , independent of loading.

### TYPICAL PERFORMANCE CHARACTERISTICS AND BOARD PHOTO

Output Efficiency

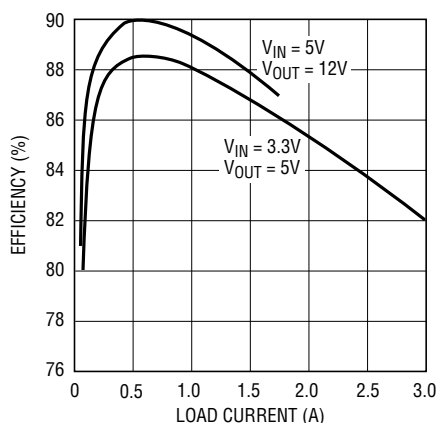

DM185 G01

Maximum Load Current vs Input Voltage

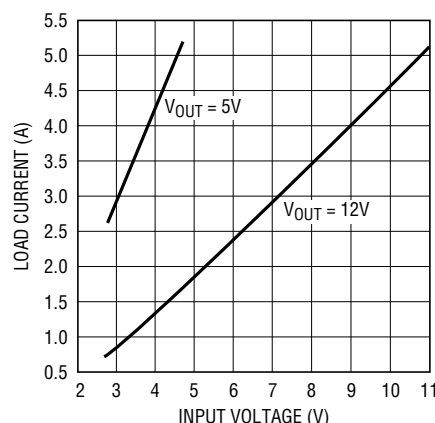

DM185 G02

Component Side



DC185 BP

## PACKAGE A MD SCHEMATIC DIAGRAMS

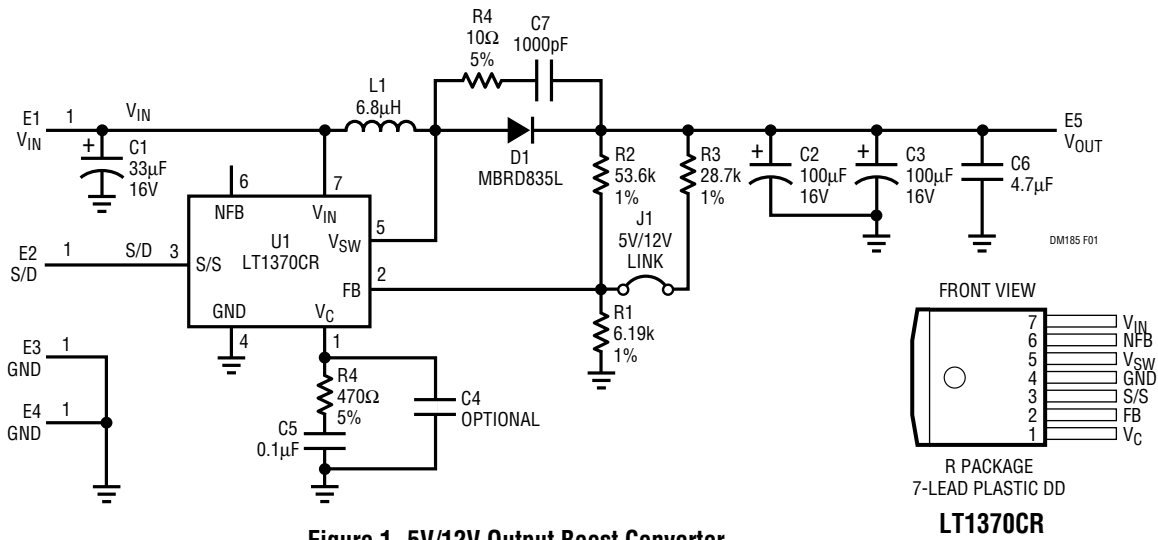

Figure 1. 5V/12V Output Boost Converter

## PARTS LIST

REFERENCE DESIGNATOR	QUANTITY	PART NUMBER	DESCRIPTION	VENDOR	TELEPHONE
C1	1	T495D336M016AS	33µF 16V Tantalum Capacitor, Case-D	Kemet	(714) 640-9320
C2, C3	2	T495X107M016AS	100µF 16V Tantalum Capacitor, Case-D	Kemet	(714) 640-9320
C4	1	Optional			
C5	1	08055C104MAT3S	0.1µF 50V X7R Chip Capacitor, 0805	AVX	(803) 946-0362
C6	1	1206YG475MAT3S	4.7µF 16V Y5V Chip Capacitor, 1206	AVX	(803) 946-0362
C7	1	08053A102KAT	1000pF, 25V NPO Chip Capacitor, 0805	AVX	(803) 946-0362
D1	1	MBRD835L	SMT Diode, D-Pak	Motorola	(602) 244-3576
E1 to E5	5	2501-2	Pad Turret, PAD.092	Mill-Max	(516) 922-6000
R1	1	CR10-6191F-T	6.19k 1/8W 1% Chip Resistor, 0805	TAD	(800) 508-1521
R2	1	CR10-5362F-T	53.6k 1/8W 1% Chip Resistor, 0805	TAD	(800) 508-1521
R3	1	CR10-2872F-T	28.7k 1/8W 1% Chip Resistor, 0805	TAD	(800) 508-1521
R4	1	CT10-471J-T	470Ω 1/8W 5% Chip Resistor, 0805	TAD	(800) 508-1521
R5	1	CR10-100J-T	10Ω 1/8W 5% Chip Resistor, 0805	TAD	(800) 508-1521
L1	1	501-0726	6.8µH 20% Inductor, Qtr-Pak	BH-Elec	(612) 894-9590
J1	1	2802S-02-G2	0.079" Center 2-Pin Header	Comm Con	(818) 301-4200
J1	1	CCIJ2MM-138-G	0.079" Center 2-Pin Shunt	Comm Con	(818) 301-4200
U1	1	LT1370CR	7-Lead DD IC	LTC	(408) 432-1900

## OPERATION

### DC185 Operation

The DC185 demonstration board is intended for evaluating the LT1370 switching regulator in a typical step-up application. Solid turret terminals are provided for easy connection to test equipment. A device pinout and board schematic are shown in Figure 1. Please refer to the

LT1370 data sheet for additional specifications and applications information. You may find Linear Technology's SwitcherCAD™ software helpful for creating your own designs.

SwitcherCAD is a trademark of Linear Technology Corporation.

## OPERATION

### Hook-Up

Connect the input supply and measurement instruments to the  $V_{IN}$  and GND terminals. The S/D pin (synchronization/shutdown) can be connected to  $V_{IN}$  or left open. Connect the output load and measurement instruments to the  $V_{OUT}$  and GND terminals.

### LT1370 Operation

The LT1370 is a monolithic, high frequency, current mode switcher. The part can operate from an input supply range of 2.7V to 30V (DC185 maximum  $V_{IN} = 12V$ ) and draws only 4.5mA quiescent current. The on-chip current limited power switch is guaranteed to 6A minimum switch current with a  $0.065\Omega$  typical “on” resistance and a 35V minimum breakdown voltage. The switch, which operates at a fixed frequency of 500kHz, can also be easily synchronized to a higher frequency by driving the S/D pin with a logic-level source. Shutdown is activated by holding the S/D pin below 0.6V, which reduces device supply current to 40 $\mu$ A maximum.

Under normal operating conditions, a 1.245V reference voltage is developed at the Feedback pin. The output voltage is set by R1 and R2, where  $V_{OUT} = V_{REF} (1 + R2/R1)$ . Although not used in this application, the part also has a Negative Feedback pin (NFB), which can be used to set the output voltage of positive-to-negative converters. When in use, a  $-2.48V$  reference voltage is developed at the NFB pin.

The  $V_C$  pin is the output of the error amplifier. During normal regulator operation, this pin sits at a voltage between 1V (low output current) and 1.9V (high output current). Loop frequency compensation is performed at the  $V_C$  pin via an RC network to ground.

## COMPONENTS

### Inductor

The inductor is a BH Electronics 501-0726, a 6.8 $\mu$ H toroidal ferrite unit. It was selected for its small size, low EMI, low DCR and 5A  $I_{SAT}$  rating.

### Capacitors (and Input/Output Ripple Voltage)

The capacitors on this board are low ESR (effective series resistance) tantalum units specifically designed for switch

mode power supply applications. At these high frequencies, input and output ripple voltages are more a function of the ESR of the capacitor than of the capacitance value. For example, at 500kHz a 100 $\mu$ F capacitor has a capacitive reactance of only  $0.003\Omega$ , which is much lower than the limiting  $0.1\Omega$  maximum ESR of the capacitors used. Therefore, if a reduction in input or output ripple voltage is required, use two or more capacitors in parallel instead of a larger value capacitor. If very low output ripple voltage is needed, adding an output LC filter may be a cheaper solution. The output contains very narrow voltage spikes because of the parasitic inductance of the output capacitor. Due to their high frequency nature, the amplitude of the spikes is determined by the ESL (effective series inductance) of the output capacitor. But this also makes them easy to filter. Small 0.1 $\mu$ F ceramic chip capacitors work well in reducing the spikes. If trace connections to the load are a few inches or more in length, the parasitic inductance, combined with any local load bypass capacitor, will virtually eliminate the spikes at the load.

### Snubber

R4 and C7 form a snubber network across the catch diode, D1. This reduces the spikes seen on the output due to ringing of the catch diode on switching edges. The snubber reduces efficiency typically by 0.5%. Trace inductance and decoupling capacitors on the application board may remove the need for a snubber network.

### Diodes

Use diodes designed for switching applications, with adequate current rating and fast turn-on times, such as Schottky or ultrafast diodes. In selecting a diode, the basic parameters of interest are forward voltage, maximum reverse voltage, average operating current and peak current. Lower forward voltage yields higher circuit efficiency and lower power dissipation in the diode. The worst-case reverse voltage is equal to the output voltage. The average diode current will be equal to the output current, but the peak diode current can be many times higher than the output current. Except for output short-circuit conditions, peak diode current is limited to the switch current limit of 7.5A maximum.

## OPERATION

### Thermal Considerations

Care should be taken to ensure that the worst-case input voltage and load current conditions do not cause excessive die temperatures. Please consult the LT1370 data sheet or Linear Technology's SwitcherCAD software for more information.

### PCB Layout

In many cases, the circuit area traces of the demonstration board may be dropped directly into your PCB layout. If not,

there are a few things to be aware of with high frequency converter layouts. Keep the traces connecting the Switch (Pin 5), output diode, output capacitor and ground return path (Pin 4 and Tab) as short as possible. This will reduce RFI and limit the voltage spikes caused by parasitic inductance. Keep the more sensitive components, mainly the feedback resistors and  $V_C$  pin network, away from the high current switching components.

## PCB LAYOUT AND FILM

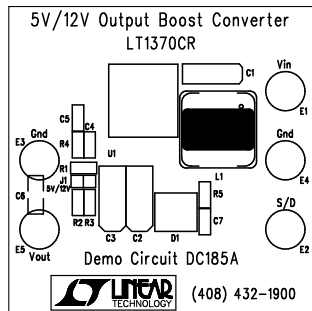

Silkscreen Top

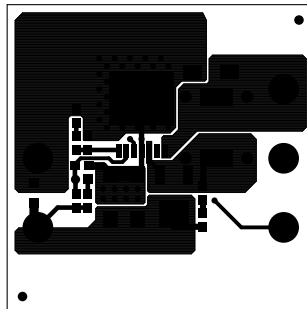

Component Side

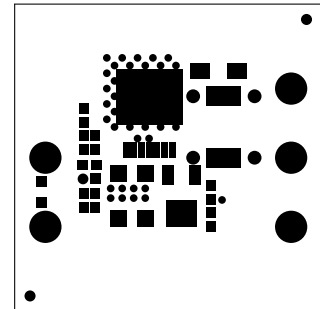

Solder Mask Top

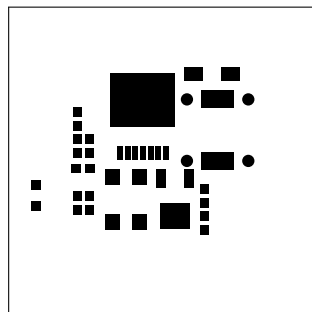

Paste Mask Top

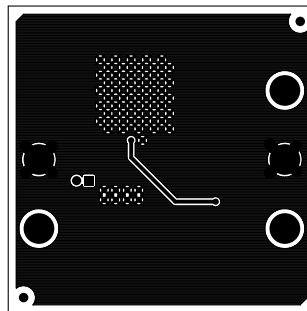

Solder Side

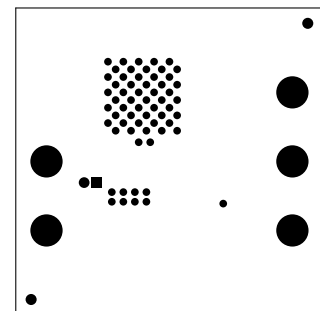

Solder Mask Bottom

## PC FAB DRAWING

SYMBOL	DIAMETER	# OF HOLES	PLATED
A	0.020	58	Yes
B	0.037	2	Yes
C	0.025	3	Yes
D	0.072	2	No
E	0.095	5	Yes
TOTAL HOLES		70	

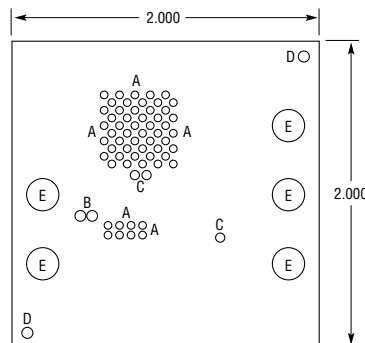

NOTES: UNLESS OTHERWISE SPECIFIED

- MATERIAL: FR4 OR EQUIVALENT EPOXY, 2 OZ COPPER CLAD THICKNESS  $0.062 \pm 0.006$  TOTAL OF 2 LAYERS
- FINISH: ALL PLATED HOLES 0.001 MIN/0.0015 MAX COPPER PLATE ELECTRODEPOSITED TIN-LEAD COMPOSITION BEFORE REFLOW, SOLDER MASK OVER BARE COPPER (SMOBC)
- SOLDER MASK: BOTH SIDES USING GREEN PC-401 OR EQUIVALENT
- SILKSCREEN: USING WHITE NONCONDUCTIVE EPOXY INK
- ALL DIMENSIONS ARE IN INCHES

Компания «Океан Электроники» предлагает заключение долгосрочных отношений при поставках импортных электронных компонентов на взаимовыгодных условиях!

Наши преимущества:

- Поставка оригинальных импортных электронных компонентов напрямую с производств Америки, Европы и Азии, а так же с крупнейших складов мира;
- Широкая линейка поставок активных и пассивных импортных электронных компонентов (более 30 млн. наименований);
- Поставка сложных, дефицитных, либо снятых с производства позиций;
- Оперативные сроки поставки под заказ (от 5 рабочих дней);
- Экспресс доставка в любую точку России;
- Помощь Конструкторского Отдела и консультации квалифицированных инженеров;
- Техническая поддержка проекта, помощь в подборе аналогов, поставка прототипов;
- Поставка электронных компонентов под контролем ВП;
- Система менеджмента качества сертифицирована по Международному стандарту ISO 9001;
- При необходимости вся продукция военного и аэрокосмического назначения проходит испытания и сертификацию в лаборатории (по согласованию с заказчиком);
- Поставка специализированных компонентов военного и аэрокосмического уровня качества (Xilinx, Altera, Analog Devices, Intersil, Interpoint, Microsemi, Actel, Aeroflex, Peregrine, VPT, Syfer, Eurofarad, Texas Instruments, MS Kennedy, Miteq, Cobham, E2V, MA-COM, Hittite, Mini-Circuits, General Dynamics и др.);

Компания «Океан Электроники» является официальным дистрибьютором и эксклюзивным представителем в России одного из крупнейших производителей разъемов военного и аэрокосмического назначения «**JONHON**», а так же официальным дистрибьютором и эксклюзивным представителем в России производителя высокотехнологичных и надежных решений для передачи СВЧ сигналов «**FORSTAR**».



## JONHON

«**JONHON**» (основан в 1970 г.)

Разъемы специального, военного и аэрокосмического назначения:

(Применяются в военной, авиационной, аэрокосмической, морской, железнодорожной, горно- и нефтедобывающей отраслях промышленности)

«**FORSTAR**» (основан в 1998 г.)

ВЧ соединители, коаксиальные кабели,  
кабельные сборки и микроволновые компоненты:

(Применяются в телекоммуникациях гражданского и специального назначения, в средствах связи, РЛС, а так же военной, авиационной и аэрокосмической отраслях промышленности).



Телефон: 8 (812) 309-75-97 (многоканальный)

Факс: 8 (812) 320-03-32

Электронная почта: [ocean@oceanchips.ru](mailto:ocean@oceanchips.ru)

Web: <http://oceanchips.ru/>

Адрес: 198099, г. Санкт-Петербург, ул. Калинина, д. 2, корп. 4, лит. А