

**INDUSTRIAL@AMPHENOL**  
TRUSTED GLOBALLY

Amphenol Sine Systems

# Motion | Grade™

Connectors & Cables



**M23 and M40 CONNECTORS**  
featuring FlexGrip™ and RockSolid™ Technology

**INTERCONNECTING YOUR WORLD**

# MotionGrade™ M23 and M40 Connectors

Amphenol Sine Systems MotionGrade™ M23 and M40 Connector Systems are designed to excel in performance and reliability in our customers' most demanding environments. Our innovations and experience as an industry leader in connector technology and total interconnect solutions allow us to offer such features as our FlexGrip™ Backshell System and RockSolid™ Contacts. These and other features combined with a simplistic design approach reduce initial procurement and assembly cost, while ensuring compatibility to all other existing standard layouts. Amphenol's MotionGrade™ M23 and M40 products are ideally suited for advanced servo drive encoder feedback applications, packaging, robotic, printing, machine tool, medical and automation environments where control signal transmission or power are required in a robust and compact delivery system.

TECHNICAL DATA	M23 A Series	M23 B SERIES	M40 C SERIES
TEMPERATURE RANGE	-20°C to +130°C	-20°C to +130°C	-20°C to +130°C
PROTECTION	IP 67 (Plugged condition)	IP 67 (Plugged condition)	IP 67 (Plugged condition)
DATA ACCORDING TO UL 840	M23 A Series	M23 B SERIES	M40 C SERIES
DEGREE OF PROTECTION	3	3	3
OVER VOLTAGE CATEGORY	III	III	III
MATERIALS	M23 A Series	M23 B SERIES	M40 C SERIES
HOUSING BODY	Zinc Die-cast	Zinc Die-cast	Zinc Die-cast
COUPLING NUT	Brass, Nickel-plated	Brass, Nickel-plated	Brass, Nickel-plated
INSULATION INSERTS	PA66, UL 94 / V0	PA66, UL 94 / V0	PA66 / PBT, UL 94 / V0
CONTACTS	Brass, Gold-plated	Brass, Gold-plated	Brass, Gold-plated
SEALS	DuPont Viton®	DuPont Viton®	DuPont Viton®
ELECTRICAL DATA	M23 A Series 12 CONTACT CONNECTOR	M23 B SERIES POWER CONTACTS	M40 C SERIES POWER CONTACTS
MAX. CURRENT (MAX. WIRE GAUGE)	Max. 10A	Max. 28A (6 contacts) Max. 30A (8 & 9 contacts)	Max. 75A
MAXIMUM VOLTAGE	160V AC/DC	630V AC/DC	630V AC/DC
CONTACT RESISTENCE	< 5 mΩ	< 3 mΩ	< 1 mΩ
TEST VOLTAGE (BETWEEN CONTACTS)	2500V	6000V	6000V
MINIMUM MATING CYCLES	> 50	> 50	> 50
	M23 A Series 17 CONTACT CONNECTOR	M23 B SERIES SIGNAL CONTACTS (8-, 9 CONTACTS)	M40 C SERIES SIGNAL CONTACTS
MAX. CURRENT (MAX. WIRE GAUGE)	Max. 9A	Max. 10A	Max. 30A
TEST VOLTAGE (BETWEEN CONTACTS)	2500V	2500V	4000V
MAXIMUM VOLTAGE	125V AC/DC	250V AC/DC	250V AC/DC
CONTACT RESISTENCE	< 5 mΩ	< 5 mΩ	< 3 mΩ
MINIMUM MATING CYCLES	> 50	> 50	> 50

# Features and Benefits

FEATURES	BENEFITS
LOWEST INSTALLED COST	By providing enhanced performance and advancements to existing standard systems with improvements such as our FlexGrip™ design, these cost conscious innovations will increase the reliability & performance of one of the most dependable interconnect offerings available today.
SUPERIOR SHIELDING	First quality components coupled with a simplistic design provide maximum EMI/RFI shielding capabilities while reducing assembly preparation times.
ASSEMBLY/DISASSEMBLY	Overall design construction allows for one step process of contact extraction versus complete connector disassembly found within other brands. An integrated contact locking system ensures ease of use and definitive contact integrity upon insertion.
CABLE STRAIN RELIEF	Your choice of either the innovative design features of FlexGrip™ or traditional cable strain relieving similar to existing standard systems.
FLUID RESISTANCE and SEALING	In combination with our strain relief systems, Amphenol utilizes advanced sealing technologies & materials to ensure highest reliability when subjected to the harshest environments.
CONTACTS	By creating a 360 degree mating surface around the pin, Amphenol's RockSolid™ contact offering ensures longer contact life, lower contact resistance, immunizes against shock and vibration all while maintaining low insertion and extraction forces. Additionally, industry standard contacts are also available made with gold plated surfaces and high quality CuZn alloys.
ROHS COMPLIANT	 All materials meet the requirements of the European Directive 2002/95/EC, Issue 13.2.2003.
ADD'L APPROVALS	  ISO 9001/2000



# Insert Arrangements

Contact Size Legend		
		

M23 A Series (Face view: CW - clockwise, CCW - counter clockwise)

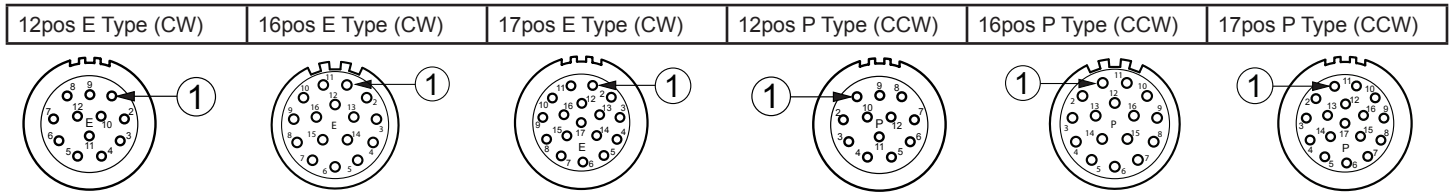

M23 B Series (Face view of socket insert)



M40 C Series (Face view of socket insert)

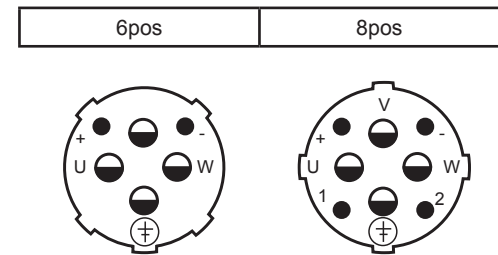

## Coding Keys

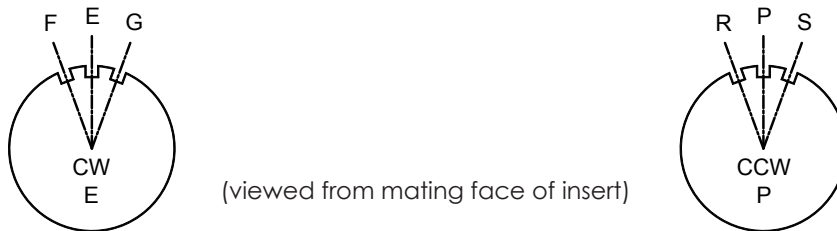

### ALL M23 A SERIES INSERTS COME WITH 3 CODING KEYS.

To order the connector with the correct insert coding, change the 6th digit in the catalog part number per the coding letter desired (see figure above).

Examples:

MA1CAE1200 for "E" coding, MA1CAF1200 for "F" coding, MA1CAG1200 for "G" coding  
 MA1CAP1200 for "P" coding, MA1CAR1200 for "R" coding, MA1CAS1200 for "S" coding

If you are ordering an "E" type connector, coding options are only: E, F & G. Normal coding is identified as "E".  
 If you are ordering a "P" type connector, coding options are only: P, R & S. Normal coding is identified as "P".

# M23 Signal Solutions - A Series

Contact Size Legend	
● 2.0mm	○ 1.0mm

M23 A Series (Face view: CW - clockwise, CCW - counter clockwise)

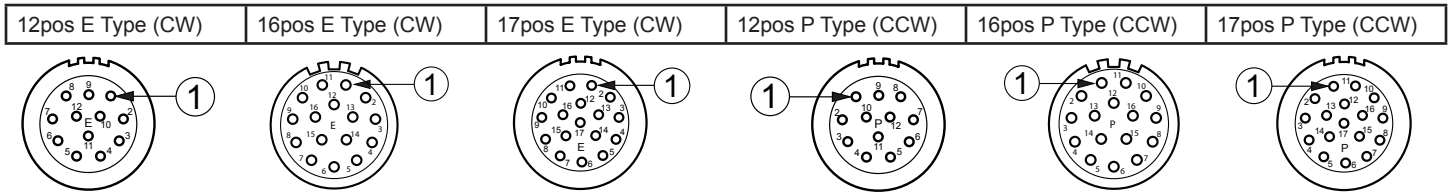

## Plugs (Less contacts)

TYPE	12E	12P	16E	16P	17E	17P
P/N	MA1CAE1200	MA1CAP1200	MA1CAE1600	MA1CAP1600	MA1CAE1700	MA1CAP1700

## Rotatable 90° Plugs (Less contacts)

TYPE	12E	12P	16E	16P	17E	17P
P/N	MA1EAE1200	MA1EAP1200	MA1EAE1600	MA1EAP1600	MA1EAE1700	MA1EAP1700

## Straight Receptacles (Less contacts)

TYPE	12E	12P	16E	16P	17E	17P
P/N	MA1LAE1200	MA1LAP1200	MA1LAE1600	MA1LAP1600	MA1LAE1700	MA1LAP1700

## Rotatable 90° Receptacles (Less contacts)

TYPE	12E	12P	16E	16P	17E	17P
P/N	MA1RAE1201	MA1RAP1201	MA1RAE1601	MA1RAP1601	MA1RAE1701	MA1RAP1701

## Pins

## Sockets

<b>PART NUMBER</b>	<b>PART NUMBER</b>	
SC000035	SC000013	SC000044
<b>CONTACT SIZE</b>	<b>CONTACT SIZE</b>	
1.0mm	1.0mm	1.0mm
<b>TYPE</b>	<b>TYPE</b>	
Machined	RockSolid™	Slit Machined
<b>CRIMP BARREL (MAX)</b>	<b>CRIMP BARREL (MAX)</b>	
1.0mm <sup>2</sup> (18 GA)	1.0mm <sup>2</sup> (18 GA)	1.0mm <sup>2</sup> (18 GA)
<b>EXTRACTION TOOL</b>	<b>EXTRACTION TOOL</b>	
50-54931-1	50-54931-1	50-54931-1

## Extensions (Less contacts)

TYPE	12E	12P	16E	16P	17E	17P
P/N	MA1JAE1200	MA1JAP1200	MA1JAE1600	MA1JAP1600	MA1JAE1700	MA1JAP1700

- Plugs, Receptacles & Extensions accept Pins or Sockets
- For information on RockSolid™, please refer to page 2

# M23 Power Solutions - B Series

Contact Size Legend	
● 2.0mm	○ 1.0mm

## M23 B Series (Face view of socket insert)



### Plugs (Less contacts)

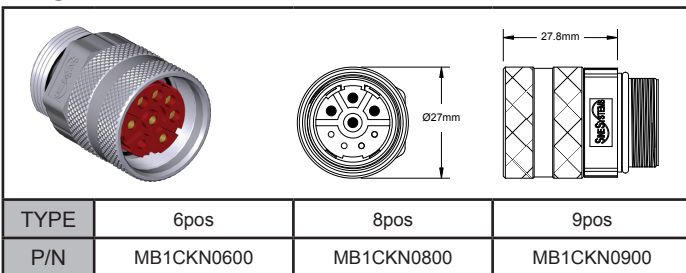

### Rotatable 90° Plugs (Less contacts)

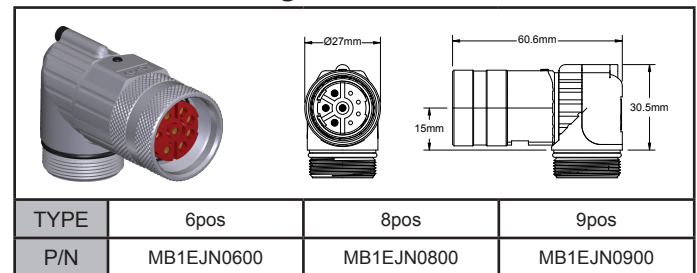

### Straight Receptacles (Less contacts)

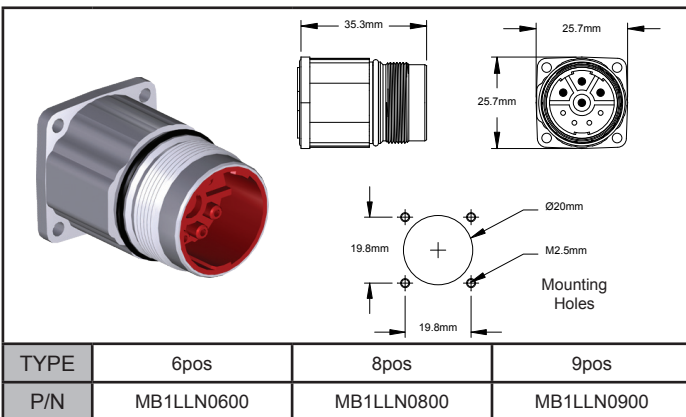

### Rotatable 90° Receptacles (Less contacts)

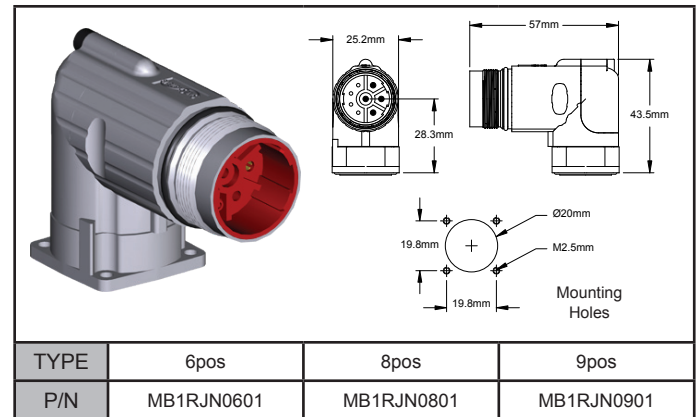

### Pins

### Sockets

PART NUMBER		PART NUMBER			
SC000035	SC000036	SC000013	SC000044	SC000014	SC000045
CONTACT SIZE		CONTACT SIZE			
1.0mm	2.0mm	1.0mm	1.0mm	2.0mm	2.0mm
TYPE		TYPE			
Machined	Machined	RockSolid™	Slit Machined	RockSolid™	Slit Machined
CRIMP BARREL (MAX)		CRIMP BARREL (MAX)			
1.0mm <sup>2</sup> (18 GA)	2.5mm <sup>2</sup> (14 GA)	1.0mm <sup>2</sup> (18 GA)	1.0mm <sup>2</sup> (18 GA)	2.5mm <sup>2</sup> (14 GA)	2.5mm <sup>2</sup> (14 GA)
EXTRACTION TOOL		EXTRACTION TOOL			
50-54931-1	50-54931-2	50-54931-1	50-54931-1	50-54931-2	50-54931-2

### Extensions (Less contacts)

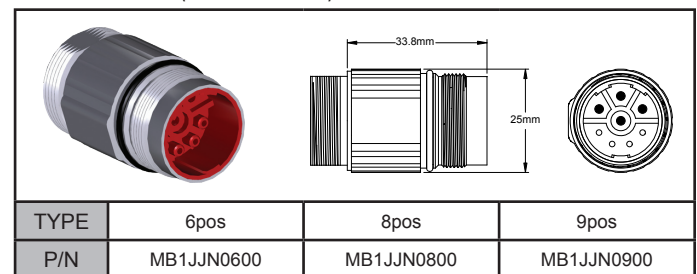

- Plugs accept Sockets only
- Receptacles & Extensions accept Pins only
- For information on RockSolid™, please refer to page 2

# M40 Power Solutions - C Series

Contact Size Legend	
● 2.0mm	● 3.6mm

## M40 C Series (Face view of socket insert)

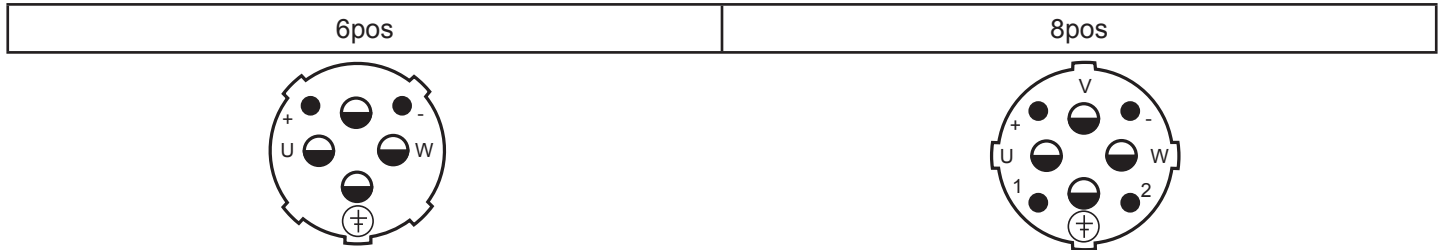

### Plugs (Less contacts)

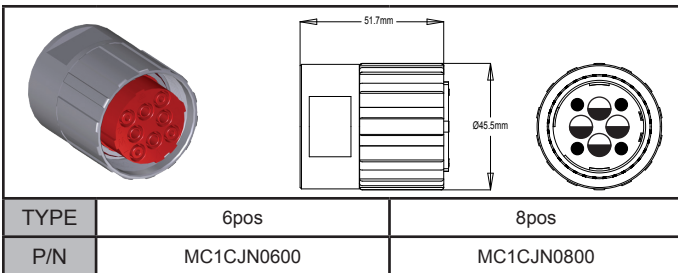

### Fixed 90° Receptacles (Less contacts)

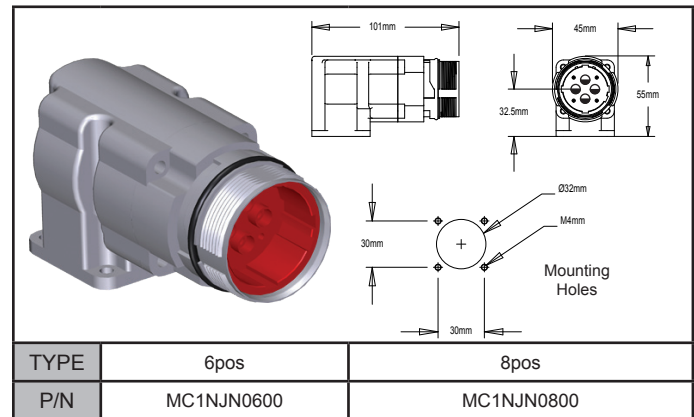

### Straight Receptacles (Less contacts)

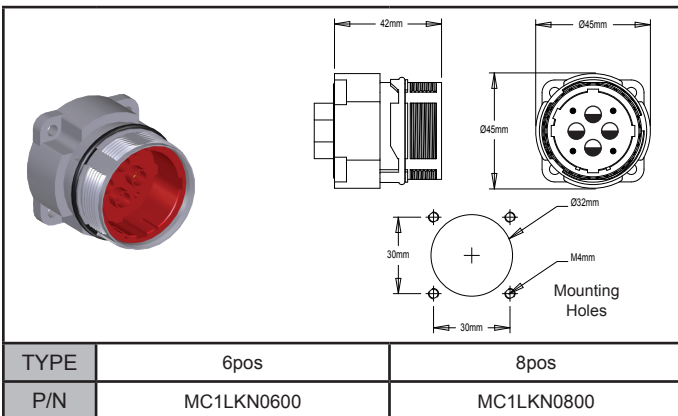

### Extensions (Less contacts)

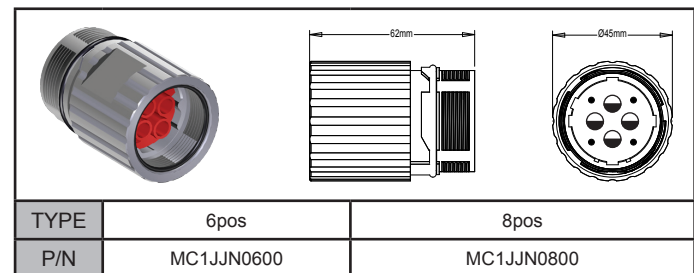

### Pins

### Sockets

PART NUMBER		PART NUMBER			
SC000040	SC000041	SC000014	SC000045	SC000039	SC000046
CONTACT SIZE		CONTACT SIZE			
2.0mm	3.6mm	2.0mm	2.0mm	3.6mm	3.6mm
TYPE		TYPE			
Machined	Machined	RockSolid™	Slit Machined	RockSolid™	Slit Machined
CRIMP BARREL (MAX)		CRIMP BARREL (MAX)			
2.5mm <sup>2</sup> (14 GA)	10.0mm <sup>2</sup> (8 GA)	2.5mm <sup>2</sup> (14 GA)	2.5mm <sup>2</sup> (14 GA)	10.0mm <sup>2</sup> (8 GA)	10.0mm <sup>2</sup> (8 GA)
EXTRACTION TOOL		EXTRACTION TOOL			
50-54931-2	50-54931-3	50-54931-2	50-54931-2	50-54931-3	50-54931-3

- [+] Longer contact life
- [+] Lower contact resistance
- [+] Immunity to shock and vibration
- [+] Low insertion and extraction forces
- [+] Contact area extends 360° around pins

**RockSolid™**  
Connections

- Plugs accept Sockets only
- Receptacles & Extensions accept Pins only

## Contact Tooling

	Universal Hand Crimp Tool		
	SIZE (mm)	OPTION 1	OPTION 2
	1.0mm	UNIVERSAL LOCATOR	SOLID LOCATOR
	PART NUMBER: AFM8	PART NUMBER: SK2/2	PART NUMBER: K613
	2.0mm	UNIVERSAL LOCATOR	SOLID LOCATOR
PART NUMBER: AF8	PART NUMBER: UH2-5	N/A	

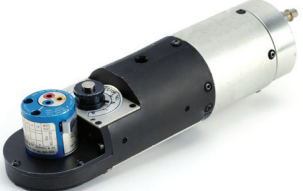
	Pneumatic Crimp Tool	
	SIZE (mm)	OPTION
	1.0mm	UNIVERSAL LOCATOR
	PART NUMBER: WA22	PART NUMBER: SK2/2
	2.0mm	UNIVERSAL LOCATOR
	PART NUMBER: WA27F	PART NUMBER: UH2-5
3.6mm	UNIVERSAL LOCATOR	
PART NUMBER: WA23	PART NUMBER: WA23-1010DA	

## FlexGrip™ Backshells

For more information on FlexGrip™ technology, refer to page 2.

**Note:** FlexGrip™ Backshells must be potted to achieve IP 67 ratings.

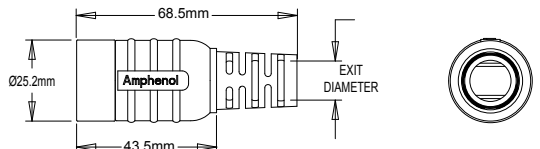
	M23 A SERIES		
	PART NUMBER	EXIT DIAMETER	
	MA4FSR-A8.5	7.5-8.5mm	
	MA4FSR-A10.5	9.5-10.5mm	
	MA4FSR-A12.8	11.5-12.8mm	

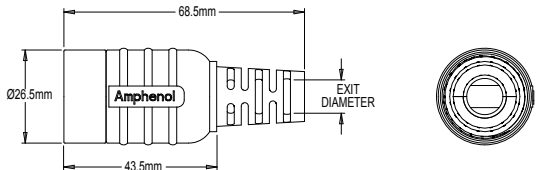

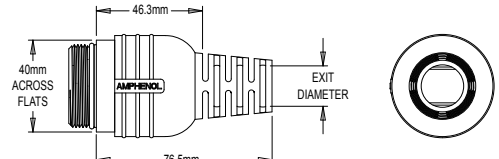

	M23 B SERIES		
	PART NUMBER	EXIT DIAMETER	
	MB4FSR-B10.3	9.5-10.3mm	
	MB4FSR-B12.5	11.5-12.5mm	
	MB4FSR-B14.5	13.5-14.5mm	
MB4FSR-B17	15.5-17mm		

	M40 C SERIES		
	PART NUMBER	EXIT DIAMETER	
	MC4FSR-C18.5	17.5-18.5mm	

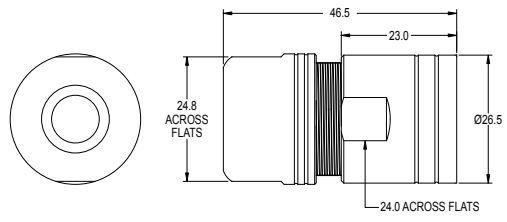

# Cord Grips - Traditional

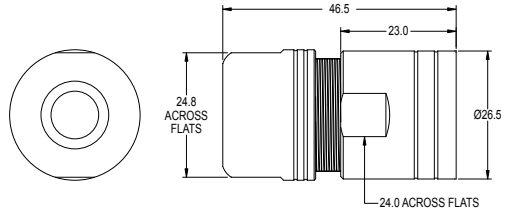
**Note:** Meets IP 67 ratings

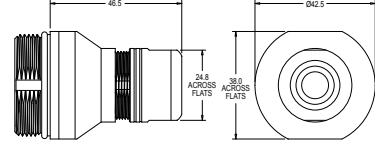
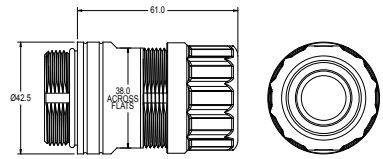
	<b>M23 A SERIES</b>		
	<b>PART NUMBER</b>	<b>CABLE RANGE</b>	
	MA3CG-S1	4.5-7.5mm	
	MA3CG-S2	7.5-11.0mm	
	<b>M23 B SERIES</b>		
	<b>PART NUMBER</b>	<b>CABLE RANGE</b>	
	MB3CG-S1	7.5-11.0mm	
	MB3CG-S2	11.0-14.5mm	
	<b>M40 C SERIES</b>		
	<b>PART NUMBER</b>	<b>CABLE RANGE</b>	
	MC3CG-S1	7.5-11.0mm	
	MC3CG-S2	11.0-14.5mm	
	MC3CG-S3	14.5-17.0mm	
MC3CG-S4	14.5-20.5mm		
MC3CG-S5	20.5-26.0mm		

## Derating Curves

The Derating Curve depicts a safe operating zone in which amperage and ambient temperature are the factors. This curve on the chart is an 80% reduction of the current-carrying capacity curve.

The current-carrying capacity curve is determined from tests in which the mated connectors are subjected to different levels of current. At these levels of current, the temperature of the hottest spot of the mated connector and the temperature inside the test enclosure are recorded. Using this data, plugged into a formula, points are plotted on a chart. When the points are connected, the completed curve is the current-carrying capacity curve.

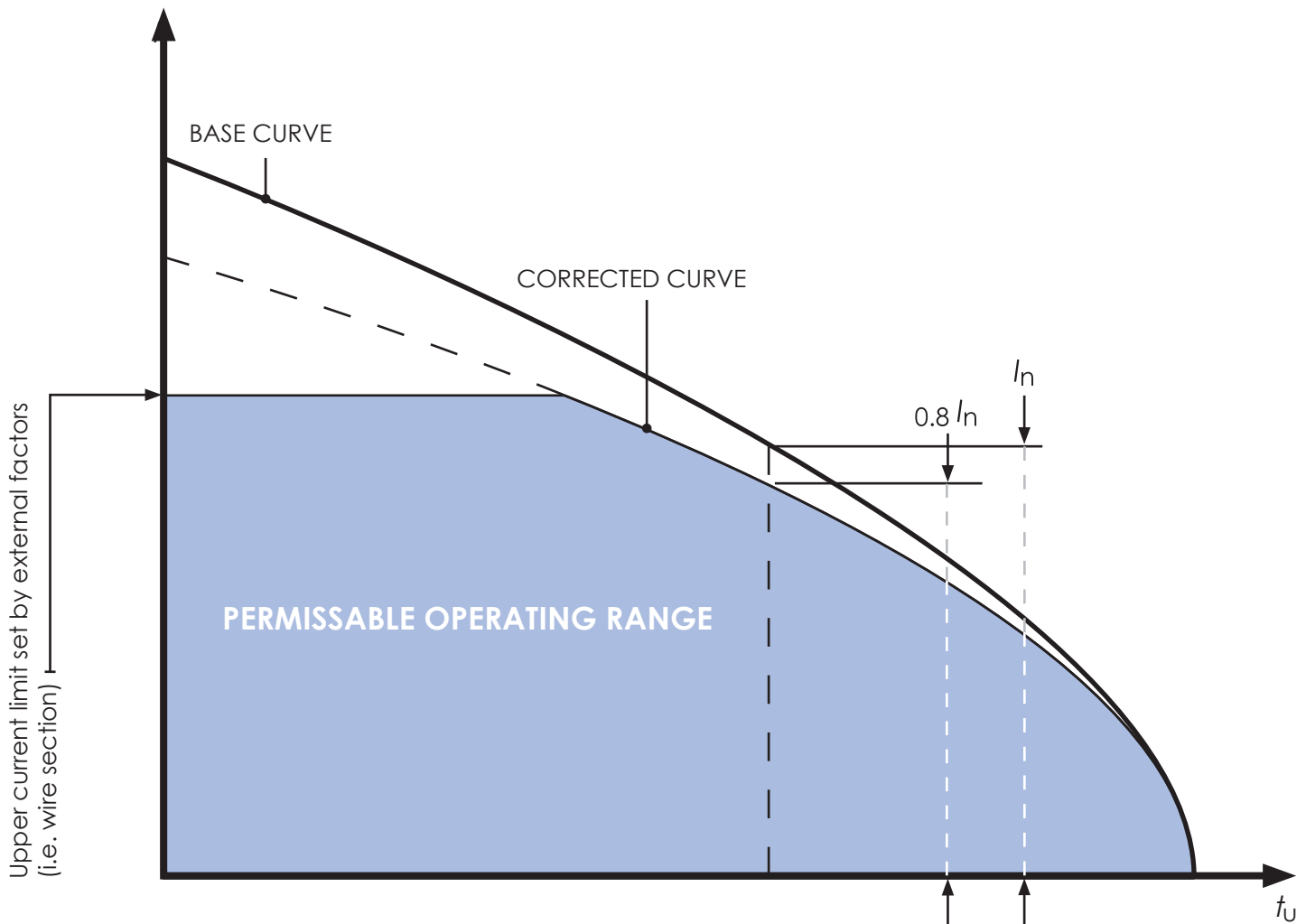

# Catalogs

To view the full line of Amphenol Sine Systems products and/or to request a catalog, please visit our website at [www.sineco.com](http://www.sineco.com)



## NORTH AMERICA

### Amphenol Sine Systems MICHIGAN

44724 Morley Drive  
Clinton Township, MI 48036  
Toll-Free: 1-800-394-7732  
Fax: 1-586-465-1216  
email: sine\_info@sineco.com

### Amphenol Medical Solutions

email: info@sineco.com

### Amphenol Sine Systems FLORIDA

P.O. Box 2340  
22501 Highway 27  
Lake Wales, Florida 33859  
Phone: 1-863-676-9416  
Fax: 1-863-676-7025  
email: sine\_info@sineco.com

### Amphenol Factory Automation

email: inquiries@amphenolfactoryautomation.com

### Amphenol Industrial Operations

40-60 Delaware Avenue  
Sidney, NY 13838  
Phone: 1-800-678-0141  
Fax: 1-607-563-5157

## EUROPE

### Amphenol Air LB SAS

29, voie d' Yvois  
F-08110 Blagny, France  
Phone: 00-333-24-22-32-70  
Fax: 00-333-24-22-38-72  
email: g.dardenne@amphenol-airlb.fr

### Amphenol AIR LB GmbH

Am Kleinbahnhof 4  
Saarlouis D-66740, Germany  
Phone: 49-6831-981-00  
Fax: 49-6831-981-030  
email: info@amphenol-airlb.de

### Amphenol BENELUX

Zadelmaker 121  
NL-2401PD Alphen aan den Rijn  
The Netherlands  
Phone: (31) 172 444903  
Fax: (31) 172 240254  
email: info@amphenol-nl.com

### Amphenol LIMITED

Thanet Way, Whitstable, Kent  
United Kingdom, CT 3JF  
Phone: 44-1227-773-200  
Fax: 44-1227-276-571

### Amphenol ITALIA

Via Barbaiana 5  
20020 Lainate, Milano, Italy  
Phone: 39-02-93254-214  
Mobile: 39-348-7356838  
Fax: 39-02-93254-444  
email: r.buscone@amphenol-it.com

### Amphenol CENTER EAST EUROPE, POLAND and AUSTRIA

Wiener Gasse 68  
2380 Perchtoldsdorf, Austria  
Phone: 43-699-10396071  
Fax: 43-699-40396071  
email: christian@czesch.at

### Amphenol ESPANA

Edificio Burgosol, Oficina N 55  
C/Comunidad de Madrid, 35 bis  
Las Rozas (Madrid), 28230  
Phone: 34-91-6407302  
Mobile: 34-629054629  
Fax: 34-91-6407307  
email: e.bendix@amphenol-it.com

### Amphenol SOCAPEX S.A.S.

948, Promenade de l'Arve - BP 29  
74311 Thyez CEDEX, France  
Phone: 33(0)-4-5089-2800  
Fax: 33(0)-4-5096-2975

### Amphenol NORDIC

Appelboms vag 2  
SE-18642 Vallentuna,  
Sweden  
Phone: 46-76-8418600  
Fax: 46-70-2203197  
email: fredrik.weden@amphenol-socapex.fr

### SOUTH EASTERN EUROPE

Phone: 33(0)-4-5089-2840  
Mobile: 33(0)-6-8281-5763  
email: jocelyne.anthoine@amphenol-socapex.fr

## ASIA

### Amphenol Sine Systems CHINA

Xiamen, Fujian, China  
Phone: 86-592-593-5176  
Mobile: 86-13606072364  
Fax: 86-592-593-1111  
email: cindy.zhao@xm.assembletech.com

### Amphenol INTERCONNECT INDIA PRIVATE LTD

105 Bhosari Industrial Area  
Pune 411 026, India  
Phone: 91-20-712-0363/0463/0155  
Fax: 91-20-712-0581

### Amphenol DAESHIN

558, Songnae-2 Dong, SoSa-Gu  
Bucheon City, Gyeonggi-do, Korea 422-818  
Phone: 81-32-610-3800  
Fax: 81-32-673-2507  
email: info@amphenol.co.kr

### Amphenol JAPAN

689-1, Iseochi, Ritto-shi Shiga 520-3044  
Japan  
Phone: 81-77-553-8501  
Fax: 81-77-551-2200

## OTHER LOCATIONS

### Amphenol MEXICO

Prolongacion Reforma 61-6 B2  
Col. Paseo de las Lomas  
Mexico, DF 01330  
Phone: 52-55-5258-9984  
Fax: 52-55-5081-6890

### Amphenol ARGENTINA

Av. Callao 930 2do piso  
Oficina B Plaza  
C1023, AAP Buenos Aires, Argentina  
Phone: 54-11-4815-6886  
Fax: 54-11-4814-5779

### Amphenol DO BRASIL LTDA

Rua Diogo Moreira, 132, 20 Andar  
CEP:05423-101 Sao Paulo SP, Brazil  
Phone: 55-11-3815-1003  
Fax: 55-11-3815-1629

### Amphenol SOUTH AFRICA

30 Impala Road  
2196 Chislehurst, Sandton  
South Africa  
Phone: 27-11-783-9517  
Fax: 27-11-783-9519

### Amphenol AUSTRALIA PTY LIMITED

2 Fiveways Blvd., Keysborough  
Victoria 3173  
Melbourne, Australia  
Phone: 61-3-8796-8888  
Fax: 61-3-8796-8801

### Amphenol TURKEY

Beybi Giz Plaza, Kat: 26  
34396 Maslak  
Istanbul, Turkey  
Phone: 90-212-335-2501  
Fax: 90-212-335-25-00

### Amphenol BAR TEC LTD

4 Hagavish St., PO Box 279  
Kfar Saba 44102, Israel  
Phone: 972-9-767-4097  
Fax: 972-9-767-4324

### Amphenol RUSSIA

8 Bldg., 2 Yaroslavskaja Street  
129164 Moscow, Russia  
Phone: 7-495-937-6341  
Fax: 7-495-937-6319

© 2012 Amphenol Sine Systems has made every effort to ensure that the information contained in this catalog is accurate at the time of publication. Specifications or information stated in this publication are subject to change without notice.

Компания «Океан Электроники» предлагает заключение долгосрочных отношений при поставках импортных электронных компонентов на взаимовыгодных условиях!

Наши преимущества:

- Поставка оригинальных импортных электронных компонентов напрямую с производств Америки, Европы и Азии, а так же с крупнейших складов мира;
- Широкая линейка поставок активных и пассивных импортных электронных компонентов (более 30 млн. наименований);
- Поставка сложных, дефицитных, либо снятых с производства позиций;
- Оперативные сроки поставки под заказ (от 5 рабочих дней);
- Экспресс доставка в любую точку России;
- Помощь Конструкторского Отдела и консультации квалифицированных инженеров;
- Техническая поддержка проекта, помощь в подборе аналогов, поставка прототипов;
- Поставка электронных компонентов под контролем ВП;
- Система менеджмента качества сертифицирована по Международному стандарту ISO 9001;
- При необходимости вся продукция военного и аэрокосмического назначения проходит испытания и сертификацию в лаборатории (по согласованию с заказчиком);
- Поставка специализированных компонентов военного и аэрокосмического уровня качества (Xilinx, Altera, Analog Devices, Intersil, Interpoint, Microsemi, Actel, Aeroflex, Peregrine, VPT, Syfer, Eurofarad, Texas Instruments, MS Kennedy, Miteq, Cobham, E2V, MA-COM, Hittite, Mini-Circuits, General Dynamics и др.);

Компания «Океан Электроники» является официальным дистрибьютором и эксклюзивным представителем в России одного из крупнейших производителей разъемов военного и аэрокосмического назначения «JONHON», а так же официальным дистрибьютором и эксклюзивным представителем в России производителя высокотехнологичных и надежных решений для передачи СВЧ сигналов «FORSTAR».



## JONHON

«JONHON» (основан в 1970 г.)

Разъемы специального, военного и аэрокосмического назначения:

(Применяются в военной, авиационной, аэрокосмической, морской, железнодорожной, горно- и нефтедобывающей отраслях промышленности)

«FORSTAR» (основан в 1998 г.)

ВЧ соединители, коаксиальные кабели,  
кабельные сборки и микроволновые компоненты:

(Применяются в телекоммуникациях гражданского и специального назначения, в средствах связи, РЛС, а так же военной, авиационной и аэрокосмической отраслях промышленности).



Телефон: 8 (812) 309-75-97 (многоканальный)

Факс: 8 (812) 320-03-32

Электронная почта: [ocean@oceanchips.ru](mailto:ocean@oceanchips.ru)

Web: <http://oceanchips.ru/>

Адрес: 198099, г. Санкт-Петербург, ул. Калинина, д. 2, корп. 4, лит. А