



MAX3224E/MAX3225E/ MAX3226E/MAX3227E/ MAX3244E/MAX3245E

±15kV ESD-Protected, 1µA, 1Mbps, 3.0V to 5.5V, RS-232 Transceivers with AutoShutdown Plus

General Description

The MAX3224E/MAX3225E/MAX3226E/MAX3227E/MAX3244E/MAX3245E are 3V-powered EIA/TIA-232 and V.28/V.24 communications interfaces with automatic shutdown/wakeup features, high data-rate capabilities, and enhanced electrostatic discharge (ESD) protection. All transmitter outputs and receiver inputs are protected to ±15kV using IEC 1000-4-2 Air-Gap Discharge, ±8kV using IEC 1000-4-2 Contact Discharge, and ±15kV using the Human Body Model.

All devices achieve a 1µA supply current using Maxim's revolutionary AutoShutdown Plus™ feature. These devices automatically enter a low-power shutdown mode when the RS-232 cable is disconnected or the transmitters of the connected peripherals are inactive, and the UART driving the transmitter inputs is inactive for more than 30 seconds. They turn on again when they sense a valid transition at any transmitter or receiver input. AutoShutdown Plus saves power without changes to the existing BIOS or operating system.

The MAX3225E/MAX3227E/MAX3245E also feature MegaBaud™ operation, guaranteeing 1Mbps for high-speed applications such as communicating with ISDN modems. The MAX3224E/MAX3226E/MAX3244E guarantee 250kbps operation. The transceivers have a proprietary low-dropout transmitter output stage enabling true RS-232 performance from a +3.0V to +5.5V supply with a dual charge pump. The charge pump requires only four small 0.1µF capacitors for operation from a 3.3V supply. The MAX3224E–MAX3227E feature a logic-level output (READY) that asserts when the charge pump is regulating and the device is ready to begin transmitting.

All devices are available in a space-saving TQFN, SSOP, and TSSOP (MAX3224E/MAX3225E/MAX3244E/MAX3245E) packages.

Applications

- Notebook, Subnotebook, and Palmtop Computers
- Cellular Phones
- Battery-Powered Equipment
- Hand-Held Equipment
- Peripherals
- Printers

Next Generation Device Features

- ◆ For Space-Constrained Applications:
MAX3228E/MAX3229E: ±15kV ESD-Protected, +2.5V to +5.5V, RS-232 Transceivers in UCSP™
MAX3222E/MAX3232E/MAX3241E/MAX3246E: ±15kV ESD-Protected, Down to 10nA, +3.0V to +5.5V, Up to 1Mbps, True RS-232 Transceivers (MAX3246E Available in UCSP)
- ◆ For Low-Voltage or Data Cable Applications:
MAX3380E/MAX3381E: +2.35V to +5.5V, 1µA, 2Tx/2Rx RS-232 Transceivers with ±15kV ESD-Protected I/O and Logic Pins

Ordering Information

PART	TEMP RANGE	PIN-PACKAGE
MAX3224ECTP+	0°C to +70°C	20 TQFN-EP*
MAX3224ECUP+	0°C to +70°C	20 TSSOP
MAX3224ECAP+	0°C to +70°C	20 SSOP
MAX3224ECP+	0°C to +70°C	20 Plastic DIP
MAX3224EETP+	-40°C to +85°C	20 TQFN-EP*
MAX3224EEUP+	-40°C to +85°C	20 TSSOP
MAX3224EEAP+	-40°C to +85°C	20 SSOP
MAX3224EPPP+	-40°C to +85°C	20 Plastic DIP
MAX3224EAAP+	-40°C to +125°C	20 SSOP

+Denotes a lead(Pb)-free/RoHS-compliant package.
*EP = Exposed pad.

Ordering Information continued at end of data sheet.

Selector Guide

PART	NO. OF DRIVERS/RECEIVERS	GUARANTEED DATA RATE (bps)	READY OUTPUT	Auto-Shutdown Plus
MAX3224E	2/2	250k	✓	✓
MAX3225E	2/2	1M	✓	✓
MAX3226E	1/1	250k	✓	✓
MAX3227E	1/1	1M	✓	✓
MAX3244E	3/5	250k	—	✓
MAX3245E	3/5	1M	—	✓

AutoShutdown Plus, MegaBaud, and UCSP are trademarks of Maxim Integrated Products, Inc.

For pricing, delivery, and ordering information, please contact Maxim Direct at 1-888-629-4642, or visit Maxim's website at www.maximintegrated.com.

MAX3224E/MAX3225E/

MAX3226E/MAX3227E/MAX3244E/MAX3245E

±15kV ESD-Protected, 1µA, 1Mbps, 3.0V to 5.5V, RS-232 Transceivers with AutoShutdown Plus

ABSOLUTE MAXIMUM RATINGS

V _{CC} to GND-0.3V to +6V
V ₊ to GND (Note 1)-0.3V to +7V
V ₋ to GND (Note 1)+0.3V to -7V
V ₊ + V ₋ (Note 1)+13V
Input Voltages	
T _{IN} , FORCEON, FORCEOFF to GND-0.3V to +6V
R _{IN} to GND±25V
Output Voltages	
T _{OUT} to GND±13.2V
R _{OUT} , INVALID, READY to GND-0.3V to (V _{CC} + 0.3V)
Short-Circuit Duration	
T _{OUT} to GNDContinuous
Continuous Power Dissipation (T _A = +70°C)	
16-Pin SSOP (derate 7.14mW/°C above +70°C)571mW
16-Pin TSSOP (derate 9.4mW/°C above +70°C)754.7mW
16-Pin TQFN (derate 20.8mW/°C above +70°C)1666.7mW

20-Pin TQFN (derate 21.3mW/°C above +70°C)1702.1mW
20-Pin Plastic DIP (derate 11.11mW/°C above +70°C)889mW
20-Pin SSOP (derate 8.00mW/°C above +70°C)640mW
20-Pin TSSOP (derate 10.9mW/°C above +70°C)879mW
28-Pin Wide SO (derate 12.5mW/°C above +70°C)1W
28-Pin SSOP (derate 9.52mW/°C above +70°C)762mW
28-Pin TSSOP (derate 12.8mW/°C above +70°C)1026mW
36-Pin TQFN (derate 26.3mW/°C above +70°C)2105mW
Operating Temperature Ranges	
MAX32_ _EC_ _0°C to +70°C
MAX32_ _EE_ _-40°C to +85°C
MAX32_ _EAA_ _-40°C to +125°C
Storage Temperature Range	
-65°C to +160°C
Lead Temperature (soldering, 10s)	
+300°C
Soldering Temperature (reflow)	
+260°C

Note 1: V₊ and V₋ can have maximum magnitudes of 7V, but their absolute difference cannot exceed 13V.

Stresses beyond those listed under "Absolute Maximum Ratings" may cause permanent damage to the device. These are stress ratings only, and functional operation of the device at these or any other conditions beyond those indicated in the operational sections of the specifications is not implied. Exposure to absolute maximum rating conditions for extended periods may affect device reliability.

ELECTRICAL CHARACTERISTICS

(V_{CC} = +3V to +5.5V, C₁–C₄ = 0.1µF, tested at 3.3V ±10%; C₁ = 0.047µF, C₂–C₄ = 0.33µF, tested at 5.0V ±10%; T_A = T_{MIN} to T_{MAX}, unless otherwise noted. Typical values are at T_A = +25°C.)

PARAMETER	SYMBOL	CONDITIONS	MIN	TYP	MAX	UNITS	
DC CHARACTERISTICS (V _{CC} = 3.3V or 5.0V, T _A = +25°C)							
Supply Current, AutoShutdown Plus		FORCEON = GND, FORCEOFF = V _{CC} , all R _{IN} idle, all T _{IN} idle		1	10	µA	
Supply Current, Shutdown		FORCEOFF = GND		1	10	µA	
Supply Current, AutoShutdown Plus Disabled		FORCEON = FORCEOFF = V _{CC} , no load		0.3	1	mA	
LOGIC INPUTS AND RECEIVER OUTPUTS							
Input Logic Threshold Low		T _{IN} , FORCEON, FORCEOFF			0.8	V	
Input Logic Threshold High		T _{IN} , FORCEON, FORCEOFF	V _{CC} = 3.3V	2		V	
			V _{CC} = 5.0V	2.4			
Transmitter Input Hysteresis				0.5		V	
Input Leakage Current		T _{IN} , FORCEON, FORCEOFF		±0.01	±1	µA	
Output Leakage Current		R _{OUT} (MAX3244E/MAX3245E), receivers disabled		±0.05	±10	µA	
Output Voltage Low		I _{OUT} = 1.6mA			0.4	V	
Output Voltage High		I _{OUT} = -1.0mA	V _{CC} - 0.6		V _{CC} - 0.1	V	
RECEIVER INPUTS							
Input Voltage Range			-25		+25	V	
Input Threshold Low		T _A = +25°C	V _{CC} = 3.3V	0.6	1.2	V	
			V _{CC} = 5.0V	0.8	1.5		
Input Threshold High		T _A = +25°C	V _{CC} = 3.3V		1.5	2.4	V
			V _{CC} = 5.0V		1.8	2.4	
Input Hysteresis				0.5		V	
Input Resistance		T _A = +25°C	3	5	7	kΩ	

MAX3224E/MAX3225E/ MAX3226E/MAX3227E/MAX3244E/MAX3245E

±15kV ESD-Protected, 1µA, 1Mbps, 3.0V to 5.5V, RS-232 Transceivers with AutoShutdown Plus

ELECTRICAL CHARACTERISTICS (continued)

(V_{CC} = +3V to +5.5V, C₁–C₄ = 0.1µF, tested at 3.3V ±10%; C₁ = 0.047µF, C₂–C₄ = 0.33µF, tested at 5.0V ±10%; T_A = T_{MIN} to T_{MAX}, unless otherwise noted. Typical values are at T_A = +25°C.)

PARAMETER	SYMBOL	CONDITIONS	MIN	TYP	MAX	UNITS
TRANSMITTER OUTPUTS						
Output Voltage Swing		All transmitter outputs loaded with 3kΩ to ground	±5	±5.4		V
Output Resistance		V _{CC} = V ₊ = V ₋ = 0V, transmitter outputs = ±2V	300	10M		Ω
Output Short-Circuit Current					±60	mA
Output Leakage Current		V _{CC} = 0V or 3V to 5.5V, V _{OUT} = ±12V, Transmitters disabled			±25	µA
MOUSE DRIVEABILITY (MAX3244E/MAX3245E)						
Transmitter Output Voltage		T1IN = T2IN = GND, T3IN = V _{CC} , T3OUT loaded with 3kΩ to GND, T1OUT and T2OUT loaded with 2.5mA each	±5			V
ESD PROTECTION						
R _{IN} , T _{OUT}		IEC 1000-4-2 Air Discharge		±15		kV
		IEC 1000-4-2 Contact Discharge		±8		
		Human Body Model		±15		
AutoShutdown Plus (FORCEON = GND, FORCEOFF = V_{CC})						
Receiver Input Threshold to <u>INVALID</u> Output High		Figure 4a	Positive threshold		2.7	V
			Negative threshold	-2.7		
Receiver Input Threshold to <u>INVALID</u> Output Low		Figure 4a	-0.3		+0.3	V
<u>INVALID</u> , READY Output Voltage Low (MAX3224E–MAX3227E)		I _{OUT} = -1.6mA			0.4	V
<u>INVALID</u> , READY Output Voltage High (MAX3224E–MAX3227E)		I _{OUT} = -1.0mA	V _{CC} - 0.6			V
Receiver Positive or Negative Threshold to <u>INVALID</u> High	t _{INVH}	V _{CC} = 5V, Figure 4b		1		µs
Receiver Positive or Negative Threshold to <u>INVALID</u> Low	t _{INVL}	V _{CC} = 5V, Figure 4b		30		µs
Receiver or Transmitter Edge to Transmitters Enabled	t _{WU}	V _{CC} = 5V, Figure 5b (Note 2)		100		µs
Receiver or Transmitter Edge to Transmitters Shutdown	t _{AUTOSHDN}	V _{CC} = 5V, Figure 5b (Note 2)	15	30	60	s

MAX3224E/MAX3225E/

MAX3226E/MAX3227E/MAX3244E/MAX3245E

±15kV ESD-Protected, 1µA, 1Mbps, 3.0V to 5.5V, RS-232 Transceivers with AutoShutdown Plus

TIMING CHARACTERISTICS—MAX3224E/MAX3226E/MAX3244E

(V_{CC} = +3V to +5.5V, C₁–C₄ = 0.1µF, tested at 3.3V ±10%; C₁ = 0.047µF, C₂–C₄ = 0.33µF, tested at 5.0V ±10%; T_A = T_{MIN} to T_{MAX}, unless otherwise noted. Typical values are at T_A = +25°C.)

PARAMETER	SYMBOL	CONDITIONS	MIN	TYP	MAX	UNITS
Maximum Data Rate		R _L = 3kΩ, C _L = 1000pF, one transmitter switching	250			kbps
Receiver Propagation Delay	t _{PHL}	R _{IN} to R _{OUT} , C _L = 150pF		0.15		µs
	t _{PLH}			0.15		
Receiver Output Enable Time		Normal operation (MAX3244E only)		200		ns
Receiver Output Disable Time		Normal operation (MAX3244E only)		200		ns
Transmitter Skew	t _{PHL} - t _{PLH}	(Note 3)		100		ns
Receiver Skew	t _{PHL} - t _{PLH}			50		ns
Transition-Region Slew Rate		V _{CC} = 3.3V, T _A = +25°C, R _L = 3kΩ to 7kΩ, measured from +3V to -3V or -3V to +3V, one transmitter switching			30	V/µs
		C _L = 150pF to 1000pF	6			

TIMING CHARACTERISTICS—MAX3225E/MAX3227E/MAX3245E

(V_{CC} = +3V to +5.5V, C₁–C₄ = 0.1µF, tested at 3.3V ±10%; C₁ = 0.047µF, C₂–C₄ = 0.33µF, tested at 5.0V ±10%; T_A = T_{MIN} to T_{MAX}, unless otherwise noted. Typical values are at T_A = +25°C.)

PARAMETER	SYMBOL	CONDITIONS	MIN	TYP	MAX	UNITS
Maximum Data Rate		R _L = 3kΩ, C _L = 1000pF, one transmitter switching	250			kbps
		V _{CC} = 3.0V to 4.5V, R _L = 3kΩ, C _L = 250pF, one transmitter switching	1000			
		V _{CC} = 4.5V to 5.5V, R _L = 3kΩ, C _L = 1000pF, one transmitter switching	1000			
Receiver Propagation Delay	t _{PHL}	R _{IN} to R _{OUT} , C _L = 150pF		0.15		µs
	t _{PLH}			0.15		
Receiver Output Enable Time		Normal operation (MAX3245E only)		200		ns
Receiver Output Disable Time		Normal operation (MAX3245E only)		200		ns
Transmitter Skew	t _{PHL} - t _{PLH}	(Note 3)		25		ns
Receiver Skew	t _{PHL} - t _{PLH}			50		ns
Transition-Region Slew Rate		V _{CC} = 3.3V, T _A = +25°C, R _L = 3kΩ to 7kΩ, C _L = 150pF to 1000pF, measured from +3V to -3V or -3V to +3V, one transmitter switching			150	V/µs
			24			

Note 2: A transmitter/receiver edge is defined as a transition through the transmitter/receiver input logic thresholds.

Note 3: Transmitter skew is measured at the transmitter zero cross points.

MAX3224E/MAX3225E/ MAX3226E/MAX3227E/MAX3244E/MAX3245E

±15kV ESD-Protected, 1μA, 1Mbps, 3.0V to 5.5V, RS-232 Transceivers with AutoShutdown Plus

Typical Operating Characteristics

($V_{CC} = +3.3V$, 250kbps data rate, 0.1μF capacitors, all transmitters loaded with 3kΩ and C_L , $T_A = +25^\circ C$, unless otherwise noted.)

**MAX3224E/MAX3226E
TRANSMITTER OUTPUT VOLTAGE
vs. LOAD CAPACITANCE**

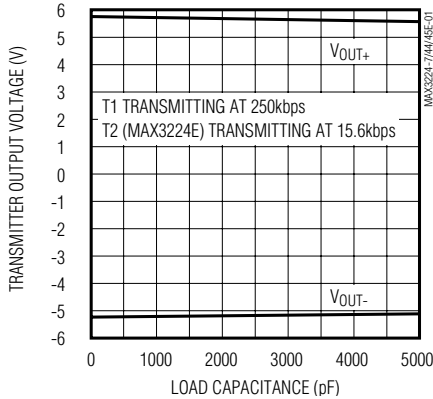

**MAX3224E/MAX3226E
SLEW RATE vs. LOAD CAPACITANCE**

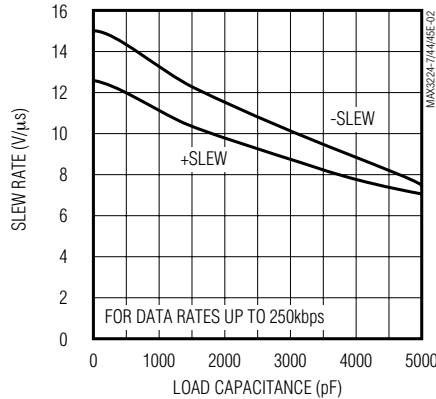

**MAX3224E/MAX3226E
OPERATING SUPPLY CURRENT
vs. LOAD CAPACITANCE**

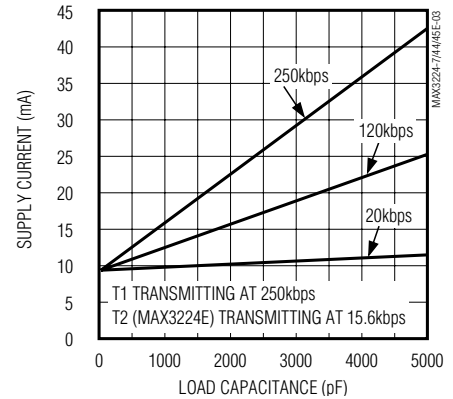

**MAX3225E/MAX3227E
TRANSMITTER OUTPUT VOLTAGE
vs. LOAD CAPACITANCE**

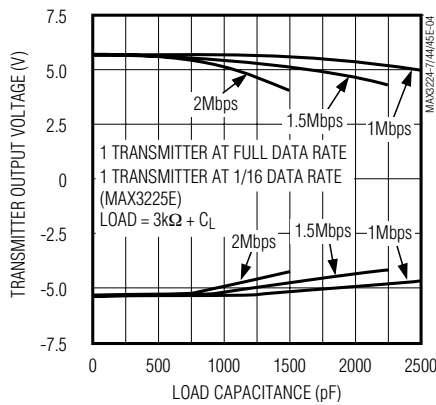

**MAX3225E/MAX3227E
SLEW RATE vs. LOAD CAPACITANCE**

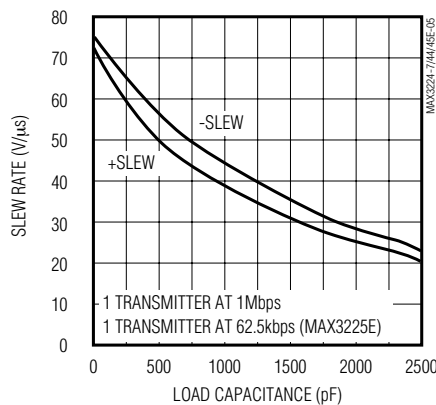

**MAX3225E/MAX3227E
OPERATING SUPPLY CURRENT
vs. LOAD CAPACITANCE**

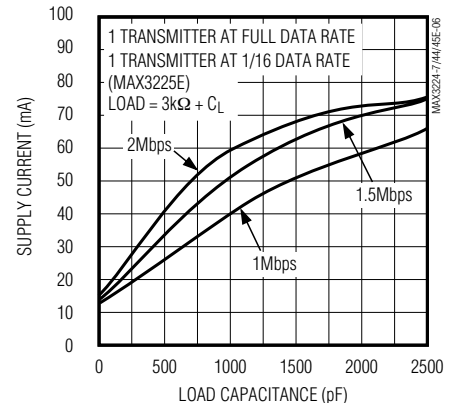

**MAX3225E/MAX3227E
TRANSMITTER SKEW
vs. LOAD CAPACITANCE**

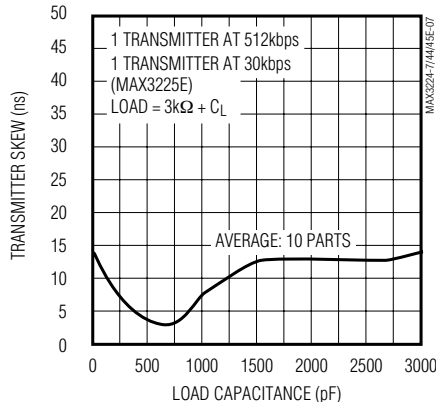

**MAX3224E-MAX3227E
READY TURN-ON TIME
vs. TEMPERATURE**

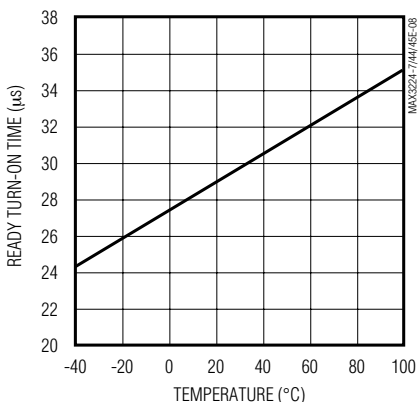

**MAX3224E-MAX3227E
READY TURN-OFF TIME
vs. TEMPERATURE**

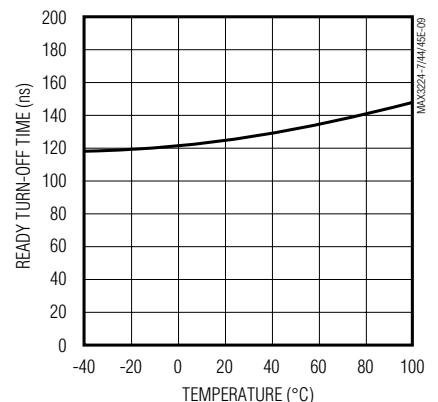

MAX3224E/MAX3225E/

MAX3226E/MAX3227E/MAX3244E/MAX3245E

±15kV ESD-Protected, 1μA, 1Mbps, 3.0V to 5.5V, RS-232 Transceivers with AutoShutdown Plus

Typical Operating Characteristics (continued)

(V_{CC} = +3.3V, 250kbps data rate, 0.1μF capacitors, all transmitters loaded with 3kΩ and C_L, T_A = +25°C, unless otherwise noted.)



MAX3224E/MAX3225E/ MAX3226E/MAX3227E/MAX3244E/MAX3245E

±15kV ESD-Protected, 1µA, 1Mbps, 3.0V to 5.5V, RS-232 Transceivers with AutoShutdown Plus

Pin Description

PIN						NAME	FUNCTION
MAX3224E MAX3225E		MAX3226E MAX3227E		MAX3244E MAX3245E SO/ SSOP/ TSSOP	MAX3245E TQFN		
TQFN	DIP/ SSOP/ TSSOP	TQFN	SSOP/ TSSOP				
19	1	14	1	—	—	READY	Ready to Transmit Output, active-high. READY is enabled high when V- goes below -4V and the device is ready to transmit.
1	2	16	2	28	31	C1+	Positive Terminal of Voltage-Doubler Charge-Pump Capacitor
20	3	15	3	27	30	V+	+5.5V generated by the charge pump
2	4	1	4	24	26	C1-	Negative Terminal of Voltage-Doubler Charge-Pump Capacitor
3	5	2	5	1	33	C2+	Positive Terminal of Inverting Charge-Pump Capacitor
4	6	3	6	2	34	C2-	Negative Terminal of Inverting Charge-Pump Capacitor
5	7	4	7	3	35	V-	-5.5V Generated by the Charge Pump
6, 15	8, 17	10	13	9, 10, 11	7, 8, 9	T_OUT	RS-232 Transmitter Outputs
7, 14	9, 16	5	8	4-8	1-5	R_IN	RS-232 Receiver Inputs
8, 13	10, 15	6	9	15-19	15, 16, 17, 19, 20	R_OUT	TTL/CMOS Receiver Outputs
9	11	7	10	21	23	$\overline{\text{INVALID}}$	Valid Signal Detector Output, active low. A logic high indicates that a valid RS-232 level is present on a receiver input.
10, 11	12, 13	8	11	12-14	11, 12, 13	T_IN	TTL/CMOS Transmitter Inputs

MAX3224E/MAX3225E/ MAX3226E/MAX3227E/MAX3244E/MAX3245E

±15kV ESD-Protected, 1µA, 1Mbps 3.0V to 5.5V, RS-232 Transceivers with AutoShutdown Plus

Pin Description (continued)

PIN						NAME	FUNCTION
MAX3224E MAX3225E		MAX3226E MAX3227E		MAX3244E MAX3245E SO/ SSOP/ TSSOP	MAX3245E TQFN		
TQFN	DIP/ SSOP/ TSSOP	TQFN	SSOP/ TSSOP				
12	14	9	12	23	25	FORCEON	Force-On Input, Active High. Drive high to override AutoShutdown Plus, keeping transmitters and receivers on (FORCEOFF must be high) (Table 1).
16	18	11	14	25	27	GND	Ground
17	19	12	15	26	29	VCC	+3.0V to +5.5V Single Supply Voltage
18	20	13	16	22	24	FORCEOFF	Force-Off Input, Active Low. Drive low to shut down transmitters, receivers (except R2OUTB), and charge pump. This overrides AutoShutdown Plus and FORCEON (Table 1).
—	—	—	—	20	21	R2OUTB	TTL/CMOS Noninverting Complementary Receiver Outputs. Always active.
—	—	—	—	—	6, 10, 14, 18, 22, 28, 32, 36	N.C.	No Connection. Not internally connected.
—	—	—	—	—	—	EP	Exposed Pad. Solder the exposed pad to the ground plane or leave unconnected.

Detailed Description

Dual Charge-Pump Voltage Converter

The MAX3224E–MAX3227E/MAX3244E/MAX3245E's internal power supply consists of a regulated dual charge pump that provides output voltages of +5.5V (doubling charge pump) and -5.5V (inverting charge pump), over the +3.0V to +5.5V range. The charge pump operates in discontinuous mode: if the output voltages are less than 5.5V, the charge pump is

enabled; if the output voltages exceed 5.5V, the charge-pump is disabled. Each charge pump requires a flying capacitor (C1, C2) and a reservoir capacitor (C3, C4) to generate the V+ and V- supplies.

The READY output (MAX3224E–MAX3227E) is low when the charge pumps are disabled in shutdown mode. The READY signal asserts high when V- goes below -4V.

MAX3224E/MAX3225E/ MAX3226E/MAX3227E/MAX3244E/MAX3245E

±15kV ESD-Protected, 1µA, 1Mbps 3.0V to 5.5V, RS-232 Transceivers with AutoShutdown Plus

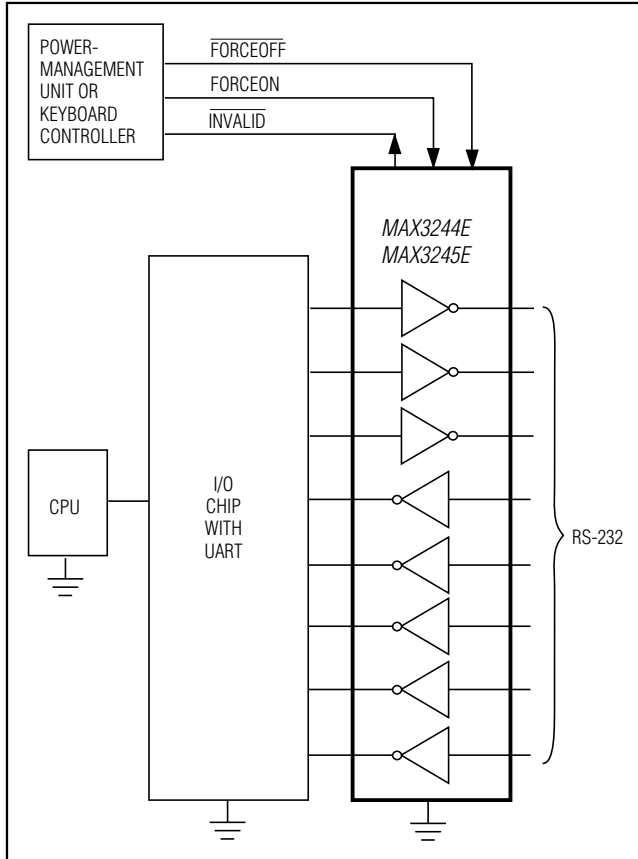

Figure 1. Interface Under Control of PMU

RS-232 Transmitters

The transmitters are inverting level translators that convert CMOS-logic levels to 5.0V EIA/TIA-232 levels. The MAX3224E/MAX3226E/MAX3244E guarantee a 250kbps data rate (1Mbps, for the MAX3225E/MAX3227E/MAX3245E) with worst-case loads of 3kΩ in parallel with 1000pF, providing compatibility with PC-to-PC communication software (such as LapLink®). Transmitters can be paralleled to drive multiple receivers. Figure 1 shows a complete system connection.

When $\overline{\text{FORCEOFF}}$ is driven to ground or when the Auto-Shutdown Plus circuitry senses that all receiver and transmitter inputs are inactive for more than 30s, the transmitters are disabled and the outputs go into a high-impedance state. When powered off or shut down, the outputs can be driven to ±12V. The transmitter inputs do not have pullup resistors. Connect unused inputs to GND or VCC.

LapLink is a registered trademark of Laplink Software, Inc.

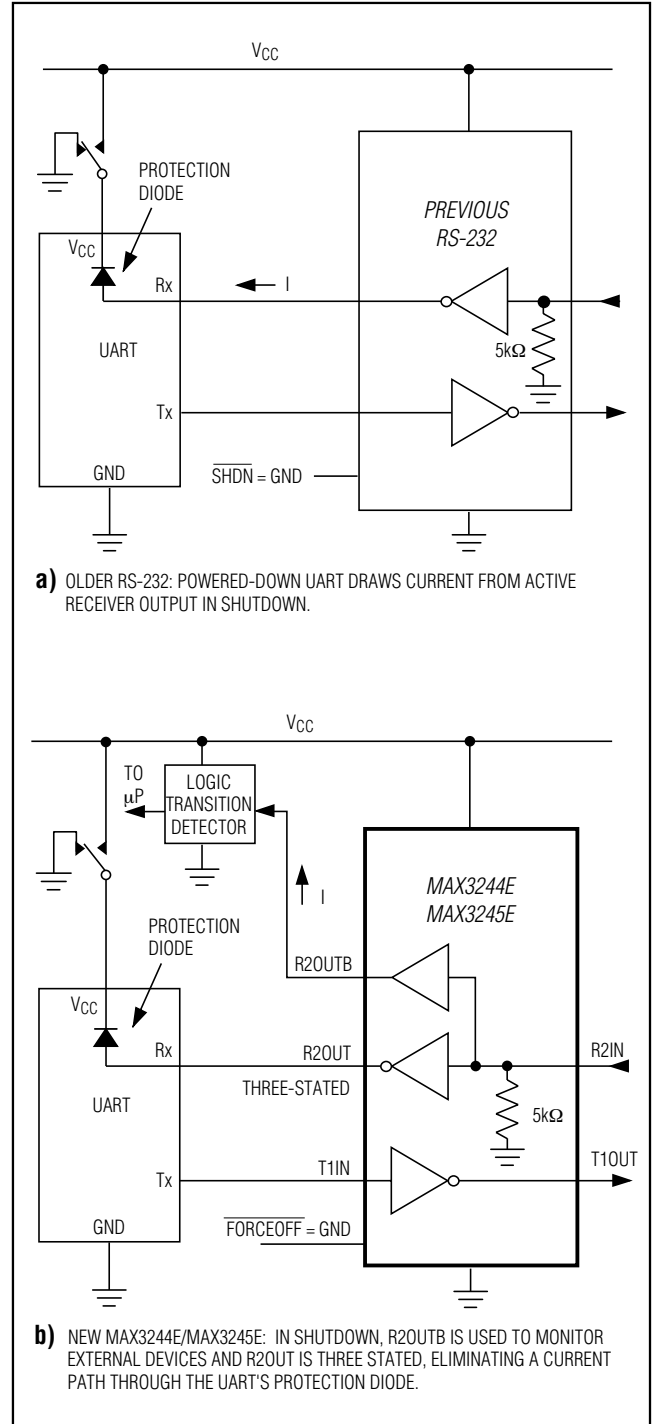

Figure 2. The MAX3224E/MAX3245E detect RS-232 activity when the UART and interface are shut down.

MAX3224E/MAX3225E/ MAX3226E/MAX3227E/MAX3244E/MAX3245E

±15kV ESD-Protected, 1µA, 1Mbps 3.0V to 5.5V, RS-232 Transceivers with AutoShutdown Plus

Table 1. Output Control Truth Table

OPERATION STATUS	FORCEON	$\overline{\text{FORCEOFF}}$	VALID RECEIVER LEVEL	RECEIVER OR TRANSMITTER EDGE WITHIN 30s	T_OUT	R_OUT (MAX3224E/MAX3225E/MAX3226E/MAX3227E)	R_OUT (MAX3244E/MAX3245E)	R2OUTB (MAX3244E/MAX3245E)
Shutdown (Forced Off)	X	0	X	X	High-Z	Active	High-Z	Active
Normal Operation (Forced On)	1	1	X	X	Active	Active	Active	Active
Normal Operation (AutoShutdown Plus)	0	1	X	Yes	Active	Active	Active	Active
Shutdown (Auto-Shutdown Plus)	0	1	X	No	High-Z	Active	Active	Active
Normal Operation	$\overline{\text{INVALID}}^*$	1	Yes	X	Active	Active	Active	Active
Normal Operation	$\overline{\text{INVALID}}^*$	1	X	Yes	Active	Active	Active	Active
Shutdown	$\overline{\text{INVALID}}^*$	1	No	No	High-Z	Active	Active	Active
Normal Operation (AutoShutdown)	$\overline{\text{INVALID}}^*$	$\overline{\text{INVALID}}^{**}$	Yes	X	Active	Active	Active	Active
Shutdown (AutoShutdown)	$\overline{\text{INVALID}}^*$	$\overline{\text{INVALID}}^{**}$	No	X	High-Z	Active	High-Z	Active

X = Don't care

* $\overline{\text{INVALID}}$ connected to FORCEON

** $\overline{\text{INVALID}}$ connected to FORCEON and $\overline{\text{FORCEOFF}}$

RS-232 Receivers

The receivers convert RS-232 signals to CMOS-logic output levels. The MAX3224E–MAX3227E feature inverting outputs that always remain active (Table 1). The MAX3244E/MAX3245E have inverting three-state outputs that are high impedance when shut down ($\overline{\text{FORCEOFF}} = \text{GND}$) (Table 1).

The MAX3244E/MAX3245E feature an extra, always active, noninverting output, R2OUTB. R2OUTB output monitors receiver activity while the other receivers are high impedance, allowing ring indicator applications to be monitored without forward biasing other devices connected to the receiver outputs. This is ideal for systems where VCC is set to ground in shutdown to accommodate peripherals such as UARTs (Figure 2).

The MAX3224E–MAX3227E/MAX3244E/MAX3245E feature an $\overline{\text{INVALID}}$ output that is enabled low when no valid RS-232 voltage levels have been detected on all receiver inputs. Because $\overline{\text{INVALID}}$ indicates the receiver input's condition, it is independent of FORCEON and $\overline{\text{FORCEOFF}}$ states (Figures 3 and 4).

AutoShutdown Plus Mode

The MAX3224E–MAX3227E/MAX3244E/MAX3245E achieve a 1µA supply current with Maxim's AutoShutdown Plus feature, which operates when $\overline{\text{FORCEOFF}}$ is high and a FORCEON is low. When these devices do not sense a valid signal transition on any receiver and transmitter input for 30s, the on-board charge pumps are shut down, reducing supply current to 1µA. This occurs if the RS-232 cable is disconnected or if the connected

MAX3224E/MAX3225E/ MAX3226E/MAX3227E/MAX3244E/MAX3245E

±15kV ESD-Protected, 1µA, 1Mbps 3.0V to 5.5V, RS-232 Transceivers with AutoShutdown Plus



Figure 3a. $\overline{\text{INVALID}}$ Functional Diagram, $\overline{\text{INVALID}}$ Low



Figure 3c. AutoShutdown Plus Logic



Figure 3b. $\overline{\text{INVALID}}$ Functional Diagram, $\overline{\text{INVALID}}$ High



Figure 3d. Power-Down Logic

Table 2. $\overline{\text{INVALID}}$ Truth Table

RS-232 SIGNAL PRESENT AT ANY RECEIVER INPUT	$\overline{\text{INVALID}}$ OUTPUT
Yes	High
No	Low

peripheral transmitters are turned off, and the UART driving the transmitter inputs is inactive. The system turns on again when a valid transition is applied to any RS-232 receiver or transmitter input. As a result, the system saves power without changes to the existing BIOS or operating system.

Figures 3a and 3b depict valid and invalid RS-232 receiver voltage levels. $\overline{\text{INVALID}}$ indicates the receiver input's condition, and is independent of FORCEON and FORCEOFF states. Figure 3 and Tables 1 and 2 summarize the operating modes of the MAX3224E–MAX3227E/MAX3244E/MAX3245E. FORCEON and FORCEOFF override AutoShutdown Plus circuitry. When neither control is asserted, the IC selects between these states automatically based on the last receiver or transmitter input edge received.

When shut down, the device's charge pumps turn off, V+ is pulled to VCC, V- is pulled to ground, the transmitter outputs are high impedance, and READY (MAX3224E–MAX3227E) is driven low. The time required to exit shutdown is typically 100µs (Figure 8).

By connecting FORCEON to $\overline{\text{INVALID}}$, the MAX3224E–MAX3227E/MAX3244E/MAX3245E shut down when no valid receiver level and no receiver or transmitter edge is detected for 30s, and wake up when a valid receiver level or receiver or transmitter edge is detected.



Figure 4a. Receiver Positive/Negative Thresholds for $\overline{\text{INVALID}}$

MAX3224E/MAX3225E/

MAX3226E/MAX3227E/MAX3244E/MAX3245E

±15kV ESD-Protected, 1µA, 1Mbps 3.0V to 5.5V, RS-232 Transceivers with AutoShutdown Plus



Figure 4b. AutoShutdown Plus, $\overline{\text{INVALID}}$, and READY Timing Diagram

By connecting FORCEON and FORCEOFF to $\overline{\text{INVALID}}$, the MAX3224E-MAX3227E/MAX3244E/MAX3245E shut down when no valid receiver level is detected and wake up when a valid receiver level is detected (same functionality as AutoShutdown feature on MAX3221E/MAX3223E/MAX3243E).

A mouse or other system with AutoShutdown Plus may need time to wake up. Figure 5 shows a circuit that forces the transmitters on for 100ms, allowing enough time for the other system to realize that the MAX3244E/MAX3245E is awake. If the other system outputs valid RS-232 signal transitions within that time, the RS-232 ports on both systems remain enabled.

Software-Controlled Shutdown

If direct software control is desired, use $\overline{\text{INVALID}}$ to indicate DTR or ring indicator signal. Tie FORCEOFF and FORCEON together to bypass the AutoShutdown Plus so the line acts like a $\overline{\text{SHDN}}$ input.

±15kV ESD Protection

As with all Maxim devices, ESD-protection structures are incorporated on all pins to protect against electrostatic

discharges encountered during handling and assembly. The driver outputs and receiver inputs of the MAX3224E-MAX3227E/MAX3244E/MAX3245E have extra protection against static electricity. Maxim's engineers have developed state-of-the-art structures to protect



Figure 5. AutoShutdown Plus Initial Turn-On to Wake Up a Mouse or Another System

MAX3224E/MAX3225E/ MAX3226E/MAX3227E/MAX3244E/MAX3245E

±15kV ESD-Protected, 1µA, 1Mbps 3.0V to 5.5V, RS-232 Transceivers with AutoShutdown Plus



Figure 6a. Human Body ESD Test Model



Figure 7a. IEC 1000-4-2 ESD Test Model



Figure 6b. Human Body Current Waveform

these pins against ESD of ±15kV without damage. The ESD structures withstand high ESD in all states: normal operation, shutdown, and powered down. After an ESD event, Maxim's E versions keep working without latchup, whereas competing RS-232 products can latch and must be powered down to remove latchup.

ESD protection can be tested in various ways; the transmitter outputs and receiver inputs of this product family are characterized for protection to the following limits:

- 1) ±15kV using the Human Body Model
- 2) ±8kV using the Contact-Discharge Method specified in IEC 1000-4-2
- 3) ±15kV using IEC 1000-4-2's Air-Gap Method.



Figure 7b. IEC 1000-4-2 ESD Generator Current Waveform

ESD Test Conditions

ESD performance depends on a variety of conditions. Contact Maxim for a reliability report that documents test setup, test methodology, and test results.

Human Body Model

Figure 6a shows the Human Body Model and Figure 6b shows the current waveform it generates when discharged into a low impedance. This model consists of a 100pF capacitor charged to the ESD voltage of interest, which is then discharged into the test device through a 1.5kΩ resistor.

MAX3224E/MAX3225E/

MAX3226E/MAX3227E/MAX3244E/MAX3245E

±15kV ESD-Protected, 1µA, 1Mbps 3.0V to 5.5V, RS-232 Transceivers with AutoShutdown Plus

IEC 1000-4-2

The IEC 1000-4-2 standard covers ESD testing and performance of finished equipment; it does not specifically refer to integrated circuits. The MAX3224E–MAX3227E, MAX3244E/MAX3245E help you design equipment that meets Level 4 (the highest level) of IEC 1000-4-2, without the need for additional ESD-protection components.

The major difference between tests done using the Human Body Model and IEC 1000-4-2 is higher peak current in IEC 1000-4-2, because series resistance is lower in the IEC 1000-4-2 model. Hence, the ESD withstand voltage measured to IEC 1000-4-2 is generally lower than that measured using the Human Body Model. Figure 7a shows the IEC 1000-4-2 model and Figure 7b shows the current waveform for the 8kV, IEC 1000-4-2, Level 4, ESD Contact-Discharge Method.

The Air-Gap Method involves approaching the device with a charged probe. The Contact-Discharge Method connects the probe to the device before the probe is energized.

Machine Model

The Machine Model for ESD tests all pins using a 200pF storage capacitor and zero discharge resistance. Its objective is to emulate the stress caused by contact that occurs with handling and assembly during manufacturing. Of course, all pins require this protection during manufacturing, not just RS-232 inputs and outputs. Therefore, after PC board assembly, the Machine Model is less relevant to I/O ports.

Applications Information

Capacitor Selection

The capacitor type used for C1–C4 is not critical for proper operation; polarized or nonpolarized capacitors

Table 3. Required Minimum Capacitance Values

V _{CC} (V)	C1, C _{BYPASS} (µF)	C2, C3, C4 (µF)
3.0 to 3.6	0.22	0.22
3.15 to 3.6	0.1	0.1
4.5 to 5.5	0.047	0.33
3.0 to 5.5	0.22	1

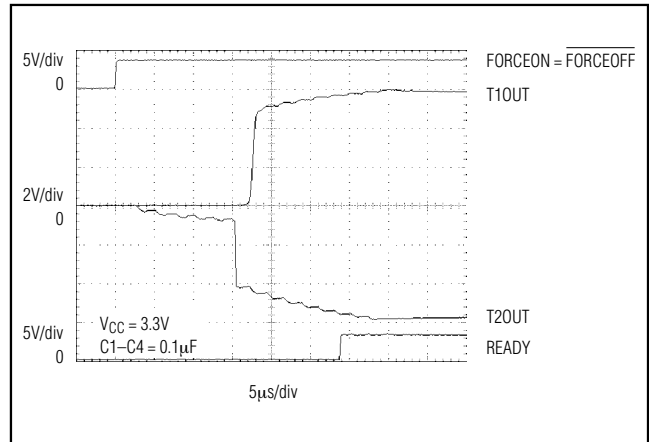

Figure 8. Transmitter Outputs when Exiting Shutdown or Powering Up

can be used. The charge pump requires 0.1µF capacitors for 3.3V operation. For other supply voltages, see Table 3 for required capacitor values. Do not use values smaller than those listed in Table 3. Increasing the capacitor values (e.g., by a factor of 2) reduces ripple on the transmitter outputs and slightly reduces power consumption. C2, C3, and C4 can be increased without changing C1's value. **However, do not increase C1 without also increasing the values of C2, C3, C4, and CBYPASS, to maintain the proper ratios (C1 to the other capacitors).**

When using the minimum required capacitor values, make sure the capacitor value does not degrade excessively with temperature. If in doubt, use capacitors with a larger nominal value. The capacitor's equivalent series resistance (ESR), which usually rises at low temperatures, influences the amount of ripple on V+ and V-.

Power-Supply Decoupling

In most circumstances, a 0.1µF V_{CC} bypass capacitor is adequate. In applications that are sensitive to power-supply noise, use a capacitor of the same value as charge-pump capacitor C1. Connect bypass capacitors as close to the IC as possible.

Transmitter Outputs when Exiting Shutdown

Figure 8 shows two transmitter outputs when exiting shutdown mode. As they become active, the two transmitter outputs are shown going to opposite RS-232 levels (one transmitter input is high, the other is low). Each

MAX3224E/MAX3225E/ MAX3226E/MAX3227E/MAX3244E/MAX3245E

±15kV ESD-Protected, 1μA, 1Mbps 3.0V to 5.5V, RS-232 Transceivers with AutoShutdown Plus

transmitter is loaded with 3kΩ in parallel with 1000pF. The transmitter outputs display no ringing or undesirable transients as they come out of shutdown. Note that the transmitters are enabled only when the magnitude of V- exceeds approximately -3V.

High Data Rates

The MAX3224E/MAX3226E/MAX3244E maintain the RS-232 ±5.0V minimum transmitter output voltage even at high data rates. Figure 9 shows a transmitter loopback test circuit. Figure 10 shows a loopback test result at 120kbps, and Figure 11 shows the same test at 250kbps. For Figure 10, all transmitters were driven simultaneously at 120kbps into RS-232 loads in parallel with 1000pF. For Figure 11, a single transmitter was driven at 250kbps, and all transmitters were loaded with an RS-232 receiver in parallel with 250pF.

The MAX3225E/MAX3227E/MAX3245E maintain the RS-232 ±5.0V minimum transmitter output voltage at data rates up to 1Mbps (MegaBaud). Figure 12 shows a loopback test result with a single transmitter driven at 1Mbps and all transmitters loaded with an RS-232 receiver in parallel with 250pF.



Figure 9. Loopback Test Circuit



Figure 10. MAX3224E/MAX3226E/MAX3244E Loopback Test Result at 120kbps

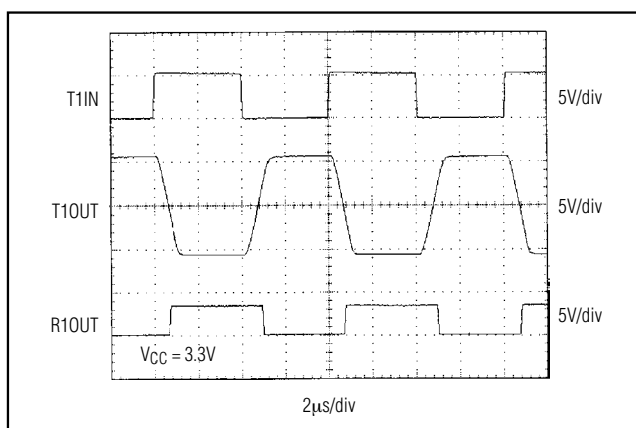

Figure 11. MAX3224E/MAX3226E/MAX3244E Loopback Test Result at 250kbps



Figure 12. MAX3225E/MAX3227E/MAX3245E Loopback Test Result at 1Mbps

MAX3224E/MAX3225E/ MAX3226E/MAX3227E/MAX3244E/MAX3245E

±15kV ESD-Protected, 1µA, 1Mbps 3.0V to 5.5V, RS-232 Transceivers with AutoShutdown Plus



Figure 13a. Mouse Driver Test Circuit

MAX3224E/MAX3225E/ MAX3226E/MAX3227E/MAX3244E/MAX3245E

±15kV ESD-Protected, 1µA, 1Mbps 3.0V to 5.5V, RS-232 Transceivers with AutoShutdown Plus



Figure 13b. MAX324_E Transmitter Output Voltage vs. Load Current per Transmitter

Mouse Driveability

The MAX3244E/MAX3245E are specifically designed to power serial mice while operating from low-voltage power supplies. They have been tested with leading mouse brands from manufacturers such as Microsoft and Logitech. The MAX3244E/MAX3245E successfully drove all serial mice tested and met their respective current and voltage requirements. The MAX3244E/MAX3245E dual charge pump ensures the transmitters supply at least ±5V during worst-case conditions. Figure 13b shows the transmitter output voltages under increasing load current. Figure 13a shows a typical mouse connection.

Interconnection with 3V and 5V Logic

The MAX3224E–MAX3227E/MAX3244E/MAX3245E can directly interface with various 5V logic families, including ACT and HCT CMOS. See Table 4 for more information on possible combinations of interconnections.

Table 5 lists other Maxim ESD-powered transceivers.

Table 4. Logic Family Compatibility with Various Supply Voltages

SYSTEM POWER-SUPPLY VOLTAGE (V)	V _{CC} SUPPLY VOLTAGE (V)	COMPATIBILITY
3.3	3.3	Compatible with all CMOS families
5	5	Compatible with all TTL and CMOS families
5	3.3	Compatible with ACT and HCT CMOS, and with AC, HC, or CD4000 CMOS

Table 5. ±15kV ESD-Protected, 3.0V to 5.5V Powered RS-232 Transceivers from Maxim

PART	SUPPLY VOLTAGE RANGE (V)	NO. OF Tx/Rx	SUPPLY CURRENT (µA)	Auto-Shutdown Plus	Auto-Shutdown	Human Body Model (kV)	IEC 1000-4-2 Contact Discharge (kV)	IEC 1000-4-2 Air-Gap Discharge (kV)	GUARANTEED DATA RATE (kbps)
MAX3241E	+3.0 to +5.5	3/5	300	—	—	±15	±8	±15	250
MAX3243E	+3.0 to +5.5	3/5	1	—	Yes	±15	±8	±15	250
MAX3244E	+3.0 to +5.5	3/5	1	Yes	—	±15	±8	±15	250
MAX3245E	+3.0 to +5.5	3/5	1	Yes	—	±15	±8	±15	1Mbps
MAX3232E	+3.0 to +5.5	2/2	300	—	—	±15	±8	±15	250
MAX3222E	+3.0 to +5.5	2/2	300	—	—	±15	±8	±15	250
MAX3223E	+3.0 to +5.5	2/2	1	—	Yes	±15	±8	±15	250
MAX3224E	+3.0 to +5.5	2/2	1	Yes	—	±15	±8	±15	250
MAX3225E	+3.0 to +5.5	2/2	1	Yes	—	±15	±8	±15	1Mbps
MAX3221E	+3.0 to +5.5	1/1	1	—	Yes	±15	±8	±15	250
MAX3226E	+3.0 to +5.5	1/1	1	Yes	—	±15	±8	±15	250
MAX3227E	+3.0 to +5.5	1/1	1	Yes	—	±15	±8	±15	1Mbps

MAX3224E/MAX3225E/

MAX3226E/MAX3227E/MAX3244E/MAX3245E

±15kV ESD-Protected, 1µA, 1Mbps 3.0V to 5.5V, RS-232 Transceivers with AutoShutdown Plus

Typical Operating Circuits



*MAX3226E/MAX3227E PIN OUT REFERS TO SSOP/TSSOP PACKAGES.
 **MAX3224E/MAX3225E PIN OUT REFERS TO DIP/ SSOP/TSSOP PACKAGES.
 ***MAX3244E/MAX3245E PIN OUT REFERS TO SO/SSOP/TSSOP PACKAGES.

MAX3224E/MAX3225E/ MAX3226E/MAX3227E/MAX3244E/MAX3245E

±15kV ESD-Protected, 1µA, 1Mbps 3.0V to 5.5V, RS-232 Transceivers with AutoShutdown Plus

Pin Configurations

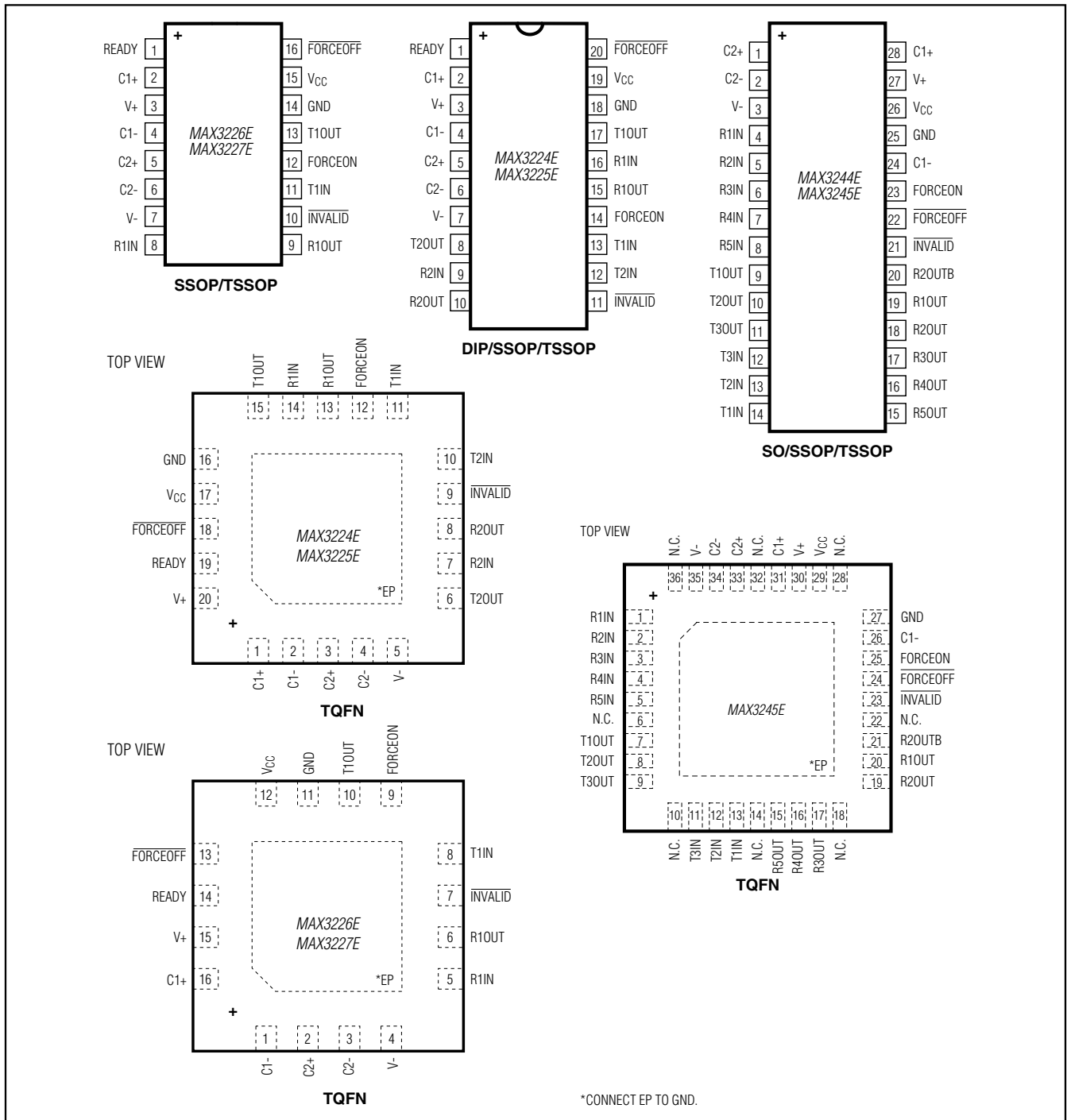

MAX3224E/MAX3225E/

MAX3226E/MAX3227E/MAX3244E/MAX3245E

±15kV ESD-Protected, 1µA, 1Mbps 3.0V to 5.5V, RS-232 Transceivers with AutoShutdown Plus

Ordering Information (continued)

PART	TEMP RANGE	PIN-PACKAGE
MAX3225ECUP+	0°C to +70°C	20 TSSOP
MAX3225ECTP+	0°C to +70°C	20 TQFN-EP*
MAX3225ECAP+	0°C to +70°C	20 SSOP
MAX3225ECP+	0°C to +70°C	20 Plastic DIP
MAX3225EETP+	-40°C to +85°C	20 TQFN-EP*
MAX3225EEUP+	-40°C to +85°C	20 TSSOP
MAX3225EEAP+	-40°C to +85°C	20 SSOP
MAX3225EPP+	-40°C to +85°C	20 Plastic DIP
MAX3225EAA+P+	-40°C to +125°C	20 SSOP
MAX3226ECTE+	0°C to +70°C	16 TQFN-EP*
MAX3226ECUE+	0°C to +70°C	16 TSSOP
MAX3226ECAE+	0°C to +70°C	16 SSOP
MAX3226EEAE+	-40°C to +85°C	16 SSOP
MAX3226EETE+	-40°C to +85°C	16 TQFN-EP*
MAX3226EEUE+	-40°C to +85°C	16 TSSOP
MAX3226EAAE+	-40°C to +125°C	16 SSOP
MAX3227ECAE+	0°C to +70°C	16 SSOP
MAX3227ECTE+	0°C to +70°C	16 TQFN-EP*
MAX3227ECUE+	0°C to +70°C	16 TSSOP
MAX3227EEAE+	-40°C to +85°C	16 SSOP
MAX3227EEAE/V+	-40°C to +85°C	16 SSOP
MAX3227EETE+	-40°C to +85°C	16 TQFN-EP*
MAX3227EEUE+	-40°C to +85°C	16 TSSOP
MAX3227EAAE+	-40°C to +125°C	16 SSOP
MAX3244ECWI+	0°C to +70°C	28 Wide SO
MAX3244ECAI+	0°C to +70°C	28 SSOP
MAX3244ECUI+	0°C to +70°C	28 TSSOP
MAX3244EEWI+	-40°C to +85°C	28 Wide SO
MAX3244EEAI+	-40°C to +85°C	28 SSOP
MAX3244EEUI+	-40°C to +85°C	28 TSSOP
MAX3245ECWI+	0°C to +70°C	28 Wide SO
MAX3245ECAI+	0°C to +70°C	28 SSOP
MAX3245ECTX+	0°C to +70°C	36 TQFN-EP*
MAX3245EEAI+	-40°C to +85°C	28 SSOP
MAX3245EEWI+	-40°C to +85°C	28 WIDE SO
MAX3245EEUI+	-40°C to +85°C	28 TSSOP
MAX3245EETX+	-40°C to +85°C	36 TQFN-EP*

+Denotes a lead(Pb)-free/RoHS-compliant package.

*EP = Exposed pad.

/V denotes an automotive qualified part.

Chip Information

PROCESS: BICMOS

Package Information

For the latest package outline information and land patterns (footprints), go to www.maxim-ic.com/packages. Note that a "+", "#", or "-" in the package code indicates RoHS status only. Package drawings may show a different suffix character, but the drawing pertains to the package regardless of RoHS status.

PACKAGE TYPE	PACKAGE CODE	OUTLINE NO.	LAND PATTERN NO.
16 SSOP	A16+2	21-0056	90-0106
16 TSSOP	U16+1	21-0066	90-0117
16 TQFN-EP	T1655+2	21-0140	90-0072
20 DIP	P20+3	21-0043	—
20 SSOP	A20+1	21-0056	90-0094
20 TSSOP	U20+2	21-0066	90-0116
20 TQFN-EP	T2055+5	21-0140	90-0010
28 Wide SO	W28+6	21-0042	90-0109
28 SSOP	A28+1	21-0056	90-0095
28 TSSOP	U28+2	21-0066	90-0171
36 TQFN	T3666+3	21-0141	90-0050

**MAX3224E/MAX3225E/
MAX3226E/MAX3227E/MAX3244E/MAX3245E
±15kV ESD-Protected, 1μA, 1Mbps 3.0V to 5.5V,
RS-232 Transceivers with AutoShutdown Plus**

Revision History

REVISION NUMBER	REVISION DATE	DESCRIPTION	PAGES CHANGED
10	3/11	Added an automotive qualified part to the <i>Ordering Information</i> ; changed all the parts listed in the <i>Ordering Information</i> to lead free	1, 20



Maxim cannot assume responsibility for use of any circuitry other than circuitry entirely embodied in a Maxim product. No circuit patent licenses are implied. Maxim reserves the right to change the circuitry and specifications without notice at any time. The parametric values (min and max limits) shown in the Electrical Characteristics table are guaranteed. Other parametric values quoted in this data sheet are provided for guidance.

Maxim Integrated 160 Rio Robles, San Jose, CA 95134 USA 1-408-601-1000

21

Компания «Океан Электроники» предлагает заключение долгосрочных отношений при поставках импортных электронных компонентов на взаимовыгодных условиях!

Наши преимущества:

- Поставка оригинальных импортных электронных компонентов напрямую с производств Америки, Европы и Азии, а так же с крупнейших складов мира;
- Широкая линейка поставок активных и пассивных импортных электронных компонентов (более 30 млн. наименований);
- Поставка сложных, дефицитных, либо снятых с производства позиций;
- Оперативные сроки поставки под заказ (от 5 рабочих дней);
- Экспресс доставка в любую точку России;
- Помощь Конструкторского Отдела и консультации квалифицированных инженеров;
- Техническая поддержка проекта, помощь в подборе аналогов, поставка прототипов;
- Поставка электронных компонентов под контролем ВП;
- Система менеджмента качества сертифицирована по Международному стандарту ISO 9001;
- При необходимости вся продукция военного и аэрокосмического назначения проходит испытания и сертификацию в лаборатории (по согласованию с заказчиком);
- Поставка специализированных компонентов военного и аэрокосмического уровня качества (Xilinx, Altera, Analog Devices, Intersil, Interpoint, Microsemi, Actel, Aeroflex, Peregrine, VPT, Syfer, Eurofarad, Texas Instruments, MS Kennedy, Miteq, Cobham, E2V, MA-COM, Hittite, Mini-Circuits, General Dynamics и др.);

Компания «Океан Электроники» является официальным дистрибьютором и эксклюзивным представителем в России одного из крупнейших производителей разъемов военного и аэрокосмического назначения «JONHON», а так же официальным дистрибьютором и эксклюзивным представителем в России производителя высокотехнологичных и надежных решений для передачи СВЧ сигналов «FORSTAR».



JONHON

«JONHON» (основан в 1970 г.)

Разъемы специального, военного и аэрокосмического назначения:

(Применяются в военной, авиационной, аэрокосмической, морской, железнодорожной, горно- и нефтедобывающей отраслях промышленности)

«FORSTAR» (основан в 1998 г.)

ВЧ соединители, коаксиальные кабели, кабельные сборки и микроволновые компоненты:

(Применяются в телекоммуникациях гражданского и специального назначения, в средствах связи, РЛС, а так же военной, авиационной и аэрокосмической отраслях промышленности).



Телефон: 8 (812) 309-75-97 (многоканальный)

Факс: 8 (812) 320-03-32

Электронная почта: ocean@oceanchips.ru

Web: <http://oceanchips.ru/>

Адрес: 198099, г. Санкт-Петербург, ул. Калинина, д. 2, корп. 4, лит. А