

**BIPOLAR ANALOG INTEGRATED CIRCUIT**  
 **$\mu$ PC8178TK****SILICON MMIC LOW CURRENT AMPLIFIER  
FOR MOBILE COMMUNICATIONS****DESCRIPTION**

The  $\mu$ PC8178TK is a silicon monolithic integrated circuit designed as amplifier for mobile communications. This IC can realize low current consumption with external chip inductor which can not be realized on internal 50  $\Omega$  wide band matched IC.  $\mu$ PC8178TK adopts 6-pin lead-less minimold package using same chip as the conventional  $\mu$ PC8178TB in 6-pin super minimold.

TK suffix IC which is smaller package than TB suffix IC contributes to reduce mounting space by 50 %.

This IC is manufactured using our 30 GHz  $f_{max}$  UHS0 (Ultra High Speed Process) silicon bipolar process.

**FEATURES**

- Low current consumption :  $I_{CC} = 1.9$  mA TYP. @  $V_{CC} = 3.0$  V
- Supply voltage :  $V_{CC} = 2.4$  to 3.3 V
- Excellent isolation : ISL = 40 dB TYP. @  $f = 1.0$  GHz  
ISL = 41 dB TYP. @  $f = 1.9$  GHz  
ISL = 42 dB TYP. @  $f = 2.4$  GHz
- Power gain :  $G_P = 11.0$  dB TYP. @  $f = 1.0$  GHz  
 $G_P = 11.0$  dB TYP. @  $f = 1.9$  GHz  
 $G_P = 11.0$  dB TYP. @  $f = 2.4$  GHz
- Gain 1 dB compression output power :  $P_{O(1\text{ dB})} = -5.5$  dBm TYP. @  $f = 1.0$  GHz  
 $P_{O(1\text{ dB})} = -8.0$  dBm TYP. @  $f = 1.9$  GHz  
 $P_{O(1\text{ dB})} = -8.0$  dBm TYP. @  $f = 2.4$  GHz
- Operating frequency : 0.1 to 2.4 GHz (Output port LC matching)
- High-density surface mounting : 6-pin lead-less minimold package (1.5  $\times$  1.3  $\times$  0.55 mm)
- Light weight : 3 mg (Standard value)

**APPLICAION**

- Buffer amplifiers on 0.1 to 2.4 GHz mobile communications system

**Caution** Observe precautions when handling because these devices are sensitive to electrostatic discharge.

The information in this document is subject to change without notice. Before using this document, please confirm that this is the latest version.  
Not all devices/types available in every country. Please check with local NEC Compound Semiconductor Devices representative for availability and additional information.

★ ORDERING INFORMATION

Part Number	Order Number	Package	Marking	Supplying Form
μPC8178TK-E2	μPC8178TK-E2-A	6-pin lead-less minimold (1511) (Pb-Free) <sup>Note</sup>	6B	<ul style="list-style-type: none"> <li>• Embossed tape 8 mm wide</li> <li>• Pin 1, 2, 3 face the perforation side of the tape</li> <li>• Qty 5 kpcs/reel</li> </ul>

**Note** With regards to terminal solder (the solder contains lead) plated products (conventionally plated), contact your nearby sales office.

**Remark** To order evaluation samples, contact your nearby sales office.  
Part number for sample order: μPC8178TK

**PRODUCT LINE-UP (T<sub>A</sub> = +25°C, V<sub>CC</sub> = V<sub>out</sub> = 3.0 V, Z<sub>S</sub> = Z<sub>L</sub> = 50 Ω)**

Parameter Part No.	I <sub>CC</sub> (mA)	1.0 GHz output port matching frequency			1.66 GHz output port matching frequency			1.9 GHz output port matching frequency			2.4 GHz output port matching frequency			Marking
		G <sub>P</sub> (dB)	ISL (dB)	P <sub>O(1dB)</sub> (dBm)	G <sub>P</sub> (dB)	ISL (dB)	P <sub>O(1dB)</sub> (dBm)	G <sub>P</sub> (dB)	ISL (dB)	P <sub>O(1dB)</sub> (dBm)	G <sub>P</sub> (dB)	ISL (dB)	P <sub>O(1dB)</sub> (dBm)	
μPC8178TB	1.9	11.0	39.0	-4.0	-	-	-	11.5	40.0	-7.0	11.5	38.0	-7.5	C3B
μPC8178TK	1.9	11.0	40.0	-5.5	-	-	-	11.0	41.0	-8.0	11.0	42.0	-8.0	6B
μPC8179TB	4.0	13.5	44.0	+3.0	-	-	-	15.5	42.0	+1.5	15.5	41.0	+1.0	C3C
μPC8128TB	2.8	12.5	39.0	-4.0	13.0	39.0	-4.0	13.0	37.0	-4.0	-	-	-	C2P
μPC8151TB	4.2	12.5	38.0	+2.5	15.0	36.0	+1.5	15.0	34.0	+0.5	-	-	-	C2U
μPC8152TB	5.6	23.0	40.0	-4.5	19.5	38.0	-8.5	17.5	35.0	-8.5	-	-	-	C2V

**Remarks** 1. Typical performance. Please refer to **ELECTRICAL CHARACTERISTICS** in detail.  
2. To know the associated product, please refer to each latest data sheet.

SYSTEM APPLICATION EXAMPLE

Location examples in digital cellular

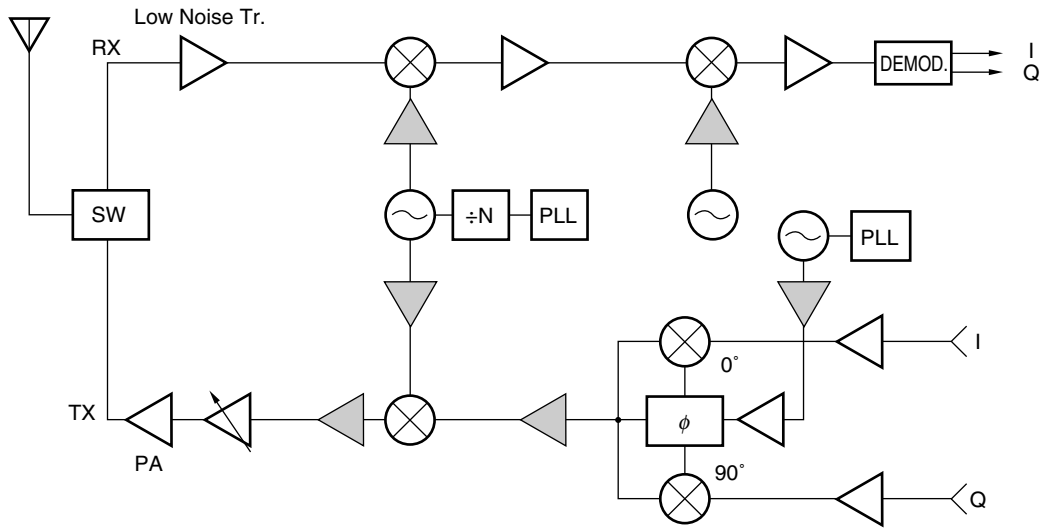

These ICs can be added to your system around  $\triangle$  parts, when you need more isolation or gain. The application herein, however, shows only examples, therefore the application can depend on your kit evaluation.

**PIN CONNECTIONS**

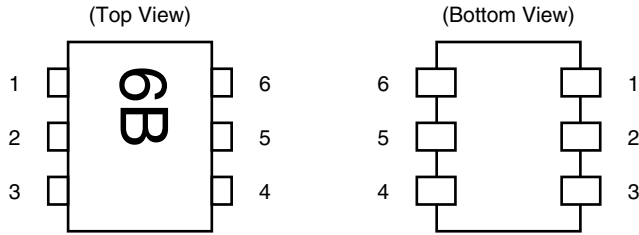

Pin No.	Pin Name
1	INPUT
2	GND
3	GND
4	OUTPUT
5	GND
6	V <sub>CC</sub>

**PIN EXPLANATION**

Pin No.	Pin Name	Applied Voltage (V)	Pin Voltage (V) <sup>Note</sup>	Function and Applications	Internal Equivalent Circuit
1	INPUT	–	0.90	Signal input pin. A internal matching circuit, configured with resistors, enables 50 Ω connection over a wide band. This pin must be coupled to signal source with capacitor for DC cut.	
2 3 5	GND	0	–	Ground pin. This pin should be connected to system ground with minimum inductance. Ground pattern on the board should be formed as wide as possible. All the ground pins must be connected together with wide ground pattern to decrease impedance difference.	
4	OUTPUT	Voltage as same as V <sub>CC</sub> through external inductor	–	Signal output pin. This pin is designed as collector output. Due to the high impedance output, this pin should be externally equipped with LC matching circuit to next stage. For L, a size 1 005 chip inductor can be chosen.	
6	V <sub>CC</sub>	2.4 to 3.3	–	Power supply pin. This pin should be externally equipped with bypass capacitor to minimize its impedance.	

**Note** Pin voltage is measured at V<sub>CC</sub> = 3.0 V.

**ABSOLUTE MAXIMUM RATINGS**

Parameter	Symbol	Test Conditions	Ratings	Unit
Supply Voltage	V <sub>CC</sub>	T <sub>A</sub> = +25°C, Pin 4, Pin 6	3.6	V
Circuit Current	I <sub>CC</sub>	T <sub>A</sub> = +25°C	15	mA
Power Dissipation	P <sub>D</sub>	T <sub>A</sub> = +85°C <b>Note</b>	232	mW
Operating Ambient Temperature	T <sub>A</sub>		-40 to +85	°C
Storage Temperature	T <sub>stg</sub>		-55 to +150	°C
Input Power	P <sub>in</sub>	T <sub>A</sub> = +25°C	+5	dBm

**Note** Mounted on double-sided copper-clad 50 × 50 × 1.6 mm epoxy glass PWB

**RECOMMENDED OPERATING RANGE**

Parameter	Symbol	MIN.	TYP.	MAX.	Unit	Remarks
Supply Voltage	V <sub>CC</sub>	2.4	3.0	3.3	V	The same voltage should be applied to pin 4 and pin 6.
Operating Ambient Temperature	T <sub>A</sub>	-40	+25	+85	°C	

**ELECTRICAL CHARACTERISTICS**

(Unless otherwise specified, T<sub>A</sub> = +25°C, V<sub>CC</sub> = V<sub>out</sub> = 3.0 V, Z<sub>s</sub> = Z<sub>L</sub> = 50 Ω, at LC matched frequency)

Parameter	Symbol	Test Conditions	MIN.	TYP.	MAX.	Unit
Circuit Current	I <sub>CC</sub>	No signal	1.4	1.9	2.4	mA
Power Gain	G <sub>P</sub>	f = 1.0 GHz, P <sub>in</sub> = -30 dBm f = 1.9 GHz, P <sub>in</sub> = -30 dBm f = 2.4 GHz, P <sub>in</sub> = -30 dBm	9.0 9.0 9.0	11.0 11.0 11.0	13.0 13.5 13.5	dB
Isolation	ISL	f = 1.0 GHz, P <sub>in</sub> = -30 dBm f = 1.9 GHz, P <sub>in</sub> = -30 dBm f = 2.4 GHz, P <sub>in</sub> = -30 dBm	35.0 36.0 37.0	40.0 41.0 42.0	- - -	dB
Gain 1 dB Compression Output Power	P <sub>O(1 dB)</sub>	f = 1.0 GHz f = 1.9 GHz f = 2.4 GHz	-8.0 -11.0 -11.5	-5.5 -8.0 -8.0	- - -	dBm
Noise Figure	NF	f = 1.0 GHz f = 1.9 GHz f = 2.4 GHz	- - -	5.5 5.5 5.5	7.0 7.0 7.0	dB
Input Return Loss	RL <sub>in</sub>	f = 1.0 GHz, P <sub>in</sub> = -30 dBm f = 1.9 GHz, P <sub>in</sub> = -30 dBm f = 2.4 GHz, P <sub>in</sub> = -30 dBm	4.0 5.0 6.5	7.0 8.0 9.5	- - -	dB

★ TEST CIRCUITS

<1>  $f = 1.0 \text{ GHz}$

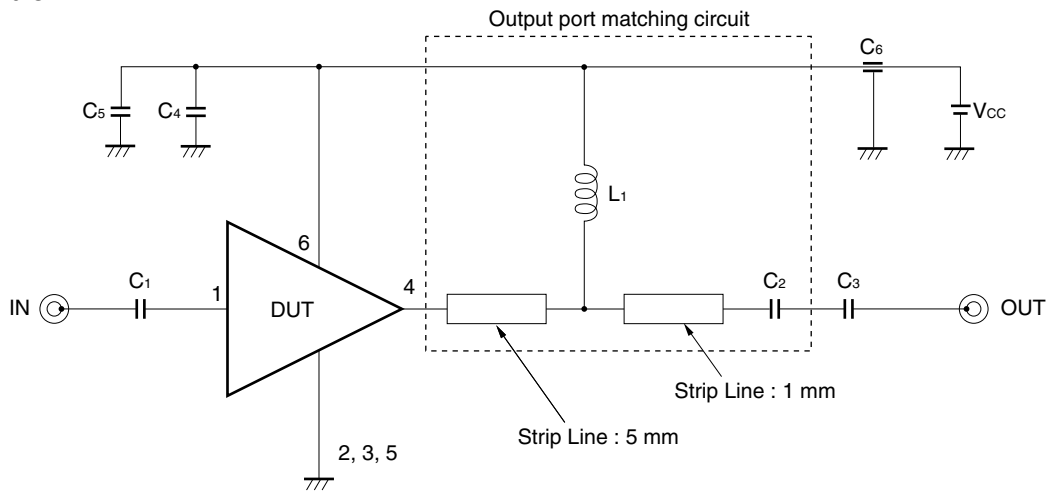

<2>  $f = 1.9 \text{ GHz}$

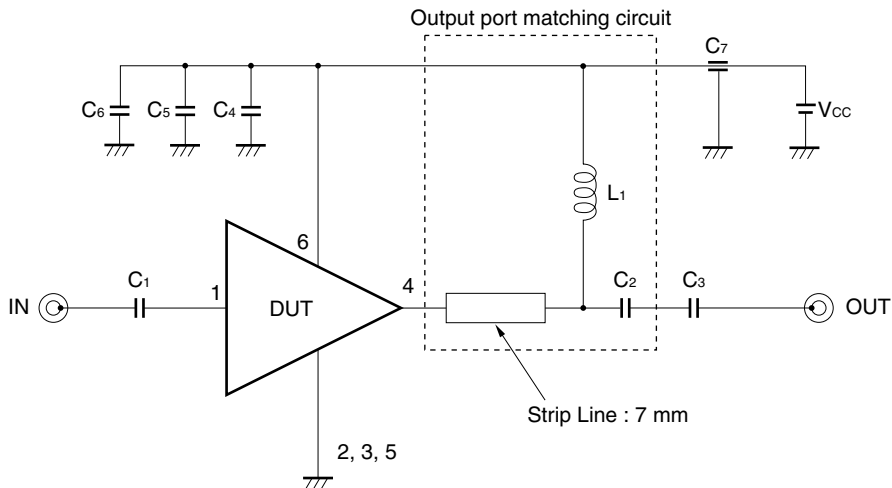

<3>  $f = 2.4 \text{ GHz}$

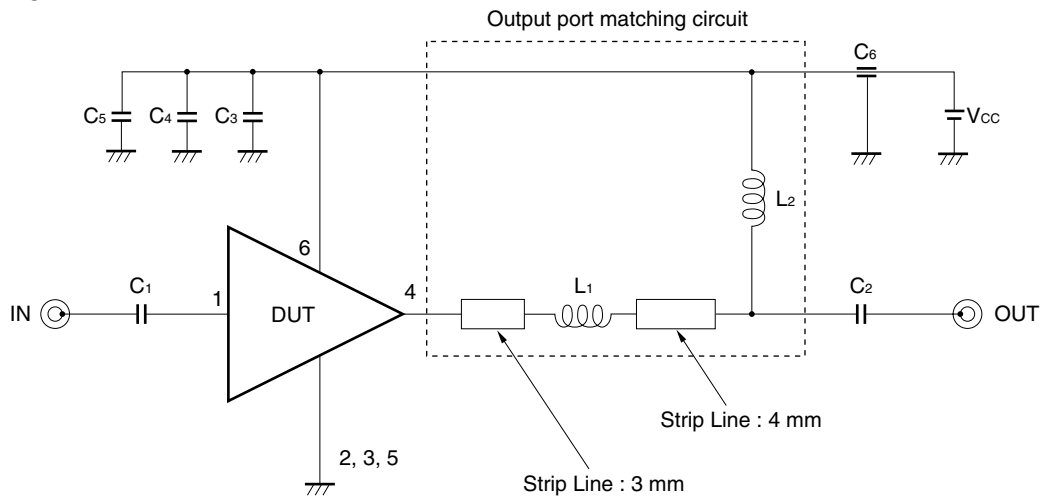

★ ILLUSTRATION OF THE TEST CIRCUIT ASSEMBLED ON EVALUATION BOARD

<1> f = 1.0 GHz

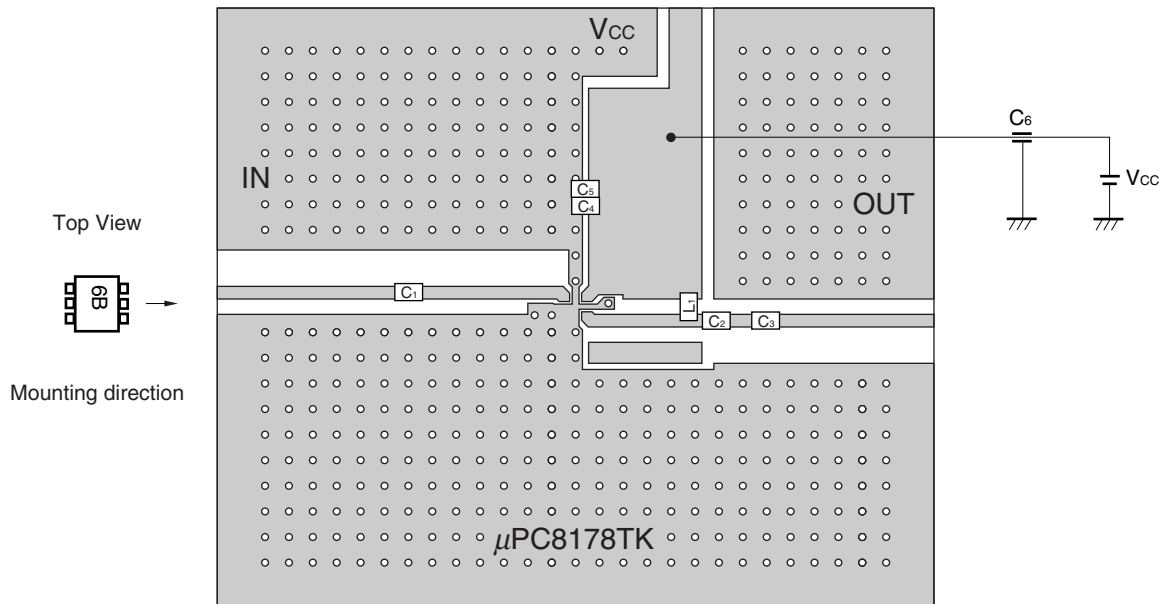

- (\*1) 42 × 35 × 0.4 mm polyimide board, double-sided copper clad
- (\*2) Back side: GND pattern
- (\*3) Gold plated on pattern
- (\*4) o : Through holes

COMPONENT LIST

Form	Symbol	Value	Type code	Maker
Chip capacitor	C1, C3	1 000 pF	GRM40CH102J50PT	murata
	C2	0.75 pF	GRM39CKR75C50PT	murata
	C4	20 pF	GRM39CH200J50PT	murata
	C5	10 pF	GRM39CH100D50PT	murata
Feed-through Capacitor	C6	1 000 pF	DFT301-801 × 7R102S50	murata
Chip inductor	L1	12 nH	LL1608-FH12N	TOKO

<2> f = 1.9 GHz

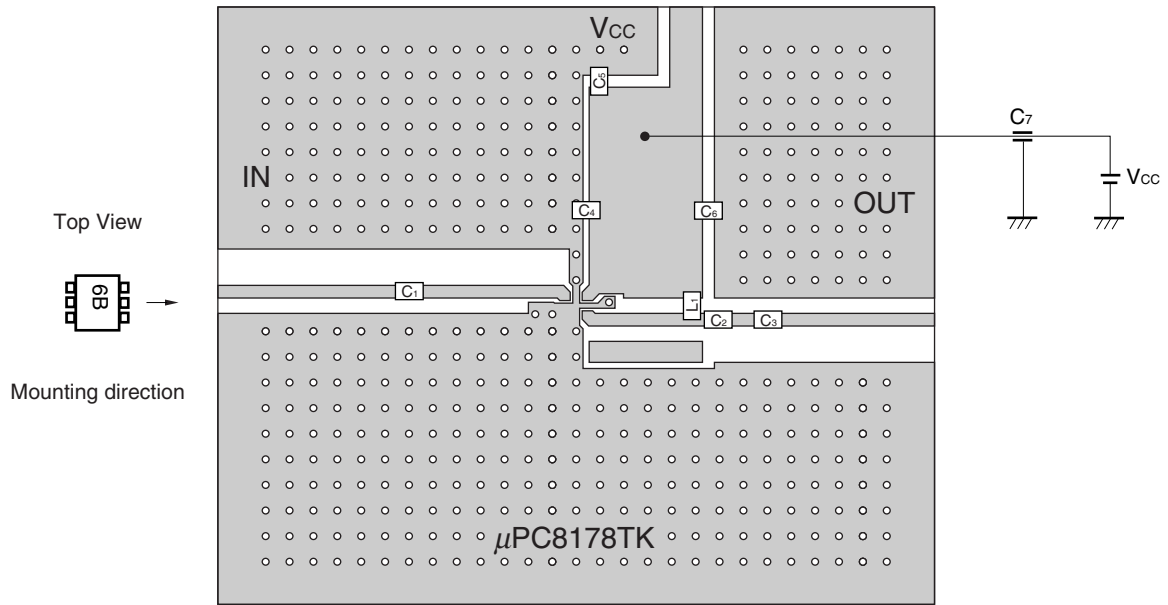

- (\*1) 42 × 35 × 0.4 mm polyimide board, double-sided copper clad
- (\*2) Back side: GND pattern
- (\*3) Gold plated on pattern
- (\*4) o : Through holes

**COMPONENT LIST**

Form	Symbol	Value	Type code	Maker
Chip capacitor	C <sub>1</sub> , C <sub>3</sub> , C <sub>5</sub> , C <sub>6</sub>	1 000 pF	GRM40CH102J50PT	murata
	C <sub>2</sub>	0.5 pF	GRM39CKR5C50PT	murata
	C <sub>4</sub>	8 pF	GRM39CH080D50PT	murata
Feed-through Capacitor	C <sub>7</sub>	1 000 pF	DFT301-801 × 7R102S50	murata
Chip inductor	L <sub>1</sub>	2.7 nH	LL1608-FH2N7S	TOKO



<3> f = 2.4 GHz

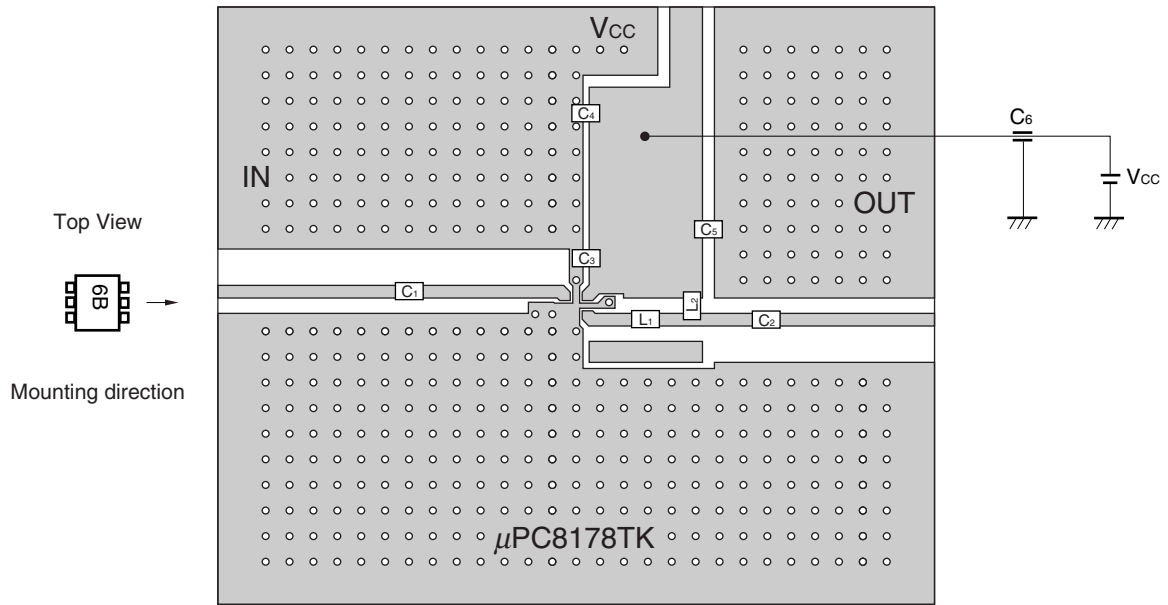

- (\*1) 42 × 35 × 0.4 mm polyimide board, double-sided copper clad
- (\*2) Back side: GND pattern
- (\*3) Gold plated on pattern
- (\*4) o : Through holes

**COMPONENT LIST**

Form	Symbol	Value	Type code	Maker
Chip capacitor	C <sub>1</sub> , C <sub>2</sub> , C <sub>4</sub> , C <sub>5</sub>	1 000 pF	GRM40CH102J50PT	murata
	C <sub>3</sub>	10 pF	GRM39CH100D50PT	murata
Feed-through Capacitor	C <sub>6</sub>	1 000 pF	DFT301-801 × 7R102S50	murata
Chip inductor	L <sub>1</sub>	2.7 nH	LL1608-FH2N7S	TOKO
	L <sub>2</sub>	1.8 nH	LL1608-FH1N8S	TOKO

★ TYPICAL CHARACTERISTICS ( $T_A = +25^\circ\text{C}$ , unless otherwise specified)

CIRCUIT CURRENT vs. SUPPLY VOLTAGE

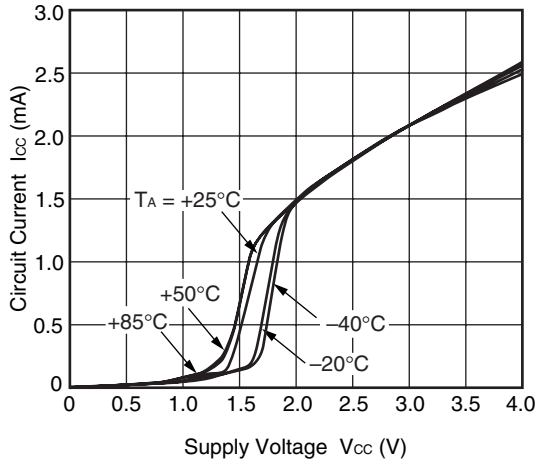

**Remark** The graph indicates nominal characteristics.

f = 1.0 GHz MATCHING

S<sub>11</sub>-FREQUENCY

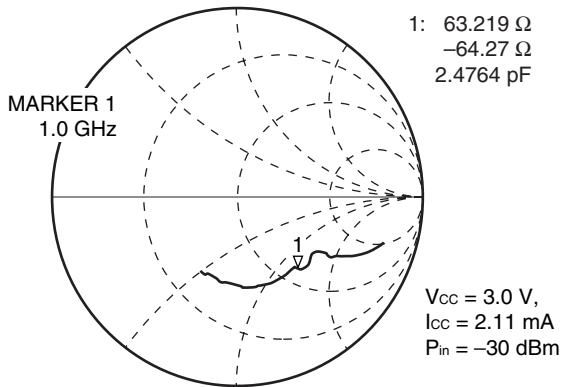

START 100.000 000 MHz STOP 3 100.000 000 MHz

S<sub>22</sub>-FREQUENCY

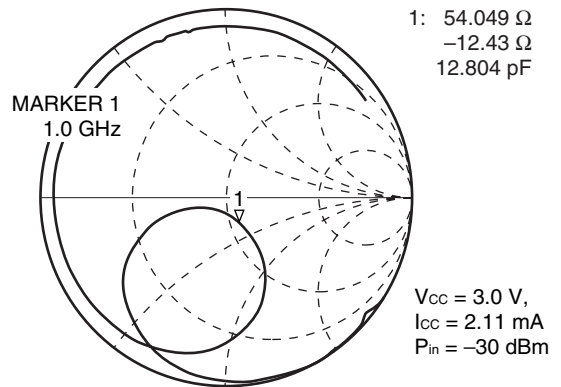

START 100.000 000 MHz STOP 3 100.000 000 MHz

S<sub>11</sub>-FREQUENCY

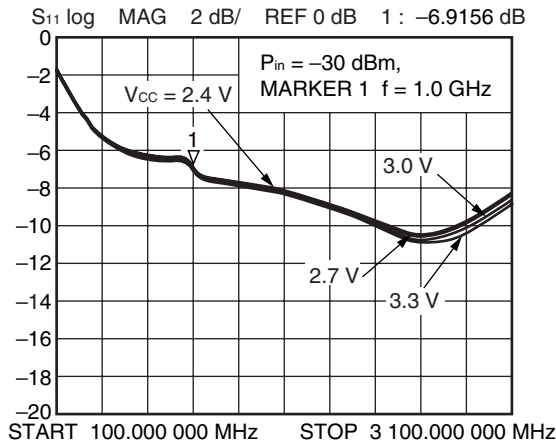

S<sub>12</sub>-FREQUENCY

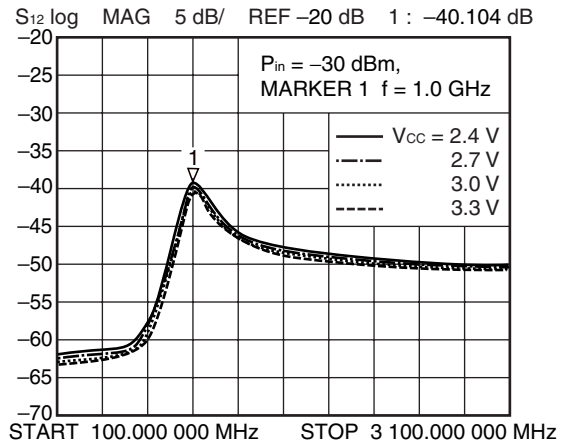

S<sub>21</sub>-FREQUENCY

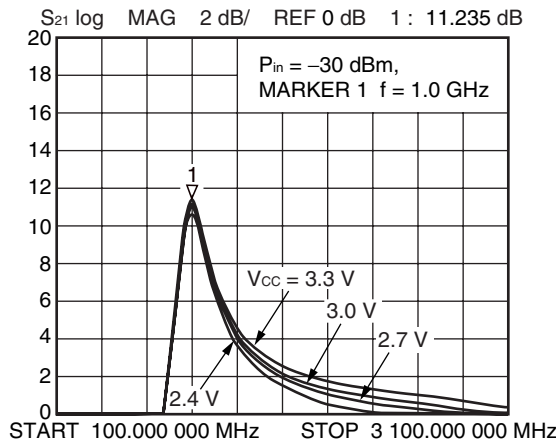

S<sub>22</sub>-FREQUENCY

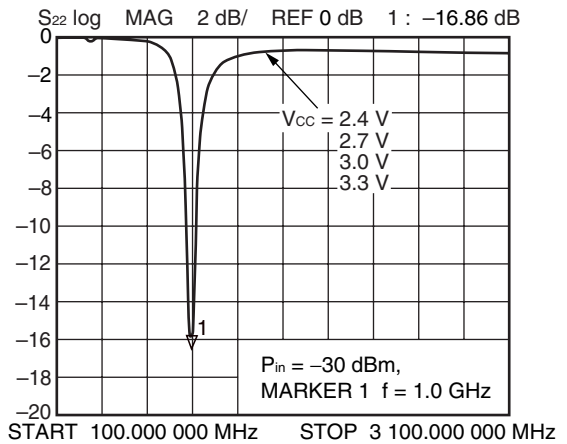

**Remark** The graphs indicate nominal characteristics.

S<sub>11</sub>-FREQUENCY

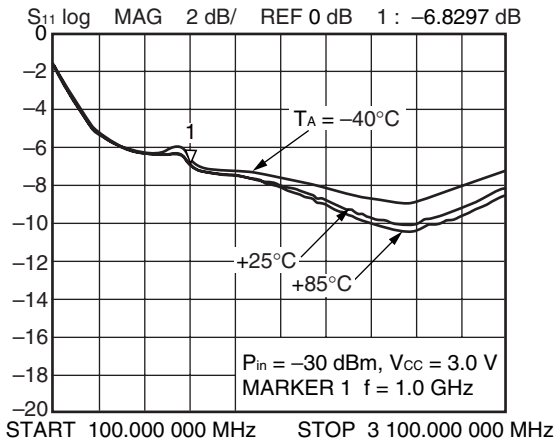

S<sub>12</sub>-FREQUENCY

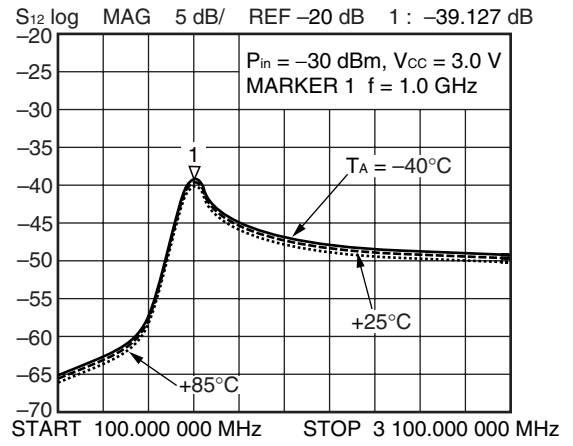

S<sub>21</sub>-FREQUENCY

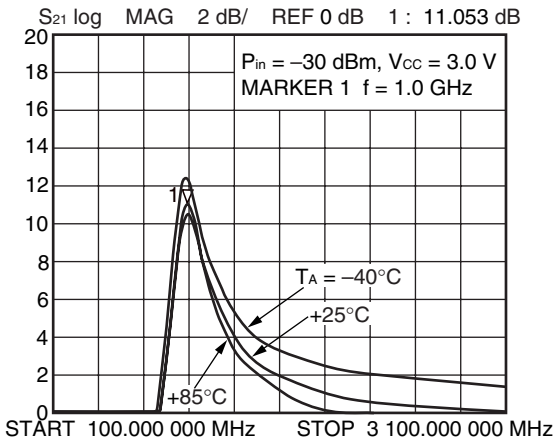

S<sub>22</sub>-FREQUENCY

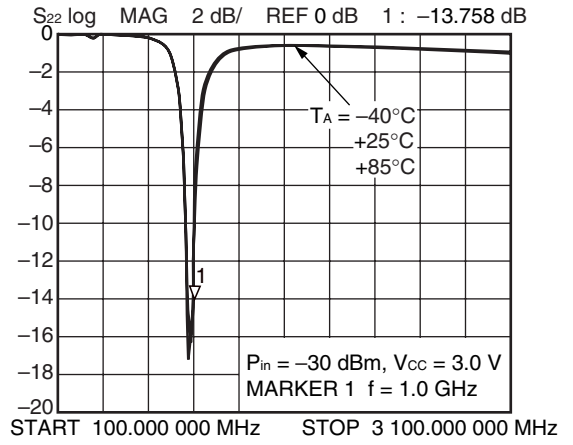

**Remark** The graphs indicate nominal characteristics.

OUTPUT POWER vs. INPUT POWER

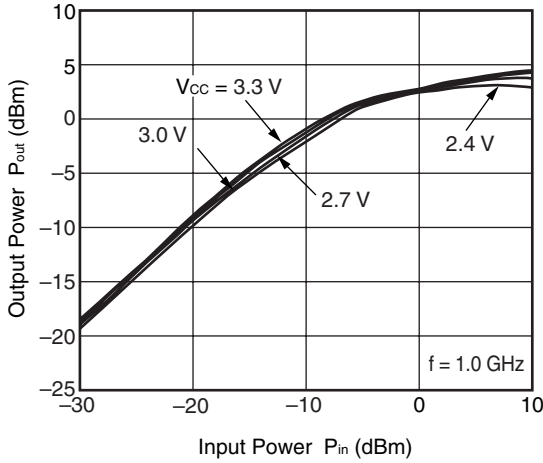

OUTPUT POWER vs. INPUT POWER

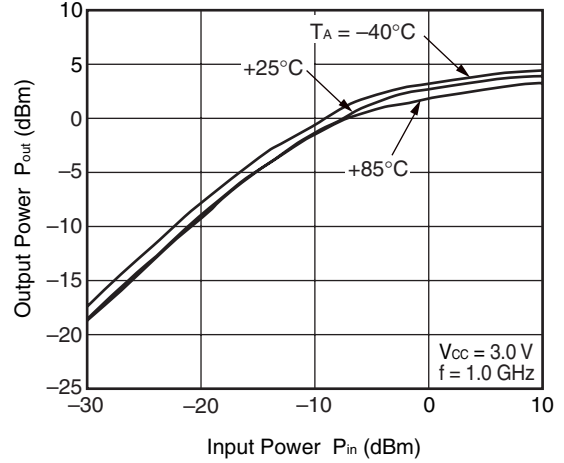

OUTPUT POWER,  $IM_3$  vs. INPUT POWER

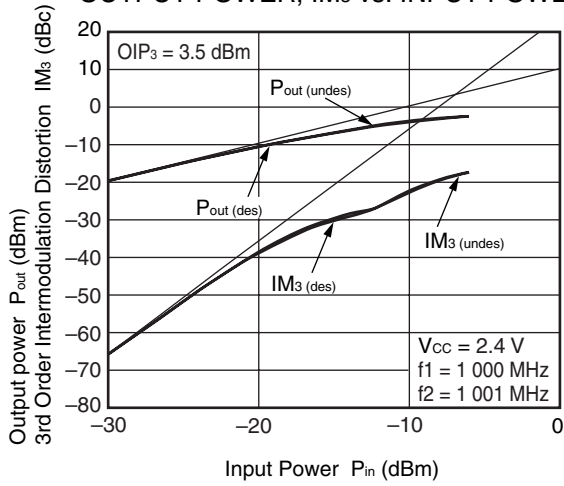

OUTPUT POWER,  $IM_3$  vs. INPUT POWER

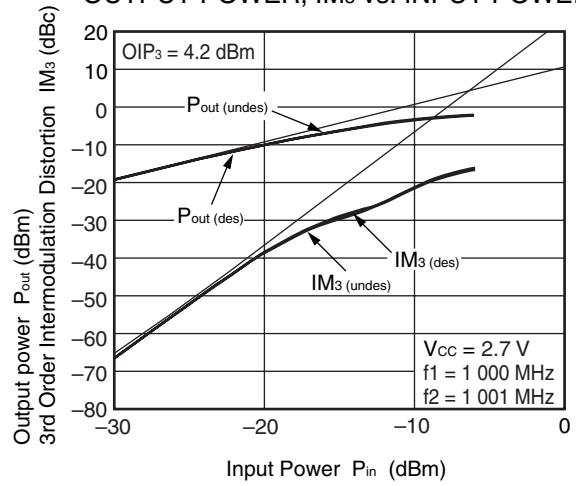

OUTPUT POWER,  $IM_3$  vs. INPUT POWER

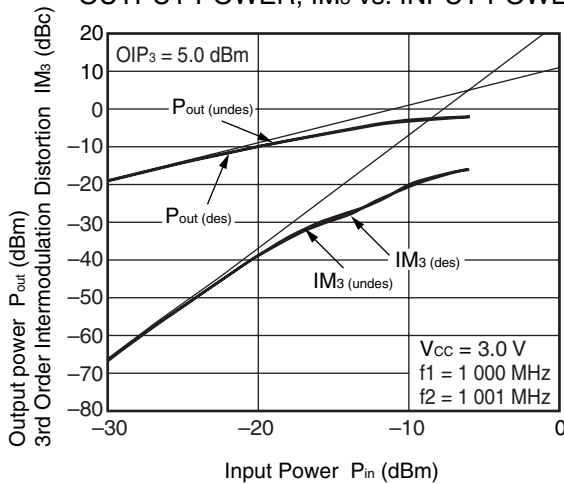

OUTPUT POWER,  $IM_3$  vs. INPUT POWER

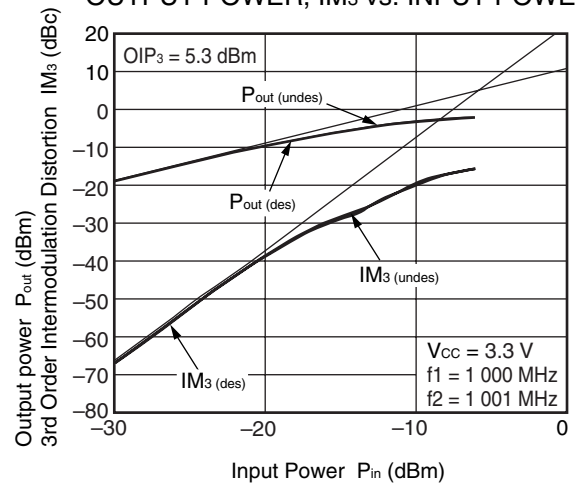

**Remark** The graphs indicate nominal characteristics.

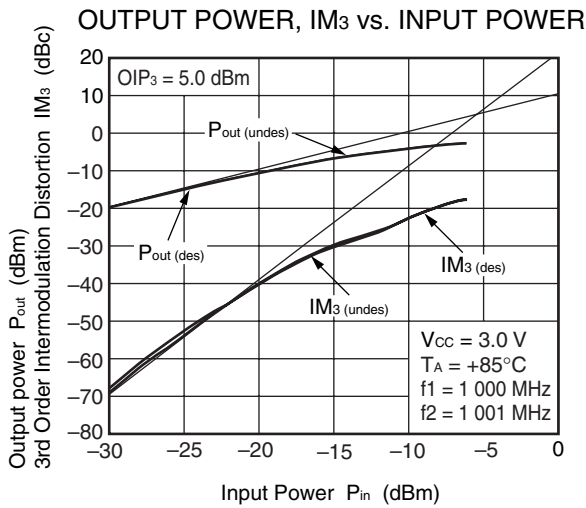
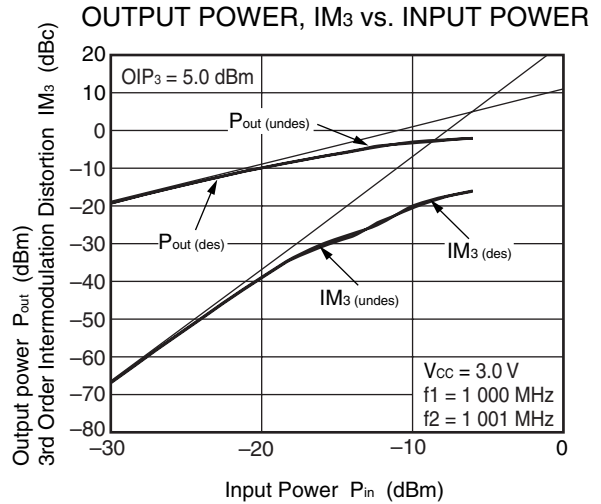
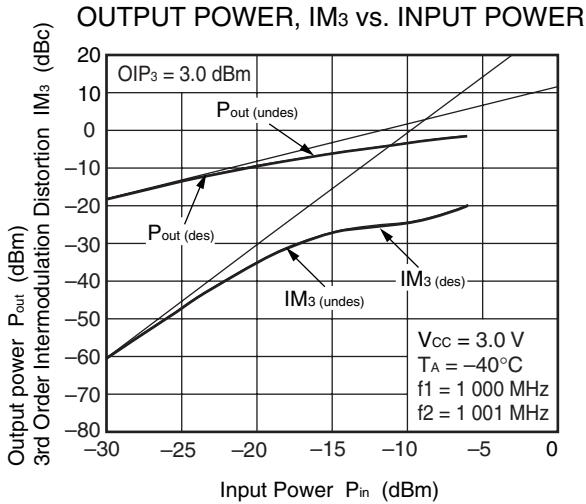

**3RD ORDER INTERMODULATION DISTORTION vs. OUTPUT POWER OF EACH TONE**

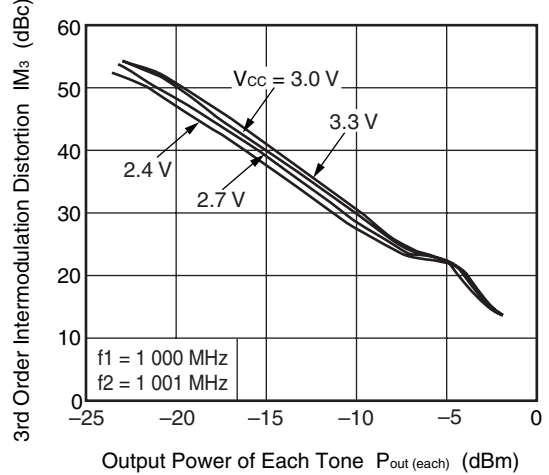

**NOISE FIGURE vs. SUPPLY VOLTAGE**

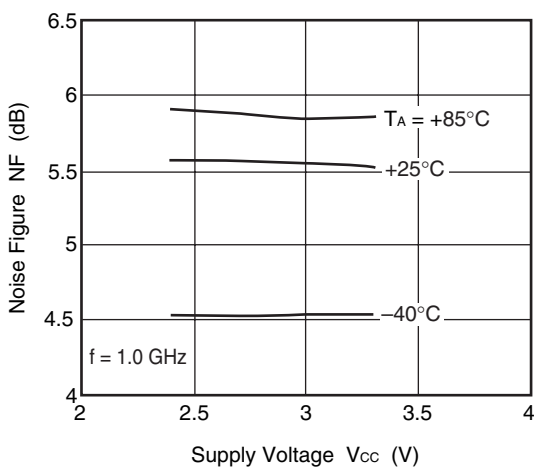

**Remark** The graphs indicate nominal characteristics.

f = 1.9 GHz MATCHING

S<sub>11</sub>-FREQUENCY

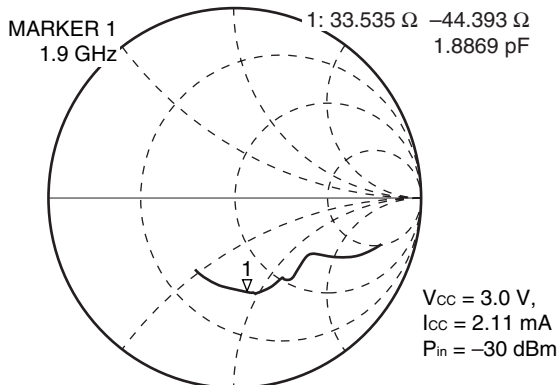

START 100.000 000 MHz STOP 3 100.000 000 MHz

S<sub>22</sub>-FREQUENCY

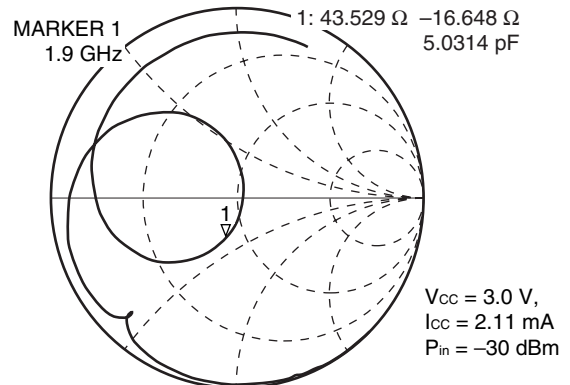

START 100.000 000 MHz STOP 3 100.000 000 MHz

S<sub>11</sub>-FREQUENCY

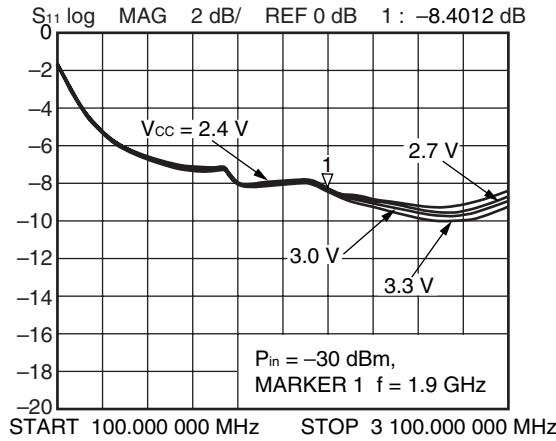

S<sub>12</sub>-FREQUENCY

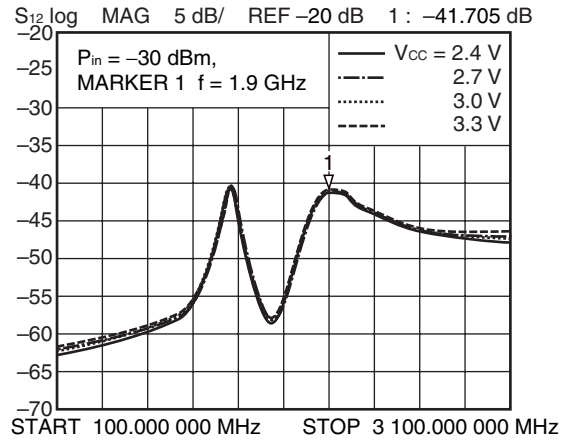

S<sub>21</sub>-FREQUENCY

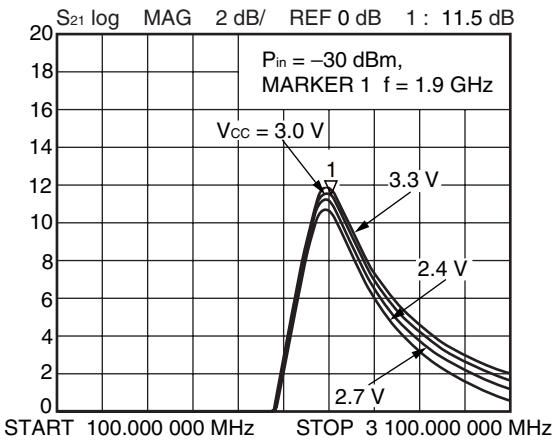

S<sub>22</sub>-FREQUENCY

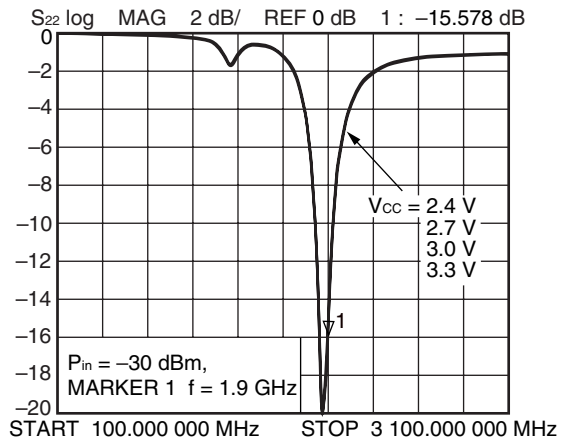

**Remark** The graphs indicate nominal characteristics.

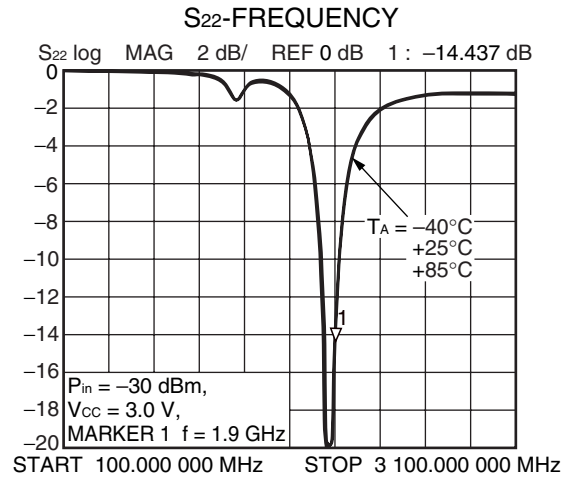
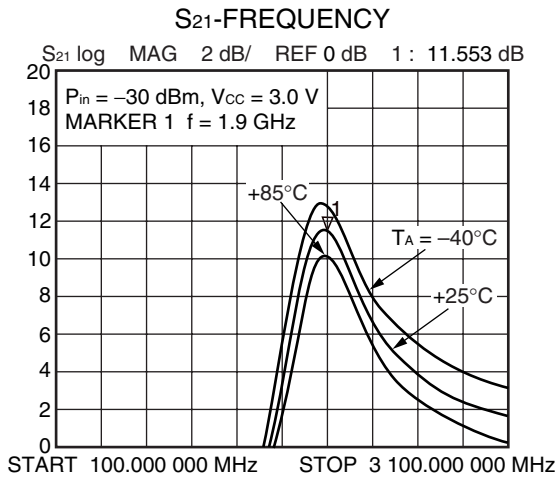
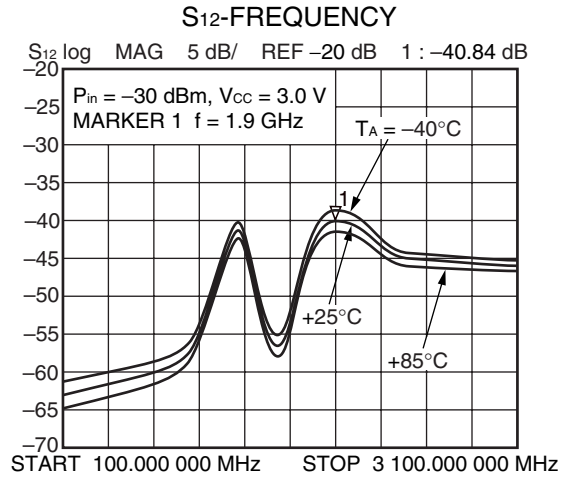
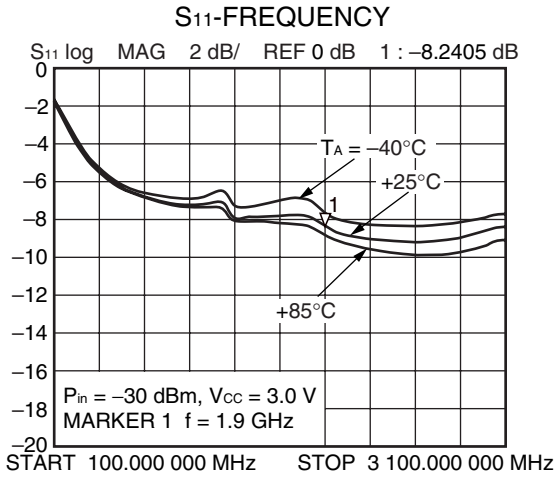

**Remark** The graphs indicate nominal characteristics.



OUTPUT POWER vs. INPUT POWER

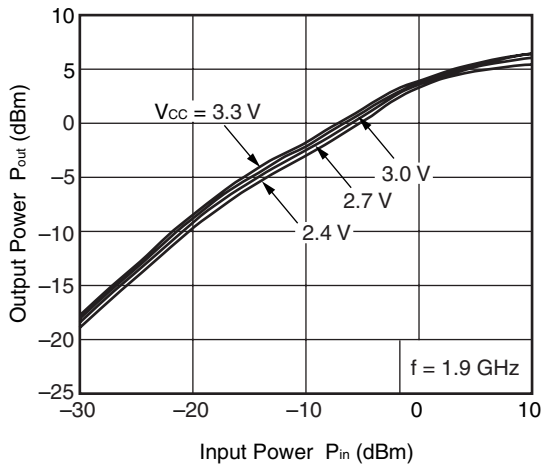

OUTPUT POWER vs. INPUT POWER

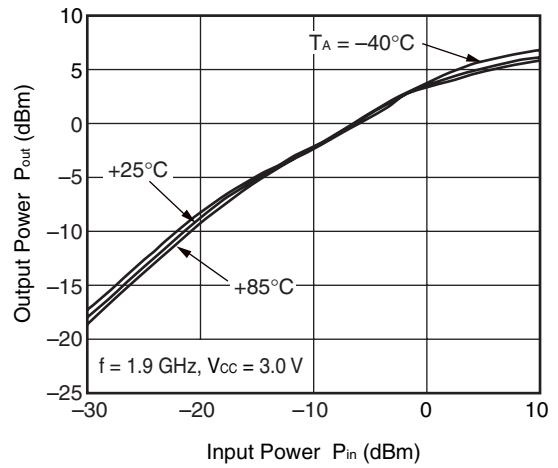

OUTPUT POWER, IM<sub>3</sub> vs. INPUT POWER

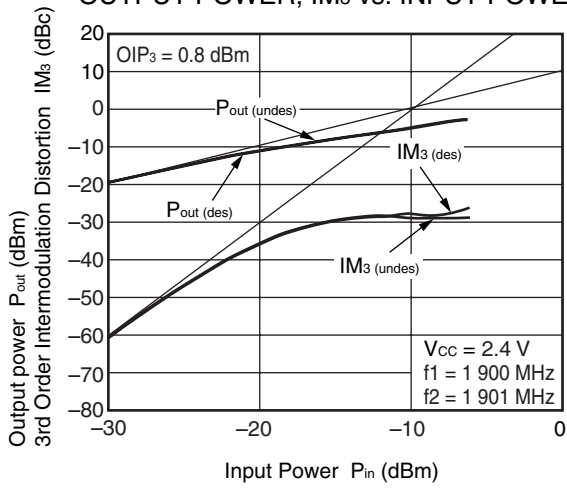

OUTPUT POWER, IM<sub>3</sub> vs. INPUT POWER

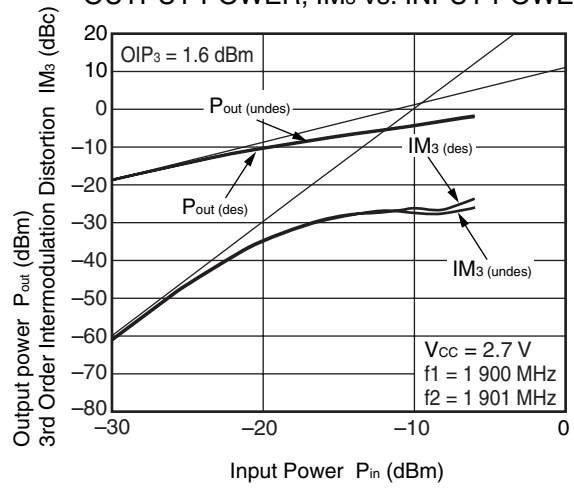

OUTPUT POWER, IM<sub>3</sub> vs. INPUT POWER

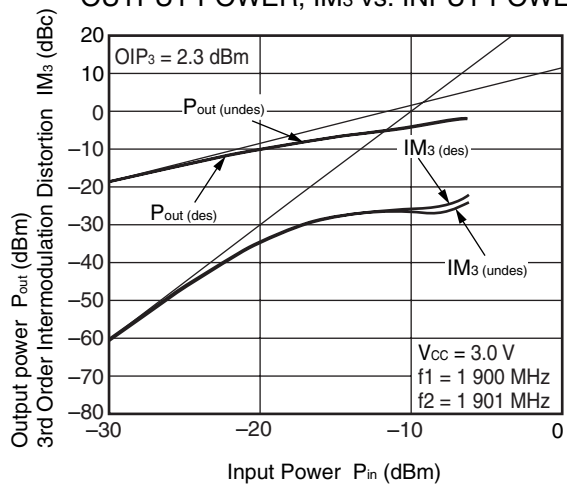

OUTPUT POWER, IM<sub>3</sub> vs. INPUT POWER

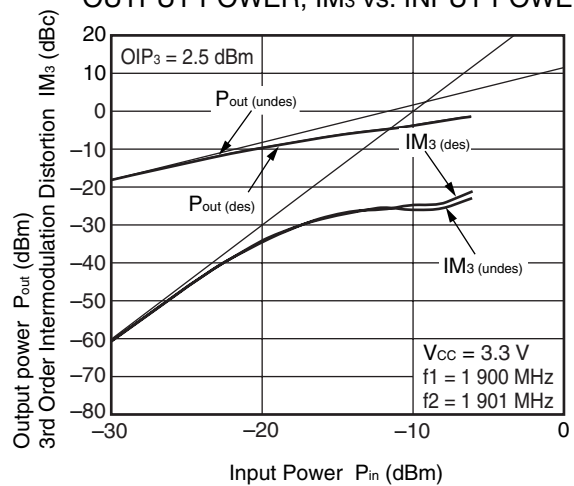

**Remark** The graphs indicate nominal characteristics.

OUTPUT POWER, IM<sub>3</sub> vs. INPUT POWER

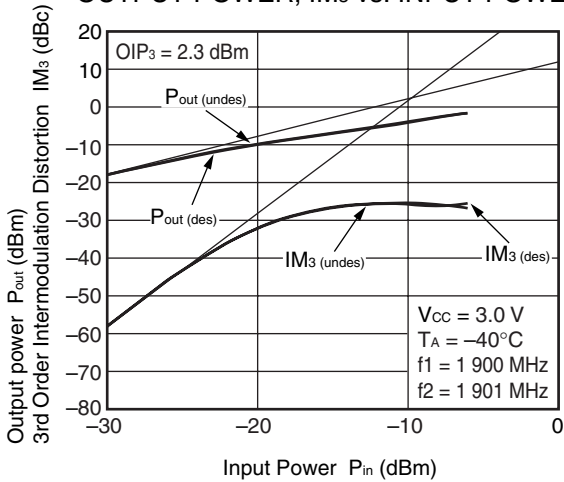

OUTPUT POWER, IM<sub>3</sub> vs. INPUT POWER

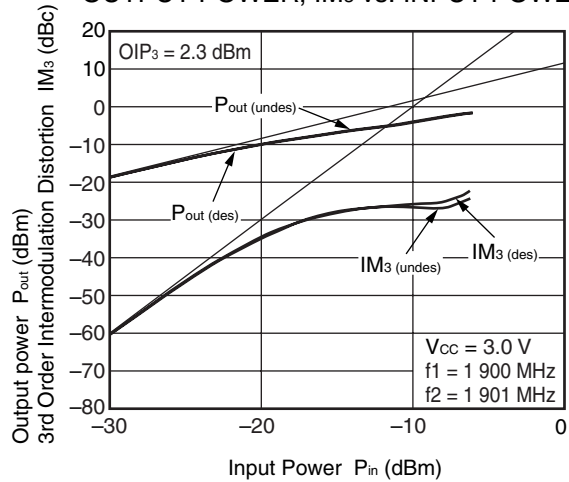

OUTPUT POWER, IM<sub>3</sub> vs. INPUT POWER

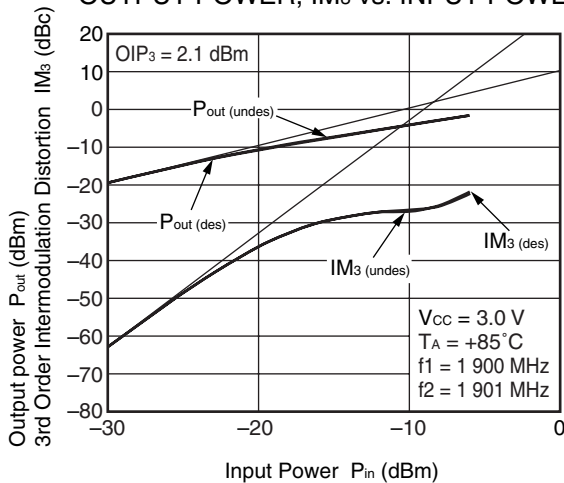

3RD ORDER INTERMODULATION DISTORTION vs. OUTPUT POWER OF EACH TONE

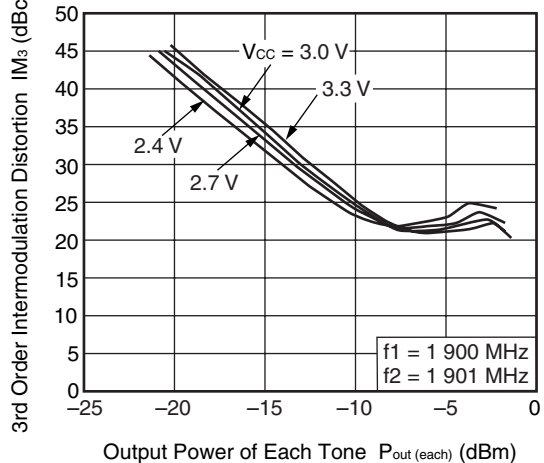

NOISE FIGURE vs. SUPPLY VOLTAGE

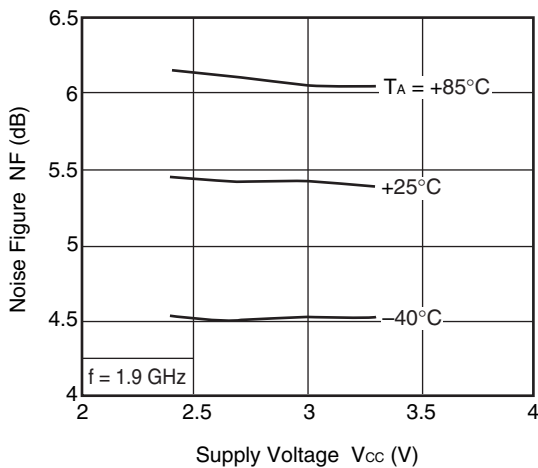

**Remark** The graphs indicate nominal characteristics.

f = 2.4 GHz MATCHING

S<sub>11</sub>-FREQUENCY

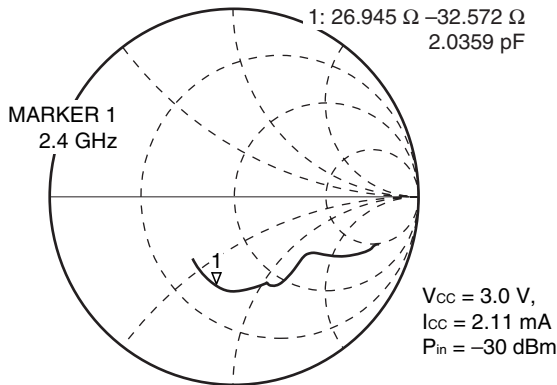

START 100.000 000 MHz STOP 3 100.000 000 MHz

S<sub>22</sub>-FREQUENCY

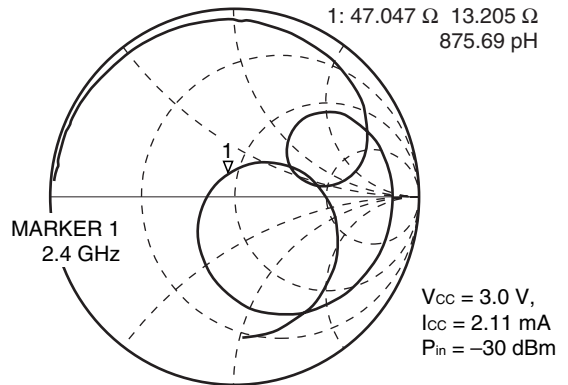

START 100.000 000 MHz STOP 3 100.000 000 MHz

S<sub>11</sub>-FREQUENCY

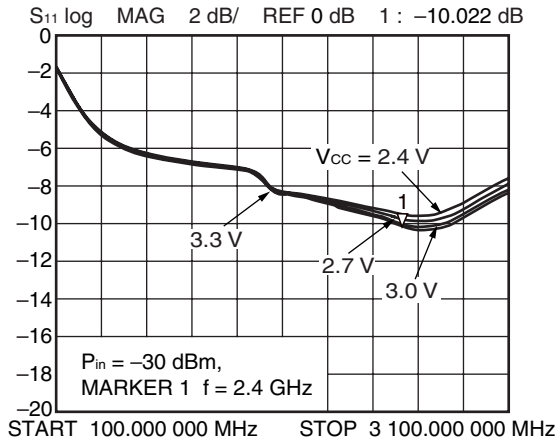

S<sub>12</sub>-FREQUENCY

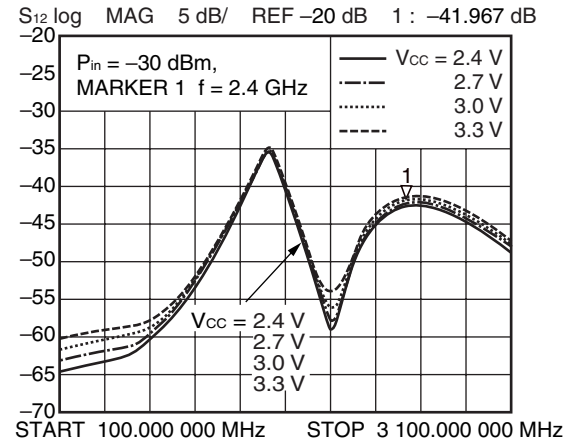

S<sub>21</sub>-FREQUENCY

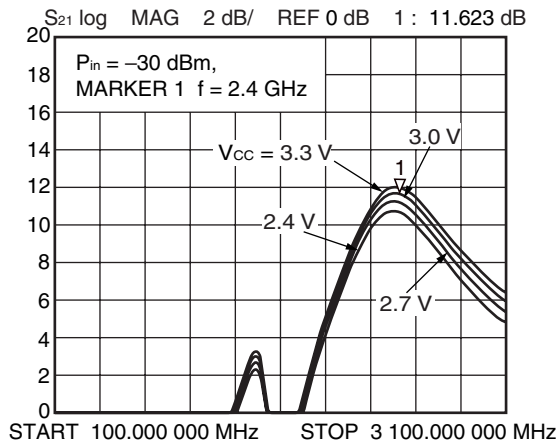

S<sub>22</sub>-FREQUENCY

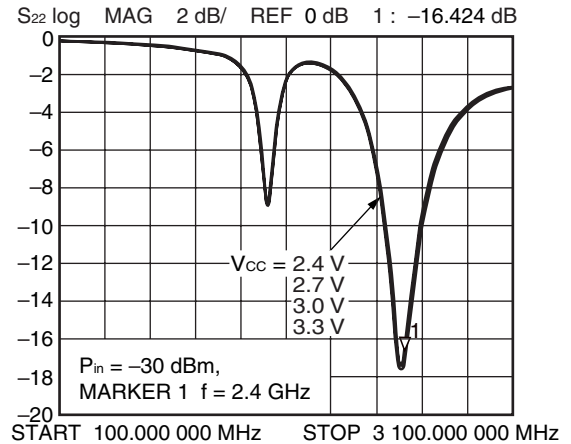

**Remark** The graphs indicate nominal characteristics.

S11-FREQUENCY

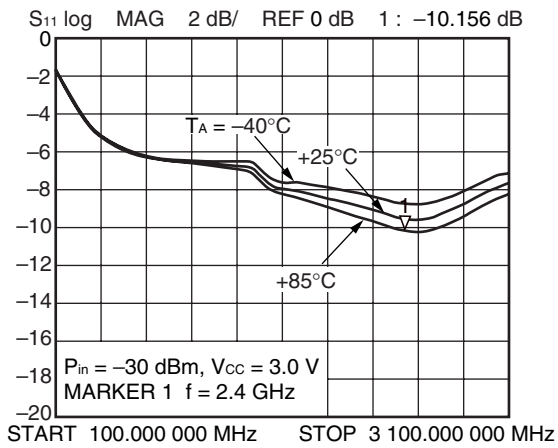

S12-FREQUENCY

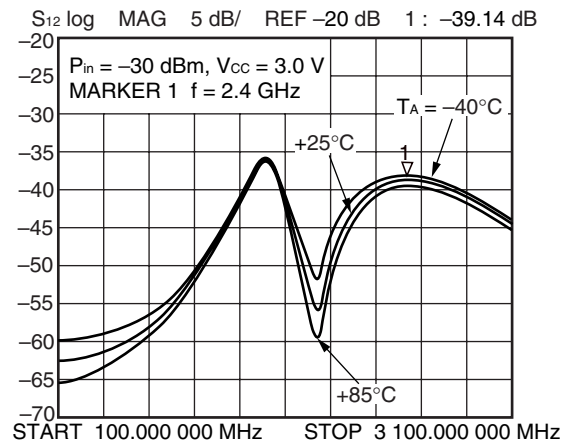

S21-FREQUENCY

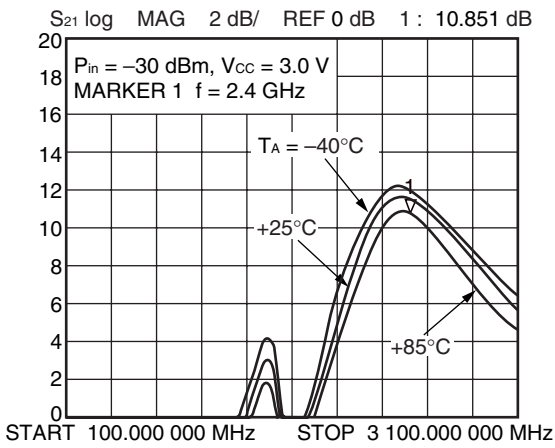

S22-FREQUENCY

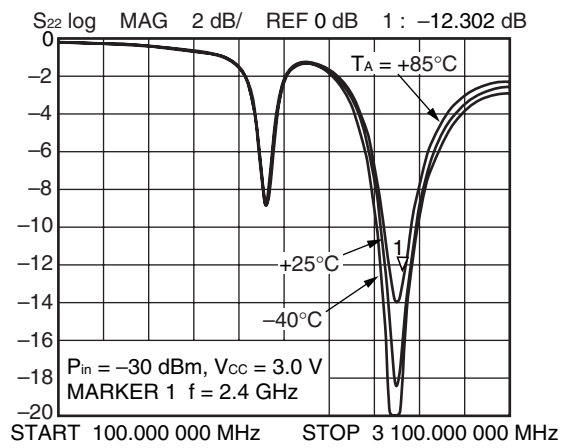

**Remark** The graphs indicate nominal characteristics.

OUTPUT POWER vs. INPUT POWER

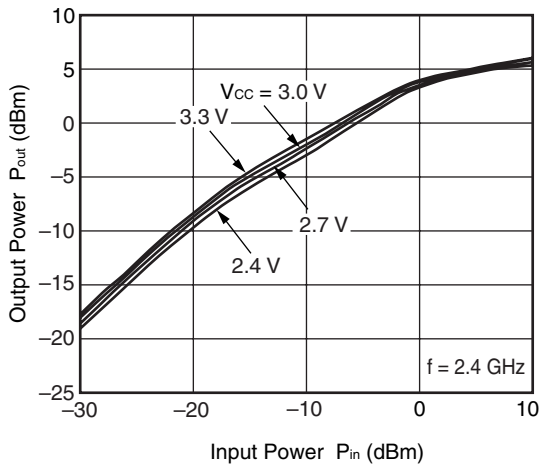

OUTPUT POWER vs. INPUT POWER

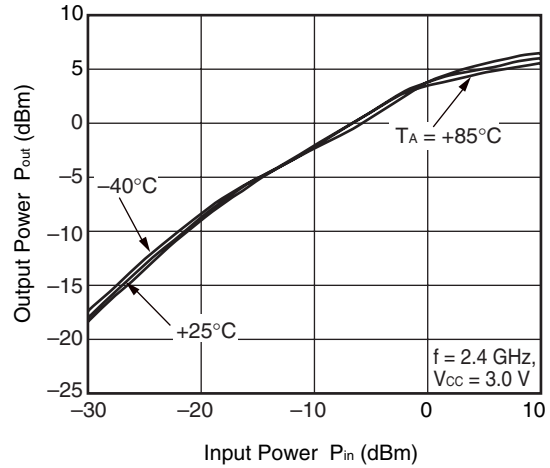

OUTPUT POWER, IM3 vs. INPUT POWER

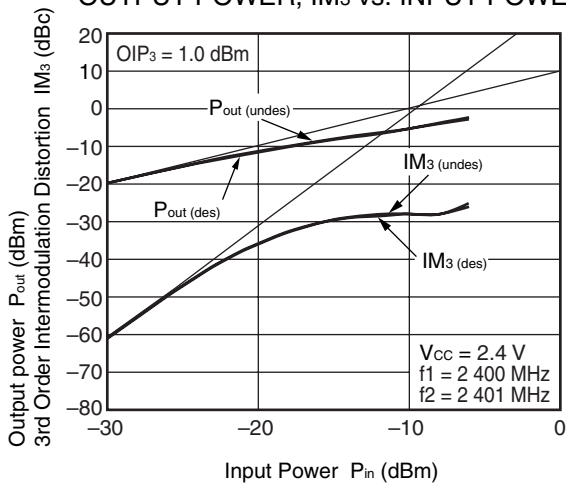

OUTPUT POWER, IM3 vs. INPUT POWER

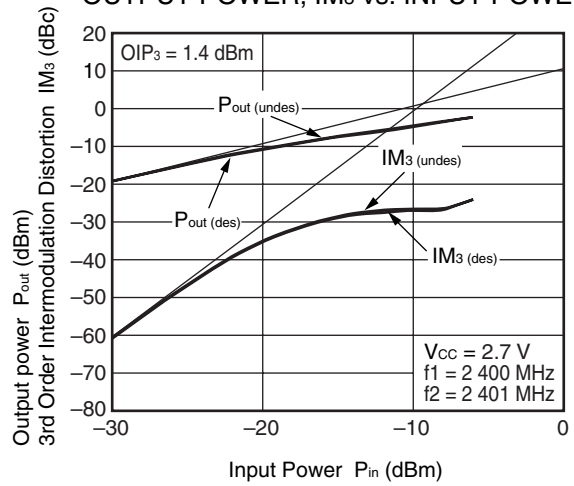

OUTPUT POWER, IM3 vs. INPUT POWER

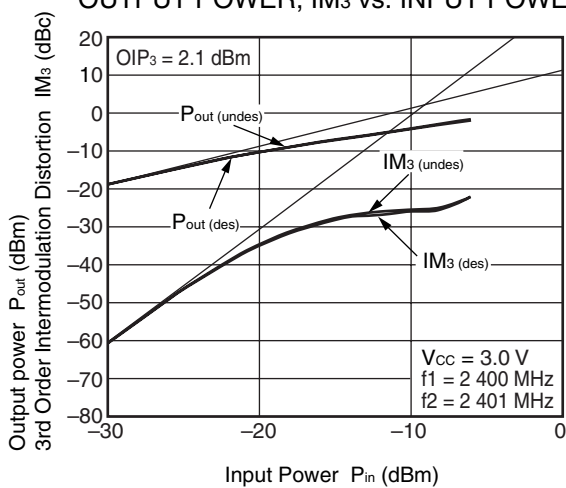

OUTPUT POWER, IM3 vs. INPUT POWER

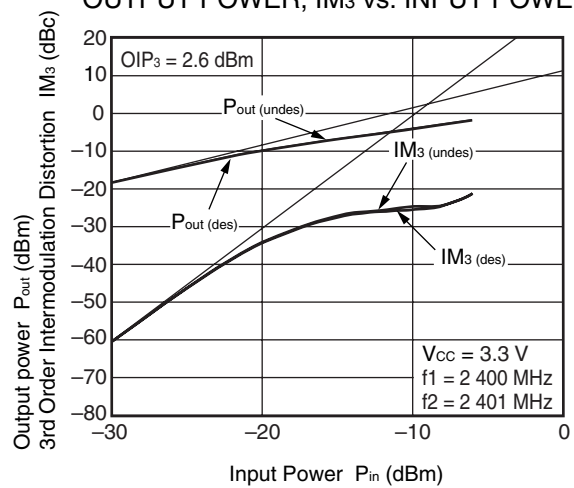

**Remark** The graphs indicate nominal characteristics.

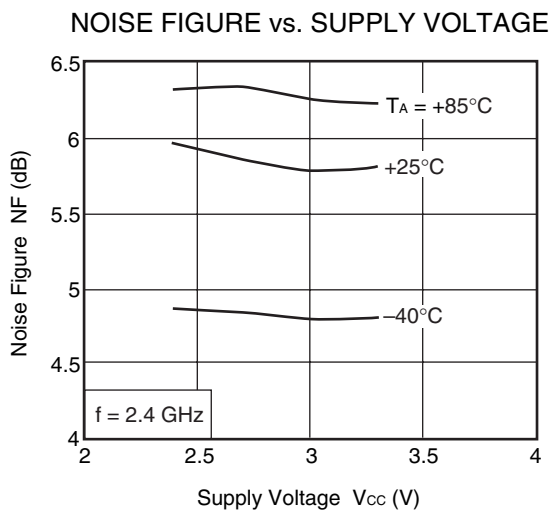
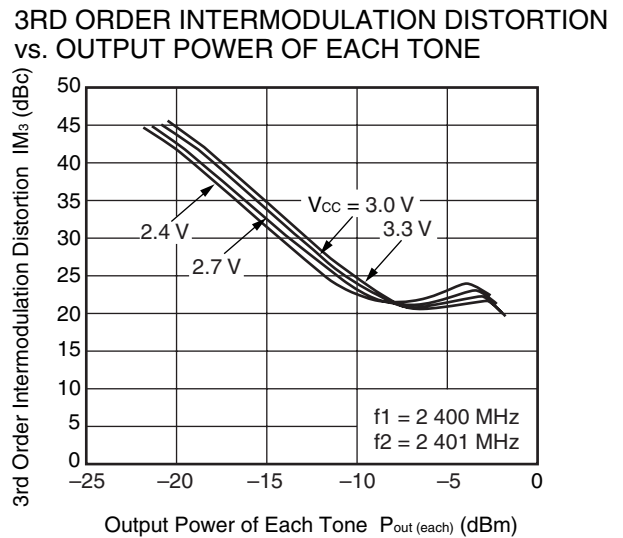
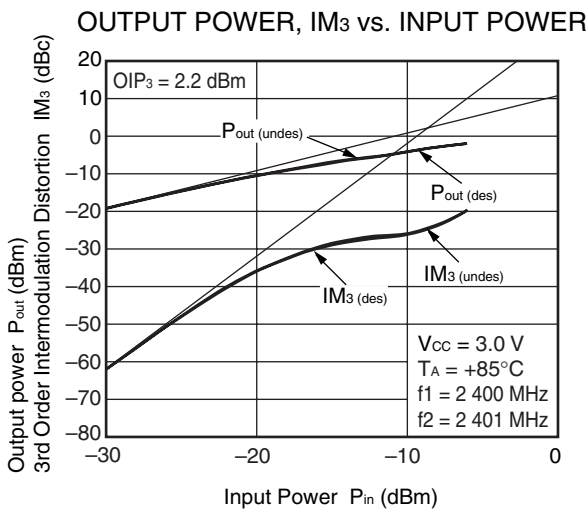
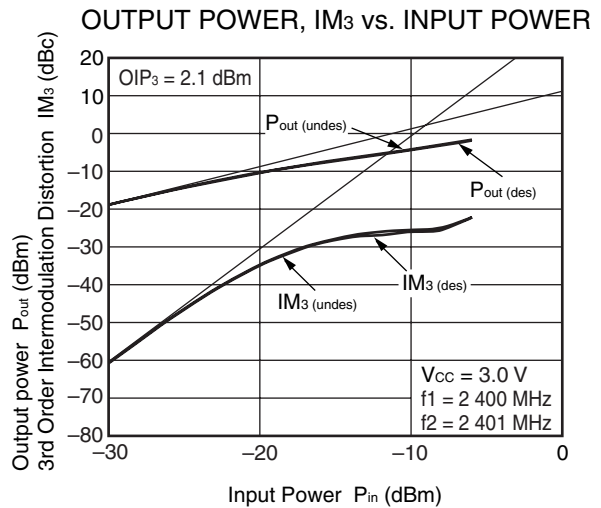
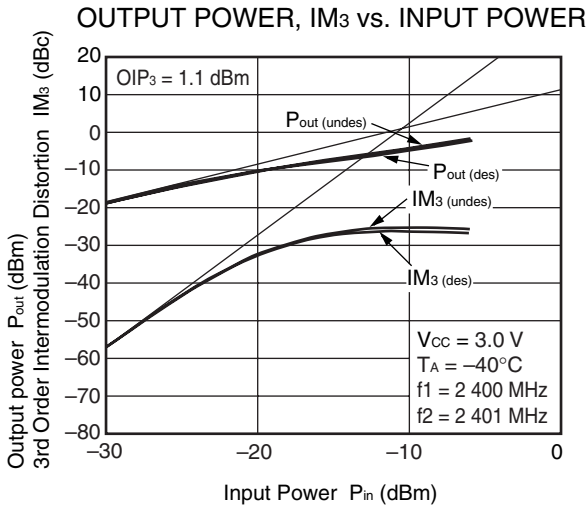

**Remark** The graphs indicate nominal characteristics.

**f = 3.0 GHz MATCHING**

S<sub>11</sub>-FREQUENCY

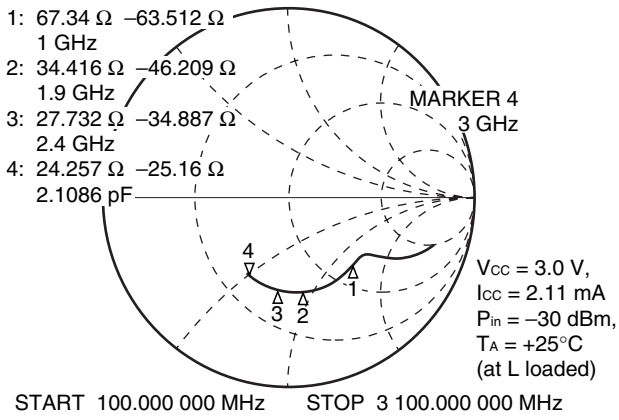

S<sub>22</sub>-FREQUENCY

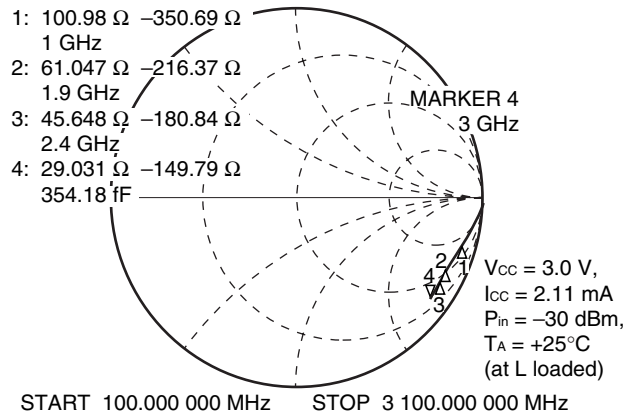

**Remark** The graphs indicate nominal characteristics.

★ PACKAGE DIMENSIONS

6-PIN LEAD-LESS MINIMOLD (1511) (UNIT: mm)

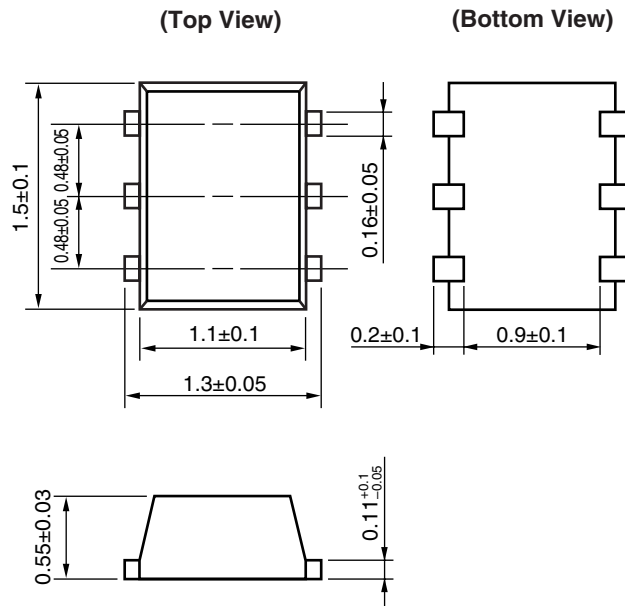



**NOTE ON CORRECT USE**

- (1) Observe precautions for handling because of electro-static sensitive devices.
- (2) Form a ground pattern as widely as possible to minimize ground impedance (to prevent undesired oscillation).  
All the ground pins must be connected together with wide ground pattern to decrease impedance difference.
- (3) The bypass capacitor should be attached to Vcc line.
- (4) The inductor (L) should be attached between output and Vcc pins. The L and series capacitor (C) values should be adjusted for applied frequency to match impedance to next stage.
- (5) The DC capacitor must be attached to input pin.

★ **RECOMMENDED SOLDERING CONDITIONS**

This product should be soldered and mounted under the following recommended conditions. For soldering methods and conditions other than those recommended below, contact your nearby sales office.

Soldering Method	Soldering Conditions	Condition Symbol
Infrared Reflow	Peak temperature (package surface temperature) : 260°C or below Time at peak temperature : 10 seconds or less Time at temperature of 220°C or higher : 60 seconds or less Preheating time at 120 to 180°C : 120±30 seconds Maximum number of reflow processes : 3 times Maximum chlorine content of rosin flux (% mass) : 0.2%(Wt.) or below	IR260
Wave Soldering	Peak temperature (molten solder temperature) : 260°C or below Time at peak temperature : 10 seconds or less Preheating temperature (package surface temperature) : 120°C or below Maximum number of flow processes : 1 time Maximum chlorine content of rosin flux (% mass) : 0.2%(Wt.) or below	WS260
Partial Heating	Peak temperature (terminal temperature) : 350°C or below Soldering time (per side of device) : 3 seconds or less Maximum chlorine content of rosin flux (% mass) : 0.2%(Wt.) or below	HS350

**Caution Do not use different soldering methods together (except for partial heating).**

When the product(s) listed in this document is subject to any applicable import or export control laws and regulation of the authority having competent jurisdiction, such product(s) shall not be imported or exported without obtaining the import or export license.

- **The information in this document is current as of March, 2005. The information is subject to change without notice. For actual design-in, refer to the latest publications of NEC's data sheets or data books, etc., for the most up-to-date specifications of NEC semiconductor products. Not all products and/or types are available in every country. Please check with an NEC sales representative for availability and additional information.**
  - No part of this document may be copied or reproduced in any form or by any means without prior written consent of NEC. NEC assumes no responsibility for any errors that may appear in this document.
  - NEC does not assume any liability for infringement of patents, copyrights or other intellectual property rights of third parties by or arising from the use of NEC semiconductor products listed in this document or any other liability arising from the use of such products. No license, express, implied or otherwise, is granted under any patents, copyrights or other intellectual property rights of NEC or others.
  - Descriptions of circuits, software and other related information in this document are provided for illustrative purposes in semiconductor product operation and application examples. The incorporation of these circuits, software and information in the design of customer's equipment shall be done under the full responsibility of customer. NEC assumes no responsibility for any losses incurred by customers or third parties arising from the use of these circuits, software and information.
  - While NEC endeavours to enhance the quality, reliability and safety of NEC semiconductor products, customers agree and acknowledge that the possibility of defects thereof cannot be eliminated entirely. To minimize risks of damage to property or injury (including death) to persons arising from defects in NEC semiconductor products, customers must incorporate sufficient safety measures in their design, such as redundancy, fire-containment, and anti-failure features.
  - NEC semiconductor products are classified into the following three quality grades:  
 "Standard", "Special" and "Specific". The "Specific" quality grade applies only to semiconductor products developed based on a customer-designated "quality assurance program" for a specific application. The recommended applications of a semiconductor product depend on its quality grade, as indicated below. Customers must check the quality grade of each semiconductor product before using it in a particular application.  
 "Standard": Computers, office equipment, communications equipment, test and measurement equipment, audio and visual equipment, home electronic appliances, machine tools, personal electronic equipment and industrial robots  
 "Special": Transportation equipment (automobiles, trains, ships, etc.), traffic control systems, anti-disaster systems, anti-crime systems, safety equipment and medical equipment (not specifically designed for life support)  
 "Specific": Aircraft, aerospace equipment, submersible repeaters, nuclear reactor control systems, life support systems and medical equipment for life support, etc.
- The quality grade of NEC semiconductor products is "Standard" unless otherwise expressly specified in NEC's data sheets or data books, etc. If customers wish to use NEC semiconductor products in applications not intended by NEC, they must contact an NEC sales representative in advance to determine NEC's willingness to support a given application.
- (Note)
- (1) "NEC" as used in this statement means NEC Corporation, NEC Compound Semiconductor Devices, Ltd. and also includes its majority-owned subsidiaries.
  - (2) "NEC semiconductor products" means any semiconductor product developed or manufactured by or for NEC (as defined above).

M8E 00.4-0110

---

► For further information, please contact

**NEC Compound Semiconductor Devices, Ltd.** <http://www.ncsd.necel.com/>

E-mail: [salesinfo@ml.ncsd.necel.com](mailto:salesinfo@ml.ncsd.necel.com) (sales and general)

[techinfo@ml.ncsd.necel.com](mailto:techinfo@ml.ncsd.necel.com) (technical)

Sales Division TEL: +81-44-435-1588 FAX: +81-44-435-1579

**NEC Compound Semiconductor Devices Hong Kong Limited**

E-mail: [ncsd-hk@elhk.nec.com.hk](mailto:ncsd-hk@elhk.nec.com.hk) (sales, technical and general)

Hong Kong Head Office TEL: +852-3107-7303 FAX: +852-3107-7309

Taipei Branch Office TEL: +886-2-8712-0478 FAX: +886-2-2545-3859

Korea Branch Office TEL: +82-2-558-2120 FAX: +82-2-558-5209

**NEC Electronics (Europe) GmbH** <http://www.ee.nec.de/>

TEL: +49-211-6503-0 FAX: +49-211-6503-1327

**California Eastern Laboratories, Inc.** <http://www.cel.com/>

TEL: +1-408-988-3500 FAX: +1-408-988-0279

Компания «Океан Электроники» предлагает заключение долгосрочных отношений при поставках импортных электронных компонентов на взаимовыгодных условиях!

Наши преимущества:

- Поставка оригинальных импортных электронных компонентов напрямую с производств Америки, Европы и Азии, а так же с крупнейших складов мира;
- Широкая линейка поставок активных и пассивных импортных электронных компонентов (более 30 млн. наименований);
- Поставка сложных, дефицитных, либо снятых с производства позиций;
- Оперативные сроки поставки под заказ (от 5 рабочих дней);
- Экспресс доставка в любую точку России;
- Помощь Конструкторского Отдела и консультации квалифицированных инженеров;
- Техническая поддержка проекта, помощь в подборе аналогов, поставка прототипов;
- Поставка электронных компонентов под контролем ВП;
- Система менеджмента качества сертифицирована по Международному стандарту ISO 9001;
- При необходимости вся продукция военного и аэрокосмического назначения проходит испытания и сертификацию в лаборатории (по согласованию с заказчиком);
- Поставка специализированных компонентов военного и аэрокосмического уровня качества (Xilinx, Altera, Analog Devices, Intersil, Interpoint, Microsemi, Actel, Aeroflex, Peregrine, VPT, Syfer, Eurofarad, Texas Instruments, MS Kennedy, Miteq, Cobham, E2V, MA-COM, Hittite, Mini-Circuits, General Dynamics и др.);

Компания «Океан Электроники» является официальным дистрибьютором и эксклюзивным представителем в России одного из крупнейших производителей разъемов военного и аэрокосмического назначения «JONHON», а так же официальным дистрибьютором и эксклюзивным представителем в России производителя высокотехнологичных и надежных решений для передачи СВЧ сигналов «FORSTAR».



## JONHON

«JONHON» (основан в 1970 г.)

Разъемы специального, военного и аэрокосмического назначения:

(Применяются в военной, авиационной, аэрокосмической, морской, железнодорожной, горно- и нефтедобывающей отраслях промышленности)

«FORSTAR» (основан в 1998 г.)

ВЧ соединители, коаксиальные кабели, кабельные сборки и микроволновые компоненты:

(Применяются в телекоммуникациях гражданского и специального назначения, в средствах связи, РЛС, а так же военной, авиационной и аэрокосмической отраслях промышленности).



Телефон: 8 (812) 309-75-97 (многоканальный)

Факс: 8 (812) 320-03-32

Электронная почта: [ocean@oceanchips.ru](mailto:ocean@oceanchips.ru)

Web: <http://oceanchips.ru/>

Адрес: 198099, г. Санкт-Петербург, ул. Калинина, д. 2, корп. 4, лит. А