

Thyristor/Diode and Thyristor/Thyristor, 135 A to 160 A (New INT-A-PAK Power Modules)



New INT-A-PAK

FEATURES

- High voltage
- Electrically isolated by DBC ceramic (Al_2O_3)
- 3500 V_{RMS} isolating voltage
- Industrial standard package
- High surge capability
- Glass passivated chips
- Modules uses high voltage power thyristor/diodes in three basic configurations
- Simple mounting
- UL approved file E78996 
- Compliant to RoHS directive 2002/95/EC
- Designed and qualified for multiple level



RoHS
COMPLIANT

PRODUCT SUMMARY

| | |
|-------------|----------------|
| $I_{T(AV)}$ | 135 A to 160 A |
|-------------|----------------|

APPLICATIONS

- DC motor control and drives
- Battery charges
- Welders
- Power converters
- Lighting control
- Heat and temperature control

MAJOR RATINGS AND CHARACTERISTICS

| SYMBOL | CHARACTERISTICS | VSK.136.. | VSK.142.. | VSK.162.. | UNITS |
|---------------|-----------------|-------------|-----------|-----------|----------------|
| $I_{T(AV)}$ | 85 °C | 135 | 140 | 160 | A |
| $I_{T(RMS)}$ | | 300 | 310 | 355 | A |
| I_{TSM} | 50 Hz | 3200 | 4500 | 4870 | |
| | 60 Hz | 3360 | 4712 | 5100 | |
| I^2t | 50 Hz | 51.5 | 102 | 119 | kA^2s |
| | 60 Hz | 47 | 92.5 | 108 | |
| $I^2\sqrt{t}$ | | 515.5 | 1013 | 1190 | $kA^2\sqrt{s}$ |
| V_{RRM} | Range | 400 to 1600 | | | V |
| T_J | Range | - 40 to 125 | | | °C |

ELECTRICAL SPECIFICATIONS

VOLTAGE RATINGS

| TYPE NUMBER | VOLTAGE CODE | V_{RRM}/V_{DRM} , MAXIMUM REPETITIVE PEAK REVERSE VOLTAGE V | V_{RSM}/V_{DSM} , MAXIMUM NON-REPETITIVE PEAK REVERSE VOLTAGE V | I_{RRM}/I_{DRM} AT 125 °C mA |
|-------------------------------|--------------|------------------------------------------------------------------|----------------------------------------------------------------------|-----------------------------------|
| VSK.136 VSK.142 VSK.162 | 04 | 400 | 500 | 50 |
| | 08 | 800 | 900 | |
| | 12 | 1200 | 1300 | |
| | 14 | 1400 | 1500 | |
| | 16 | 1600 | 1700 | |

VSK.136..PbF, VSK.142..PbF, VSK.162..PbF Series



Vishay High Power Products

Thyristor/Diode and
Thyristor/Thyristor, 135 A to 160 A
(New INT-A-PAK Power Modules)

| FORWARD CONDUCTION | | | | | | | | |
|----------------------------------------------------------------|---------------|-----------------------------------------------------------------------------------------------|---------------------------|---------|---------|---------|--------------------|-------------------|
| PARAMETER | SYMBOL | TEST CONDITIONS | | VSK.136 | VSK.142 | VSK.162 | UNITS | |
| Maximum average on-state current at case temperature | $I_{T(AV)}$ | 180° conduction, half sine wave | | 135 | 140 | 160 | A | |
| | | | | 85 | 85 | 85 | °C | |
| Maximum RMS on-state current | $I_{T(RMS)}$ | As AC switch | | 300 | 310 | 355 | A | |
| Maximum peak, one-cycle on-state, non-repetitive surge current | I_{TSM} | t = 10 ms | No voltage reapplied | 3200 | 4500 | 4870 | | |
| | | t = 8.3 ms | No voltage reapplied | 3360 | 4712 | 5100 | | |
| | | t = 10 ms | 100 % V_{RRM} reapplied | 2700 | 3785 | 4100 | | |
| | | t = 8.3 ms | 100 % V_{RRM} reapplied | 2800 | 3963 | 4300 | | |
| Maximum I^2t for fusing | I^2t | t = 10 ms | No voltage reapplied | 51.5 | 102 | 119 | | kA ² s |
| | | t = 8.3 ms | No voltage reapplied | 47 | 92.5 | 108 | | |
| | | t = 10 ms | 100 % V_{RRM} reapplied | 36.5 | 71.6 | 84 | | |
| | | t = 8.3 ms | 100 % V_{RRM} reapplied | 33.3 | 65.4 | 76.7 | | |
| Maximum $I^2\sqrt{t}$ for fusing | $I^2\sqrt{t}$ | t = 0.1 ms to 10 ms, no voltage reapplied | | 515.5 | 1013 | 1190 | kA ² √s | |
| Low level value of threshold voltage | $V_{T(TO)1}$ | (16.7 % $\times \pi \times I_{T(AV)} < I < \pi \times I_{T(AV)}$, T_J maximum) | | 0.86 | 0.83 | 0.8 | V | |
| High level value of threshold voltage | $V_{T(TO)2}$ | (I $> \pi \times I_{T(AV)}$, T_J maximum) | | 1.05 | 1 | 0.98 | | |
| Low level value on-state slope resistance | r_{t1} | (16.7 % $\times \pi \times I_{T(AV)} < I < \pi \times I_{T(AV)}$, T_J maximum) | | 2.02 | 1.78 | 1.67 | mΩ | |
| High level value on-state slope resistance | r_{t2} | (I $> \pi \times I_{T(AV)}$, T_J maximum) | | 1.65 | 1.43 | 1.38 | | |
| Maximum on-state voltage drop | V_{TM} | $I_{TM} = \pi \times I_{T(AV)}$, $T_J = 25^\circ\text{C}$, 180° conduction | | 1.57 | 1.55 | 1.54 | V | |
| Maximum forward voltage drop | V_{FM} | $I_{TM} = \pi \times I_{T(AV)}$, $T_J = 25^\circ\text{C}$, 180° conduction | | 1.57 | 1.55 | 1.54 | V | |
| Maximum holding current | I_H | Anode supply = 6 V initial $I_T = 30$ A, $T_J = 25^\circ\text{C}$ | | 200 | | | mA | |
| Maximum latching current | I_L | Anode supply = 6 V resistive load = 1 Ω Gate pulse: 10 V, 100 μs, $T_J = 25^\circ\text{C}$ | | 400 | | | | |

| SWITCHING | | | | | | |
|-----------------------|----------|----------------------------------------------------------------------------------------------------------------|-------------------------------------------------------------------|-----------|--|-------|
| PARAMETER | SYMBOL | TEST CONDITIONS | | VALUES | | UNITS |
| Typical delay time | t_{gd} | $T_J = 25^\circ\text{C}$ | Gate current = 1 A, $di_g/dt = 1$ A/μs $V_d = 0.67 \% V_{DRM}$ | 1 | | μs |
| Typical rise time | t_{gr} | | | 2 | | |
| Typical turn-off time | t_q | $I_{TM} = 300$ A, - $di/dt = 15$ A/μs; $T_J = T_J$ maximum $V_R = 50$ V; $dV/dt = 20$ V/μs; gate 0 V, 100 Ω | | 50 to 200 | | |

| BLOCKING | | | | | | |
|----------------------------------------------------|--------------------------|----------------------------------------------------------|--|--------|--|-------|
| PARAMETER | SYMBOL | TEST CONDITIONS | | VALUES | | UNITS |
| Maximum peak reverse and off-state leakage current | I_{RRM} , I_{DRM} | $T_J = 125^\circ\text{C}$ | | 50 | | mA |
| RMS insulation voltage | V_{INS} | 50 Hz, circuit to base, all terminals shorted, t = 1 s | | 3500 | | V |
| Critical rate of rise of off-state voltage | dV/dt | $T_J = T_J$ maximum, exponential to 67 % rated V_{DRM} | | 1000 | | V/μs |



VSK.136..PbF, VSK.142..PbF, VSK.162..PbF Series

Thyristor/Diode and Vishay High Power Products
 Thyristor/Thyristor, 135 A to 160 A
 (New INT-A-PAK Power Modules)

| TRIGGERING | | | | | |
|---------------------------------------------|-------------|---------------------------------------------------------------|-----------------------------------------------------------|--------|------------|
| PARAMETER | SYMBOL | TEST CONDITIONS | | VALUES | UNITS |
| Maximum peak gate power | P_{GM} | $t_p \leq 5$ ms, $T_J = T_J$ maximum | | 12 | W |
| Maximum average gate power | $P_{G(AV)}$ | f = 50 Hz, $T_J = T_J$ maximum | | 3 | |
| Maximum peak gate current | I_{GM} | $t_p \leq 5$ ms, $T_J = T_J$ maximum | | 3 | A |
| Maximum peak negative gate voltage | $-V_{GT}$ | | | 10 | |
| Maximum required DC gate voltage to trigger | V_{GT} | $T_J = -40$ °C | Anode supply = 6 V, resistive load; $R_a = 1$ Ω | 4 | V |
| | | $T_J = 25$ °C | | 2.5 | |
| | | $T_J = T_J$ maximum | | 1.7 | |
| Maximum required DC gate current to trigger | I_{GT} | $T_J = -40$ °C | | 270 | mA |
| | | $T_J = 25$ °C | | 150 | |
| | | $T_J = T_J$ maximum | | 80 | |
| Maximum gate voltage that will not trigger | V_{GD} | $T_J = T_J$ maximum, rated V_{DRM} applied | | 0.3 | V |
| Maximum gate current that will not trigger | I_{GD} | | | 10 | mA |
| Maximum rate of rise of turned-on current | di/dt | $T_J = T_J$ maximum, $I_{TM} = 400$ A rated V_{DRM} applied | | 300 | A/ μ s |

| THERMAL AND MECHANICAL SPECIFICATIONS | | | | | |
|-----------------------------------------------------------|----------------------------------|--------------------------------------------------------------------------------------------------------------------------------------------------------------|---------------|-------|----------|
| PARAMETER | SYMBOL | TEST CONDITIONS | VALUES | UNITS | |
| Maximum junction operating temperature range | T_J | | - 40 to 125 | °C | |
| Maximum storage temperature range | T_{Stg} | | - 40 to 150 | | |
| Maximum thermal resistance, junction to case per junction | R_{thJC} | DC operation | 0.18 | 0.16 | K/W |
| Maximum thermal resistance, case to heatsink per module | R_{thCS} | Mounting surface, smooth, flat and greased | 0.05 | | |
| Mounting torque ± 10 % | IAP to heatsink busbar to IAP | A mounting compound is recommended and the torque should be rechecked after a period of 3 hours to allow for the spread of the compound. Lubricated threads. | 4 to 6 | | Nm |
| Approximate weight | | | 200 | 7.1 | g oz. |
| Case style | | | New INT-A-PAK | | |

| ΔR CONDUCTION PER JUNCTION | | | | | | | | | | | |
|------------------------------------|----------------------------------------|--------|--------|--------|--------|-----------------------------------------|--------|--------|--------|--------|-------|
| DEVICES | SINUSOIDAL CONDUCTION AT T_J MAXIMUM | | | | | RECTANGULAR CONDUCTION AT T_J MAXIMUM | | | | | UNITS |
| | 180° | 120° | 90° | 60° | 30° | 180° | 120° | 90° | 60° | 30° | |
| VSK.136 | 0.007 | 0.01 | 0.013 | 0.0155 | 0.017 | 0.009 | 0.012 | 0.014 | 0.015 | 0.017 | K/W |
| VSK.142 | 0.0019 | 0.0019 | 0.0020 | 0.0020 | 0.0021 | 0.0018 | 0.0022 | 0.0023 | 0.0023 | 0.0020 | |
| VSK.162 | 0.0030 | 0.0031 | 0.0032 | 0.0033 | 0.0034 | 0.0029 | 0.0036 | 0.0039 | 0.0041 | 0.0040 | |

Note

- Table shows the increment of thermal resistance R_{thJC} when devices operate at different conduction angles than DC

VSK.136..PbF, VSK.142..PbF, VSK.162..PbF Series



Vishay High Power Products

Thyristor/Diode and
Thyristor/Thyristor, 135 A to 160 A
(New INT-A-PAK Power Modules)



Fig. 1 - Current Ratings Characteristics

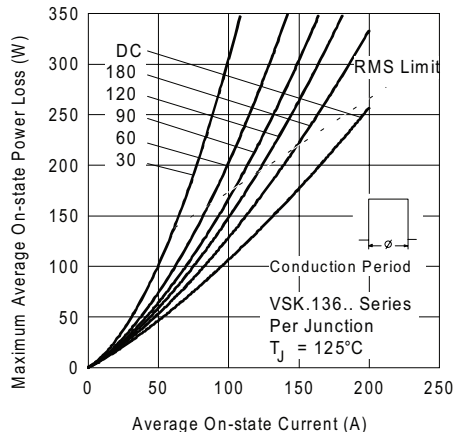

Fig. 4 - On-State Power Loss Characteristics



Fig. 2 - Current Ratings Characteristics

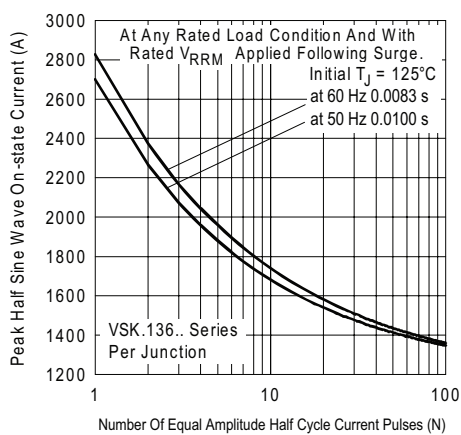

Fig. 5 - Maximum Non-Repetitive Surge Current



Fig. 3 - On-State Power Loss Characteristics

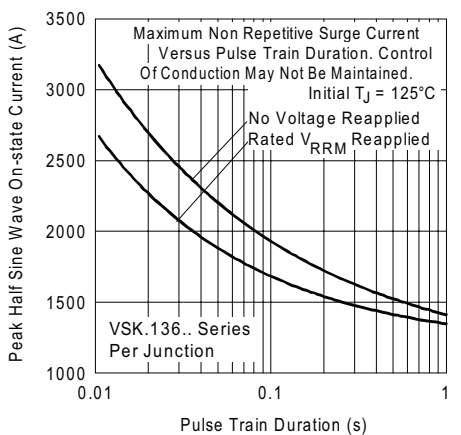

Fig. 6 - Maximum Non-Repetitive Surge Current



VSK.136..PbF, VSK.142..PbF, VSK.162..PbF Series

Thyristor/Diode and
Thyristor/Thyristor, 135 A to 160 A
(New INT-A-PAK Power Modules)

Vishay High Power Products

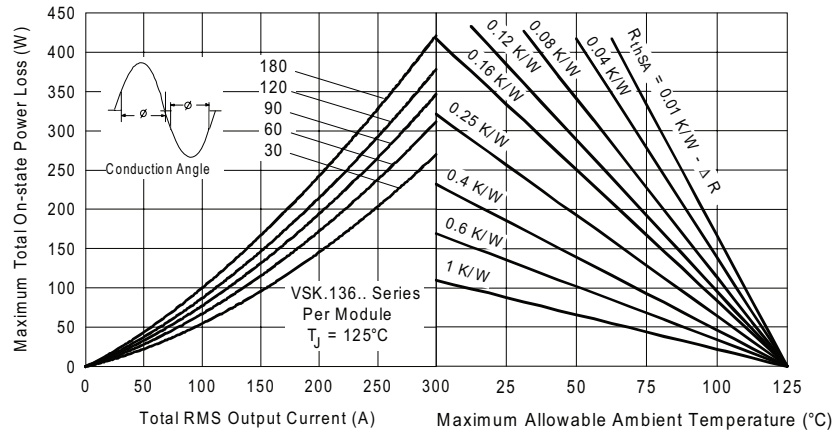

Fig. 7 - On-State Power Loss Characteristics

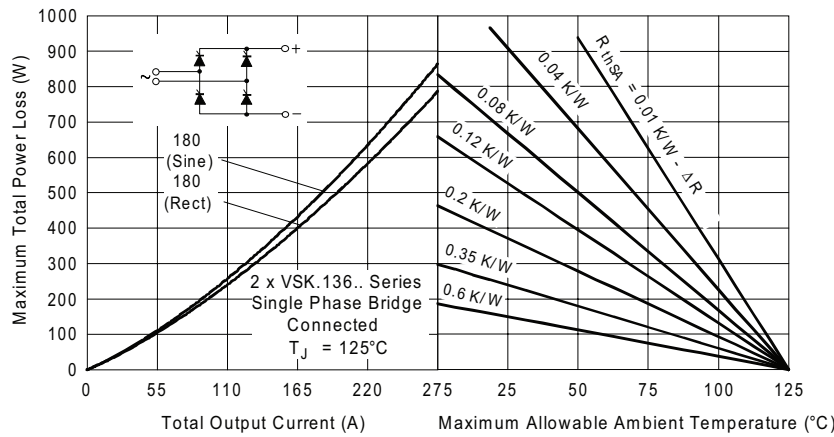

Fig. 8 - On-State Power Loss Characteristics



Fig. 9 - On-State Power Loss Characteristics

VSK.136..PbF, VSK.142..PbF, VSK.162..PbF Series



Vishay High Power Products

Thyristor/Diode and
Thyristor/Thyristor, 135 A to 160 A
(New INT-A-PAK Power Modules)



Fig. 10 - Current Ratings Characteristics



Fig. 13 - On-State Power Loss Characteristics



Fig. 11 - Current Ratings Characteristics



Fig. 14 - Maximum Non-Repetitive Surge Current



Fig. 12 - On-State Power Loss Characteristics

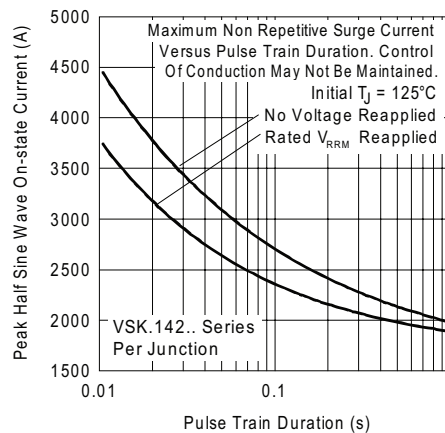

Fig. 15 - Maximum Non-Repetitive Surge Current



VSK.136..PbF, VSK.142..PbF, VSK.162..PbF Series

Thyristor/Diode and Thyristor/Thyristor, 135 A to 160 A
 Vishay High Power Products
 (New INT-A-PAK Power Modules)



Fig. 16 - On-State Power Loss Characteristics

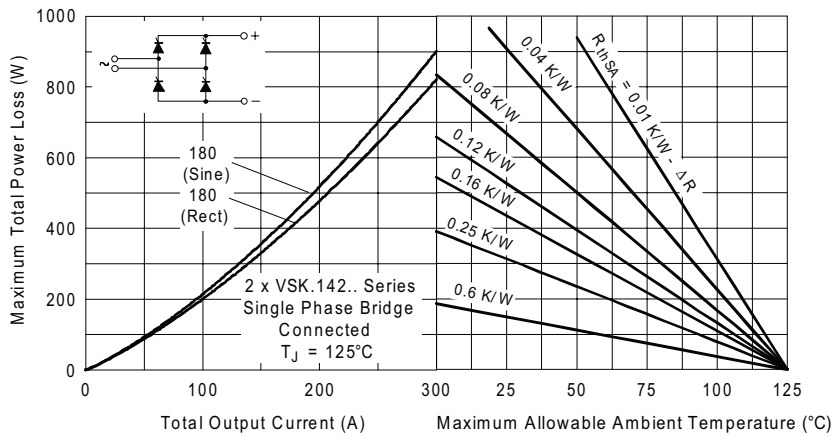

Fig. 17 - On-State Power Loss Characteristics

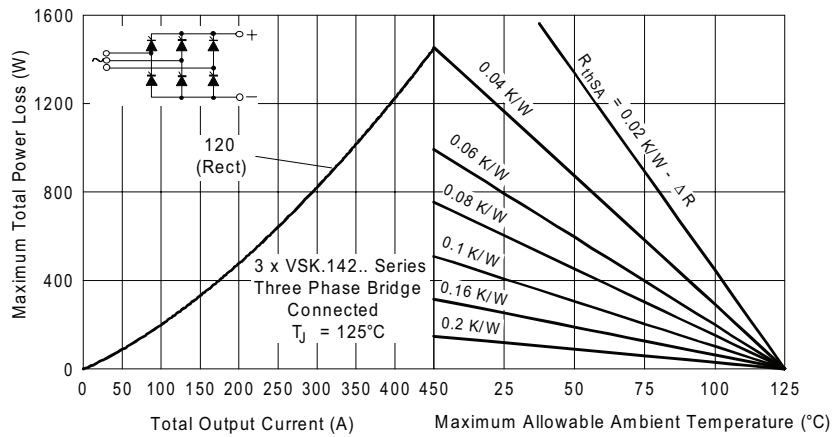

Fig. 18 - On-State Power Loss Characteristics

VSK.136..PbF, VSK.142..PbF, VSK.162..PbF Series



Vishay High Power Products

Thyristor/Diode and
Thyristor/Thyristor, 135 A to 160 A
(New INT-A-PAK Power Modules)



Fig. 19 - Current Ratings Characteristics



Fig. 22 - On-State Power Loss Characteristics

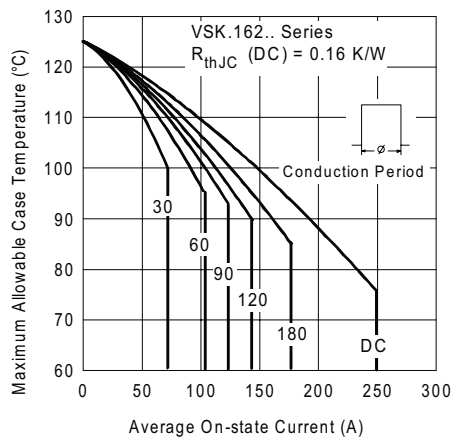

Fig. 20 - Current Ratings Characteristics



Fig. 23 - Maximum Non-Repetitive Surge Current



Fig. 21 - On-State Power Loss Characteristics



Fig. 24 - Maximum Non-Repetitive Surge Current



VSK.136..PbF, VSK.142..PbF, VSK.162..PbF Series

Thyristor/Diode and Thyristor/Thyristor, 135 A to 160 A
 Vishay High Power Products
 (New INT-A-PAK Power Modules)



Fig. 25 - On-State Power Loss Characteristics



Fig. 26 - On-State Power Loss Characteristics



Fig. 27 - On-State Power Loss Characteristics

VSK.136..PbF, VSK.142..PbF, VSK.162..PbF Series



Vishay High Power Products

Thyristor/Diode and
Thyristor/Thyristor, 135 A to 160 A
(New INT-A-PAK Power Modules)

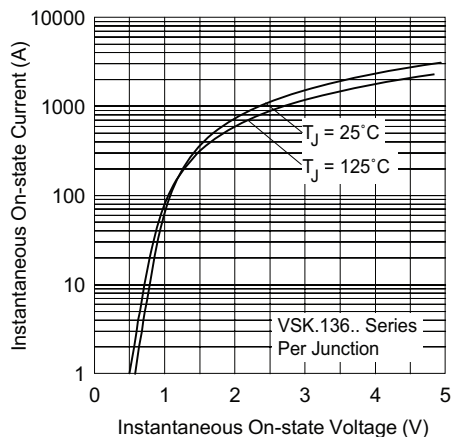

Fig. 28 - On-State Voltage Drop Characteristics

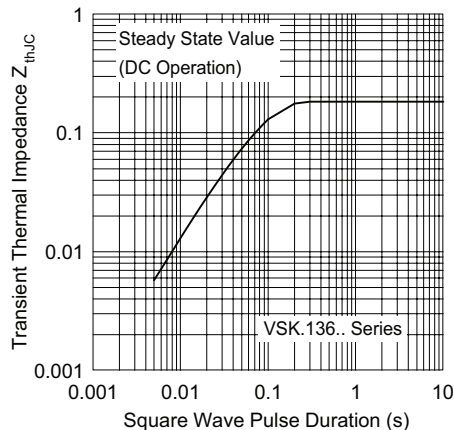

Fig. 31 - Thermal Impedance Z_{thJC} Characteristics

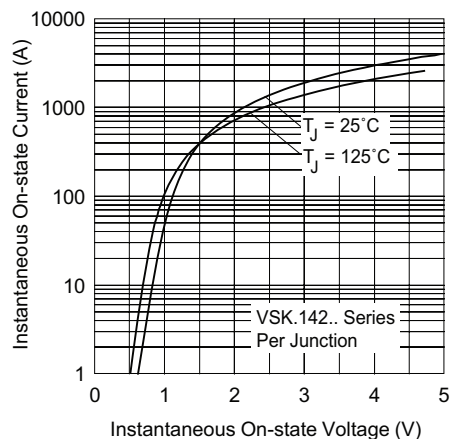

Fig. 29 - On-State Voltage Drop Characteristics

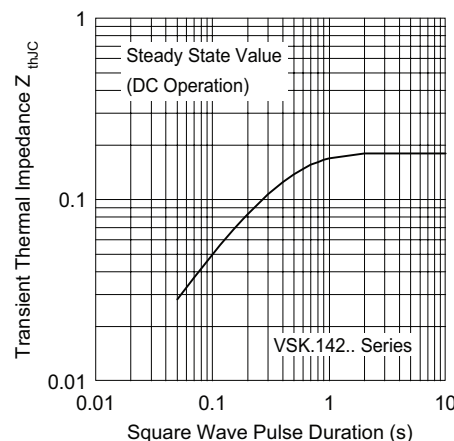

Fig. 32 - Thermal Impedance Z_{thJC} Characteristics

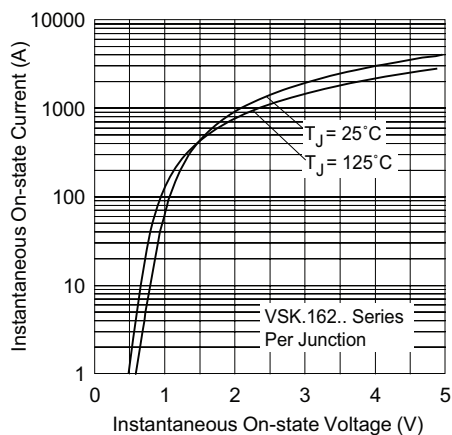

Fig. 30 - On-State Voltage Drop Characteristics

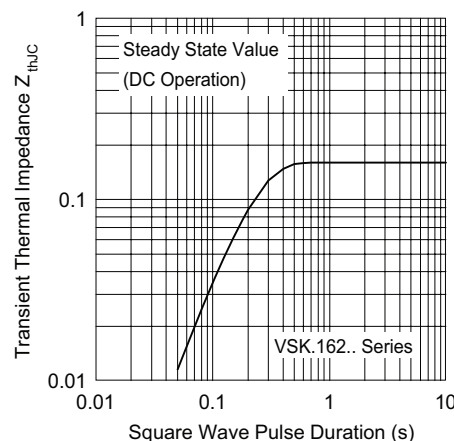

Fig. 33 - Thermal Impedance Z_{thJC} Characteristics



VSK.136..PbF, VSK.142..PbF, VSK.162..PbF Series

Thyristor/Diode and Vishay High Power Products
 Thyristor/Thyristor, 135 A to 160 A
 (New INT-A-PAK Power Modules)

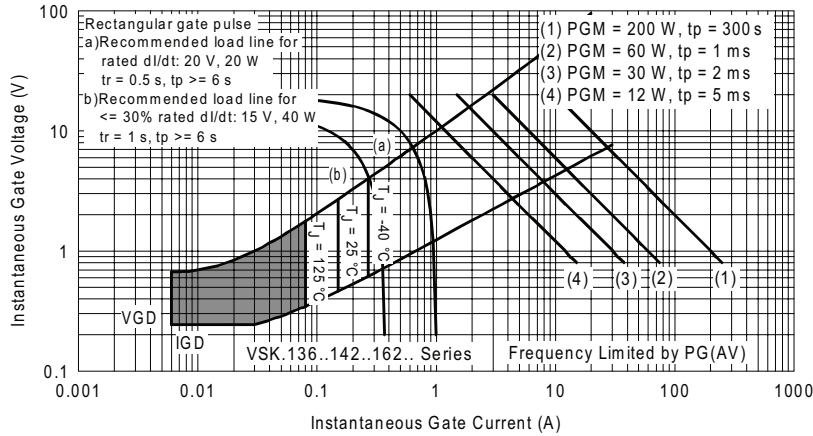

Fig. 34 - Gate Characteristics

ORDERING INFORMATION TABLE

| | | | | | | |
|-------------|------------|----------|--------------------------------|----------|-----------|------------|
| Device code | VSK | T | 162 | / | 16 | PbF |
| | ① | ② | ③ | | ④ | ⑤ |
| | 1 | - | Module type | | 2 | - |
| | 2 | - | Circuit configuration | | 3 | - |
| | 3 | - | Current rating: $I_{T(AV)}$ | | 4 | - |
| | 4 | - | Voltage code x 100 = V_{RRM} | | 5 | - |
| | 5 | - | PbF = Lead (Pb)-free | | | |

Note

- To order the optional hardware go to www.vishay.com/doc?95172

CIRCUIT CONFIGURATION

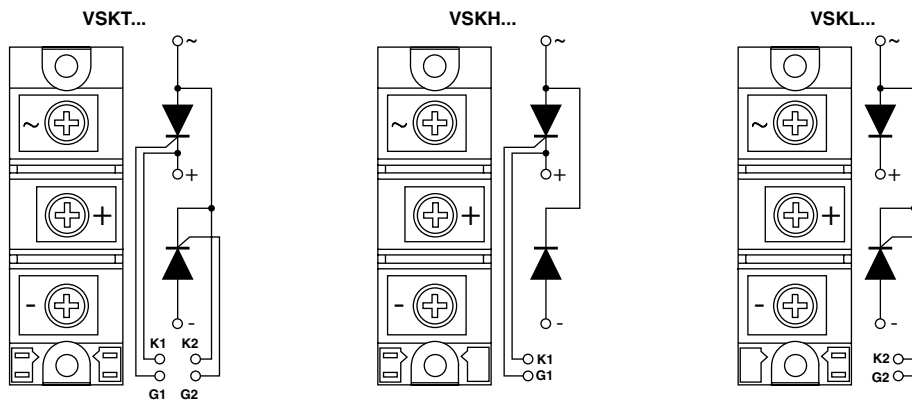

LINKS TO RELATED DOCUMENTS

Dimensions

www.vishay.com/doc?95067

INT-A-PAK IGBT/Thyristor

DIMENSIONS in millimeters (inches)

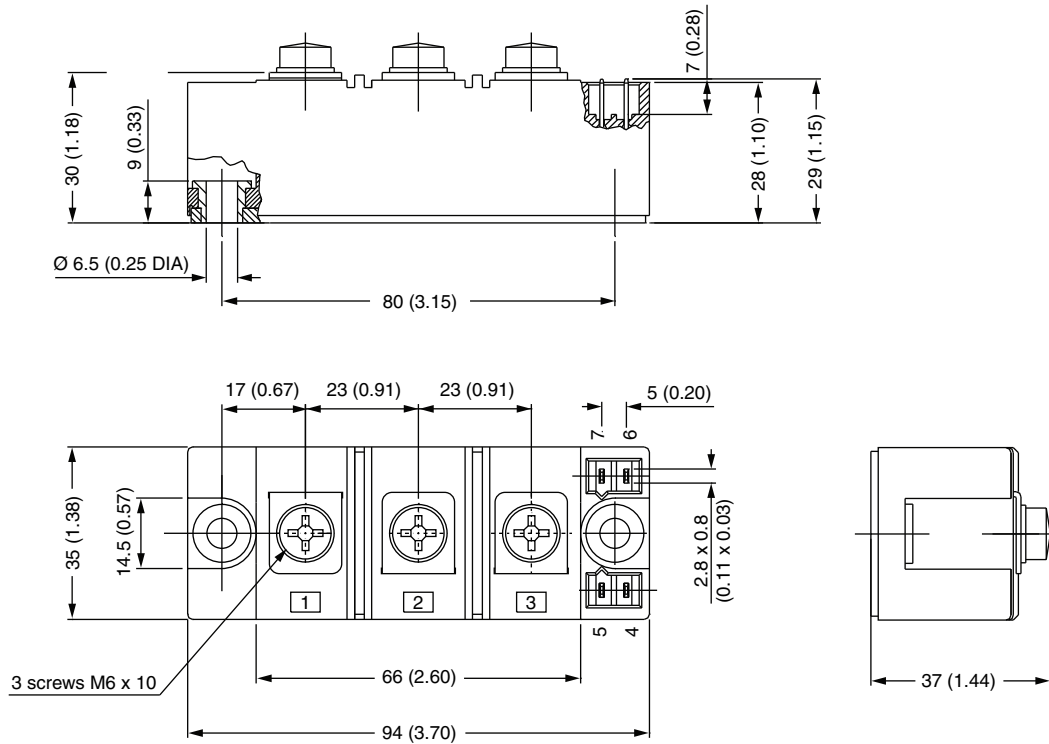



Disclaimer

ALL PRODUCT, PRODUCT SPECIFICATIONS AND DATA ARE SUBJECT TO CHANGE WITHOUT NOTICE TO IMPROVE RELIABILITY, FUNCTION OR DESIGN OR OTHERWISE.

Vishay Intertechnology, Inc., its affiliates, agents, and employees, and all persons acting on its or their behalf (collectively, "Vishay"), disclaim any and all liability for any errors, inaccuracies or incompleteness contained in any datasheet or in any other disclosure relating to any product.

Vishay makes no warranty, representation or guarantee regarding the suitability of the products for any particular purpose or the continuing production of any product. To the maximum extent permitted by applicable law, Vishay disclaims (i) any and all liability arising out of the application or use of any product, (ii) any and all liability, including without limitation special, consequential or incidental damages, and (iii) any and all implied warranties, including warranties of fitness for particular purpose, non-infringement and merchantability.

Statements regarding the suitability of products for certain types of applications are based on Vishay's knowledge of typical requirements that are often placed on Vishay products in generic applications. Such statements are not binding statements about the suitability of products for a particular application. It is the customer's responsibility to validate that a particular product with the properties described in the product specification is suitable for use in a particular application. Parameters provided in datasheets and/or specifications may vary in different applications and performance may vary over time. All operating parameters, including typical parameters, must be validated for each customer application by the customer's technical experts. Product specifications do not expand or otherwise modify Vishay's terms and conditions of purchase, including but not limited to the warranty expressed therein.

Except as expressly indicated in writing, Vishay products are not designed for use in medical, life-saving, or life-sustaining applications or for any other application in which the failure of the Vishay product could result in personal injury or death. Customers using or selling Vishay products not expressly indicated for use in such applications do so at their own risk. Please contact authorized Vishay personnel to obtain written terms and conditions regarding products designed for such applications.

No license, express or implied, by estoppel or otherwise, to any intellectual property rights is granted by this document or by any conduct of Vishay. Product names and markings noted herein may be trademarks of their respective owners.

Material Category Policy

Vishay Intertechnology, Inc. hereby certifies that all its products that are identified as RoHS-Compliant fulfill the definitions and restrictions defined under Directive 2011/65/EU of The European Parliament and of the Council of June 8, 2011 on the restriction of the use of certain hazardous substances in electrical and electronic equipment (EEE) - recast, unless otherwise specified as non-compliant.

Please note that some Vishay documentation may still make reference to RoHS Directive 2002/95/EC. We confirm that all the products identified as being compliant to Directive 2002/95/EC conform to Directive 2011/65/EU.

Vishay Intertechnology, Inc. hereby certifies that all its products that are identified as Halogen-Free follow Halogen-Free requirements as per JEDEC JS709A standards. Please note that some Vishay documentation may still make reference to the IEC 61249-2-21 definition. We confirm that all the products identified as being compliant to IEC 61249-2-21 conform to JEDEC JS709A standards.

Компания «Океан Электроники» предлагает заключение долгосрочных отношений при поставках импортных электронных компонентов на взаимовыгодных условиях!

Наши преимущества:

- Поставка оригинальных импортных электронных компонентов напрямую с производств Америки, Европы и Азии, а так же с крупнейших складов мира;
- Широкая линейка поставок активных и пассивных импортных электронных компонентов (более 30 млн. наименований);
- Поставка сложных, дефицитных, либо снятых с производства позиций;
- Оперативные сроки поставки под заказ (от 5 рабочих дней);
- Экспресс доставка в любую точку России;
- Помощь Конструкторского Отдела и консультации квалифицированных инженеров;
- Техническая поддержка проекта, помощь в подборе аналогов, поставка прототипов;
- Поставка электронных компонентов под контролем ВП;
- Система менеджмента качества сертифицирована по Международному стандарту ISO 9001;
- При необходимости вся продукция военного и аэрокосмического назначения проходит испытания и сертификацию в лаборатории (по согласованию с заказчиком);
- Поставка специализированных компонентов военного и аэрокосмического уровня качества (Xilinx, Altera, Analog Devices, Intersil, Interpoint, Microsemi, Actel, Aeroflex, Peregrine, VPT, Syfer, Eurofarad, Texas Instruments, MS Kennedy, Miteq, Cobham, E2V, MA-COM, Hittite, Mini-Circuits, General Dynamics и др.);

Компания «Океан Электроники» является официальным дистрибьютором и эксклюзивным представителем в России одного из крупнейших производителей разъемов военного и аэрокосмического назначения «**JONHON**», а так же официальным дистрибьютором и эксклюзивным представителем в России производителя высокотехнологичных и надежных решений для передачи СВЧ сигналов «**FORSTAR**».



JONHON

«**JONHON**» (основан в 1970 г.)

Разъемы специального, военного и аэрокосмического назначения:

(Применяются в военной, авиационной, аэрокосмической, морской, железнодорожной, горно- и нефтедобывающей отраслях промышленности)

«**FORSTAR**» (основан в 1998 г.)

ВЧ соединители, коаксиальные кабели, кабельные сборки и микроволновые компоненты:

(Применяются в телекоммуникациях гражданского и специального назначения, в средствах связи, РЛС, а так же военной, авиационной и аэрокосмической отраслях промышленности).



Телефон: 8 (812) 309-75-97 (многоканальный)

Факс: 8 (812) 320-03-32

Электронная почта: ocean@oceanchips.ru

Web: <http://oceanchips.ru/>

Адрес: 198099, г. Санкт-Петербург, ул. Калинина, д. 2, корп. 4, лит. А