

Digital Timer H5CZ

Easy to Use and Easy to Read.



Basic Features

- Character height of 10 mm for better readability.
- Operation is simplified by the Up/Down Keys for each digit on 4-digit.

Safety and Reliability

- Power supply circuit and input circuits are isolated for safety and reliability.
- Set value limit function prevents unexpected operation of output devices caused by setting mistakes.
- Output counter function helps in managing the service life of the Timer or the load.

Other Features

- Models with instantaneous contact output.
- Waterproof, dust-proof structure (UL508 Type 4X and IP66).
- Key protection.



NEW

Refer to *Safety Precautions* on page 29.

Features

Basic Features

Better Readability

Character Height of 10 mm with a Wide Viewing Angle.

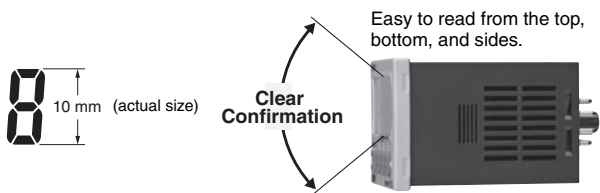

The Easiest Operation

Operation is simplified by the Up/Down Keys for each digit on 4-digit.

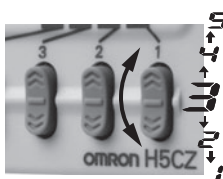

Set Value Limit

You can set an upper limit for the set value to prevent unexpected operation of output devices caused by setting mistakes.

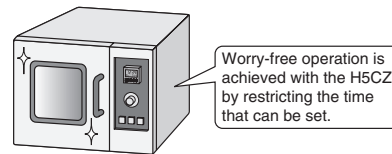

Output Counter

The output counter counts the number of times the output turns ON (alarm display, count monitoring, count in increments of 1,000). This counter is useful in managing the service life of the Timer or the load.

Other Features

Models with Instantaneous Contact Output

Models with instantaneous contact outputs have been added for use with self-holding circuits and as auxiliary relays. These models are also convenient when replacing analog timers.

Waterproof, Dust-proof Structure (UL508 Type 4X and IP66)

Worry-free application is possible in locations subject to water.
Note: When the Y92S-29 Waterproof Packing is used.

Key Protection

Select from any of seven protection patterns. Use the best one for the application.

New Modes

Modes, such as a stopwatch mode (Mode S), have been added. Select any of 15 modes.

Safety and Reliability

Isolated Power Supply and Input Circuits *1

Power supply circuit and input circuits are isolated for safety and reliability.

Previous non-isolated timers had wiring restrictions and could be damaged if wired incorrectly. The H5CZ removes these worries.

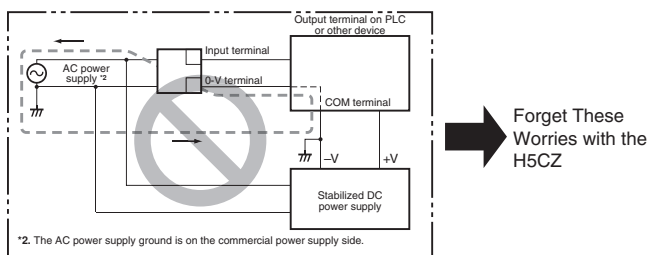

*1. H5CZ with 100 to 240-VAC specifications.

H5CZ

Model Number Structure

Model Number Legend

H5CZ-L

--	--	--

1 2 3

1. External Connections

Symbol	Meaning
8	8-pin socket

2. Output type

Symbol	Meaning
None	Contact output (time-limit SPDT)
E	Contact output (time-limit SPDT + instantaneous SPDT) *

* Can be used as a time-limit DPDT output.

3. Supply voltage

Symbol	Meaning
None	100 to 240 VAC 50/60 Hz
D	12 to 24 VDC/24 VAC 50/60 Hz

Ordering Information

List of Models

Type	Time specifications	Operating modes	External connections	Inputs	Outputs	Supply voltage	Models
H5CZ	0.001 to 9.999 s 0.01 to 99.99 s 0.1 to 999.9 s 1 to 9999 s 1 s to 99 min 59 s 0.1 to 999.9 min 1 to 9999 min 1 min to 99 h 59 min 0.1 to 999.9 h 1 to 9999 h	Timer Mode A: Signal ON Delay I A-1: Signal ON Delay II A-2: Power ON Delay I A-3: Power ON Delay II b: Repeat cycle 1 b-1: Repeat cycle 2 d: Signal OFF Delay E: Interval F: Cumulative Z: ON/OFF-duty-adjustable flicker S: Stopwatch	8-pin socket	Signal, Reset (NPN inputs)	Contact output (time-limit SPDT)	100 to 240 VAC	H5CZ-L8
		Twin Timer Mode toff: Flicker OFF Start 1 ton: Flicker ON Start 1 toff-1: Flicker OFF Start 2 ton-1: Flicker ON Start 2				12 to 24 VDC/24 VAC	H5CZ-L8D
		Timer Mode A-2: Power ON Delay I b: Repeat cycle 1 E: Interval Z: ON/OFF-duty-adjustable flicker		None	Contact output (time-limit SPDT + instantaneous SPDT) Models with instantaneous contact outputs	100 to 240 VAC	H5CZ-L8E
		Twin Timer Mode toff: Flicker OFF Start 1 ton: Flicker ON Start 1				12 to 24 VDC/24 VAC	H5CZ-L8ED

Note: The functions that are provided depend on the model. Check detailed specifications before ordering.

Accessories (Order Separately)

Soft Cover

Models	Page
Y92A-48F1	9

Hard Cover

Models	Page
Y92A-48	9

Flush Mounting Adapter

Models	Page
Y92F-30	9

Waterproof Packing

Models	Page
Y92S-29	9

Connection Sockets

Models	Type	Remarks	Page
P2CF-08	Front Connecting Socket	---	10
P2CF-08-E	Front Connecting Socket (Finger-safe Type)	Round crimp terminals cannot be used on Finger-safe Sockets. Use forked crimp terminals.	
P3G-08	Back Connecting Socket	A Y92A-48G Terminal Cover can be used with the Socket to create a finger-safe construction.	

Terminal Covers for P3G-08 Back-connecting Sockets

Models	Page
Y92A-48G	10

H5CZ Digital Timers

Specifications

Ratings

Item	Models	H5CZ-L8□	
Ratings	Power supply voltage *1	<ul style="list-style-type: none"> • 100 to 240 VAC 50/60 Hz • 12 to 24 VDC/24 VAC 50/60 Hz 	
	Operating voltage fluctuation range	85% to 110% of rated supply voltage (90% to 110% at 12 to 24 VDC)	
	Power consumption	Approx. 6.2 VA at 100 to 240 VAC, Approx. 5.1 VA/2.4 W at 24 VAC/12 to 24 VDC *2	
Mounting method	Flush mounting, Surface mounting, DIN track mounting		
External connections	8-pin socket		
Degree of protection	IEC IP66, UL508 Type 4X (indoors) for panel surface only and when Y92S-29 Waterproof Packing is used		
Digits	4 digits		
Time ranges	0.001 s to 9.999 s, 0.01 s to 99.99 s, 0.1 s to 999.9 s, 1 s to 9999 s, 1 s to 99 min 59 s 0.1 m to 999.9 min, 1 min to 9999 min, 1 min to 99 h 59 min, 0.1 h to 999.9 h, 1 h to 9999 h		
Timer mode	Elapsed time (Up), Remaining time (Down) (selectable)		
Inputs	Input signals	Signal, Reset (no inputs on models with instantaneous contact outputs)	
	Input method	No-voltage Input ON impedance: 1 kΩ max. (Leakage current: 12 mA when 0 Ω) ON residual voltage: 3 V max. OFF impedance: 100 kΩ min.	
	Signal, reset	Minimum input signal width: 1 or 20 ms (selectable, same for all input)	
Reset system	Power reset (depending on output mode), External reset, Manual reset, Automatic reset (depending on output mode)		
Power reset	Minimum power-opening time: 0.5 s (except for A-3, b-1, F, ton-1, and toff-1 mode)		
Reset voltage	10% max. of rated supply voltage		
Sensor waiting time	250 ms max. (Control output is turned OFF and no input is accepted during sensor waiting time.)		
Output	Output modes	A: Signal ON Delay I, A-1: Signal ON Delay II, A-2: Power ON Delay I, A-3: Power ON Delay II, b: Repeat Cycle 1, b-1: Repeat Cycle 2, d: Signal OFF Delay, E: Interval, F: Cumulative, Z: ON/OFF-duty-adjustable flicker, S: Stopwatch, toff: Flicker OFF Start 1, ton: Flicker ON Start 1, toff-1: Flicker OFF Start 2, ton-1: Flicker ON Start 2	Models with Instantaneous Contact Outputs A-2: Power ON Delay I, b: Repeat Cycle 1, E: Interval, Z: ON/OFF-duty-adjustable flicker, toff: Flicker OFF Start 1, ton: Flicker ON Start 1
	One-shot output time	0.01 to 99.99 s	
	Control output	5 A at 250 VAC/30 VDC, resistive load (cos =1) Minimum applied load: 10 mA at 5 VDC (failure level: P, reference value)	
Display method *3	LCD; Present value: 10-mm-high characters Set value: 6-mm-high characters		
Memory backup	EEPROM (overwrites: 100,000 times min.) that can store data for 10 years min.		
Operating temperature range	-10 to 55°C (-10 to 50°C if counters are mounted side by side) (with no icing or condensation)		
Storage temperature range	-25 to 70°C (with no icing or condensation)		
Operating humidity range	25% to 85%		
Front panel color	Light gray (5Y7/1)		

*1. Do not use the output from an inverter as the power supply. The ripple must be 20% maximum for DC power.

*2. Inrush current will flow for a short time when the power supply is turned ON.
Inrush Current (Reference Values)

Voltage	Applied voltage	Inrush current (peak value)	Time
100 to 240 VAC	264 VAC	5.3 A	0.4 ms
	26.4 VAC	6.4 A	1.4 ms
12 to 24 VDC/24 VAC	26.4 VDC	4.4 A	1.7 ms

*3. The display is lit only when the power is ON. Settings and changes are not possible if the power supply is not ON.

Characteristics

Accuracy of operating time and setting error (including temperature and voltage influences)	Power-ON start: $\pm 0.01\% \pm 50$ ms max. (See note) Signal start: $\pm 0.005\% \pm 0.03$ ms max. (See note) If the set value is within the sensor waiting time at startup the control output of the H5CZ will not turn ON until the sensor waiting time passes. Note: The values are based on the set value.	
Insulation resistance	100 M Ω min. (at 500 VDC) between current-carrying terminal and exposed non-current-carrying metal parts, and between non-continuous contacts	
Dielectric strength	2,000 VAC, 50/60 Hz for 1 min between current-carrying metal parts and non-current-carrying metal parts 2,000 VAC, 50/60 Hz for 1 min between power supply and input circuits for all models except H5CZ-□D 2,000 VAC, 50/60 Hz for 1 min between control output, power supply, and input circuits 1,000 VAC, 50/60 Hz for 1 min between non-continuous contacts	
Impulse withstand voltage	3 kV (between power terminals) for 100 to 240 VAC, 1 kV for 24 VAC/12 to 24 VDC 4.5 kV (between current-carrying terminal and exposed non-current-carrying metal parts) for 100 to 240 VAC 1.5 kV for 24 VAC/12 to 24 VDC	
Noise immunity	± 1.5 kV (between power terminals) and ± 600 V (between input terminals), square-wave noise by noise simulator (pulse width: 100 ns/1 μ s, 1-ns rise)	
Static immunity	Malfunction: 8 kV Destruction: 15 kV	
Vibration resistance	Destruction	10 to 55 Hz with 0.75-mm single amplitude each in three directions for 2 h each
	Malfunction	10 to 55 Hz with 0.35-mm single amplitude each in three directions for 10 min each
Shock resistance	Destruction	300 m/s ² in three directions, three cycles
	Malfunction	100 m/s ² in three directions, three cycles
Life expectancy	Mechanical	10,000,000 operations min. (under no load at 1,800 operations/h and ambient temperature of 23°C)
	Electrical	100,000 operations min. (5 A at 250 VAC, resistive load at 1,800 operations/h and ambient temperature of 23°C) *
Weight	Approx. 105 g (Timer only)	

* Refer to Life-test Curve.

Life-test Curve (Reference Values)

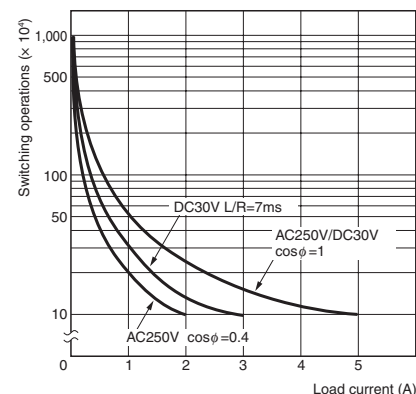

A maximum current of 0.15 A can be switched at 125 VDC ($\cos\phi = 1$) and a maximum current of 0.1 A can be switched if L/R is 7 ms. In both cases, a life of 100,000 operations can be expected.

Applicable Standards

Approved safety standards	UL508/Listing, UL50 Type 4X for indoor use (enclosure rating), CSA C22.2 No. 14 *, conforms to EN61812-1 (Pollution degree 2/overvoltage category III) B300 PILOT DUTY 1/4 HP 120 VAC, 1/3 HP, 240 VAC, 5 A resistive load VDE0106/P100 CCC: Pollution degree 2, Overvoltage category II	
EMC	(EMI)	EN61812-1
	Emission Enclosure:	EN55011 Group 1 class A
	Emission AC mains:	EN55011 Group 1 class A
	(EMS)	EN61812-1
	Immunity ESD:	EN61000-4-2: 6 kV contact discharge (level 2) 8 kV air discharge (level 3)
	Immunity RF-interference:	EN61000-4-3: 10 V/m (Amplitude-modulated, 80 MHz to 1 GHz) (level 3); 10 V/m (Pulse-modulated, 900 MHz 5 MHz) (level 3)
	Immunity Conducted Disturbance:	EN61000-4-6: 10 V (0.15 to 80 MHz) (level 3)
	Immunity Burst:	EN61000-4-4: 2 kV power-line (level 3); 1 kV I/O signal-line (level 4)
Immunity Surge:	EN61000-4-5: 1 kV line to lines (power and output lines) (level 3); 2 kV line to ground (power and output lines) (level 3)	
Immunity Voltage Dip/Interruption:	EN61000-4-11: 0.5 cycle, 100% (rated voltage)	

* The following safety standards apply to H5CZ.

cUL (Listing): Applicable when an OMRON P2CF (-E) Socket is used.

cUR (Recognition): Applicable when any other socket is used.

I/O Functions

For details, refer to the timing charts on **page 16 and page 25**.

Inputs *	Start signal	Normally functions to start timing. In modes A-2 and A-3, disable timing. In mode S, starts and stops timing.
	Reset	<ul style="list-style-type: none"> Resets present value. (In elapsed time mode, the present value returns to 0; in remaining time mode, the present value returns to the set value.) Count inputs are not accepted and control output turns OFF while reset input is ON. Reset indicator is lit while reset input is ON.
Outputs	Control output (OUT)	Outputs take place according to designated operating mode when timer reaches corresponding set value.

* The H5CZ-L8E□ does not have an input.

H5CZ

Connections

Block Diagram

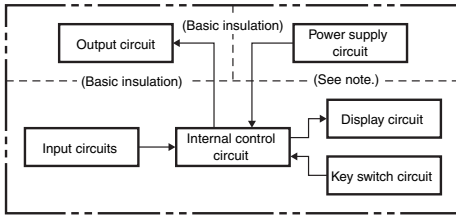

Note: Basic insulation is provided between the power supply circuit and the input circuits. However, basic insulation is not provided in the H5CZ-□D.

Terminal Arrangement

Confirm that the power supply meets specifications before use.

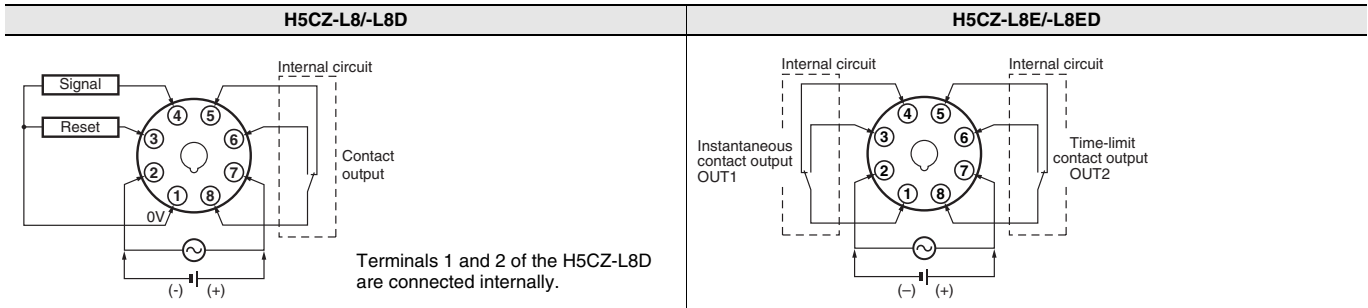

Note: Do not connect unused terminals as relay terminals.

Input Circuits

Signal and Reset Input

No-voltage Inputs (NPN Inputs)

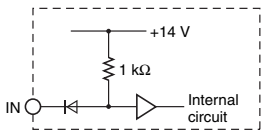

Input Connections

The inputs are no-voltage (closed or open). (The H5CZ-L8E□ does not have an input.)

No-voltage Inputs (NPN Inputs)

Open Collector

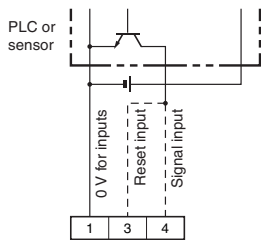

Note: Operate with transistor ON

Voltage Output

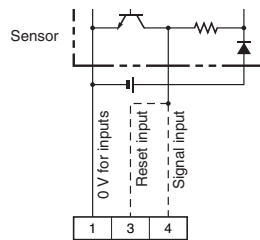

Note: Operate with transistor ON

Contact Input

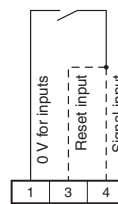

Note: Operate with contacts ON.

DC Two-wire Sensor

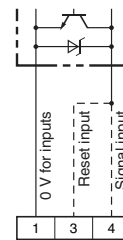

Note: Operate with transistor ON

No-voltage Input Signal Levels

No-contact input	Short-circuit level Transistor ON <ul style="list-style-type: none"> • Residual voltage: 3 V max. • Impedance when ON: 1 kΩ max. (The leakage current is approx. 12 mA when the impedance is 0 Ω.)
	Open level Transistor OFF <ul style="list-style-type: none"> • Impedance when OFF: 100 kΩ min.
Contact input	Use contacts which can adequately switch 5 mA at 10 V

Note: The DC voltage must be 30 VDC max.

Applicable Two-wire Sensor

- Leakage current: 1.5 mA max.
- Switching capacity: 5 mA min.
- Residual voltage: 3.0 VDC max.
- Operating voltage: 10 VDC

Nomenclature

Display Section

- 1. Key Protect Indicator**
- 2. Control Output Indicator**
- 3. Reset Indicator**
- 4. Present Value Display (Main display)**
(Character height: 10 mm)
- 5. Time Unit Indicators**
(If the time range is 0 min, 0 h, 0.0 h, or 0 h 0 min, these indicators flash to indicate timing operation.)
- 6. Set Value Display (Sub-display)**
(Character height: 6 mm)
- 7. Set Value 1, 2 Indicator**

Character Size
for Present
Value Display

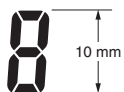

Character Size
for Set Value
Display

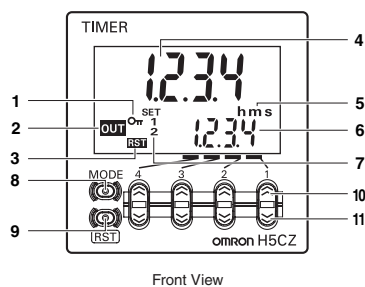
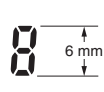

Front View

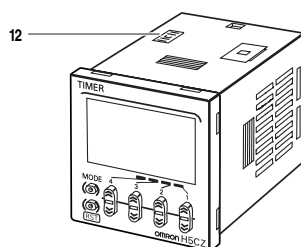

Operation Key

- 8. Mode Key**
(Changes modes and setting items)
- 9. Reset Key**
(Resets present value and output)
- 10. Up Keys 1 to 4**
- 11. Down Keys 1 to 4**

Switches

- 12. Key-protect Switch**

(Default setting) OFF (Disabled) ↔ ON (Enabled)

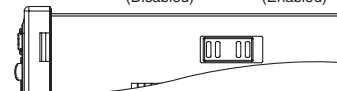

H5CZ

Dimensions

(unit: mm)

Digital Timers

Digital Timers

H5CZ-L8□ (Flush Mounting/Surface Mounting Models)

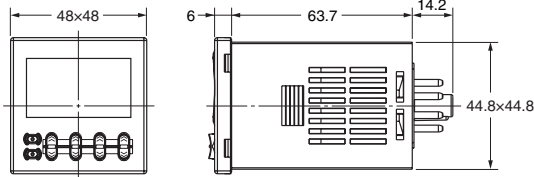

Panel Cutouts

Panel cutouts areas shown below. (according to DIN43700).

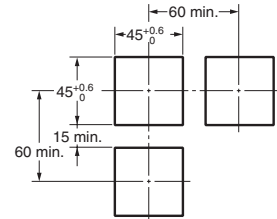

- Note:**
1. The mounting panel thickness should be 1 to 5 mm.
 2. To allow easier operation, it is recommended that Adapters be mounted so that the gap between sides with hooks is at least 15 mm (i.e., with the panel cutouts separated by at least 60 mm).
 3. It is possible to horizontally mount Timers side by side. Attach the Flush Mounting Adapters so that the surfaces without hooks are on the sides of the Timers. (However, if Timers are mounted side by side, water resistance will be lost.)

Dimensions with Flush Mounting Adapter

H5CZ-L8□ (Adapter and Waterproof Packing Ordered Separately)

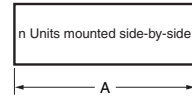
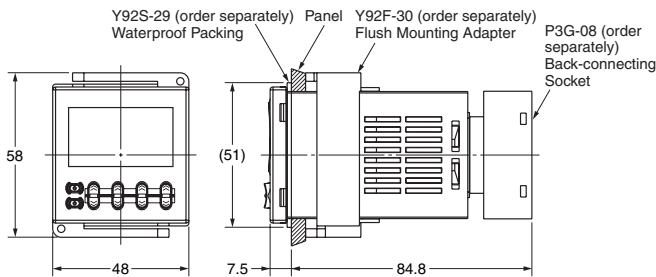

$$A = (48n - 2.5) \begin{matrix} +1 \\ -0 \end{matrix}$$

With Y92A-48F1 attached.

$$A = (48n - 2.5 + (n-1) \times 4) \begin{matrix} +1 \\ -0 \end{matrix}$$

With Y92A-48 attached.

$$A = (51n - 5.5) \begin{matrix} +1 \\ -0 \end{matrix}$$

Dimensions with Front Connecting Socket

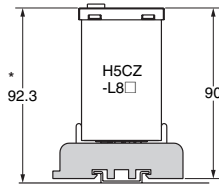

P2CF-08(-E) (order separately)
Front Connecting Socket

* These dimensions vary with the type of DIN track (reference value).

Accessories (Order Separately)

Note:

Depending on the operating environment, the condition of resin products may deteriorate, and may shrink or become harder. Therefore, it is recommended that resin products are replaced regularly.

Soft Cover
Y92A-48F1

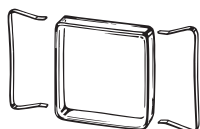

Hard Cover
Y92A-48

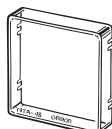

Protecting the Timer in Environments Subject to Oil

The H5CZ's panel surface is water-resistive (IP□6, UL Type 4X) and so even if drops of water penetrate the gaps between the keys, there will be no adverse effect on internal circuits. If, however, there is a possibility of oil being present on the operator's hands, use the Soft Cover. The Soft Cover ensures protection equivalent to IP54 against oil. Do not, however, use the H5CZ in locations where it would come in direct contact with oil.

Flush Mounting Adapter
Y92F-30

Order this Flush Mounting Adapter separately if it is required.

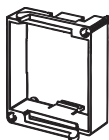

Waterproof Packing
Y92S-29



Order this Waterproof Packing separately if it is required. The Waterproof Packing can be used to achieve IP66 protection.

The Waterproof Packing will deteriorate, harden, and shrink depending on the application environment. To ensure maintaining the IP□6, UL Type 4X waterproof level, periodically replace the Waterproof Packing. The periodic replacement period will depend on the application environment. You must confirm the proper replacement period. Use 1 year or less as a guideline. If the Waterproof Packing is not replaced periodically, the waterproof level will not be maintained.

It is not necessary to mount the Waterproof Packing if waterproof construction is not required.

Connection Sockets Front-connecting Sockets

Model	Dimensions	Terminal arrangement and internal connections	Mounting hole dimensions
P2CF-08			<p>Note: The Socket can also be mounted to DIN track.</p>
P2CF-08-E (Finger Safe Terminal)		<p>(Top View)</p>	

Note: Round crimp terminals cannot be used on Finger-safe Sockets. Use forked crimp terminals.

Back-connecting Sockets

Model	Dimensions	Terminal arrangement and internal connections
P3G-08		<p>(Bottom View)</p>

Note: A Y92A-48G Terminal Cover can be used with the Socket to create a finger-safe construction.

Terminal Covers for P3G-08 Back-connecting Sockets

Model	Dimensions
Y92A-48G	

Note: The Terminal Cover can be used with a Back-mounting Socket (P3G-08) to create a finger-safe construction.

Optional Products for Track Mounting

Mounting Track
PFP-100N
PFP-50N

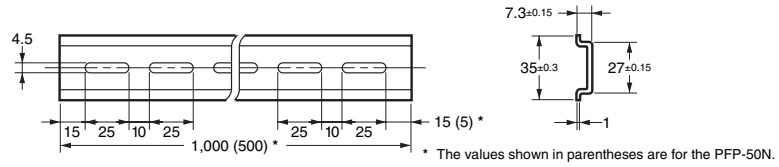
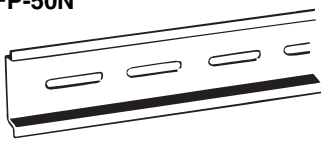

Mounting Track
PFP-100N2

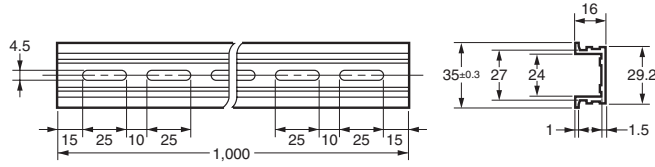
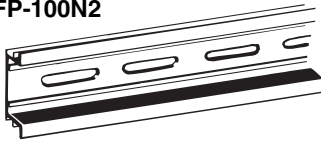

End Plate
PFP-M

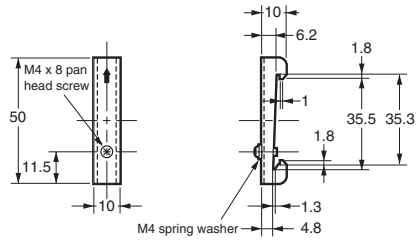
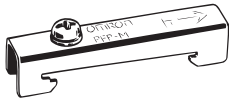

Spacer
PFP-S

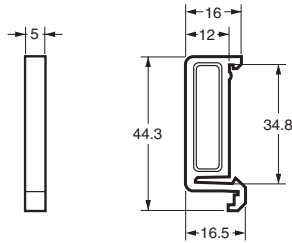
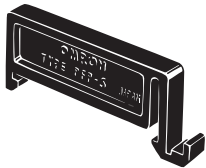

Note: Order Spacers in increments of 10.

Operating Procedures

Setting Procedure Guide

Settings for Timer Operation *

Use the following settings.

Settings for Twin Timer Operation *

Refer to **page 22**.

* At the time of delivery, the H5CZ is set to the Timer configuration. Refer to **page 25** for information on switching models.

Operating Procedures for Timer Function

- Change to Function Setting Mode.

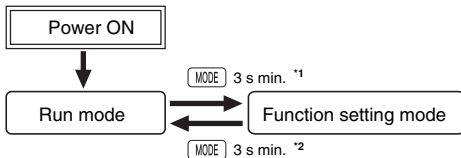

For details on operations in run mode, refer to **page 15**.

- *1. If the mode is switched to the function setting mode during operation, operation will continue.
- *2. Changes made to settings in function setting mode are enabled for the first time when the mode is changed to run mode. Also, when settings are changed, the timer is reset (time initialized and output turned OFF).

Function setting mode

The characters displayed in reverse video are the default settings.

- Set the time range using the \uparrow \downarrow keys.
 - For details, refer to the **Time Range List**.
- Set the timer mode using the \uparrow \downarrow keys.
 - (UP) (DOWN)
- Set the output mode using the \uparrow \downarrow keys.
 - Note:** Only modes **A-2**, b, E, and Z can be selected for models with instantaneous contact outputs.
- Set each digit for the output time using the corresponding \uparrow \downarrow keys.
 - (Output hold) (0.01s) (99.99s)
 - (If the output time is set to 0.00, **HôLd** is displayed.)
 - Note:** Displayed for modes A, A-1, A-2, A-3, b, b-1 and S only.
- Set the input signal width using the \uparrow \downarrow keys.
 - Note:** Not displayed for models with instantaneous contact outputs.
- Set the function (instantaneous or time-limit operation) for the instantaneous output (output 1) using the \uparrow \downarrow Keys.
 - (Instantaneous) (Time-limit)
 - Note:** Displayed only for models with instantaneous contact outputs.

Display	Set Value
	0.01 s to 99.99 s (default setting)
	0.1 s to 999.9 s
	1 s to 9999 s
	0 min 01 s to 99 min 59 s
	0.1 min to 999.9 min
	1 min to 9999 min
	0 h 01 min to 99 h 59 min
	0.1 h to 999.9 h
	1 h to 9999 h
	0.001 s to 9.999 s

From next page
To next page

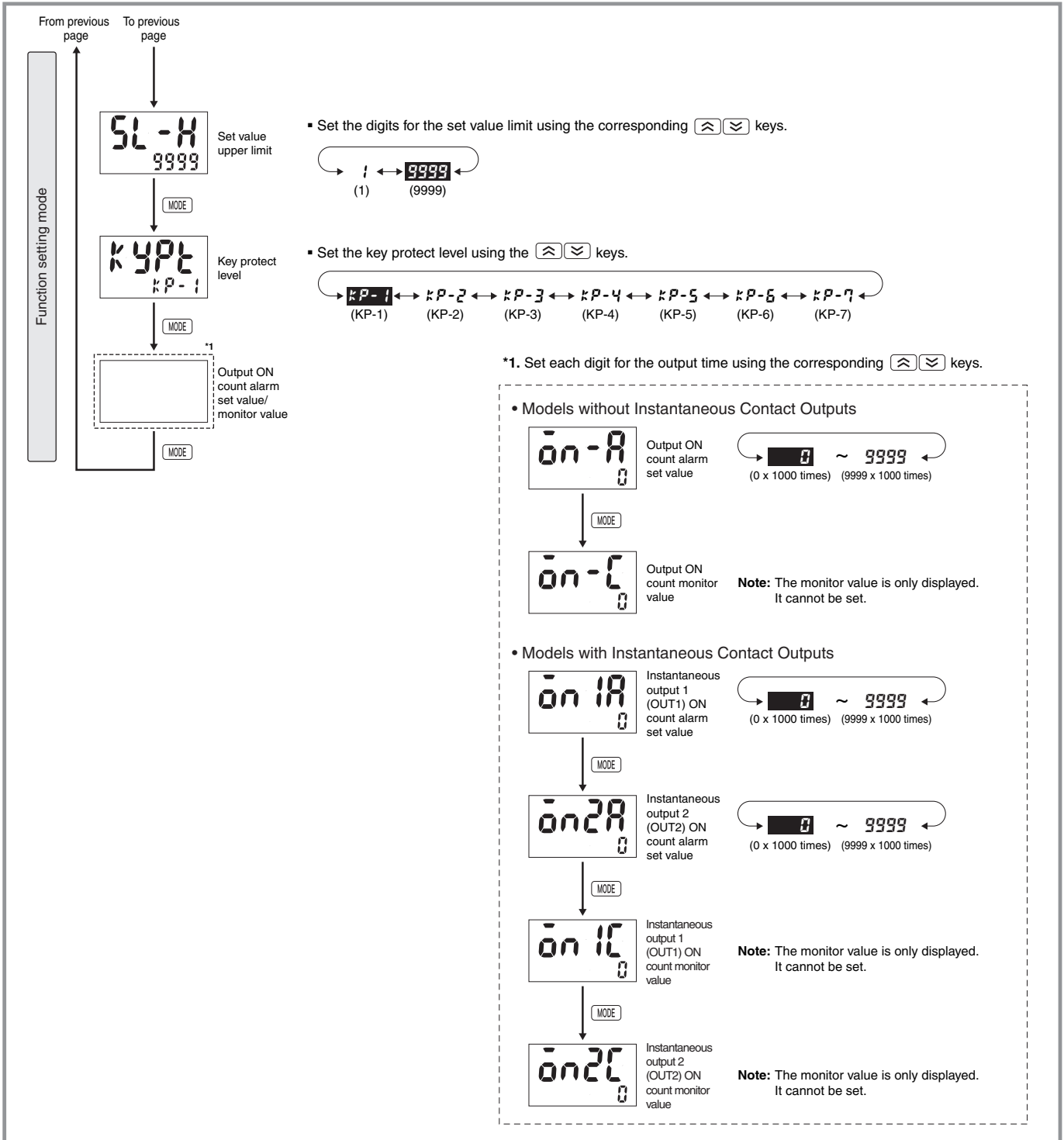

Explanation of Functions Operating Procedures for Timer Function

Time Range (t_{min} - t_{max})

Set the range to be timed in the range 0.001 s to 9,999 h.

Timer Mode (UP/DOWN)

Set either the elapsed time (UP) or remaining time (DOWN) mode. In UP mode, the elapsed time is displayed, and in DOWN mode, the remaining time is displayed.

Output Mode (A, A-1, A-2, A-3, b, b-1, d, E, F, Z and S)

Set the output mode. The possible settings are A, A-1, A-2, A-3, b, b-1, d, E, F, Z and S. (For details on output mode operation, refer to "Timing Charts" on page 16.)

Output Time (0.01 to 99.99 s)

When using one-shot output, set the output time for one-shot output (0.01 to 99.99 s).

One-shot output can be used only if the selected output mode is A, A-1, A-2, A-3, b, b-1 or S.

If the output time is set to 0.00, **Hold** is displayed, and the output is held.

Input Signal Width (20 ms or 1 ms)

Set the minimum signal input width (20 ms or 1 ms) for signal and reset inputs.

The same setting is used for all external inputs (signal and reset inputs).

If contacts are used for the input signal, set the input signal width to 20 ms.

Processing to eliminate chattering is performed for this setting.

Key Protect Level (High/Low)

Set the key protect level.

Refer to "Key Protect Level" on page 28.

Instantaneous/Time-limit (SPDT + instantaneous SPDT or time-limit SPDT operation)

Set the contact output to time-limit SPDT + instantaneous SPDT or time-limit SPDT operation.

Set Value Upper Limit (1 to 9999)

Set the upper limit for the set value when it is set in Run Mode.

The limit can be set to between 1 and 9999.

This setting does not apply to the ON duty in Z mode.

Output ON Count Alarm Set Value (0 to 9999 x 1000)

Set the alarm value for the output ON count.

The limit can be set to between 0 x 1000 (0 times) and 9999 x 1000 (9,999,000 times). Only the underlined values are set. The alarm will be disabled if 0 is set.

If the total ON count of the output exceeds the alarm set value, **EX** will be displayed on the Timer to indicate that the output ON count alarm value was exceeded. Refer to "Self-diagnostic Function" on page 28 for information on the **EX** display.

ON Count Alarm Set Values for Outputs 1 and 2 (OUT1 and OUT2) (0 to 9999 x 1000)

Set the ON count alarm values for the outputs 1 and 2.

The limit can be set to between 0 x 1000 (0 times) and 9999 x 1000 (9,999,000 times). Only the underlined values are set. The alarm will be disabled if 0 is set.

If the total ON count of instantaneous output 1 or 2 exceeds the alarm set value, **EX** will be displayed on the Timer to indicate that the output ON count alarm value was exceeded. Refer to "Self-diagnostic Function" on page 28 for information on the **EX** display.

Output ON Count Monitor Value (1000 to 9999 x 1000)

The monitor value is only displayed. It cannot be set.

The output ON count will be 1,000 times the displayed value.

ON Count Monitor Values for Outputs 1 and 2 (OUT1 and OUT2) (1000 to 9999 x 1000)

The monitor value for output 1 or 2 is only displayed. It cannot be set.

The output ON count will be 1,000 times the displayed value.

Operation in Run Mode

Operating Procedures for Timer Function

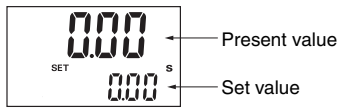

- Set each digit for the output time using the corresponding \uparrow \downarrow keys.



Note: H5CZ-L8E Precautions

Set the Timer's set value before using the Timer in a self-holding circuit.

- When Output Mode Z Is Selected

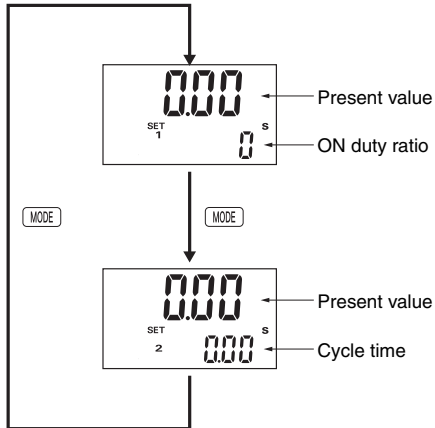

- Set each digit for the output time using the corresponding \uparrow \downarrow keys. (The \uparrow \downarrow keys for the 4th digit cannot be used.)



- Set each digit for the output time using the corresponding \uparrow \downarrow keys.



Timing Charts Operating Procedures for Timer Function Models without Instantaneous Contact Outputs

 Either one-shot output or sustained output can be selected.

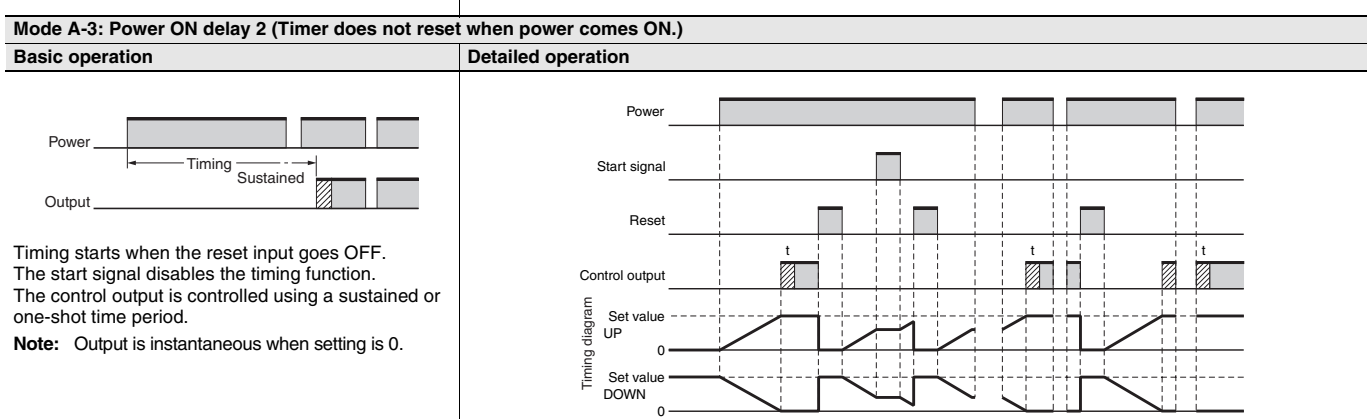
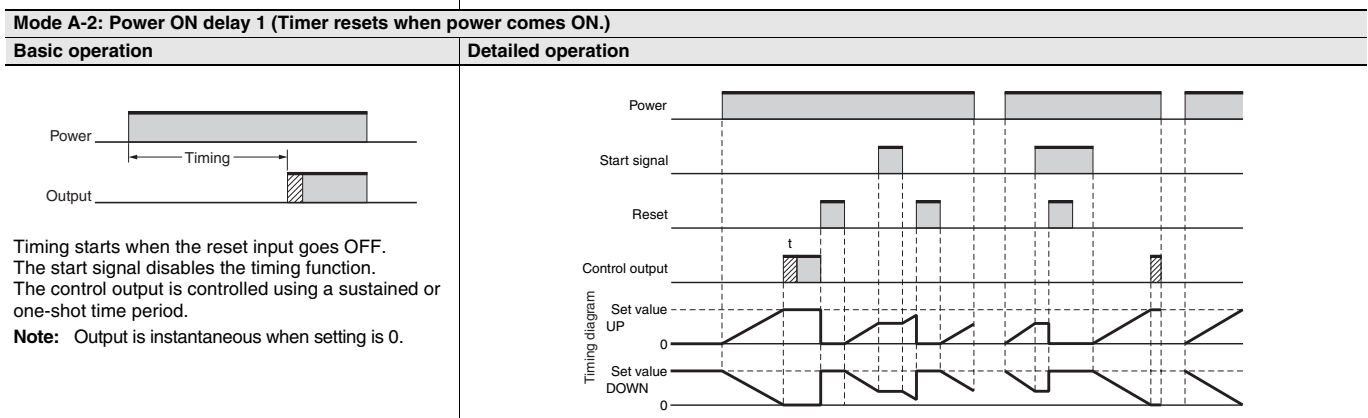
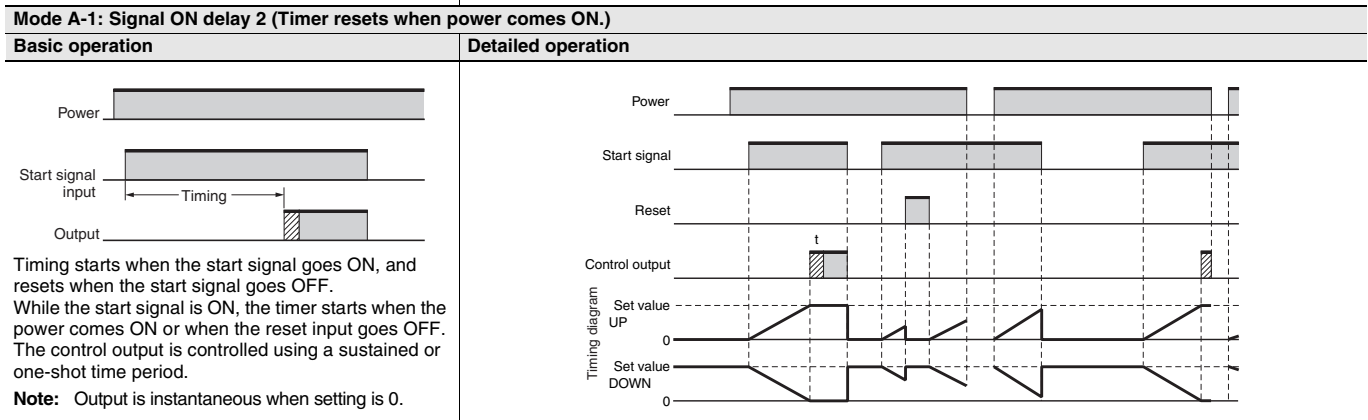
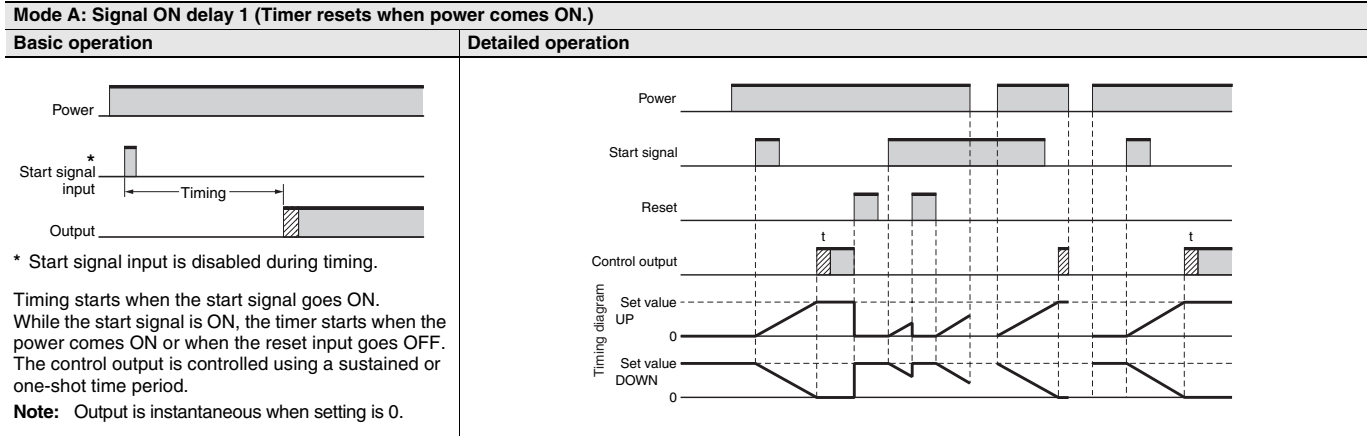

Mode b: Repeat cycle 1 (Timer resets when power comes ON.)

Basic operation

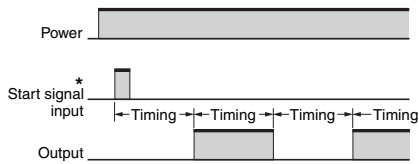

* Start signal input is disabled during timing.

Timing starts when the start signal goes ON.
The status of the control output is reversed when time is up (OFF at start).

While the start signal is ON, the timer starts when the power comes ON or when the reset input goes OFF.

Note: Normal output operation will not be possible if the set time is too short.
Set the value to at least 100 ms (contact output type).

Detailed operation

Sustained Output

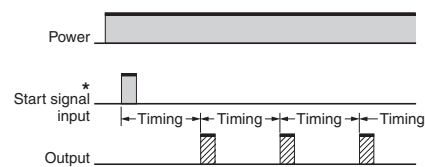
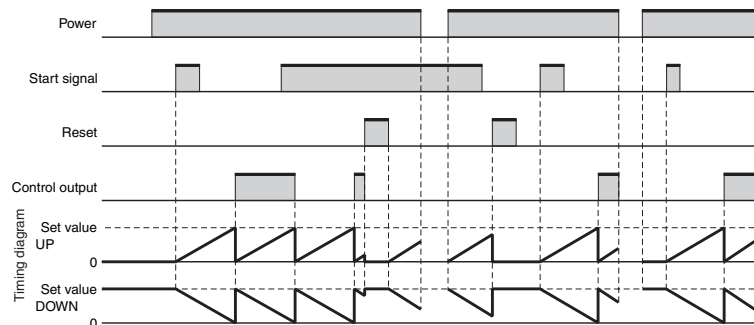

* Start signal input is disabled during timing.

Timing starts when the start signal goes ON.
The control output is turned ON when time is up.

While the start signal is ON, the timer starts when the power comes ON or when the reset input goes OFF.
Note: Normal output operation will not be possible if the set time is too short.
Set the value to at least 100 ms (contact output type).

One-shot Output

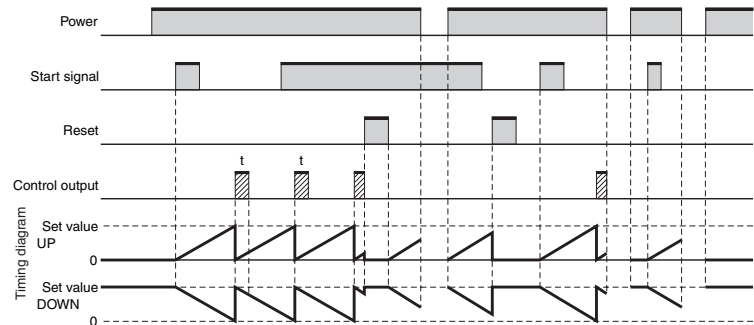

Mode b-1: Repeat cycle 2 (Timer does not reset when power comes ON.)

Basic operation

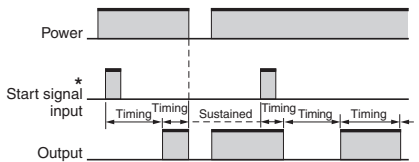

* Start signal input is disabled during timing.

Timing starts when the start signal goes ON.
The status of the control output is reversed when time is up (OFF at start).

While the start signal is ON, the timer starts when the power comes ON or when the reset input goes OFF.

Note: Normal output operation will not be possible if the set time is too short.
Set the value to at least 100 ms (contact output type).

Detailed operation

Sustained Output

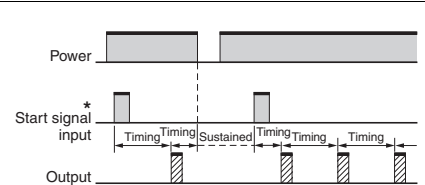
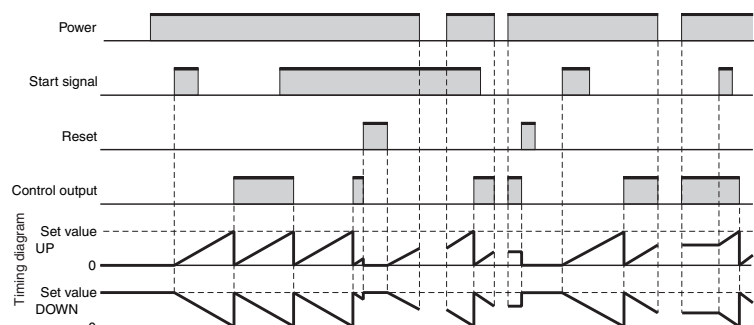

* Start signal input is disabled during timing.

Timing starts when the start signal goes ON.
The control output is turned ON when time is up.

While the start signal is ON, the timer starts when the power comes ON or when the reset input goes OFF.
Note: Normal output operation will not be possible if the set time is too short.
Set the value to at least 100 ms (contact output type).

One-shot Output

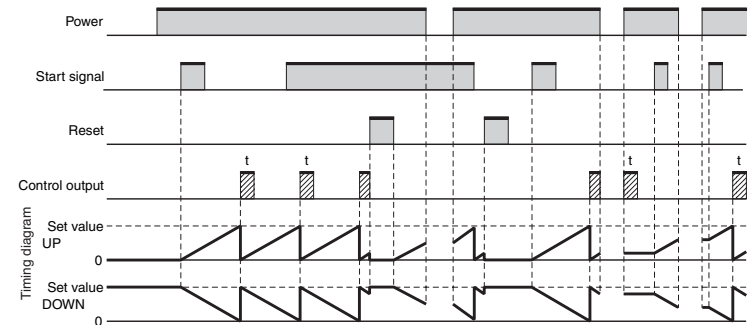

H5CZ Timer

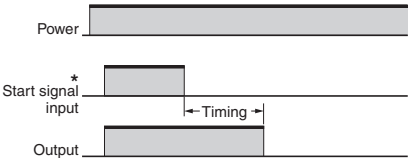
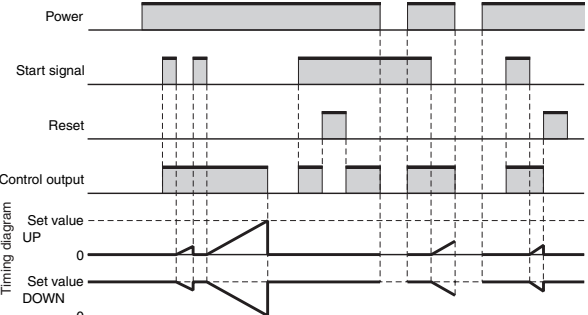
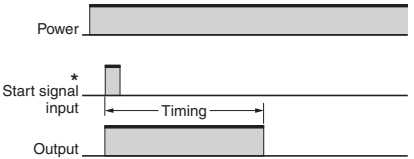
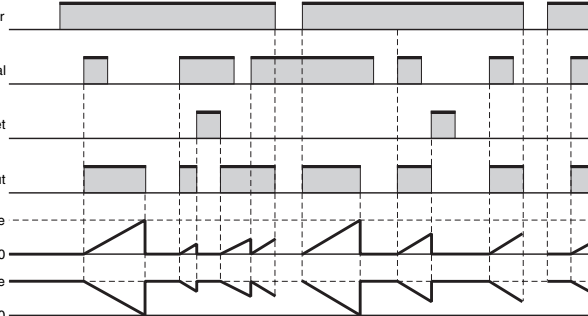
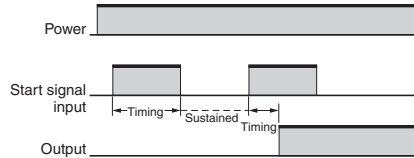
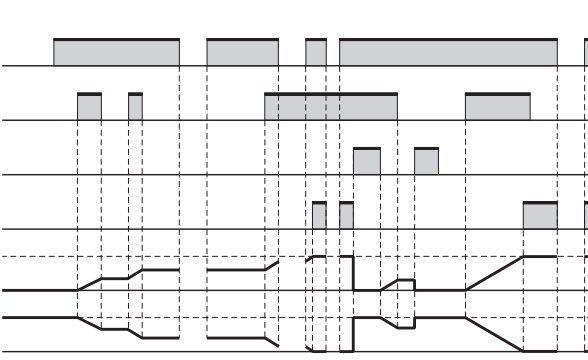
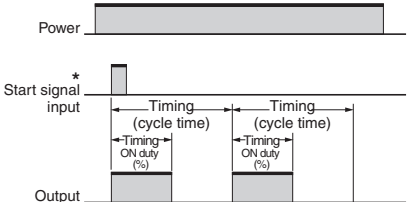
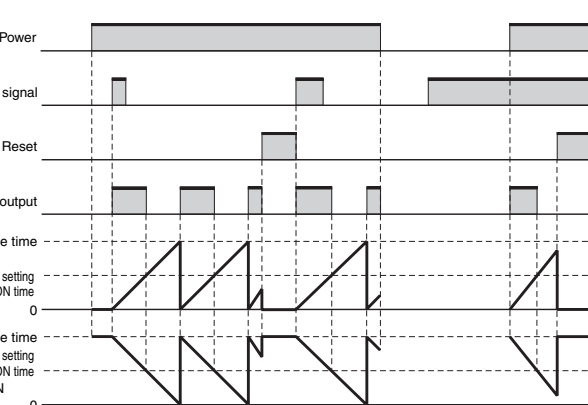
Mode d: Signal OFF delay (Timer resets when power comes ON.)	
Basic operation	Detailed operation
 <p>* Start signal input is enabled during timing.</p> <p>The control output is ON when the start signal is ON (except when the power is OFF or the reset is ON). The timer resets when the time is up.</p> <p>Note: Output functions only during start signal input when setting is 0.</p>	
Mode E: Interval (Timer resets when power comes ON.)	
Basic operation	Detailed operation
 <p>* Start signal input is enabled during timing.</p> <p>Timing starts when the start signal comes ON. The timer resets when the time is up. While the start signal is ON, the timer starts when the power comes ON or when the reset input goes OFF.</p> <p>Note: Output is disabled when the setting is 0.</p>	
Mode F: Cumulative (Timer does not reset when power comes ON.)	
Basic operation	Detailed operation
 <p>Start signal enables timing (timing is stopped when the start signal is OFF or when the power is OFF). A sustained control output is used.</p> <p>Note: Output is instantaneous when setting is 0.</p> <p>When the H5CZ is used with power start in mode F (i.e., cumulative operation with output on hold), there will be a timer error (approximately 100 ms each time the H5CZ is turned ON) due to the characteristics of the internal circuitry. Use the H5CZ with signal start if timer accuracy is required.</p>	
Mode Z: ON/OFF-duty-adjustable flicker (Timer resets when power comes ON.)	
Basic operation	Detailed operation
 <p>* Start signal input is disabled during timing.</p> <p>Timing starts when the start signal goes ON. The status of the control output is reversed when time is up (ON at start). While the start signal is ON, the timer starts when power comes ON or when the reset input goes OFF.</p> <p>Note: Normal output operation will not be possible if the set time is too short. Set the value to at least 100 ms (contact output type).</p>	

Mode S: Stopwatch (Timer resets when power comes ON.)

Basic operation

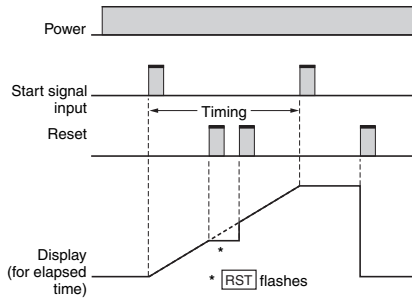

The signal starts and stops timing.
The display is held and timing is continued if the reset is received during timing operation.
The timer resets if the reset is received when the timing operation is stopped.

Note: Output is instantaneous when setting is 0.

Detailed operation

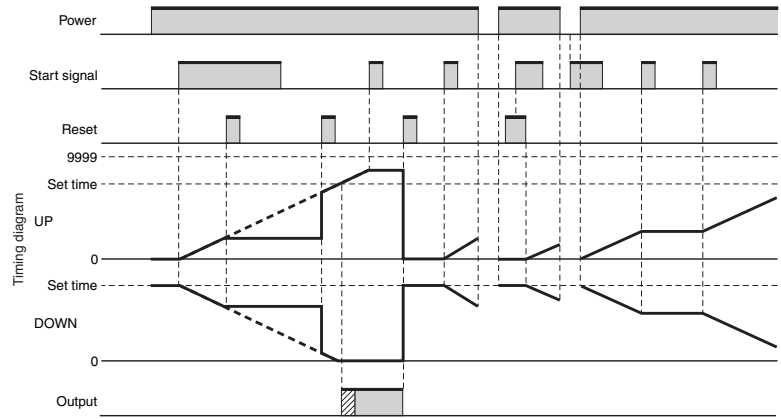

H5CZ Timer

Models with Instantaneous Contact Outputs

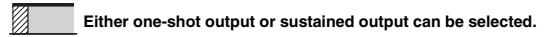
 Either one-shot output or sustained output can be selected.

Mode A-2: Power ON delay (Timer resets when power comes ON.)

Basic operation

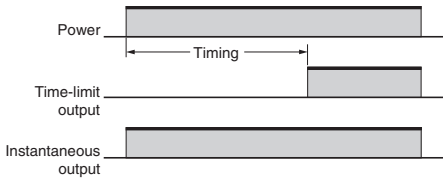

The Timer starts when the power comes ON or when the reset input goes OFF.

Note: Output is instantaneous when setting is 0.

Detailed operation

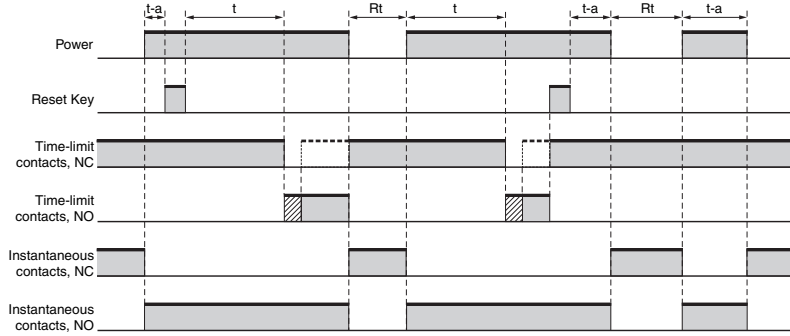

Mode b: Repeat cycle 1 (Timer resets when power comes ON.)

Basic operation

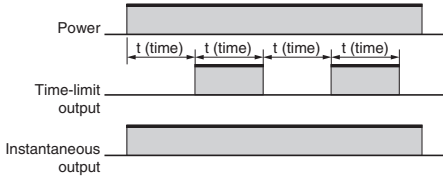

The Timer starts when the power comes ON or when the reset input goes OFF.

Note: Normal output operation will not be possible if the set time is too short. Set the value to at least 100 ms.

Detailed operation

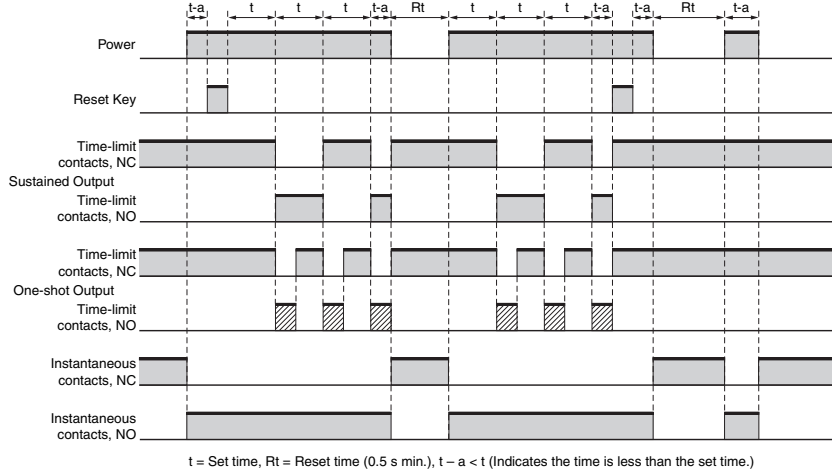

Note: H5CZ-L8E Precautions

Set the Timer's set value before using the Timer in a self-holding circuit.

Mode E: Interval (Timer resets when power comes ON.)

Basic operation

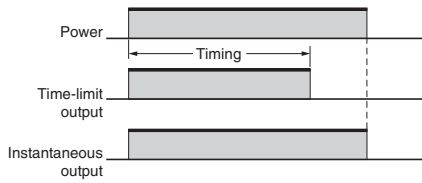

The Timer starts when the power comes ON or when the reset input goes OFF.

Note: Output is not instantaneous when setting is 0.

Detailed operation

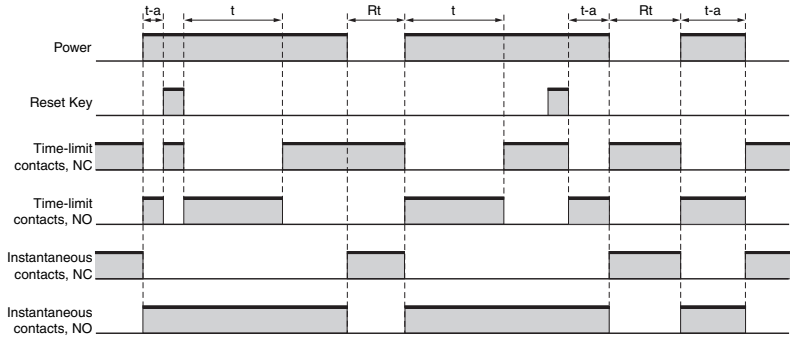

t = Set time, Rt = Reset time (0.5 s min.), $t - a < t$ (Indicates the time is less than the set time.)

Mode Z: ON/OFF-duty adjustable flicker (Timer resets when power comes ON.)

Basic operation

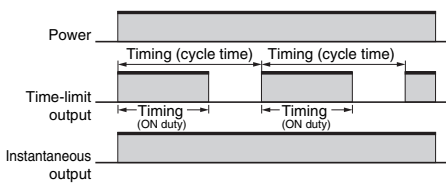

The Timer starts when the power comes ON or when the reset input goes OFF.

Note: Normal output operation will not be possible if the set time is too short.
Set the value to at least 100 ms.

Detailed operation

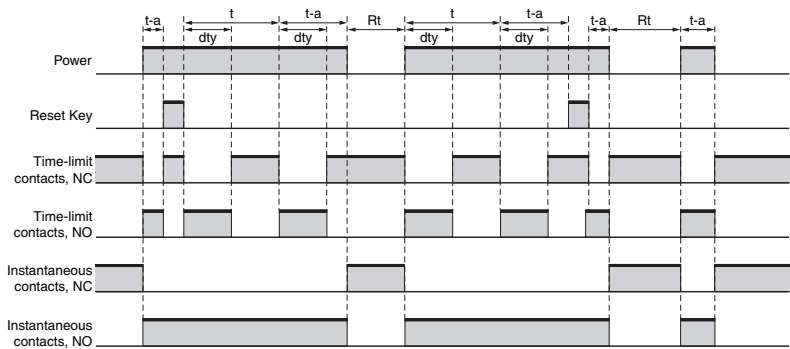

t = Set time, dty = ON duty time, Rt = Reset time (0.5 s min.), $t - a < t$ (Indicates the time is less than the set time.)

Note: H5CZ-L8E Precautions

Set the Timer's set value before using the Timer in a self-holding circuit.

Setting Procedure Guide Operating Procedures for Twin Timer Function

Step1 Switching to a Twin Timer

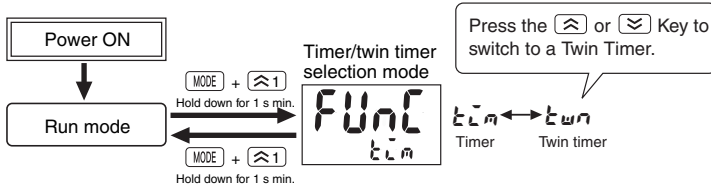

To switch to twin timer operation, use the procedure given below. For details, refer to page 27.

Step2

- Change to Function Setting Mode.

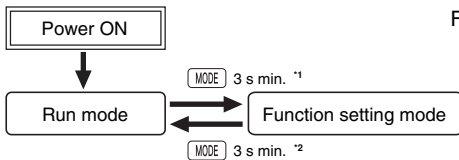

For details on operations in run mode, refer to page 24.

- *1. If the mode is switched to the function setting mode during operation, operation will continue.
- *2. Changes made to settings in function setting mode are enabled for the first time when the mode is changed to run mode. Also, when settings are changed, the timer is reset (time initialized and output turned OFF).

Function setting mode

The characters displayed in reverse video are the default settings.

- Set the OFF time range using the [F1] [F2] keys.
 - For details, refer to **Time Range List**.
- Set the ON time range using the [F1] [F2] keys.
 - For details, refer to **Time Range List**.
- Set the timer mode using the [F1] [F2] keys.
 - UP (UP) ↔ DOWN (DOWN)
- Set the twin timer output mode using the [F1] [F2] keys.
 - töFF ↔ tön ↔ töF1 ↔ tön1
 - (Flicker OFF start 1) (Flicker ON Start 1) (Flicker OFF start 2) (Flicker ON Start 2)
 - Note:** Only Flicker OFF Start 1 or Flicker ON Start 1 can be selected for the H5CZ-L8E□.
- Set the input signal width using the [F1] [F2] keys.
 - 20ms (20 ms) ↔ 1ms (1 ms)
 - Note:** Not displayed for models with instantaneous contact outputs.

Time Range List	
Display	Set Value
-. -. s	0.01 s to 99.99 s (default setting)
-. -. s	0.1 s to 999.9 s
-. -. s	1 s to 9999 s
-. -. ms	0 min 01 s to 99 min 59 s
-. -. m	0.1 min to 999.9 min
-. -. m	1 min to 9999 min
-. -. hm	0 h 01 min to 99 h 59 min
-. -. h	0.1 h to 999.9 h
-. -. h	1 h to 9999 h
-. -. s	0.001 s to 9.999 s

To next page From next page

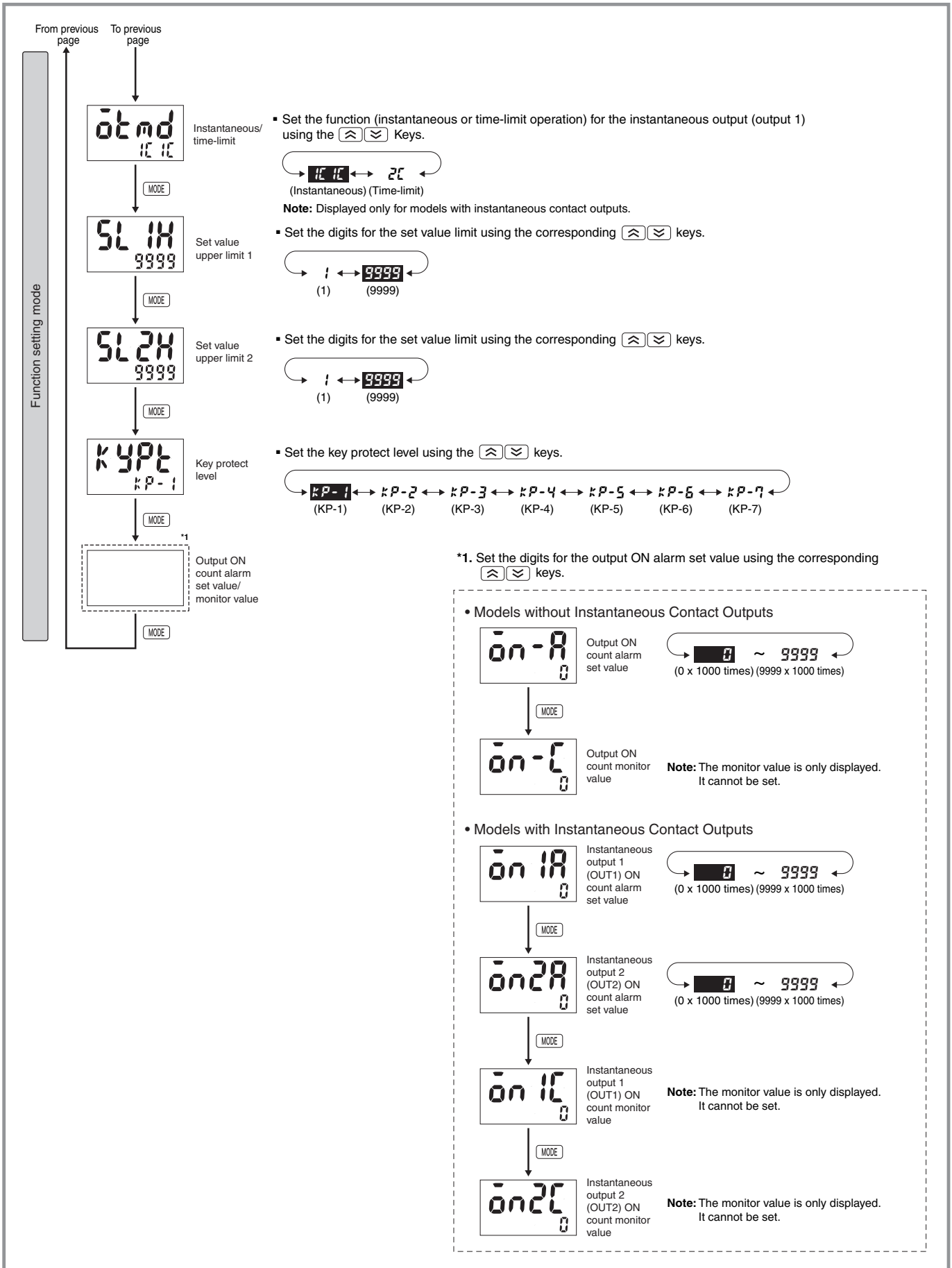

H5CZ Twin Timer

Explanation of Functions

Operating Procedures for Twin Timer Function

OFF Time Range (OFF)

Set the time range for the OFF time in the range 0.000 s to 9,999 h.

ON Time Range (ON)

Set the time range for the ON time in the range 0.001 s to 9,999 h.

Timer Mode (MODE)

Set either the elapsed time (UP) or remaining time (DOWN) mode. In UP mode, the elapsed time is displayed, and in DOWN mode, the remaining time is displayed.

Twin Timer Output Mode (MODE)

Set the output mode. Set either flicker OFF start or flicker ON start. (For details on output mode operation, refer to "Timing Charts" on page 25.)

Input Signal Width (FLT)

Set the minimum signal input width (20 ms or 1 ms) for signal and reset inputs. The same setting is used for all external inputs (signal and reset inputs). If contacts are used for the input signal, set the input signal width to 20 ms. Processing to eliminate chattering is performed for this setting.

Key Protect Level (KPL)

Set the key protect level. Refer to "Key Protect Level" on page 28.

Operation in Run Mode

Operating Procedures for Twin Timer Function

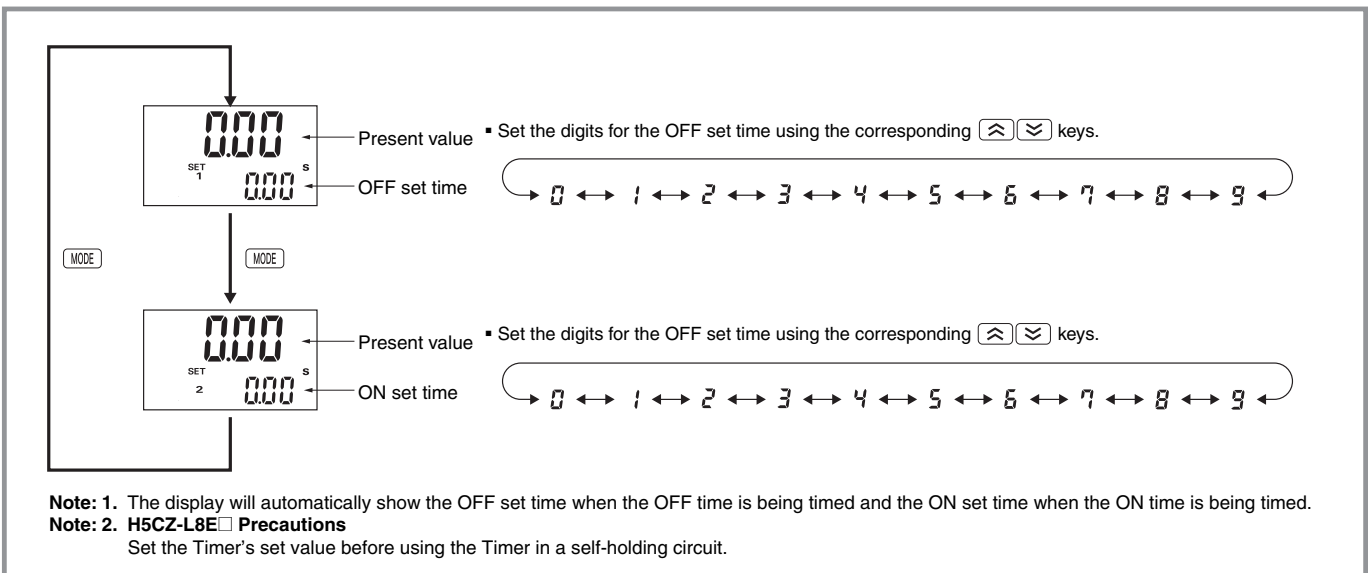

Present Value and OFF Set Time

The present value is displayed in the main display and the OFF set time is displayed in the sub-display. Set the OFF time.

Present Value and ON Set Time

The present value is displayed in the main display and the ON set time is displayed in the sub-display. Set the ON time.

Timing Charts

Operating Procedures for Timer Function

Models without Instantaneous Contact Outputs

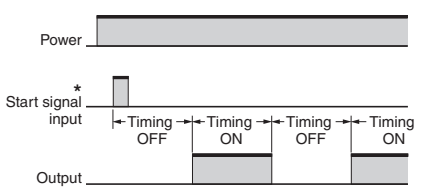
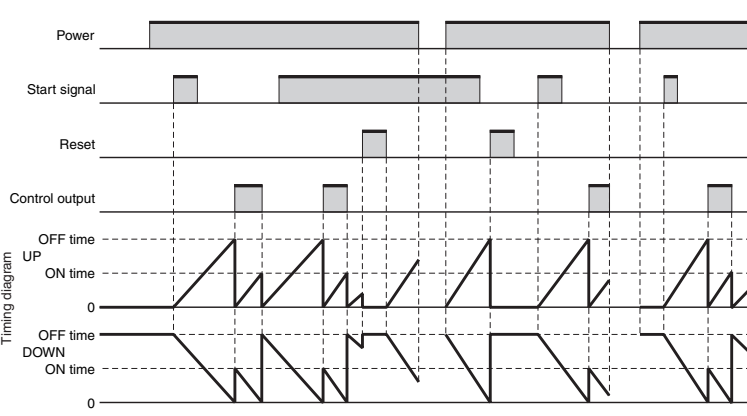
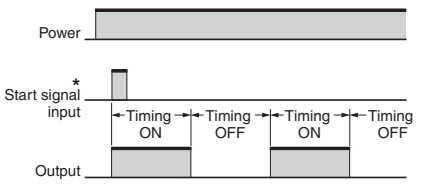
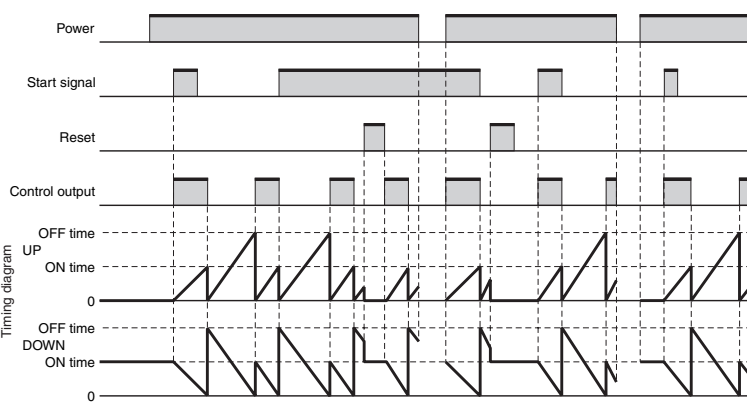
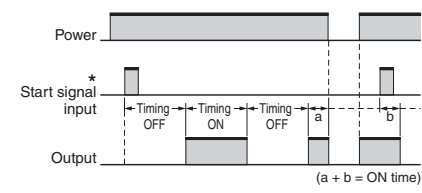
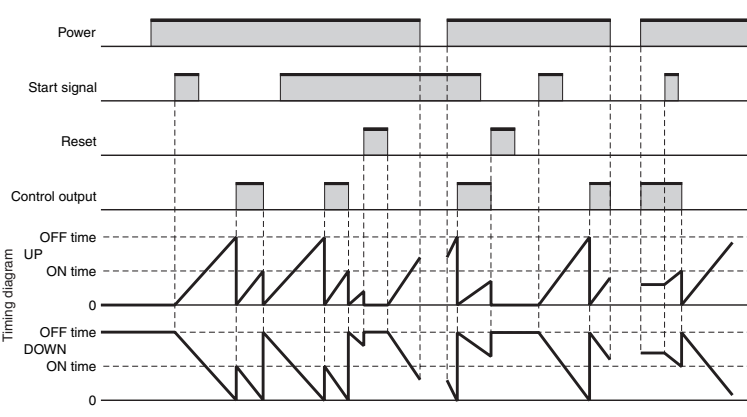
Mode toff: Flicker OFF start 1 (Timer resets when power comes ON.)	
Basic operation	Detailed operation
 <p>* Start signal input is disabled during timing.</p> <p>Timing starts when the start signal goes ON. The status of the control output is reversed when time is up (OFF at start). While the start signal is ON, the timer starts when the power comes ON or when the reset input goes OFF.</p> <p>Note: Normal output operation will not be possible if the set time is too short. Set the value to at least 100 ms (contact output type).</p>	
Mode ton: Flicker OFF start 1 (Timer resets when power comes ON.)	
Basic operation	Detailed operation
 <p>* Start signal input is disabled during timing.</p> <p>Timing starts when the start signal goes ON. The status of the control output is reversed when time is up (ON at start). While the start signal is ON, the timer starts when the power comes ON or when the reset input goes OFF.</p> <p>Note: Normal output operation will not be possible if the set time is too short. Set the value to at least 100 ms (contact output type).</p>	
Mode toff-1: Flicker OFF start 2 (Timer does not reset when power comes ON.)	
Basic operation	Detailed operation
 <p>* Start signal input is disabled during timing.</p> <p>Timing starts when the start signal goes ON. The status of the control output is reversed when time is up (OFF at start). While the start signal is ON, the timer starts when the power comes ON or when the reset input goes OFF.</p> <p>Note: Normal output operation will not be possible if the set time is too short. Set the value to at least 100 ms (contact output type).</p>	

H5CZ Twin Timer

Mode ton-1: Flicker ON start 2 (Timer does not reset when power comes ON.)

Basic operation

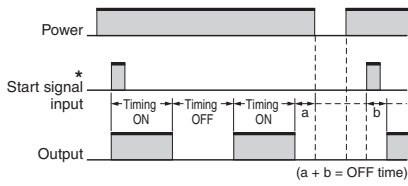

*Start signal input is disabled during timing.

Timing starts when the start signal goes ON.
The status of the control output is reversed when time is up (ON at start).

While the start signal is ON, the timer starts when the power comes ON or when the reset input goes OFF.

Note: Normal output operation will not be possible if the set time is too short.
Set the value to at least 100 ms (contact output type).

Detailed operation

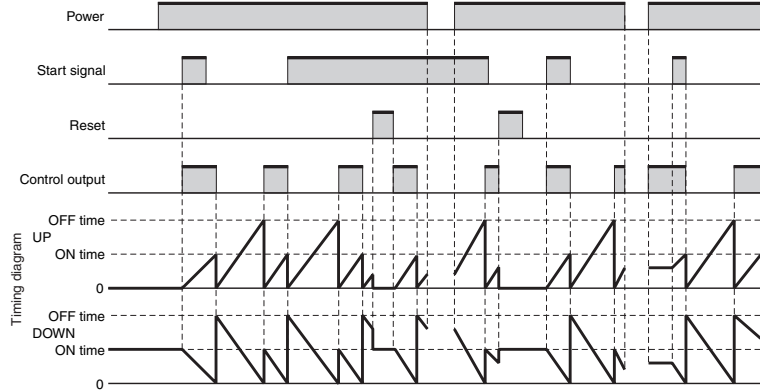

Models with Instantaneous Contact Outputs

Mode toff: Flicker OFF start 1 (Timer resets when power comes ON.)

Basic operation

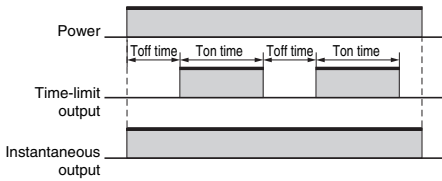

The Timer starts when the power comes ON or when the reset input goes OFF.

Note: Normal output operation will not be possible if the set time is too short.
Set the ON time and OFF time to at least 100 ms.

Detailed operation

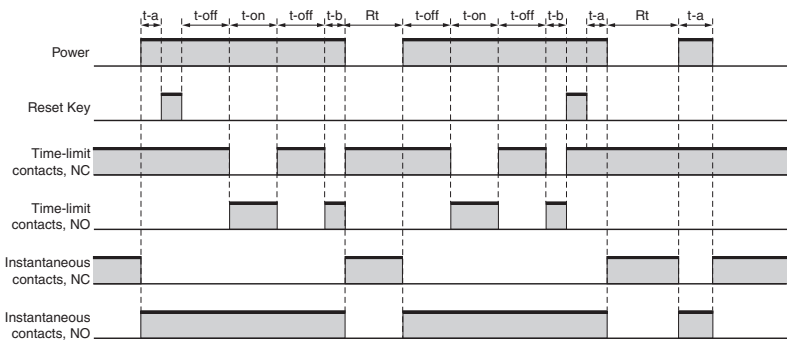

t-on = ON time, t-off = OFF time, Rt = Reset time (0.1 s min.), t-a < t-off and t-b < t-on
(Indicates the time is less than the set time.)

Mode ton: Flicker ON start 1 (Timer resets when power comes ON.)

Basic operation

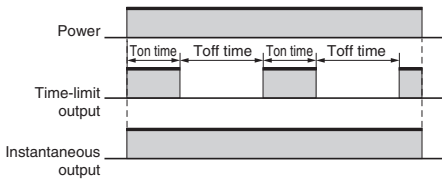

The Timer starts when the power comes ON or when the reset input goes OFF.

Note: Normal output operation will not be possible if the set time is too short.
Set the ON time and OFF time to at least 100 ms.

Detailed operation

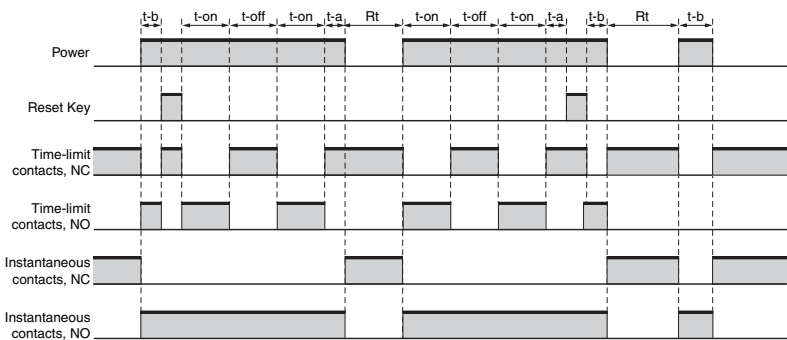

t-on = ON time, t-off = OFF time, Rt = Reset time (0.1 s min.), t-a < t-off and t-b < t-on
(Indicates the time is less than the set time.)

Note: H5CZ-L8E□ Precautions

Set the Timer's set value before using the Timer in a self-holding circuit.

Timer/Twin Timer Selection Mode (Configuration Selection)

Select whether the H5CZ is used as a timer or a twin timer in timer/twin timer selection mode.

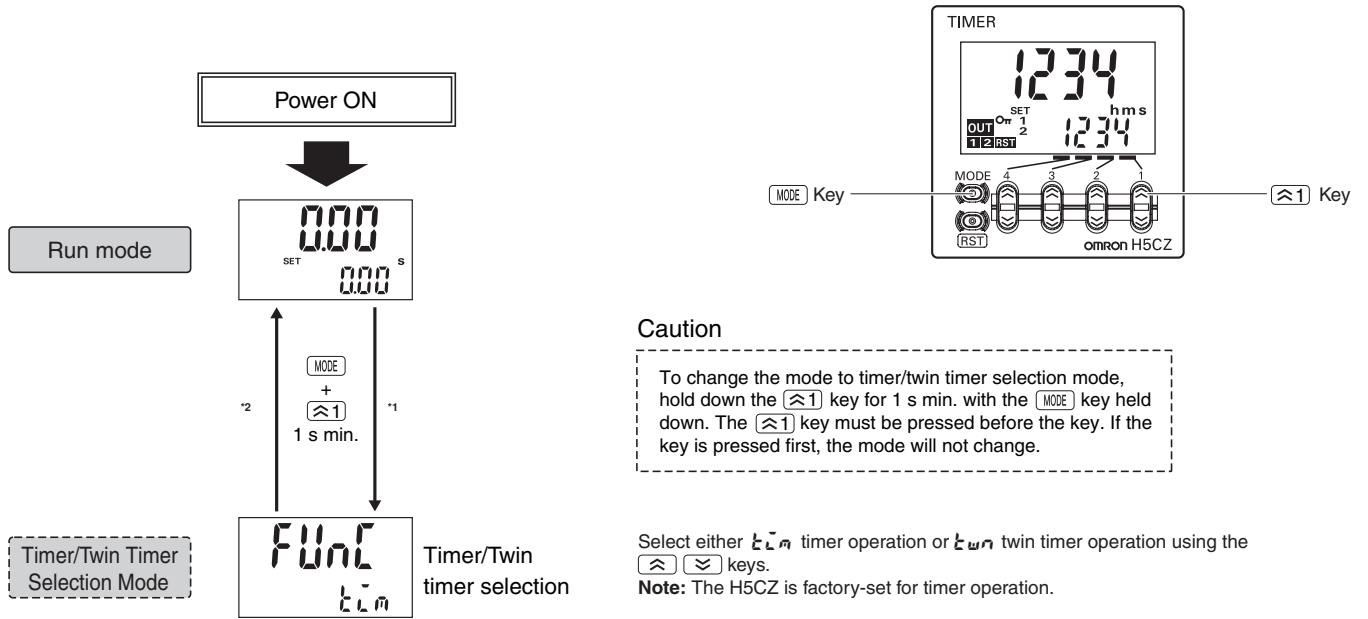

- *1. When the mode is changed to timer/twin timer selection mode, the present value is reset and output turns OFF. Timing operation is not performed in timer/twin timer selection mode.
- *2. Setting changes made in timer/twin timer selection mode are enabled when the mode is changed to run mode. If settings are changed, the H5CZ is automatically reset (present value initialized, output turned OFF).

Key Protect Level

When the key-protect switch is set to ON, it is possible to prevent setting errors by prohibiting the use of certain operation keys by specifying the key protect level (KP-1 to KP-7).

The key protect indicator is lit while the key-protect switch is set to ON.

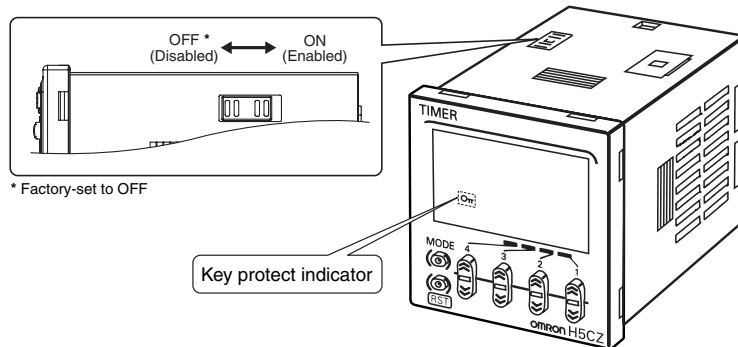

Level	Meaning	Details			
		Changing mode*	Switching display during operation	Reset Key	Up/down key
KP-1 (default setting)		Invalid	Valid	Valid	Valid
KP-2		Invalid	Valid	Invalid	Valid
KP-3		Invalid	Valid	Valid	Invalid
KP-4		Invalid	Valid	Invalid	Invalid
KP-5		Invalid	Invalid	Invalid	Invalid
KP-6		Invalid	Invalid	Valid	Valid
KP-7		Invalid	Invalid	Invalid	Valid

* Changing mode to Timer/Twin Timer Selection Mode or Function Setting Mode.

Self-diagnostic Function

The following displays will appear if an error occurs.

Main display	Sub-display	Error	Output status	Correction method	Set value after reset
E1	Not lit	CPU	OFF	Either press the reset key or reset the power supply.	No change
E2	Not lit	Memory error (RAM)	OFF	Reset the power supply.	No change
E2	SUm	Memory error EEPROM *1	OFF	Reset Key	Factory setting
E3 *2	No change	Output ON count alarm set value exceeded	No change	Reset Key	No change

*1. This includes times when the life of the EEPROM has expired.

*2. The normal display and E3 will appear alternately.

When the Reset Key is pressed, E3 will no longer be displayed even if the alarm set value is exceeded. (Monitoring is possible, however, because the Timer will continue without clearing the output ON count.)

Safety Precautions for All H5CZ Series (Common)

⚠ CAUTION

Do not allow pieces of metal, wire clippings, or fine metallic shavings or fillings from installation to enter the product. Doing so may occasionally result in electric shock, fire, or malfunction.



Minor injury due to explosion may occasionally occur. Do not use the Timer where subject to flammable or explosive gas.



Fire may occasionally occur. Tighten the terminal screws to the rated torque.
P2CF Socket terminals: 4.4 lb-in (0.5 N·m)



Minor injury due to electric shock may occasionally occur. Do not touch any of the terminals while power is being supplied. Be sure to mount the terminal cover after wiring.



The life expectancy of the output relay varies considerably according to its usage. Use the output relay within its rated load and electrical life expectancy. If the output relay is used beyond its life expectancy, its contacts may become fused or there may be a risk of fire. Also, be sure that the load current does not exceed the rated load current and when using a heater, be sure to use a thermal switch in the load circuit.



Minor electric shock, fire, or malfunction may occasionally occur. Do not disassemble, modify, or repair the Timer or touch internal components.



Precautions for Safe Use

- The panel surface of the H5CZ is water-resistant (conforming to NEMA4, IP66, UL Type 4X (Indoor Use Only). To protect the internal circuits from water penetration through the space between the H5CZ and operating panel, waterproof packing is included. Attach the Y92F-30 Adapter with sufficient pressure with the reinforcing screws so that water does not penetrate the panel.

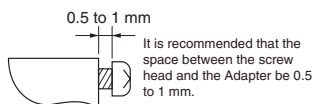

- When mounting the Timer to a panel, tighten the two mounting screws alternately, a little at a time, so as to keep them at an equal tightness. If the panel screws are tightened unequally, water may enter the panel.
- Store the Timer at the specified temperature. If the Time has been stored at a temperature of less than -10°C , allow the Time to stand at room temperature for at least 3 hours before use.
- Mounting the Timer side-by-side may reduce the life expectancies of internal components.
- Use the Timer within the specified ranges for the ambient operating temperature and humidity.
- Do not use in the following locations:
 - Locations subject to sudden or extreme changes in temperature.
 - Locations where high humidity may result in condensation.
- Do not use the Timer outside of the rated ranges for vibration, shock, water exposure, and oil exposure.
- Do not use this Timer in dusty environments, in locations where corrosive gasses are present, or in locations subject to direct sunlight.
- Install the Timer well away from any sources of static electricity, such as pipes transporting molding materials, powders, or liquids.

- Internal elements may be destroyed if a voltage outside the rated voltage range is applied.
- Be sure that polarity is correct when wiring the terminals.
- Separate the Timer from sources of noise, such as devices with input signals from power lines carrying noise, and wiring for I/O signals.
- Do not connect more than two crimp terminals to the same terminal.
- Up to two wires of the same size and type can be inserted into a single terminals.
- Use the specified wires for wiring. Applicable Wires: AWG 18 to AWG 22, solid or twisted, copper.
- Install a switch or circuit breaker that allows the operator to immediately turn OFF the power, and label it to clearly indicate its function.
- Approximately 14 V is output from the input terminals. Use a sensor that contains a diode.

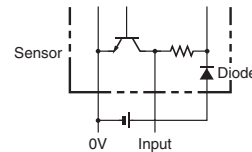

- Use a switch, relay, or other contact so that the rated power supply voltage will be reached within 0.1 seconds. If the power supply voltage is not reached quickly enough, the Timer may malfunction or outputs may be unstable.
- Use a switch, relay, or other contact to turn the power supply OFF instantaneously. Outputs may malfunction and memory errors may occur if the power supply voltage is decreased gradually.
- When changing the set value during a timing operation, the output will turn ON if the set value is changed as follows because of the use of a constant read-in system:
 - Elapsed time (UP) mode: Present value \geq Set value
 - Remaining time (DOWN) mode: Elapsed time \geq Set value (The present value is set to 0.)
 When in the remaining time mode, the amount the set value is changed is added to or subtracted from the present value. Operation with a set value of 0 will vary with the output mode. Refer to the timing charts on **page 16**.
- Do not use organic solvents (such as paint thinners or benzene), strong alkali, or strong acids. They will damage the external finish.
- Confirm that indications are working normally, including the LCD. The indicator LCD, and resin parts may deteriorate more quickly depending on the application environment, preventing normal indications. Periodic inspection and replacement are required.
- The waterproof packing may deteriorate, shrink, or harden depending on the application environment. Periodic inspection and replacement are required.

Precautions for Correct Use

- H5CZ models with a 24-VDC/12 to 24-VDC power supply use a transformer-free power supply method in which the power supply terminals are not isolated from the signal input terminals. If a non-isolating DC power supply is used, unwanted current paths may occasionally burn or destroy internal components depending on the wiring. Always check the wiring sufficiently before use.
- An inrush current of approx. 10 A will flow for a short time when the power supply is turned ON. If the capacity of the power supply is not sufficient, the Timer may not start. Be sure to use a power supply with sufficient capacity.
- Maintain voltage fluctuations in the power supply within the specified operating voltage range.
- When turning the power ON and OFF, input signal reception is possible, unstable, or impossible as shown in the diagram below.

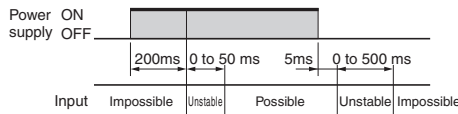

- To allow for the startup time of peripheral devices (sensors, etc.), the Timer starts timing operation between 200 to 250 ms after power is turned ON. For this reason, in operations where timing starts from power ON, the time display will actually start from 249 ms. If the set value is 249 ms or less, the time until output turns ON will be a fixed value between 200 and 250. The present value display will start from 250 ms. (Normal operation is possible for set values of 250 ms or more.) In applications where a set value of 249 ms or less is required, use start timing with signal input.
- Inrush current generated by turning ON or OFF the power supply may deteriorate contacts on the power supply circuit. Turn ON or OFF to a device with the rated current of more than 10 A.
- Make sure that all settings are appropriate for the application. Unexpected operation resulting in property damage or accidents may occur if the settings are not appropriate.
- Do not leave the Timer for long periods at a high temperature with output current in the ON state. Doing so may result in the premature deterioration of internal components (e.g., electrolytic capacitors).
- EEPROM is used as backup memory when the power is interrupted. The write life of the EEPROM is 100,000 writes. The EEPROM is written at the following times:
 - When the power supply is turned OFF
 - When switching from Timer/Twin Timer Selection Mode or Function Setting Mode to Run Mode
- Dispose of the product according to local ordinances as they apply.

⚠ Conformance to EN/IEC Standards

- When conforming to EMC standards, refer to the information provided in this datasheet for cable selection and other conditions.
- This is a class A product. In residential areas it may cause radio interference, in which case the user may be required to take adequate measures to reduce interference.
- Basic insulation is provided between the power supply and input terminals. (No insulation is provided between the power supply and input terminals for the H5CZ-L8D.) Basic insulation is provided between power supply and output terminals, and between input and output terminals.
- When double insulation or reinforced insulation is required, apply double insulation or reinforced insulation as defined in IEC 60664 that is suitable for the maximum operating voltage with clearances or solid insulation.
- Connect the input and output terminals to devices that do not have any exposed charged parts.

Warranty and Application Considerations

Read and Understand This Catalog

Please read and understand this catalog before purchasing the products. Please consult your OMRON representative if you have any questions or comments.

Warranty and Limitations of Liability

WARRANTY

OMRON's exclusive warranty is that the products are free from defects in materials and workmanship for a period of one year (or other period if specified) from date of sale by OMRON.

OMRON MAKES NO WARRANTY OR REPRESENTATION, EXPRESS OR IMPLIED, REGARDING NON-INFRINGEMENT, MERCHANTABILITY, OR FITNESS FOR PARTICULAR PURPOSE OF THE PRODUCTS. ANY BUYER OR USER ACKNOWLEDGES THAT THE BUYER OR USER ALONE HAS DETERMINED THAT THE PRODUCTS WILL SUITABLY MEET THE REQUIREMENTS OF THEIR INTENDED USE. OMRON DISCLAIMS ALL OTHER WARRANTIES, EXPRESS OR IMPLIED.

LIMITATIONS OF LIABILITY

OMRON SHALL NOT BE RESPONSIBLE FOR SPECIAL, INDIRECT, OR CONSEQUENTIAL DAMAGES, LOSS OF PROFITS, OR COMMERCIAL LOSS IN ANY WAY CONNECTED WITH THE PRODUCTS, WHETHER SUCH CLAIM IS BASED ON CONTRACT, WARRANTY, NEGLIGENCE, OR STRICT LIABILITY.

In no event shall the responsibility of OMRON for any act exceed the individual price of the product on which liability is asserted. IN NO EVENT SHALL OMRON BE RESPONSIBLE FOR WARRANTY, REPAIR, OR OTHER CLAIMS REGARDING THE PRODUCTS UNLESS OMRON'S ANALYSIS CONFIRMS THAT THE PRODUCTS WERE PROPERLY HANDLED, STORED, INSTALLED, AND MAINTAINED AND NOT SUBJECT TO CONTAMINATION, ABUSE, MISUSE, OR INAPPROPRIATE MODIFICATION OR REPAIR.

Application Considerations

SUITABILITY FOR USE

OMRON shall not be responsible for conformity with any standards, codes, or regulations that apply to the combination of products in the customer's application or use of the products.

Take all necessary steps to determine the suitability of the product for the systems, machines, and equipment with which it will be used.

Know and observe all prohibitions of use applicable to this product.

NEVER USE THE PRODUCTS FOR AN APPLICATION INVOLVING SERIOUS RISK TO LIFE OR PROPERTY WITHOUT ENSURING THAT THE SYSTEM AS A WHOLE HAS BEEN DESIGNED TO ADDRESS THE RISKS, AND THAT THE OMRON PRODUCTS ARE PROPERLY RATED AND INSTALLED FOR THE INTENDED USE WITHIN THE OVERALL EQUIPMENT OR SYSTEM.

Disclaimers

PERFORMANCE DATA

Performance data given in this catalog is provided as a guide for the user in determining suitability and does not constitute a warranty. It may represent the result of OMRON's test conditions, and the users must correlate it to actual application requirements. Actual performance is subject to the OMRON *Warranty and Limitations of Liability*.

CHANGE IN SPECIFICATIONS

Product specifications and accessories may be changed at any time based on improvements and other reasons. Consult with your OMRON representative at any time to confirm actual specifications of purchased product.

DIMENSIONS AND WEIGHTS

Dimensions and weights are nominal and are not to be used for manufacturing purposes, even when tolerances are shown.

ALL DIMENSIONS SHOWN ARE IN MILLIMETERS.

To convert millimeters into inches, multiply by 0.03937. To convert grams into ounces, multiply by 0.03527.

OMRON Corporation Industrial Automation Company

Tokyo, JAPAN

Contact: www.ia.omron.com

Regional Headquarters

OMRON EUROPE B.V.

Wegalaan 67-69-2132 JD Hoofddorp
The Netherlands
Tel: (31)2356-81-300/Fax: (31)2356-81-388

OMRON ELECTRONICS LLC

One Commerce Drive Schaumburg,
IL 60173-5302 U.S.A.
Tel: (1) 847-843-7900/Fax: (1) 847-843-7787

OMRON ASIA PACIFIC PTE. LTD.

No. 438A Alexandra Road # 05-05/08 (Lobby 2),
Alexandra Technopark,
Singapore 119967
Tel: (65) 6835-3011/Fax: (65) 6835-2711

OMRON (CHINA) CO., LTD.

Room 2211, Bank of China Tower,
200 Yin Cheng Zhong Road,
PuDong New Area, Shanghai, 200120, China
Tel: (86) 21-5037-2222/Fax: (86) 21-5037-2200

Authorized Distributor:

© OMRON Corporation 2009 All Rights Reserved.
In the interest of product improvement,
specifications are subject to change without notice.

CSM_5_1_1011
Cat. No. L116-E1-01

Printed in Japan
0709

Mouser Electronics

Authorized Distributor

Click to View Pricing, Inventory, Delivery & Lifecycle Information:

Omron:

[H5CZ-L8E AC100-240](#)

Компания «Океан Электроники» предлагает заключение долгосрочных отношений при поставках импортных электронных компонентов на взаимовыгодных условиях!

Наши преимущества:

- Поставка оригинальных импортных электронных компонентов напрямую с производств Америки, Европы и Азии, а так же с крупнейших складов мира;
- Широкая линейка поставок активных и пассивных импортных электронных компонентов (более 30 млн. наименований);
- Поставка сложных, дефицитных, либо снятых с производства позиций;
- Оперативные сроки поставки под заказ (от 5 рабочих дней);
- Экспресс доставка в любую точку России;
- Помощь Конструкторского Отдела и консультации квалифицированных инженеров;
- Техническая поддержка проекта, помощь в подборе аналогов, поставка прототипов;
- Поставка электронных компонентов под контролем ВП;
- Система менеджмента качества сертифицирована по Международному стандарту ISO 9001;
- При необходимости вся продукция военного и аэрокосмического назначения проходит испытания и сертификацию в лаборатории (по согласованию с заказчиком);
- Поставка специализированных компонентов военного и аэрокосмического уровня качества (Xilinx, Altera, Analog Devices, Intersil, Interpoint, Microsemi, Actel, Aeroflex, Peregrine, VPT, Syfer, Eurofarad, Texas Instruments, MS Kennedy, Miteq, Cobham, E2V, MA-COM, Hittite, Mini-Circuits, General Dynamics и др.);

Компания «Океан Электроники» является официальным дистрибьютором и эксклюзивным представителем в России одного из крупнейших производителей разъемов военного и аэрокосмического назначения «JONHON», а так же официальным дистрибьютором и эксклюзивным представителем в России производителя высокотехнологичных и надежных решений для передачи СВЧ сигналов «FORSTAR».



JONHON

«JONHON» (основан в 1970 г.)

Разъемы специального, военного и аэрокосмического назначения:

(Применяются в военной, авиационной, аэрокосмической, морской, железнодорожной, горно- и нефтедобывающей отраслях промышленности)

«FORSTAR» (основан в 1998 г.)

ВЧ соединители, коаксиальные кабели, кабельные сборки и микроволновые компоненты:

(Применяются в телекоммуникациях гражданского и специального назначения, в средствах связи, РЛС, а так же военной, авиационной и аэрокосмической отраслях промышленности).



Телефон: 8 (812) 309-75-97 (многоканальный)

Факс: 8 (812) 320-03-32

Электронная почта: ocean@oceanchips.ru

Web: <http://oceanchips.ru/>

Адрес: 198099, г. Санкт-Петербург, ул. Калинина, д. 2, корп. 4, лит. А