

## 1.5 A Buck-Boost DC/DC Converter with Synchronous Rectifier

NO. EA-353-150422

### OUTLINE

The RP602Z is a CMOS-based 1.5 A<sup>\*1</sup> buck-boost DC/DC converter with synchronous rectifier. Internally, a single converter consists of an oscillator, a reference voltage unit, an error amplifier, a switching control circuit, a mode control circuit, a soft-start circuit, an undervoltage lockout (UVLO) circuit, an overvoltage protection (OVP) circuit, an overcurrent protection circuit, a thermal shutdown circuit and switching transistors.

The RP602Z offers two power controlling methods, forced PWM control type and PWM/VFM auto switching control type. The power controlling method can be selected by inputting a signal to the MODE pin. In low output current, forced PWM control switches at fixed frequency rate in order to reduce noise. Likewise, in low output current, PWM/VFM auto switching control automatically switches from PWM mode to VFM mode in order to achieve high efficiency.

Output voltage is internally fixed type which allows output voltages that range from 2.7 to 4.2 V in 0.1 V step. The output voltage accuracy is as high as  $\pm 1.5\%$ . Protection circuits included in the RP602Z are overcurrent protection circuit and thermal shutdown circuit.

The RP602Z is offered in a 20-bump WLCSP package measuring 2.305 mm x 1.700 mm which can achieve the smallest possible footprint solution on board where area is limited.

<sup>\*1</sup> The output current can be affected by environmental conditions or external components. This is an approximate value.

### FEATURES

- Input Voltage Range (Absolute Maximum Ratings) .....2.3 V to 5.5 V (6.5 V)
- Output Voltage Range .....2.7 V to 4.2 V, Adjustable in 0.1 V steps
- Output Voltage Accuracy ..... $\pm 1.5\%$
- Line Regulation .....Typ. 0.5%, PWM Mode
- Load Regulation .....Typ. 0.1% at  $I_{OUT} = 0$  mA to 500 mA, PWM Mode
- Maximum Output Current .....Typ. 1.5 A,  $P_{VIN} = 3$  V,  $V_{OUT} = 3.3$  V
- Maximum Burst Current.....2.7 A,  $P_{VIN} = 3$  V,  $V_{OUT} = 3.3$  V, Duty = 10%,  $t = 2.0$  ms
- Overcurrent Limit Protection .....Typ. 4.2 A
- Oscillator Frequency.....Typ. 2.6 MHz
- Built-in Driver ON Resistance .....Typ. Pch. 80 m $\Omega$ , Nch. 80 m $\Omega$ ,  $V_{IN} = 3.6$  V
- Device Quiescent Current .....Typ. 27.5  $\mu$ A, VFM mode, non-switching
- UVLO Detector Threshold .....Typ. 2.0 V
- Soft-start Time .....Typ. 1.0 ms
- Thermal Shutdown Temperature .....Typ. 150 $^{\circ}$ C
- Inductor .....1.0  $\mu$ H
- Package .....20-bump WLCSP, 2.305 mm x 1.700 mm

### APPLICATIONS

- Power source for portable equipment such as laptops, PDAs, DSCs, cellular phones, and smartphones
- Power source for Li-ion battery-used equipment

# RP602Z

NO. EA-353-150422

## SELECTION GUIDE

### Selection Guide

Product Name	Package	Quantity per Reel	Pb Free	Halogen Free
RP602Zxxx\$-E2-F	WLCSP-20-P1	5,000 pcs	Yes	Yes

xxx: Specify the set output voltage ( $V_{SET}$ ) within the range of 2.7 V to 4.2 V in 0.1 V<sup>\*1</sup> steps

\$: Specify the combination of the auto-discharge option and the protection function option.

Symbol	Auto-discharge Function	Latch-type Protection	Reset-type Protection	Short-circuit Protection
A <sup>*2</sup>	Yes	Yes	No	Yes
B <sup>*2</sup>	No	Yes	No	Yes
C	Yes	No	Yes	Yes
D <sup>*2</sup>	No	No	Yes	Yes
E <sup>*2</sup>	Yes	No	No	Yes
F <sup>*2</sup>	No	No	No	Yes

\*1 0.05 V step is also available as a custom code.

\*2 The mass production is scheduled.

## BLOCK DIAGRAM

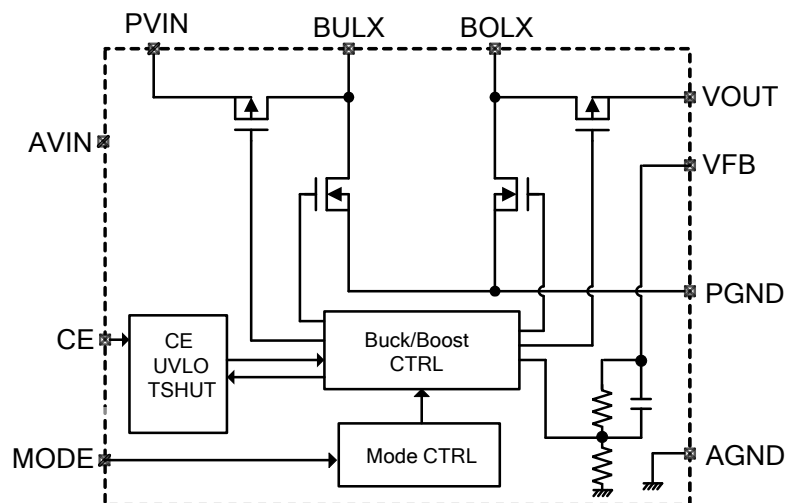

RP602Z Block Diagram

## PIN DESCRIPTION

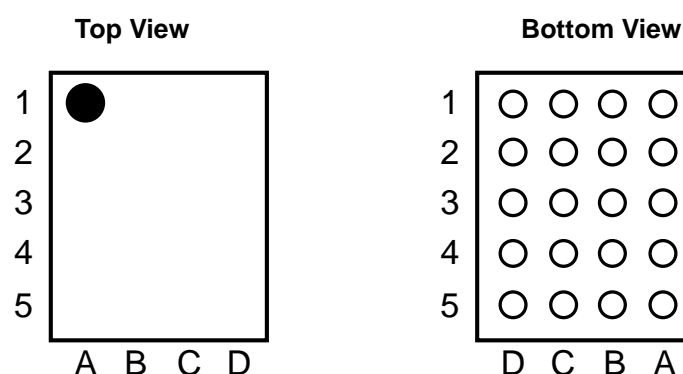

WLCSP-20 Pin Configuration

### Pin Description

Pin No	Symbol	Pin Description
A5, B5, C5 <sup>*1</sup>	VOUT	Output Voltage Pin
A4, B4, C4 <sup>*1</sup>	BOLX	Boost Switching Output Pin
A3, B3, C3 <sup>*2</sup>	PGND	Power GND Pin
A2, B2, C2 <sup>*1</sup>	BULX	Buck Switching Output Pin
A1, B1, C1 <sup>*1</sup>	PVIN	Power Input Voltage Pin
D1 <sup>*1</sup>	AVIN	Analog Power Input Voltage Pin
D2	CE	Chip Enable Pin, Active-high
D3	MODE	Mode Control Pin, Forced PWM Control: L, PWM/VFM Auto Switching Control: H
D4 <sup>*2</sup>	AGND	Analog GND Pin
D5	VFB	Output Voltage Feedback Pin

<sup>\*1</sup> The pin numbers sharing the same pin symbol must be connected together: A4, B4, and C4 of the BOLX pin, A2, B2, and C2 of the BULX pin, A5, B5, and C5 of the VOUT pin. D1 of the AVIN pin and A1, B1, and C1 of the PVIN pin must be connected together.

<sup>\*2</sup> D4 of the AGND pin and A3, B3, and C3 of the PGND pin must be connected to the ground.

### Pin Truth Table

CE Pin	MODE Pin <sup>*1</sup>	Operation
"L"	-	OFF
"H"	"H"	PWM/ VFM Auto Switching Control Mode
	"L"	Forced PWM Control Mode

<sup>\*1</sup> The logic to the MODE pin should not be changed while CE = "H".

---

**RP602Z**

---

NO. EA-353-150422

**ABSOLUTE MAXIMUM RATINGS****Absolute Maximum Ratings**

Symbol	Item	Rating	Unit
$V_{IN}$	AVIN/ PVIN Pin Input Voltage	-0.3 to 6.5	V
$V_{BULX}$	BULX Pin Voltage	-0.3 to $V_{IN} + 0.3$	V
$V_{BOLX}$	BOLX Pin Voltage	-0.3 to $V_{OUT} + 0.3$	V
$V_{CE}$	CE Pin Input Voltage	-0.3 to 6.5	V
$V_{MODE}$	MODE Pin Input Voltage	-0.3 to 6.5	V
$V_{OUT}$	VOUT Pin Voltage	-0.3 to 6.5	V
$V_{FB}$	VFB Pin Voltage	-0.3 to 6.5	V
$I_{LX}$	BULX/ BOLX Pin Output Current	4.2	A
$P_D$	Power Dissipation (Standard Land Pattern)*1	1400	mW
$T_a$	Operating Temperature Range	-40 to 85	°C
$T_{stg}$	Storage Temperature Range	-55 to 125	°C

\*1 Refer to *PACKAGE INFORMATION* for detailed information.

**ABSOLUTE MAXIMUM RATINGS**

Electronic and mechanical stress momentarily exceeded absolute maximum ratings may cause the permanent damages and may degrade the life time and safety for both device and system using the device in the field. The functional operation at or over these absolute maximum ratings are not assured.

**RECOMMENDED OPERATING CONDITIONS (ELECTRICAL CHARACTERISTICS)**

All of electronic equipment should be designed that the mounted semiconductor devices operate within the recommended operating conditions. The semiconductor devices cannot operate normally over the recommended operating conditions, even if when they are used over such conditions by momentary electronic noise or surge. And the semiconductor devices may receive serious damage when they continue to operate over the recommended operating conditions.

## ELECTRICAL CHARACTERISTICS

Open-loop Measurement GND = 0 V, unless otherwise noted.

### RP602ZxxxC Electrical Characteristics

(Ta = 25°C)

Symbol	Item	Conditions	Min.	Typ.	Max.	Unit
V <sub>IN</sub>	Operating Input Voltage		2.3		5.5	V
I <sub>DD</sub>	Quiescent Current	V <sub>IN</sub> = 5.5 V, V <sub>OUT</sub> = 4.2 V, V <sub>MODE</sub> = 5.5 V		27.5	60	μA
		V <sub>MODE</sub> = 0 V		1000	1400	
I <sub>standby</sub>	Standby Current	V <sub>IN</sub> = 5.5 V, V <sub>CE</sub> = 0 V		0.1	5.0	μA
V <sub>OUT</sub>	Output Voltage	V <sub>IN</sub> = 3.6 V	x0.985		x1.015	V
ΔV <sub>OUT</sub> / ΔTa	Output Voltage Temperature Coefficient	-40°C ≤ Ta ≤ 85°C		±50		ppm/°C
V <sub>OVP</sub>	OVP Detector Threshold	V <sub>IN</sub> = 3.6 V, Rising	4.5	5.0	5.5	V
	OVP Released Voltage	V <sub>IN</sub> = 3.6 V, Falling	4.3	4.8	5.3	V
f <sub>osc</sub>	Switching Frequency	V <sub>IN</sub> = 3.6 V	2.4	2.6	2.9	MHz
I <sub>LIMHS</sub>	BULX Current Limit*1	V <sub>IN</sub> = 3.6 V	3.7	4.2		A
R <sub>ON</sub>	High & Low Switch On Resistance	V <sub>IN</sub> = 3.6 V		80		mΩ
R <sub>DIS</sub>	On Resistance of Discharge Tr. (RP602ZxxxA/C/E)	V <sub>IN</sub> = 3.6 V, V <sub>CE</sub> = 0 V		80		Ω
I <sub>FBH</sub>	V <sub>FB</sub> "H" Input Current	V <sub>IN</sub> = 5.5 V, V <sub>CE</sub> = 0 V V <sub>FB</sub> = 5.5V			1	μA
I <sub>FBL</sub>	V <sub>FB</sub> "L" Input Current	V <sub>IN</sub> = 5.5 V, V <sub>CE</sub> = 0 V V <sub>FB</sub> = 0 V			1	μA
V <sub>H</sub>	CE, MODE & Input Voltage "H"	V <sub>IN</sub> = 5.5 V	1.0			V
V <sub>L</sub>	CE, MODE & Input Voltage "L"	V <sub>IN</sub> = 2.3 V			0.4	V
I <sub>H</sub>	CE, MODE & "H" Input Current	V <sub>IN</sub> = V <sub>CE</sub> = 5.5 V	-1	0	1	μA
I <sub>L</sub>	CE, MODE & "L" Input Current	V <sub>IN</sub> = 5.5 V, V <sub>CE</sub> = 0 V	-1	0	1	μA
V <sub>UVLO1</sub>	UVLO Detector Threshold	V <sub>IN</sub> = Falling	1.83	2.00		V
V <sub>UVLO2</sub>	UVLO Released Voltage	V <sub>IN</sub> = Rising		2.05	2.25	V
T <sub>TSD</sub>	Thermal Shutdown Threshold Temperature	T <sub>j</sub> , Rising		150		°C
T <sub>TSR</sub>		T <sub>j</sub> , Falling		110		°C
t <sub>start</sub>	Soft-start Time	V <sub>IN</sub> = 3.6 V		1		ms
t <sub>prot</sub>	Protection Delay Time (RP602ZxxxA/B/C/D)	V <sub>IN</sub> = 3.6 V		1.6		ms
t <sub>rst</sub>	Delay Time for Reset Protection (RP602ZxxxC/D)	V <sub>IN</sub> = 3.6 V		12		ms

All test items listed under *ELECTRICAL CHARACTERISTICS* are done under the pulse load condition (T<sub>j</sub> ≈ Ta = 25°C).

\*1 BULX Current Limit vary according to the switching duty ratio.

---

**RP602Z**

---

NO. EA-353-150422

**Product-specific Electrical Characteristics**

(Ta = 25°C)

Product Name	V <sub>OUT</sub> (V)		
	Min.	Typ.	Max.
RP602Z270x	2.660	2.700	2.740
RP602Z280x	2.758	2.800	2.842
RP602Z290x	2.857	2.900	2.943
RP602Z300x	2.955	3.000	3.045
RP602Z310x	3.054	3.100	3.146
RP602Z320x	3.152	3.200	3.248
RP602Z330x	3.251	3.300	3.349
RP602Z340x	3.349	3.400	3.451
RP602Z350x	3.448	3.500	3.552
RP602Z360x	3.546	3.600	3.654
RP602Z370x	3.645	3.700	3.755
RP602Z380x	3.743	3.800	3.857
RP602Z390x	3.842	3.900	3.958
RP602Z400x	3.940	4.000	4.060
RP602Z410x	4.039	4.100	4.161
RP602Z420x	4.137	4.200	4.263

## THEORY OF OPERATION

### Soft-start Time

#### Starting-up with CE Pin

The IC starts to operate when the CE pin voltage ( $V_{CE}$ ) exceeds the threshold voltage. The threshold voltage is preset between CE "H" input voltage ( $V_{CEH}$ ) and CE "L" input voltage ( $V_{CEL}$ ). After the start-up of the IC, soft-start circuit starts to operate. Then, after a certain period of time, the reference voltage ( $V_{REF}$ ) in the IC gradually increases up to the specified value. Soft-start time ( $t_{start}$ ) starts when soft-start circuit is activated, and ends when the reference voltage reaches the specified voltage. Soft start time is not always equal to the turn-on speed of the DC/DC converter. Note that the turn-on speed could be affected by the power supply capacity, the output current, the inductance value and the  $C_{OUT}$  value.

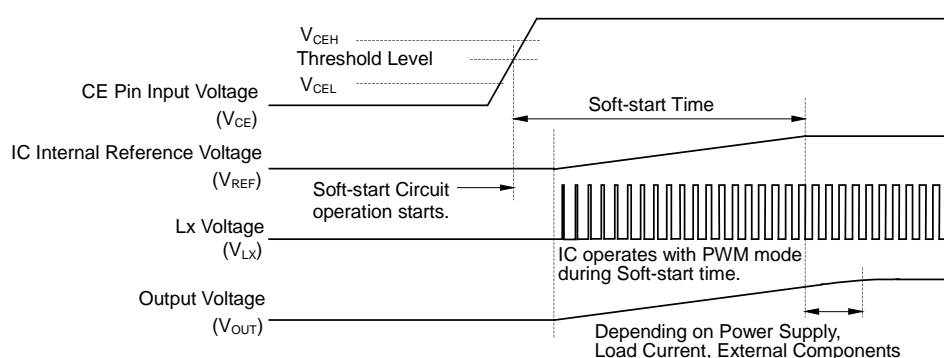

Timing Chart: Starting-up with CE Pin

#### Starting-up with Power Supply

After the power-on, when  $V_{IN}$  exceeds the UVLO released voltage ( $V_{UVLO2}$ ), the IC starts to operate. Then, soft-start circuit starts to operate and after a certain period of time,  $V_{REF}$  gradually increases up to the specified value. Soft-start time starts when soft-start circuit is activated, and ends when  $V_{REF}$  reaches the specified voltage. Note that the turn-on speed of  $V_{OUT}$  could be affected by the power supply capacity, the output current, the inductance value, the  $C_{OUT}$  value and the turn-on speed of  $V_{IN}$  determined by  $C_{IN}$ .

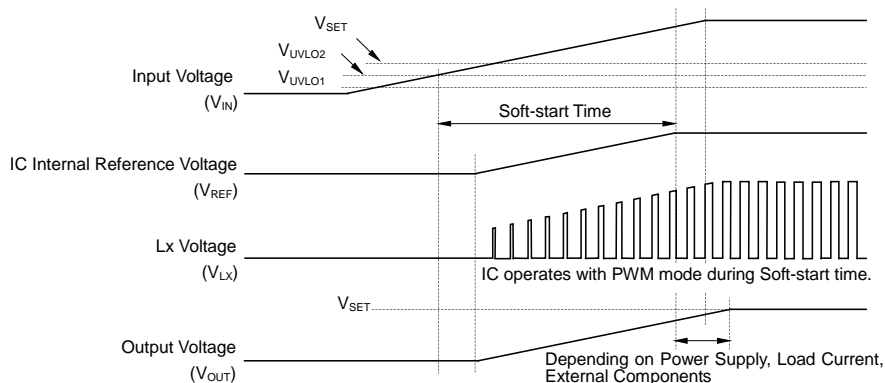

Timing Chart: Starting-up with Power Supply

---

## RP602Z

---

NO. EA-353-150422

### Undervoltage Lockout (UVLO) Circuit

If the  $V_{IN}$  becomes lower than the UVLO detector threshold ( $V_{UVLO1}$ ), the UVLO circuit starts to operate,  $V_{REF}$  stops, and P-channel and N-channel built-in switch transistors turn "OFF". As a result,  $V_{OUT}$  drops according to the  $C_{OUT}$  capacitance value and the load. To restart the operation,  $V_{IN}$  needs to be higher than  $V_{UVLO2}$ .

### Overvoltage Protection (OVP) Circuit

If the  $V_{OUT}$  becomes higher than the OVP detector threshold ( $V_{OVP}$ ), the OVP circuit starts to operate, P-channel and N-channel built-in switch transistors turn "OFF". As a result,  $V_{OUT}$  drops according to the  $C_{OUT}$  capacitance value and the load.

### Overcurrent Protection Circuit

Overcurrent protection circuit supervises the inductor peak current (the peak current flowing through Pch Tr (SW1) in each switching cycle, and if the current exceeds the BULX current limit ( $I_{LXLIM}$ ), it turns off Pch Tr (SW1).  $I_{LXLIM}$  of the RP602Z is set to Typ.4200 mA.

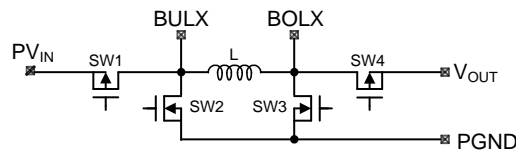

**Simplified Diagram of Output Switches**

### Short Protection Circuit

If the  $V_{OUT}$  becomes lower than a certain threshold, the BULX current limit is reduced.

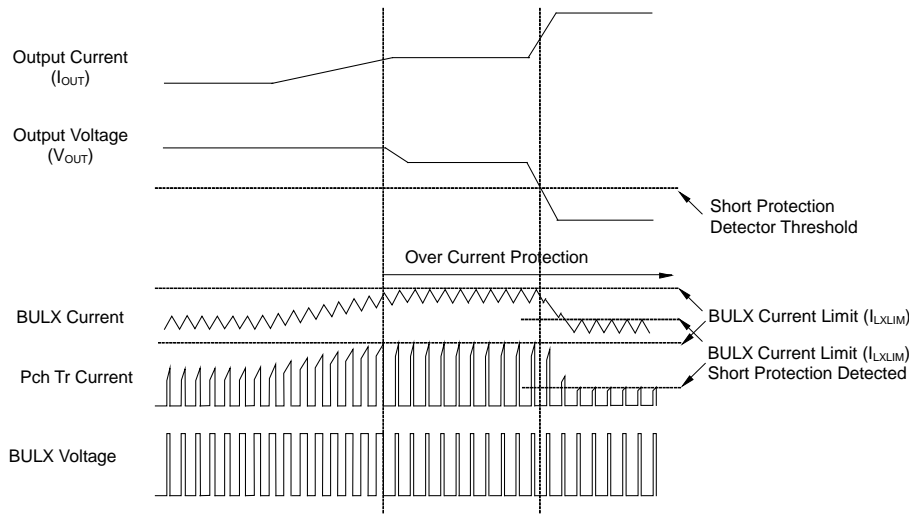

**Timing Chart: Overcurrent Protection Circuit & Short Protection Circuit**



**Latch Type Protection Circuit: RP602ZxxxA/B**

The latch type protection circuit latches the built-in drivers of SW1, SW2, SW3 and SW4 off to stop the operation of the device if the overcurrent state continues more than the protection delay time ( $t_{prot}$ ).

To release the latch-type protection, switch the CE pin from high to low to reset the device or make the input voltage ( $V_{IN}$ ) lower than the UVLO detector threshold ( $V_{UVLO1}$ ).

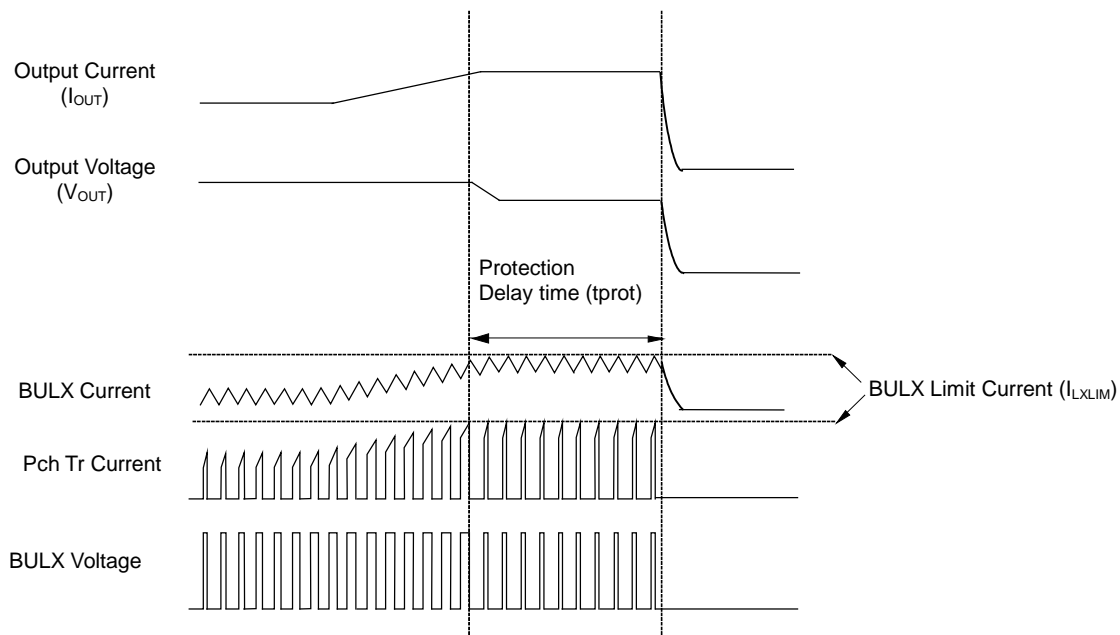

**Timing Chart: RP602ZxxxA/B Latch Protection Circuit**

---

**RP602Z**

---

NO. EA-353-150422

**Reset Type Protection Circuit: RP602ZxxxC/D**

When the overcurrent state continues more than the protection delay time ( $t_{prot}$ ), Reset type protection circuit operates and switching stops and the built-in drivers of SW1, SW2, SW3 and SW4 turn off and restarts after delay time for reset protection ( $t_{rst}$ ). When the overcurrent state is released, the operation is automatically released and returns to normal operation.

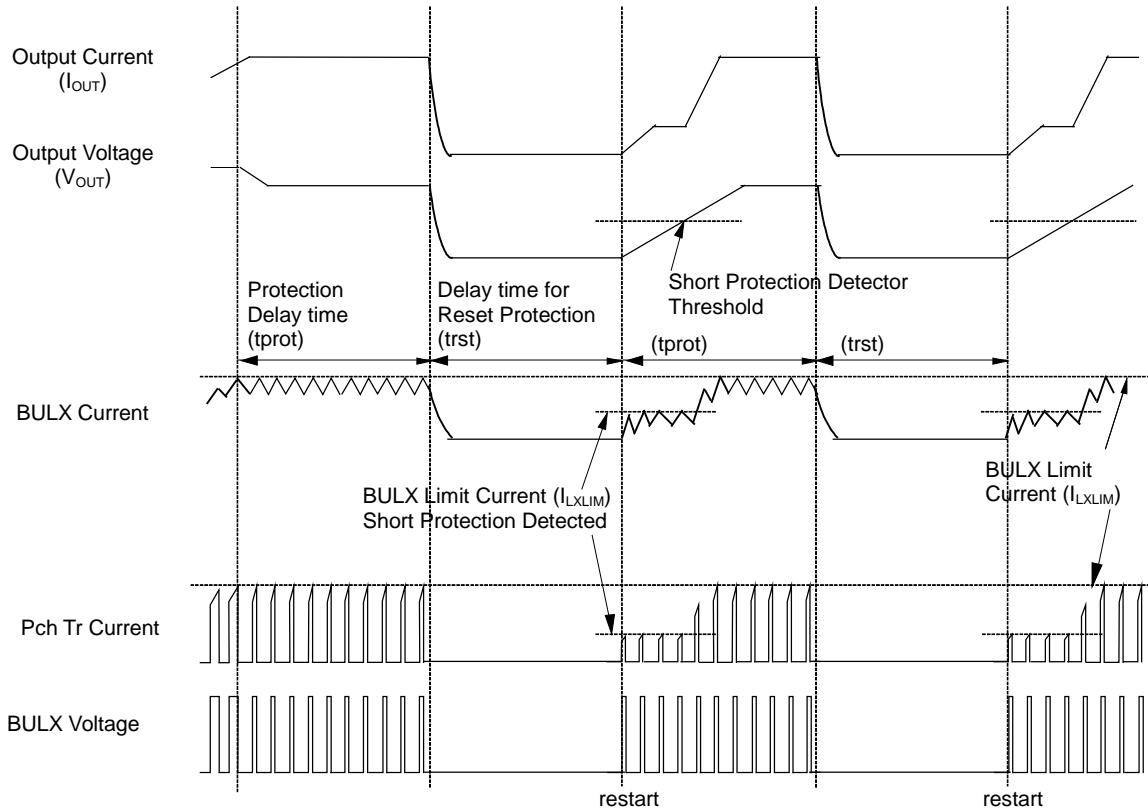
**Timing Chart: RP602ZxxxC/D Reset Protection Circuit**

## APPLICATION INFORMATION

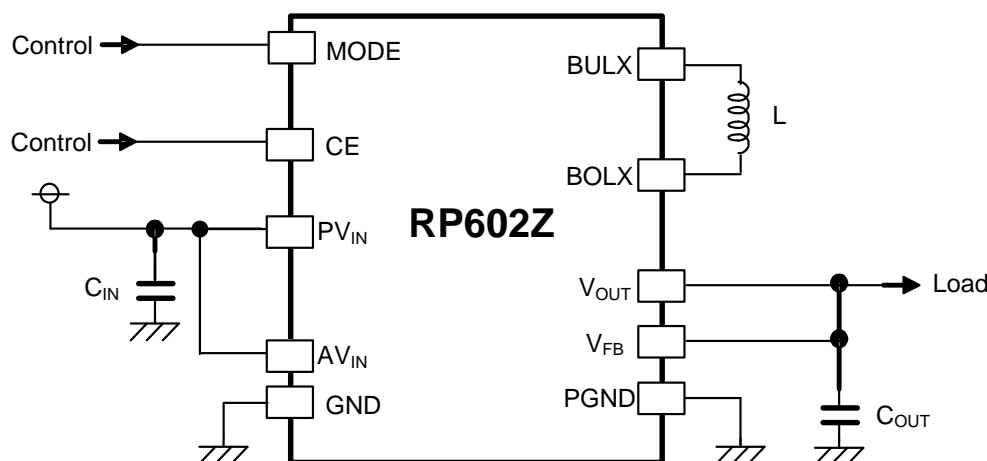

RP602ZxxxC/D Typical Application Circuit

### Recommended External Components

Symbol	Description
$C_{IN}^{*1}$	10 $\mu$ F, Ceramic, GRM188R60J106ME47, Murata
$C_{OUT}^{*2}$	22 $\mu$ F x 2, Ceramic, GRM188R60J226MEA0, Murata
L	1.0 $\mu$ H, Inductor, DFE201610P- 1R0M, TOKO 1.0 $\mu$ H, Inductor, XAL4020- 102ME, Coilcraft

\*1 Place  $C_{IN}$  as close as possible to the  $PV_{IN}$  pin.

\*2 Place  $C_{OUT}$  as close as possible to the  $V_{OUT}$  pin.

### Technical Notes on External Components Selection

- Use ceramic capacitors having a low equivalent series resistance (ESR).  $C_{OUT}$  should be paralleled with another  $C_{OUT}$ . When selecting the capacitors, consider the bias characteristics and input/ output voltage.
- When the built-in switches are turned off, the inductor may generate a spike-shaped high voltage. Use the high-breakdown voltage capacitor ( $C_{OUT}$ ) which output voltage is 1.5 times or more than the set output voltage.
- Use an inductor that has a low DC resistance, has an enough tolerable current and is less likely to cause magnetic saturation. If the inductance value is extremely small, the peak current of  $L_X$  may increase. When the peak current of  $L_X$  reaches to the  $L_X$  limit current ( $I_{LXLIM}$ ), overcurrent protection circuit starts to operate. When selecting the inductor, consider the maximum output current of  $L_X$  pin ( $I_{LXMAX}$ ). Refer to *Calculation Method of Maximum Output Current of  $L_X$  Pin ( $I_{LXMAX}$ ) in Continuous Mode* for details.

**Calculation Method of Maximum Output Current of Lx Pin ( $I_{LXMAX}$ ) in Continuous Mode**

The maximum output current of Lx pin ( $I_{LXMAX}$ ) can be calculated as follows, in the case of an ideal converter operating in steady conditions, using the components listed in *Recommended External Components of APPLICATION INFORMATION*.

Ripple Current P-P value is described as  $I_{RP}$ , ON resistance of Pch Tr. is described as  $R_{ONP}$ , ON resistance of Nch Tr. is described as  $R_{ONN}$ , and DC resistor of the inductor is described as  $R_L$ .

First, when Pch Tr. is "ON", the following equation is satisfied.

$$V_{IN} = V_{OUT} + (R_{ONP} + R_L) \times I_{OUT} + L \times I_{RP} / t_{on} \dots\dots\dots \text{Equation 1}$$

Second, when Pch Tr. is "OFF" (Nch Tr. is "ON"), the following equation is satisfied.

$$L \times I_{RP} / t_{off} = R_{ONN} \times I_{OUT} + V_{OUT} + R_L \times I_{OUT} \dots\dots\dots \text{Equation 2}$$

Put Equation 2 into Equation 1 to solve ON duty of Pch Tr. ( $D_{ON} = t_{on} / (t_{off} + t_{on})$ ):

$$D_{ON} = (V_{OUT} + R_{ONN} \times I_{OUT} + R_L \times I_{OUT}) / (V_{IN} + R_{ONN} \times I_{OUT} - R_{ONP} \times I_{OUT}) \dots\dots\dots \text{Equation 3}$$

Ripple Current is described as follows:

$$I_{RP} = (V_{IN} - V_{OUT} - R_{ONP} \times I_{OUT} - R_L \times I_{OUT}) \times D_{ON} / f_{osc} / L \dots\dots\dots \text{Equation 4}$$

Peak current that flows through L, and Lx Tr. is described as follows:

$$I_{LXmax} = I_{OUT} + I_{RP} / 2 \dots\dots\dots \text{Equation 5}$$

## TECHNICAL NOTES

The performance of a power source circuit using this device is highly dependent on a peripheral circuit. A peripheral component or the device mounted on PCB should not exceed a rated voltage, a rated current or a rated power. When designing a peripheral circuit, please be fully aware of the following points.

- Place the bypass capacitor ( $C_{INP}$ ) between the  $V_{INP}$  pin and the GND pin with shortest-distance wiring.
- Place the output capacitor ( $C_{OUT}$ ) between the  $V_{OUT}$  pin and the GND pin with shortest-distance wiring. Connect GND of  $C_{OUT}$  to the GND pin with shortest-distance wiring.
- Make the GND plane wide.
- Ensure the  $V_{INP}$  and GND lines are firmly connected. A large switching current flows through the  $V_{INP}$ , GND, inductor, BOLX, BULX and  $V_{OUT}$  lines. If their impedance is too high, noise pickup or unstable operation may result.
- Connect the BOLX pin and the inductor and the BULX pin with shortest-distance wiring.

# RP602Z

NO. EA-353-150422

## PACKAGE INFORMATION

### POWER DISSIPATION (WLCSP-20-P1)

Power Dissipation ( $P_D$ ) of the package is dependent on PCB material, layout, and environmental conditions. The following conditions are used in this measurement.

#### Measurement Conditions

JEDEC STD. 51-9 Test Land Pattern	
Environment	Mounting on Board (Wind Velocity = 0 m/s)
Board Material	Glass Cloth Epoxy Plastic (4-Layer)
Board Dimensions	101.5 mm x 114.5 mm x 1.6 mm
Copper Ratio	Top-side, Back-side: Approx.60% 2nd, 3rd Layer: Approx. 100%

#### Measurement Result

( $T_a = 25^\circ\text{C}$ ,  $T_{j\text{max}} = 125^\circ\text{C}$ )

JEDEC STD. 51-9 Test Land Pattern	
Power Dissipation	1400 mW
Thermal Resistance	$\theta_{ja} = (125 - 25^\circ\text{C}) / 1.4 \text{ W} = 71^\circ\text{C/W}$

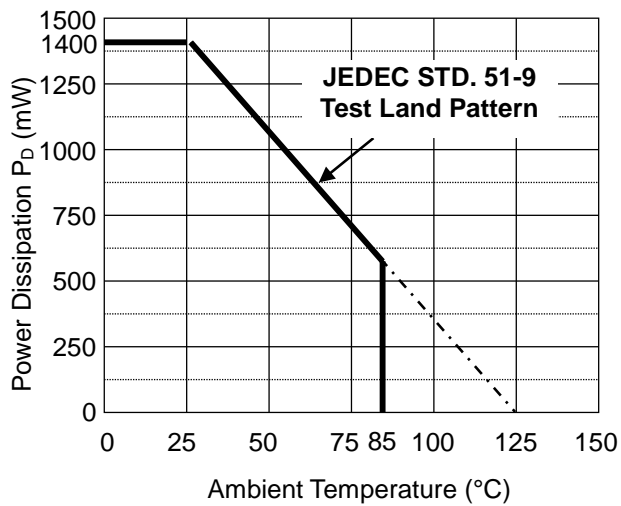

Ambient Temperature vs. Power Dissipation

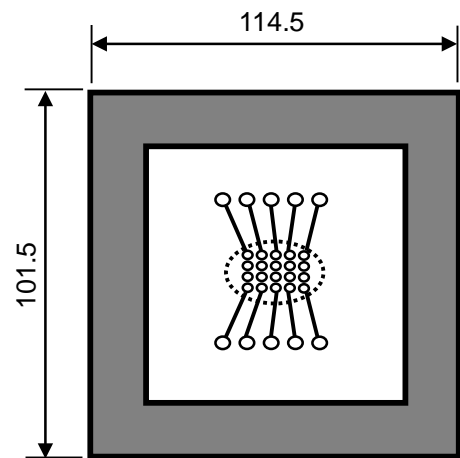

Standard Test Land Pattern

○ IC Mount Area (Unit: mm)

Measurement Board Pattern

PACKAGE DIMENSIONS (WLCSP-20-P1)

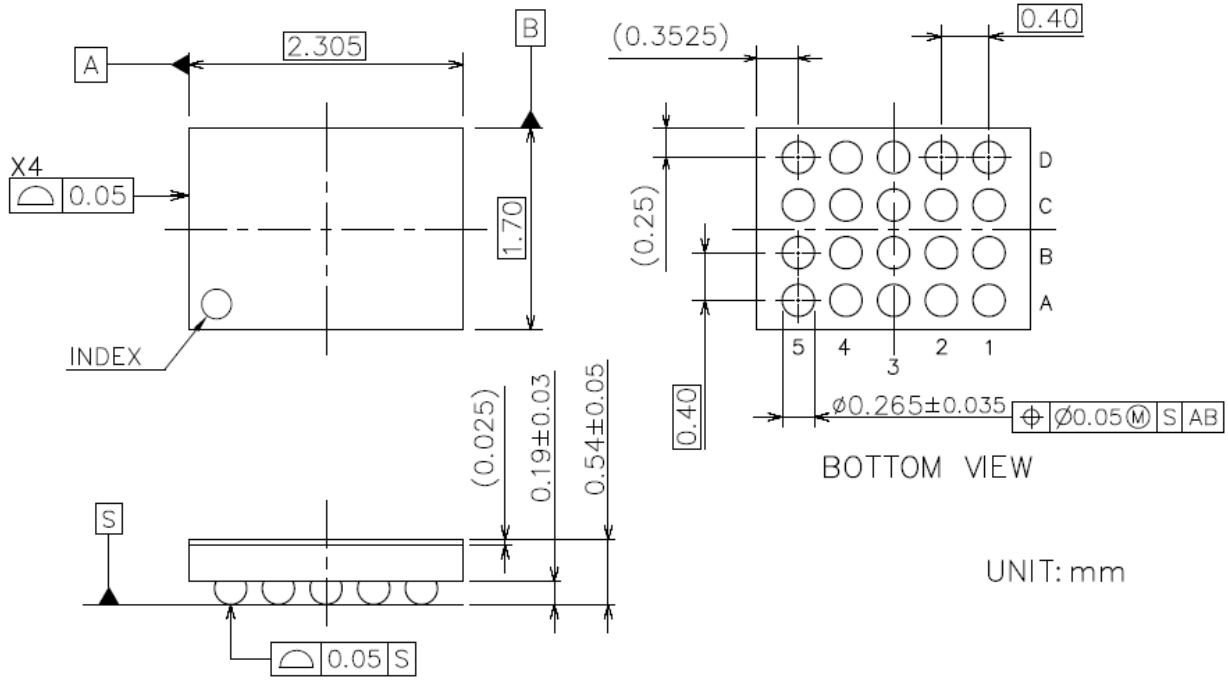

BOTTOM VIEW

UNIT: mm

WLCSP-20-P1 Package Dimensions

---

# RP602Z

---

NO. EA-353-150422

## TYPICAL CHARACTERISTICS

Note: Typical Characteristics are intended to be used as reference data; they are not guaranteed.

### 1) Input Voltage vs. Output Voltage

RP602Z330x, MODE = H

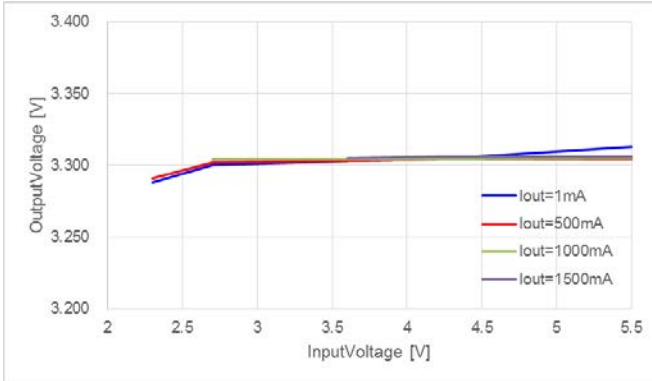

RP602Z330x, MODE = L

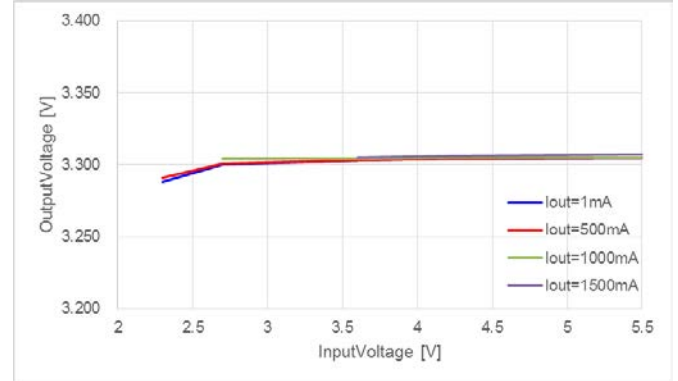

### 2) Output Current vs. Efficiency (for Different Input Voltages)

RP602Z330x, MODE = H

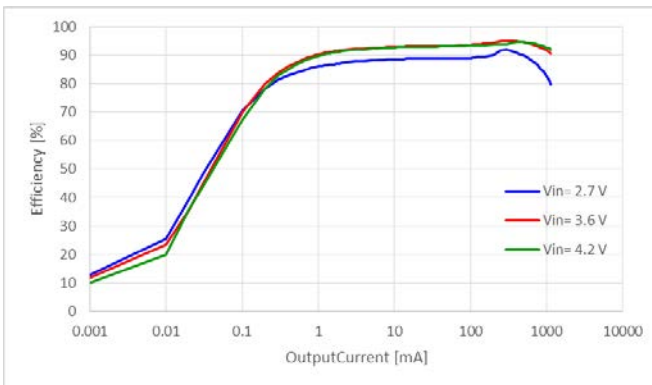

RP602Z330x, MODE = L

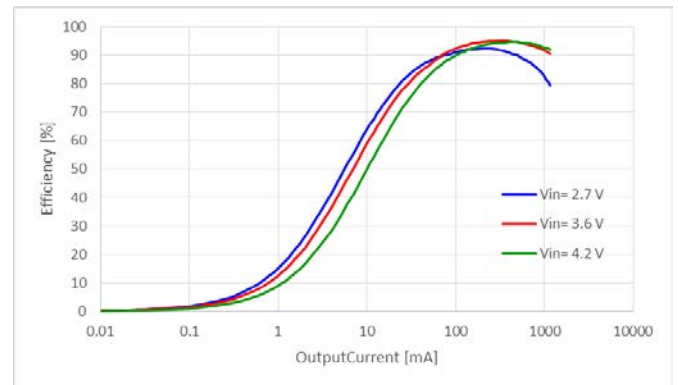

### 3) Output Current vs. Output Voltage

RP602Z330x, MODE = H

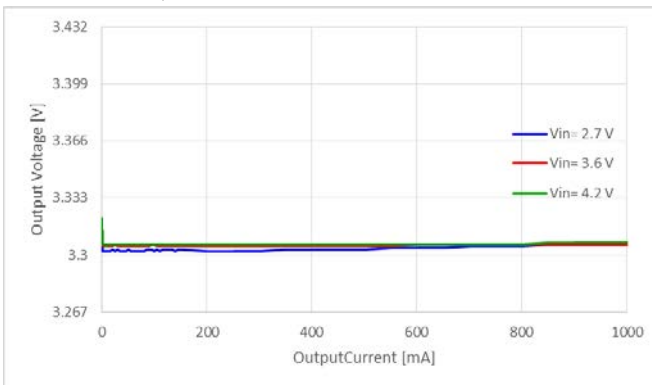

RP602Z330x, MODE = L

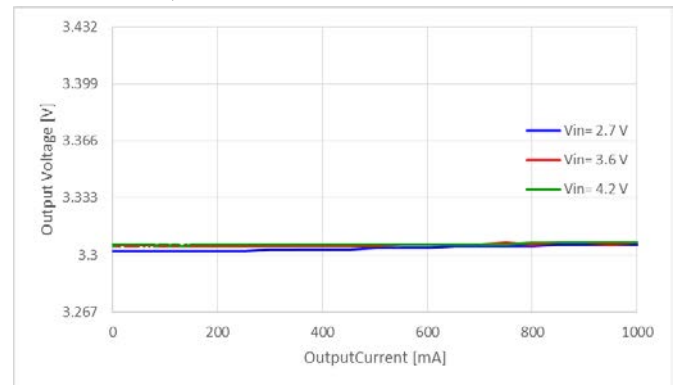



**4) Temperature vs. Output Voltage**  
**RP602Z330x**

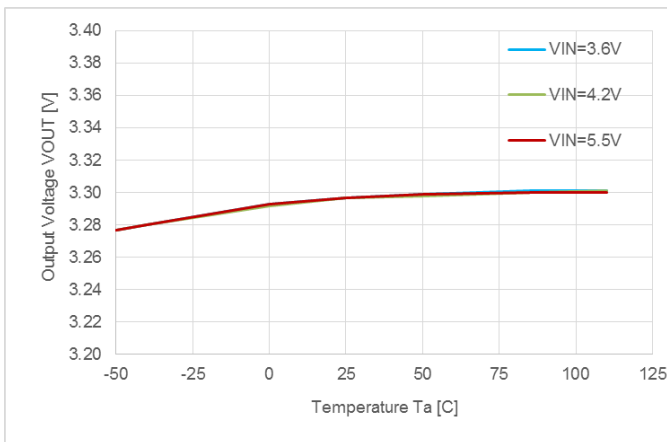

**5) Temperature vs. Standby Current**  
**RP602Z330x, VIN = 5.5 V**

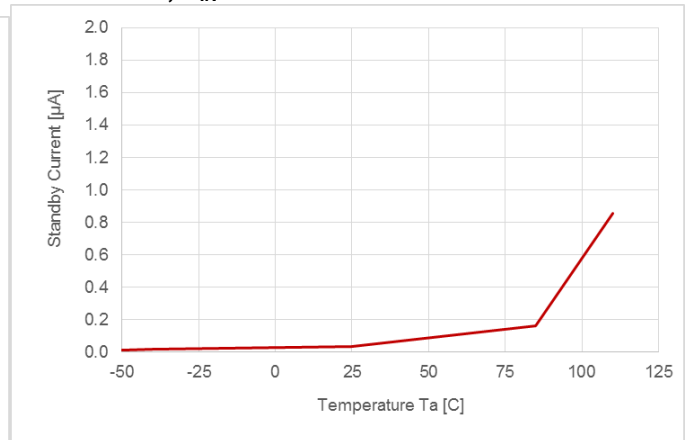

**6) Input Voltage vs. Output Current**  
**RP602Z330x, MODE = L**

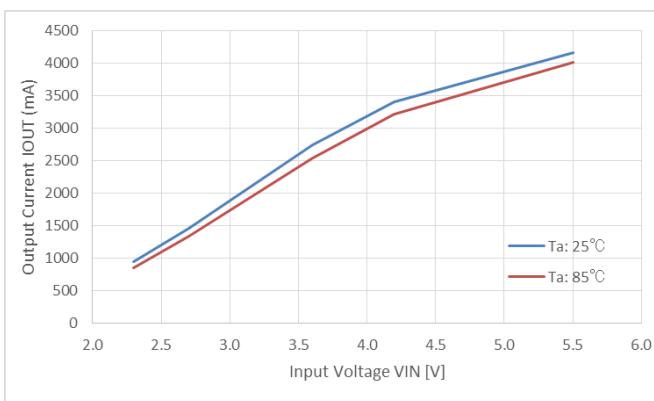

**7) Temperature vs. Soft-start Time**  
**RP602Z330x**

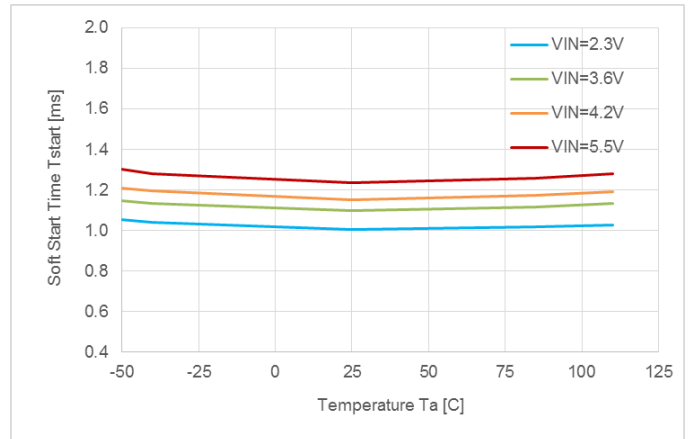

**8) CE Start-up Waveform**  
**RP602Z330x, VIN = 3.6 V, MODE = H**  
**IOUT = 0 mA**

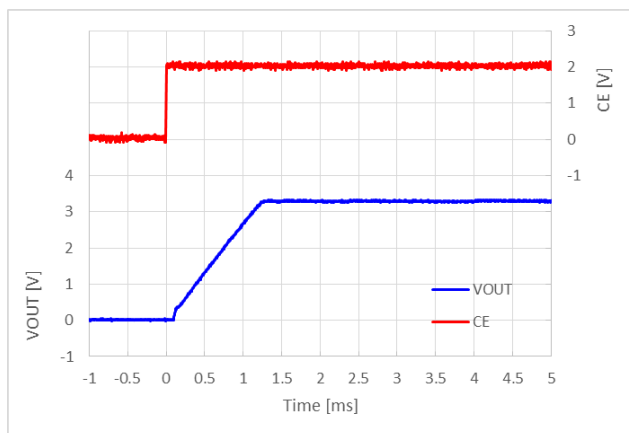

**RP602Z330x, VIN = 5.5 V, MODE = H**  
**IOUT = 0 mA**

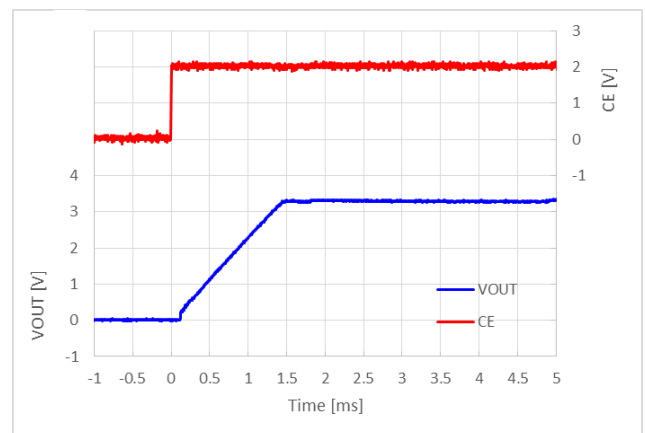

# RP602Z

NO. EA-353-150422

RP602Z330x,  $V_{IN} = 3.6\text{ V}$ , MODE = L  
 $I_{OUT} = 0\text{ mA}$

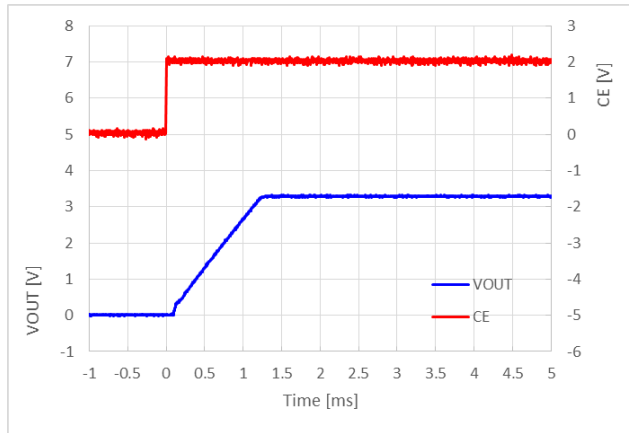

RP602Z330x,  $V_{IN} = 5.5\text{ V}$ , MODE = L  
 $I_{OUT} = 0\text{ mA}$

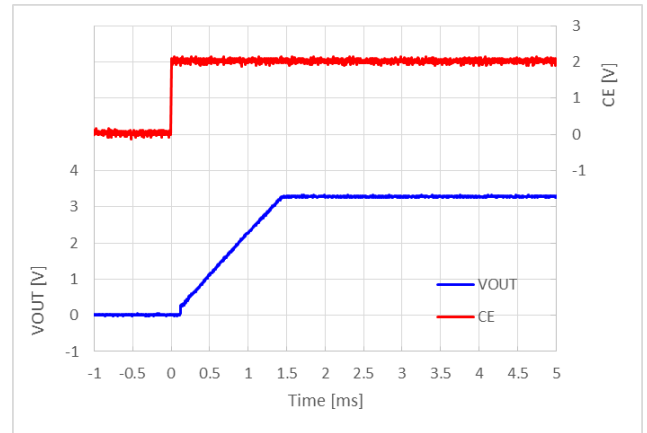

## 9) $V_{OUT}$ Waveform

RP602Z270x,  $V_{IN} = 3.6\text{ V}$ , MODE = H  
 $I_{OUT} = 10\text{ mA}$

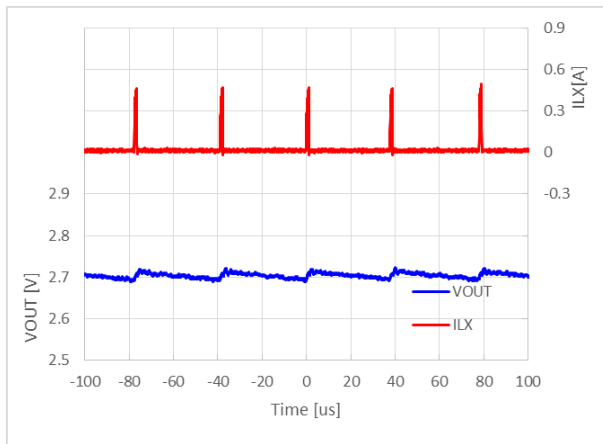

RP602Z270x,  $V_{IN} = 3.6\text{ V}$ , MODE = L  
 $I_{OUT} = 0\text{ mA}$

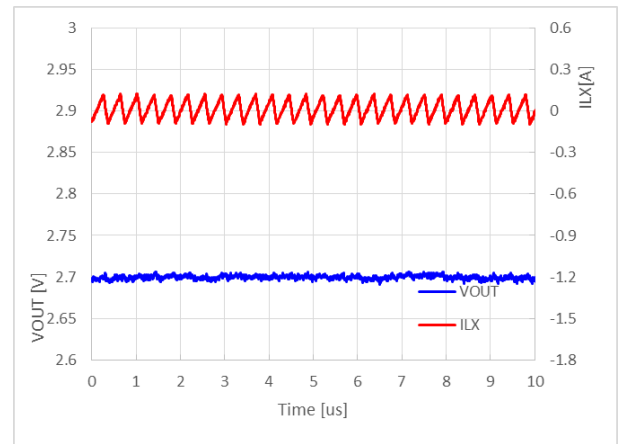

RP602Z330x,  $V_{IN} = 3.6\text{ V}$ , MODE = H  
 $I_{OUT} = 10\text{ mA}$

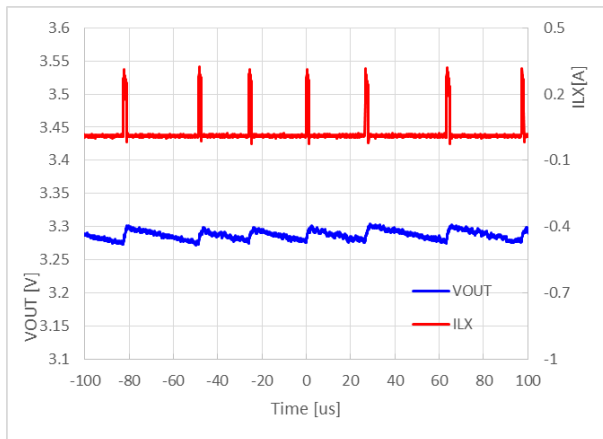

RP602Z330x,  $V_{IN} = 3.6\text{ V}$ , MODE = L  
 $I_{OUT} = 0\text{ mA}$

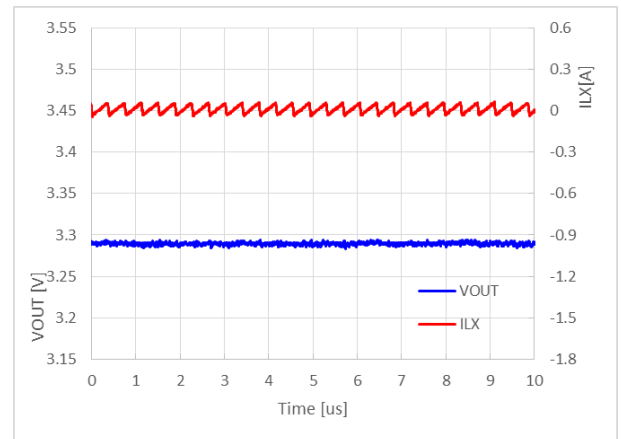

RP602Z420x,  $V_{IN} = 3.6\text{ V}$ , MODE = H  
 $I_{OUT} = 10\text{ mA}$

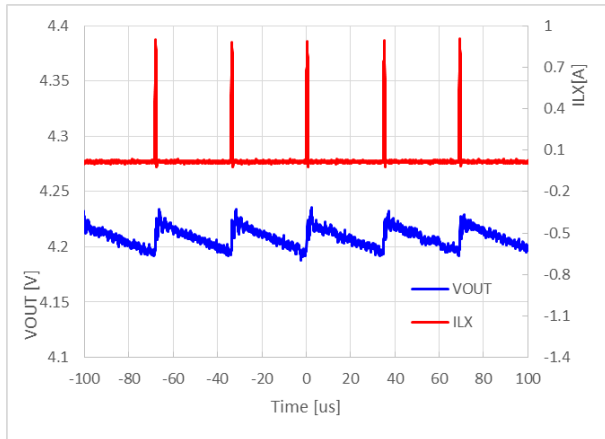

RP602Z420x,  $V_{IN} = 3.6\text{ V}$ , MODE = L  
 $I_{OUT} = 0\text{ mA}$

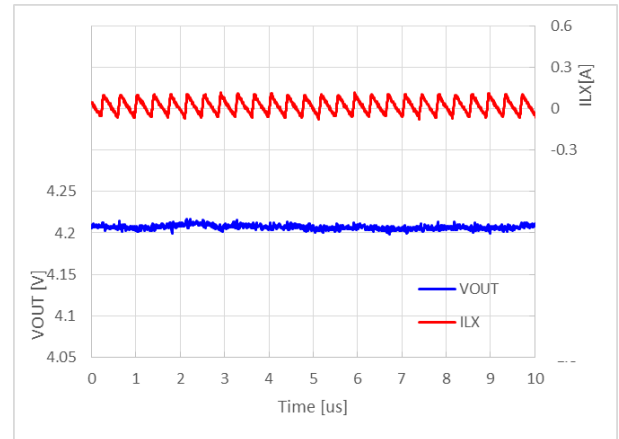

10) Load Transient Response Waveform  
 RP602Z330x,  $V_{IN} = 3.6\text{ V}$ , MODE = H

$I_{OUT} = 1\text{ mA} \leftrightarrow 500\text{ mA}$

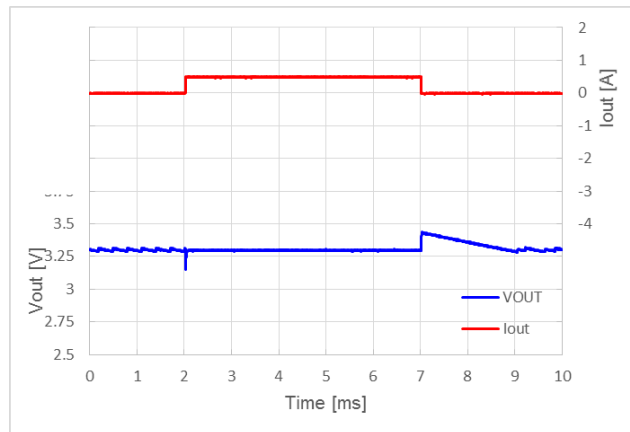

RP602Z330x,  $V_{IN} = 3.6\text{ V}$ , MODE = L

$I_{OUT} = 1\text{ mA} \leftrightarrow 500\text{ mA}$

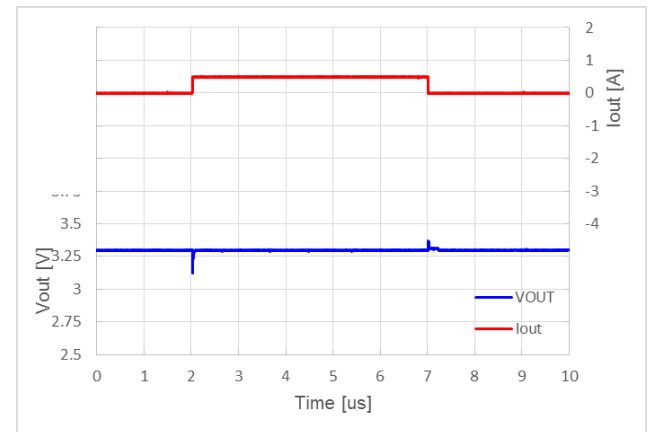

RP602Z330x,  $V_{IN} = 3.6\text{ V}$ , MODE = H

$I_{OUT} = 50\text{ mA} \leftrightarrow 900\text{ mA}$

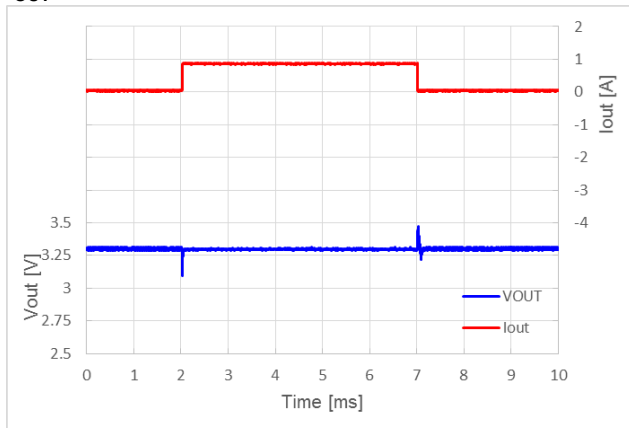

RP602Z330x,  $V_{IN} = 3.6\text{ V}$ , MODE = L

$I_{OUT} = 50\text{ mA} \leftrightarrow 900\text{ mA}$

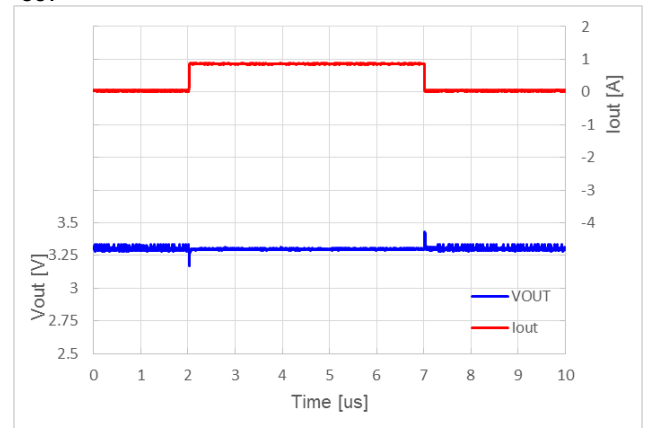

# RP602Z

NO. EA-353-150422

**RP602Z330x,  $V_{IN} = 3.6\text{ V}$ , MODE = H**  
 **$I_{OUT} = 1000\text{ mA} \leftrightarrow 1500\text{ mA}$**

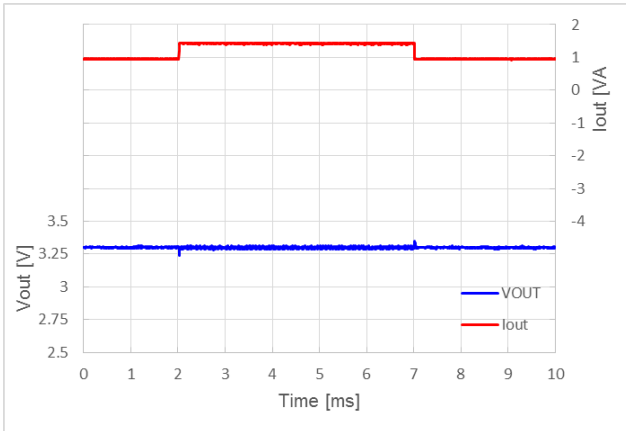

**RP602Z330x,  $V_{IN} = 3.6\text{ V}$ , MODE = L**  
 **$I_{OUT} = 1000\text{ mA} \leftrightarrow 1500\text{ mA}$**

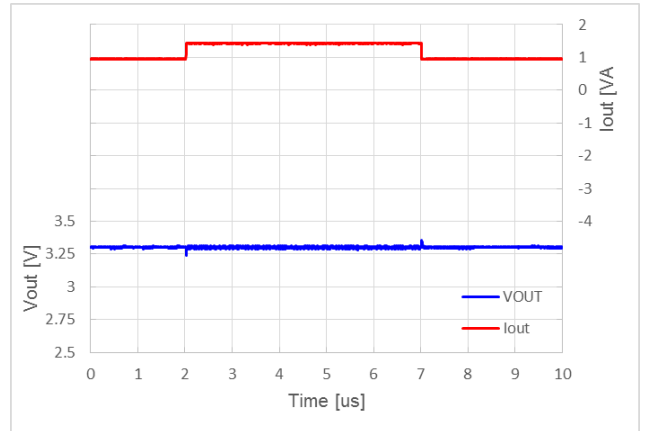

**11) CE Turn off Waveform**  
**RP602Z330x,  $V_{IN} = 3.6\text{ V}$ , MODE = H**  
 **$I_{OUT} = 0\text{ mA}$**

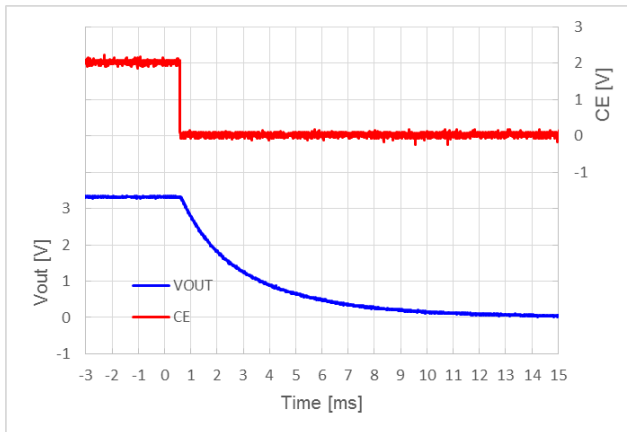

**RP602Z330x,  $V_{IN} = 3.6\text{ V}$ , MODE = L**  
 **$I_{OUT} = 0\text{ mA}$**

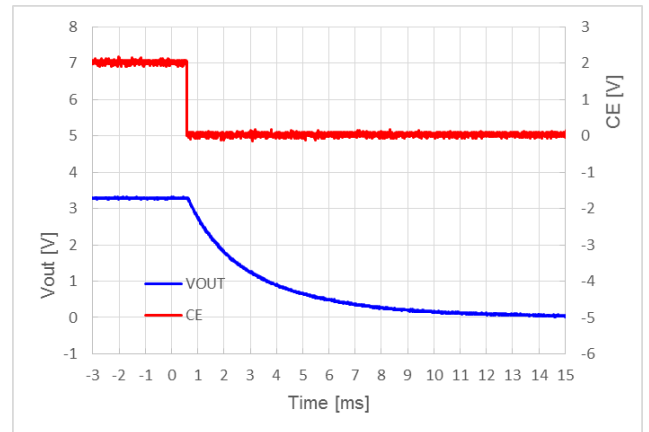

**12) Input Transient Response Waveform**  
**RP602Z330x, MODE = H**  
 **$I_{OUT} = 500\text{ mA}$ ,  $V_{IN} = 2.5\text{ V} \leftrightarrow 4.5\text{ V}$**

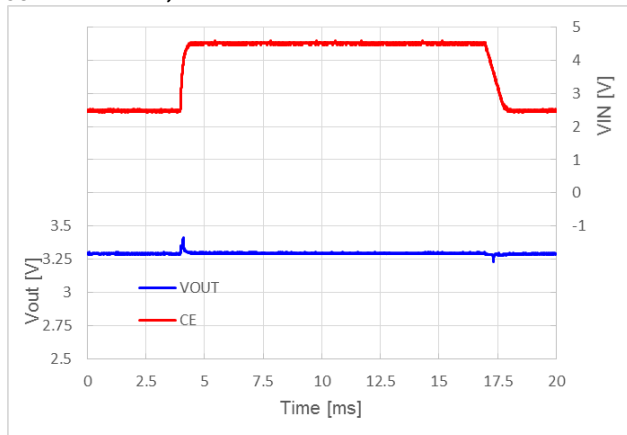

**RP602Z330x, MODE = L**  
 **$I_{OUT} = 500\text{ mA}$ ,  $V_{IN} = 2.5\text{ V} \leftrightarrow 4.5\text{ V}$**

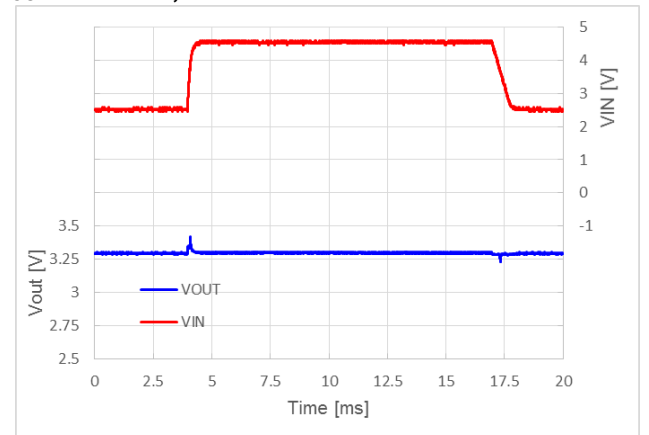



1. The products and the product specifications described in this document are subject to change or discontinuation of production without notice for reasons such as improvement. Therefore, before deciding to use the products, please refer to Ricoh sales representatives for the latest information thereon.
2. The materials in this document may not be copied or otherwise reproduced in whole or in part without prior written consent of Ricoh.
3. Please be sure to take any necessary formalities under relevant laws or regulations before exporting or otherwise taking out of your country the products or the technical information described herein.
4. The technical information described in this document shows typical characteristics of and example application circuits for the products. The release of such information is not to be construed as a warranty of or a grant of license under Ricoh's or any third party's intellectual property rights or any other rights.
5. The products listed in this document are intended and designed for use as general electronic components in standard applications (office equipment, telecommunication equipment, measuring instruments, consumer electronic products, amusement equipment etc.). Those customers intending to use a product in an application requiring extreme quality and reliability, for example, in a highly specific application where the failure or misoperation of the product could result in human injury or death (aircraft, spacevehicle, nuclear reactor control system, traffic control system, automotive and transportation equipment, combustion equipment, safety devices, life support system etc.) should first contact us.
6. We are making our continuous effort to improve the quality and reliability of our products, but semiconductor products are likely to fail with certain probability. In order to prevent any injury to persons or damages to property resulting from such failure, customers should be careful enough to incorporate safety measures in their design, such as redundancy feature, fire containment feature and fail-safe feature. We do not assume any liability or responsibility for any loss or damage arising from misuse or inappropriate use of the products.
7. Anti-radiation design is not implemented in the products described in this document.
8. Please contact Ricoh sales representatives should you have any questions or comments concerning the products or the technical information.



**Ricoh is committed to reducing the environmental loading materials in electrical devices with a view to contributing to the protection of human health and the environment.**

Ricoh has been providing RoHS compliant products since April 1, 2006 and Halogen-free products since April 1, 2012.

**RICOH** RICOH ELECTRONIC DEVICES CO., LTD.

<http://www.e-devices.ricoh.co.jp/en/>

#### Sales & Support Offices

##### **RICOH ELECTRONIC DEVICES CO., LTD.**

**Higashi-Shinagawa Office (International Sales)**  
3-32-3, Higashi-Shinagawa, Shinagawa-ku, Tokyo 140-8655, Japan  
Phone: +81-3-5479-2857 Fax: +81-3-5479-0502

##### **RICOH EUROPE (NETHERLANDS) B.V.**

**Semiconductor Support Centre**  
Prof. W.H. Keesomlaan 1, 1183 DJ Amstelveen, The Netherlands  
Phone: +31-20-5474-309

##### **RICOH ELECTRONIC DEVICES KOREA CO., LTD.**

3F, Haesung Bldg. 504, Teheran-ro, Gangnam-gu, Seoul, 135-725, Korea  
Phone: +82-2-2135-5700 Fax: +82-2-2051-5713

##### **RICOH ELECTRONIC DEVICES SHANGHAI CO., LTD.**

Room 403, No.2 Building, No.690 Bilbo Road, Pu Dong New District, Shanghai 201203,  
People's Republic of China  
Phone: +86-21-5027-3200 Fax: +86-21-5027-3299

##### **RICOH ELECTRONIC DEVICES CO., LTD.**

**Taipei office**  
Room 109, 10F-1, No.51, Hengyang Rd., Taipei City, Taiwan (R.O.C.)  
Phone: +886-2-2313-1621/1622 Fax: +886-2-2313-1623

# Mouser Electronics

Authorized Distributor

Click to View Pricing, Inventory, Delivery & Lifecycle Information:

[Ricoh Electronics:](#)

[RP602Z330C-E2-F](#)

Компания «Океан Электроники» предлагает заключение долгосрочных отношений при поставках импортных электронных компонентов на взаимовыгодных условиях!

Наши преимущества:

- Поставка оригинальных импортных электронных компонентов напрямую с производств Америки, Европы и Азии, а так же с крупнейших складов мира;
- Широкая линейка поставок активных и пассивных импортных электронных компонентов (более 30 млн. наименований);
- Поставка сложных, дефицитных, либо снятых с производства позиций;
- Оперативные сроки поставки под заказ (от 5 рабочих дней);
- Экспресс доставка в любую точку России;
- Помощь Конструкторского Отдела и консультации квалифицированных инженеров;
- Техническая поддержка проекта, помощь в подборе аналогов, поставка прототипов;
- Поставка электронных компонентов под контролем ВП;
- Система менеджмента качества сертифицирована по Международному стандарту ISO 9001;
- При необходимости вся продукция военного и аэрокосмического назначения проходит испытания и сертификацию в лаборатории (по согласованию с заказчиком);
- Поставка специализированных компонентов военного и аэрокосмического уровня качества (Xilinx, Altera, Analog Devices, Intersil, Interpoint, Microsemi, Actel, Aeroflex, Peregrine, VPT, Syfer, Eurofarad, Texas Instruments, MS Kennedy, Miteq, Cobham, E2V, MA-COM, Hittite, Mini-Circuits, General Dynamics и др.);

Компания «Океан Электроники» является официальным дистрибьютором и эксклюзивным представителем в России одного из крупнейших производителей разъемов военного и аэрокосмического назначения «JONHON», а так же официальным дистрибьютором и эксклюзивным представителем в России производителя высокотехнологичных и надежных решений для передачи СВЧ сигналов «FORSTAR».



## JONHON

«JONHON» (основан в 1970 г.)

Разъемы специального, военного и аэрокосмического назначения:

(Применяются в военной, авиационной, аэрокосмической, морской, железнодорожной, горно- и нефтедобывающей отраслях промышленности)

«FORSTAR» (основан в 1998 г.)

ВЧ соединители, коаксиальные кабели, кабельные сборки и микроволновые компоненты:

(Применяются в телекоммуникациях гражданского и специального назначения, в средствах связи, РЛС, а так же военной, авиационной и аэрокосмической отраслях промышленности).



Телефон: 8 (812) 309-75-97 (многоканальный)

Факс: 8 (812) 320-03-32

Электронная почта: [ocean@oceanchips.ru](mailto:ocean@oceanchips.ru)

Web: <http://oceanchips.ru/>

Адрес: 198099, г. Санкт-Петербург, ул. Калинина, д. 2, корп. 4, лит. А