

## FEATURES

- 2-axis light angle measurement**
- Linear response to the angle of incident light**
- Integrated visible light blocking optical filter**
- No optics required and no need for precise alignment**
- Low junction capacitance: 12.7 pF per channel at  $V_R = 0.2$  V**
- Low reverse dark current: 1.74 pA at  $V_R = 0.2$  V (all four channels connected in parallel)**
- 8-lead, 2 mm × 3 mm, 0.65 mm height, LFCSP**

## APPLICATIONS

- Gesture for user interface control in portable devices**
- Object location tracking**
- Industrial and automation monitoring**
- Angle sensing**
- Proximity sensing**
- Object distance measurement (triangulation)**

## GENERAL DESCRIPTION

The ADPD2140 is an optical sensor that measures the angle of incident infrared light. Light angles calculated from the ADPD2140 response are linear to  $\pm 5^\circ$  within an angular field of view of  $\pm 35^\circ$ .

The ADPD2140 has a radiant sensitive area of  $0.31 \text{ mm}^2$ . The low junction capacitance and low dark current of the ADPD2140 allows optimal integration with the [ADPD1080](#) photometric front end. The ADPD2140 can be used with a synchronous infrared light source such as a light emitting diode (LED) to

## FUNCTIONAL BLOCK DIAGRAM

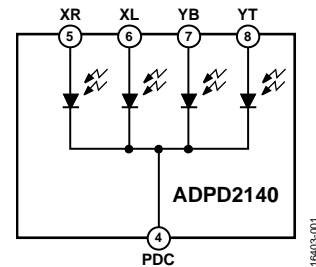

Figure 1.

detect user hand movements for gesture recognition. The ADPD2140 requires four photodiode channels. Therefore, use the [ADPD1080BCPZ](#) with the ADPD2140.

Packaged in a small, clear mold, 2 mm × 3 mm, 8-lead LFCSP, the ADPD2140 is specified over the  $-40^\circ\text{C}$  to  $+85^\circ\text{C}$  operating temperature range.

## TABLE OF CONTENTS

Features .....	1	Typical Performance Characteristics .....	6
Applications .....	1	Theory of Operation .....	7
Functional Block Diagram .....	1	Angular Response .....	7
General Description .....	1	Typical Connection Diagram .....	7
Revision History .....	2	Applications Information .....	8
Specifications .....	3	Gesture Recognition .....	8
Absolute Maximum Ratings .....	4	Object Triangulation .....	9
Thermal Resistance .....	4	Evaluation Board Schematic and Layout .....	10
Soldering Profile .....	4	Outline Dimensions .....	12
ESD Caution .....	4	Ordering Guide .....	12
Pin Configuration and Function Descriptions .....	5		

## REVISION HISTORY

8/2018—Revision 0: Initial Version

## SPECIFICATIONS

All specifications listed for the sum of all four photodiode channels, unless otherwise noted.

Table 1.

Parameter	Symbol	Test Conditions/Comments	Min	Typ	Max	Unit
<b>ELECTRICAL SPECIFICATIONS</b>						
Forward Voltage	$V_F$	Forward current ( $I_F$ ) = 10 mA		0.75		V
Reverse Dark Current	$I_D$	Reverse voltage ( $V_R$ ) = 0.2 V, $T_A = 20^\circ\text{C}$		1.74		pA
Junction Capacitance per Channel	$C_D$	$V_R = 0.2$ V, frequency = 100 kHz		12.7		pF
Rise Time	$t_r$	Load resistance ( $R_L$ ) = 50 $\Omega$ , $\lambda = 880$ nm		227		ns
Fall Time	$t_f$	$R_L = 50$ $\Omega$ , $\lambda = 880$ nm		228		ns
<b>OPTICAL SPECIFICATIONS</b>						
Radiant Sensitive Area	$A_D$			0.31		mm <sup>2</sup>
Angle of Half Sensitivity	$\varphi$			$\pm 60$		Degrees
Wavelength of Peak Sensitivity	$\lambda_P$			850		nm
Spectral Bandwidth	$\lambda_{10\%}$			800 to 1080		nm
Spectral Responsivity	$S_{880}$	$\lambda = 880$ nm		0.43		A/W
	$S_{940}$	$\lambda = 940$ nm		0.32		A/W
Angular Slope	M			0.00631		Ratio/ $^\circ$
Angular Zero Crossing Offset	Z			$\pm 5$		Degrees
Angular Field of View	FOV	Linearity within $\pm 5^\circ$		$\pm 35$		Degrees
<b>TEMPERATURE RANGE</b>						
Operating			-40		+85	$^\circ\text{C}$
Storage			-40		+125	$^\circ\text{C}$

## ABSOLUTE MAXIMUM RATINGS

Table 2.

Parameter	Rating
Voltage (Any Channel)	
Forward	1 V
Reverse	8 V
Power Dissipation	8 mW
Junction Temperature	110°C
Solder Reflow Temperature (<10 sec)	260°C
Electrostatic Discharge (ESD)	
Human Body Model (HBM)	2000 V
Charged Device Model (CDM)	1250 V

Stresses at or above those listed under Absolute Maximum Ratings may cause permanent damage to the product. This is a stress rating only; functional operation of the product at these or any other conditions above those indicated in the operational section of this specification is not implied. Operation beyond the maximum operating conditions for extended periods may affect product reliability.

### THERMAL RESISTANCE

Thermal performance is directly linked to printed circuit board (PCB) design and operating environment. Careful attention to PCB thermal design is required.

Table 3. Thermal Resistance<sup>1</sup>

Package Type	$\theta_{JA}$	$\theta_{JC}$	Unit
CP-8-17	52.45	11.55	°C/W

<sup>1</sup> Test condition: the thermal impedance simulated values are based on a JEDEC 252P thermal test board with four thermal vias. See JEDEC JESD-51.

### SOLDERING PROFILE

Figure 2 and Table 4 provide details about the recommended soldering profile.

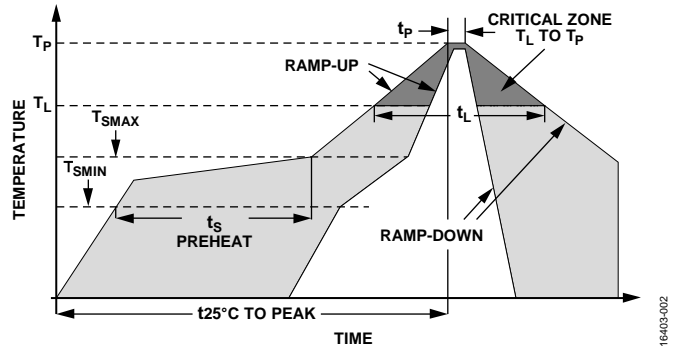

Figure 2. Recommended Soldering Profile

Table 4. Recommended Soldering Profile Limits<sup>1</sup>

Profile Feature	Condition (Pb Free)
Average Ramp Rate ( $T_L$ to $T_P$ )	2°C/sec maximum
Preheat	
Minimum Temperature ( $T_{SMIN}$ )	150°C
Maximum Temperature ( $T_{SMAX}$ )	200°C
Time ( $T_{SMIN}$ to $T_{SMAX}$ ) ( $t_s$ )	60 sec to 120 sec
$T_{SMAX}$ to $T_L$ Ramp-Up Rate	2°C/sec maximum
Liquidus Temperature ( $T_L$ )	217°C
Time Maintained Above $T_L$ ( $t_L$ )	60 sec to 150 sec
Peak Temperature ( $T_P$ )	260°C + (0°C/-5°C)
Time Within 5°C of Actual Peak Temperature ( $t_p$ )	20 sec to 30 sec
Ramp Down Rate	3°C/sec maximum
Time from 25°C to Peak Temperature ( $t_{25^\circ\text{C TO PEAK}}$ )	8 minutes maximum

<sup>1</sup> Based on JEDEC Standard J-STD-020D.1.

### ESD CAUTION



**ESD (electrostatic discharge) sensitive device.** Charged devices and circuit boards can discharge without detection. Although this product features patented or proprietary protection circuitry, damage may occur on devices subjected to high energy ESD. Therefore, proper ESD precautions should be taken to avoid performance degradation or loss of functionality.

# PIN CONFIGURATION AND FUNCTION DESCRIPTIONS

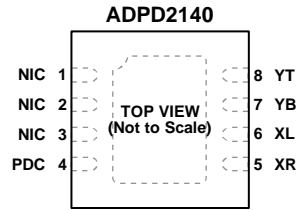

- NOTES**  
 1. NIC = NOT INTERNALLY CONNECTED.  
 2. EXPOSED PAD. ALWAYS CONNECT THE EXPOSED PAD TO PDC. DO NOT CONNECT THE EXPOSED PAD TO GROUND UNLESS PDC IS ALSO CONNECTED TO GROUND.

16r403-003

Figure 3. Pin Configuration

Table 5. Pin Function Descriptions

Pin No.	Mnemonic	Type	Description
1	NIC	Not internally connected	Not Internally Connected. Leave this pin floating.
2	NIC	Not internally connected	Not Internally Connected. Leave this pin floating.
3	NIC	Not internally connected	Not Internally Connected. Leave this pin floating.
4	PDC	Analog input	Photodiode Common Cathode (PDC).
5	XR	Analog output	Photodiode XR Anode.
6	XL	Analog output	Photodiode XL Anode.
7	YB	Analog output	Photodiode YB Anode.
8	YT	Analog output	Photodiode YT Anode.
	EPAD	Not applicable	Exposed Pad. Always connect the exposed pad to PDC. Do not connect the exposed pad to ground unless PDC is also connected to ground.

# TYPICAL PERFORMANCE CHARACTERISTICS

All performance characteristics listed for the sum of all four photodiode channels, unless otherwise noted.

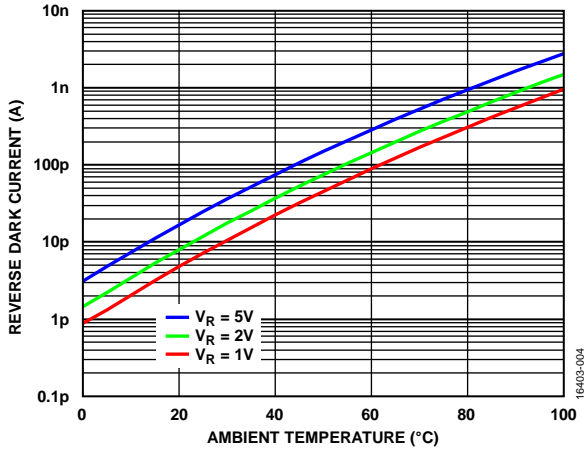

Figure 4. Reverse Dark Current vs. Ambient Temperature over Reverse Voltage ( $V_R$ )

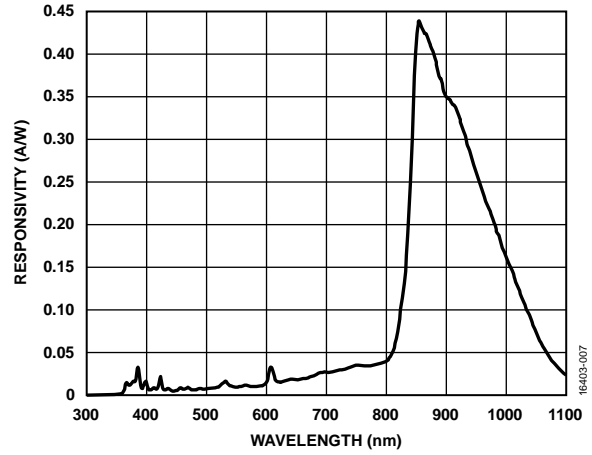

Figure 7. Responsivity vs. Wavelength (Angle = 0°)

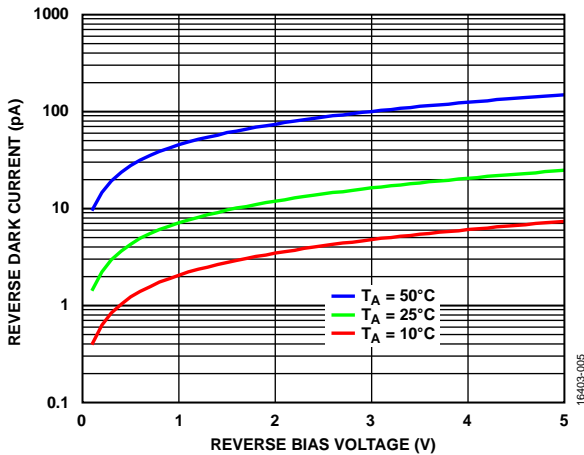

Figure 5. Reverse Dark Current vs. Reverse Bias Voltage over Temperature

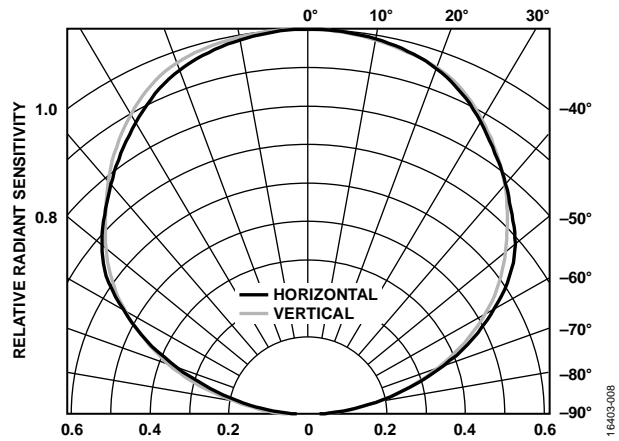

Figure 8. Relative Radiant Sensitivity vs. Angular Displacement

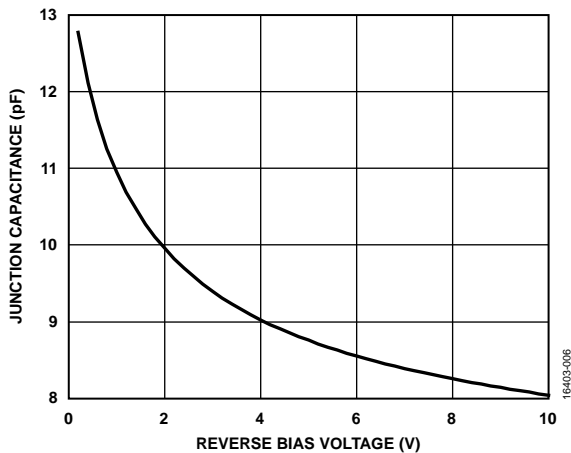

Figure 6. Junction Capacitance vs. Reverse Bias Voltage (per Channel)

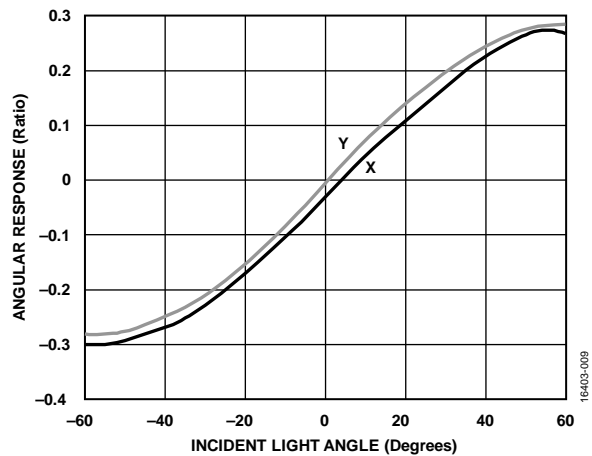

Figure 9. Angular Response vs. Incident Light Angle

# THEORY OF OPERATION

## ANGULAR RESPONSE

The ADPD2140 consists of arrays of silicon p-type, intrinsic, n-type (PIN) photodiodes that provide a linear measurement of incident infrared light angle. There are four separate channels on the ADPD2140, each corresponding to one photodiode.

The ADPD2140 enables a 2-axis light angle measurement, in both the x and y direction. To calculate angles in the x and y direction with respect to the sensor use the four photodiode channels ( $x_L$ ,  $x_R$ ,  $y_T$ , and  $y_B$ ) and the following equations:

$$x = (x_L - x_R) / (x_L + x_R) \tag{1}$$

$$y = (y_T - y_B) / (y_T + y_B) \tag{2}$$

The resulting quantities (x and y) are ratios related to angles through a constant term, M. Calculate angles in the horizontal and vertical direction by dividing x and y by the constant term, M (see Table 1). Angles measured by the ADPD2140 are linear to  $\pm 5^\circ$  within an angular field of view of  $\pm 35^\circ$  and zero crossing offset at  $\pm 5^\circ$ , as seen in Figure 9. The directionality when using Equation 1 and Equation 2 is shown in Figure 10, which indicates positive angles in the x and y directions.

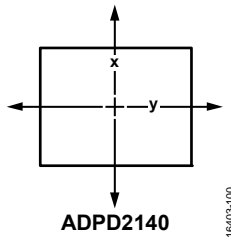

Figure 10. Directionality Response

The ADPD2140 is typically used in conjunction with a LED or laser emitter operating at a near infrared wavelength. The ADPD2140 provides light angle measurement without the need for an external lens. An external lens is neither required nor recommended for operation.

An integrated visible light blocking optical filter on the ADPD2140 provides built in rejection of unwanted visible ambient light signals, such as sunlight and indoor lighting. Figure 7 shows the combined responsivity of the ADPD2140 with the integrated optical filter.

The low junction capacitance and low dark current of the ADPD2140 allows optimal integration with the ADPD1080 photometric front end. This complete solution offers additional ambient light rejection, low power operation, and analog-to-digital conversion of the ADPD2140 analog signals.

## TYPICAL CONNECTION DIAGRAM

Figure 11 shows the ADPD2140 connections with the ADPD1080 photometric front end. With up to eight photodiode input channels, the ADPD1080 is a preferred choice for the analog front end for interfacing with the ADPD2140. In this configuration, the ADPD2140 and ADPD1080 solution can operate using synchronous LED pulses to detect the angle of light reflected from objects or used in ambient measurement mode to provide a measure of the incident angle of an ambient or other unsynchronized light source. For reference, the optimal choice of reverse bias for typical operation with the ADPD2140 is 0.2 V.

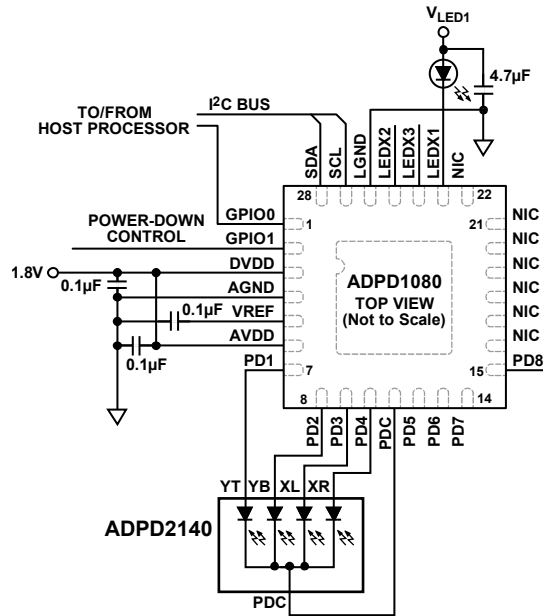

Figure 11. Typical Connection Diagram for the ADPD2140 and the ADPD1080

## APPLICATIONS INFORMATION

### GESTURE RECOGNITION

The unique angular response of the ADPD2140 coupled with the high performance ambient light rejection of the [ADPD1080](#) enables a robust and effective implementation of gesture recognition. The following algorithm demonstrates recognition of up, down, left, right, and click hand gestures based on data from the four channels of the ADPD2140:

1. Prior to operation of the ADPD2140 and the [ADPD1080](#) for gesture recognition, calibrate the [ADPD1080](#) clocks. See the [ADPD1080](#) data sheet for more information on how to calibrate the 32 kHz and 32 MHz clocks.
2. Set the [ADPD1080](#) mode of operation to sample mode by writing 0x2 to Register 0x10, Bits [1:0].
3. Collect the data measured by the device. See the [ADPD1080](#) data sheet for instructions on how to read data from registers using the first in, first out (FIFO) and interrupts. Data is available directly from data registers or from the 128-byte FIFO in Register 0x60, Bits [15:0].
4. The data in the four output channels of the [ADPD1080](#) calculates the angle of incident light. After the  $x_L$ ,  $x_R$ ,  $y_T$ , and  $y_B$  data are collected, calculate the angles and intensity with the following equations:
  - Horizontal angle:  $x = (x_L - x_R)/(x_L + x_R)$
  - Vertical angle:  $y = (y_T - y_B)/(y_T + y_B)$
  - Intensity:  $L = x_L + x_R + y_T + y_B$
5. Prior to gesture event detection, offsets of the [ADPD1080](#) must be digitally subtracted from each channel. These offsets are not due to photodiode dark current and are set by the [ADPD1080](#) on-chip analog-to-digital converter (ADC). Register 0x18, Register 0x19, Register 0x1A, and Register 0x1B contain the ADC offsets for Timeslot A, while Register 0x1A, Register 0x1B, Register 0x1E, and Register 0x1F contain the ADC offsets for Timeslot B. The nominal value for all offsets is 0x2000. To modify these offsets, measure the 16-bit output of each channel, in ADC codes, and add it to the existing 16-bit number in the ADC offset register, SLOTx\_CHx\_OFFSET (nominally 0x2000). Then, write to the ADC offset register with this result. When the offsets are correctly subtracted, the intensity reading  $L$  is close to zero codes with no objects in the sensor field of view.
6. The start of a gesture event can be defined as occurring when intensity data crosses a preset threshold. Nominally, this threshold must be set to 1000 codes. However, the threshold can be adjusted to suit the application.
7. The end of a gesture event can then be defined as the number of samples after which the intensity drops back below the preset threshold, past a certain minimum number of samples (nominally five samples).

8. Use the start and stop points of the gesture event to determine whether the gesture was up, right, left, down, or a click. For more detail on this process, see the following pseudocode:

```

event = False
intensityThreshold = 1000 (should be
adjustable by the user)
clickThreshold = 0.07 (should be adjustable
by the user)

if event = True:
    i += 1
    if i >= 5 and L < intensityThreshold:
        event = False
        gestureStopX = x
gestureStopY = y
m = (gestureStartY -
gestureStopY)/(gestureStartX - gestureStopX
+ 1e-6)
d = sqrt((gestureStartX - gestureStopX)^2 +
(gestureStartY - gestureStopY)^2)
if d < clickThreshold:
    gesture = 'CLICK'
else:
    if abs(m) > 1:
        if gestureStartY >
gestureStopY:
            gesture = 'UP'
        else:
            gesture = 'DOWN'
    elif abs(m) < 1:
        if gestureStartX >
gestureStopX:
            gesture = 'LEFT'
        else:
            gesture = 'RIGHT'
    else:
        if L > intensityThreshold:
            i = 0
            event = True
            gestureStartX = x
gestureStartY = y
  
```



## OBJECT TRIANGULATION

While a single ADPD2140 allows for measurement of the x and y coordinates of an object or light source, two ADPD2140 placed at a distance apart can calculate the z distance using triangulation. The superscripted A and B refer to ADPD2140 sensors that are measured in Timeslot A and Timeslot B of the ADPD2140. Calculate the triangulation distance z as follows:

If  $\text{sign}(y^A) = \text{sign}(y^B)$ ,

$$z = \frac{C}{\sqrt{(y^A - y^B)^2}}$$

Or, if  $\text{sign}(y^A) \neq \text{sign}(y^B)$ ,

$$z = \frac{C}{\sqrt{(y^A + y^B)^2}}$$

C is an empirically determined proportionality constant that depends on the baseline distance between the two angle diodes, which converts the x and y measurements to angles, in radians. For reference, the baseline distance, c, between both angle diodes is equal to 1" on the [EVAL-ADPD2140Z](#) evaluation board. This quantity sets the units of the final distance measurement output.

Figure 12 shows the operation of a typical triangulation measurement using the ADPD2140.

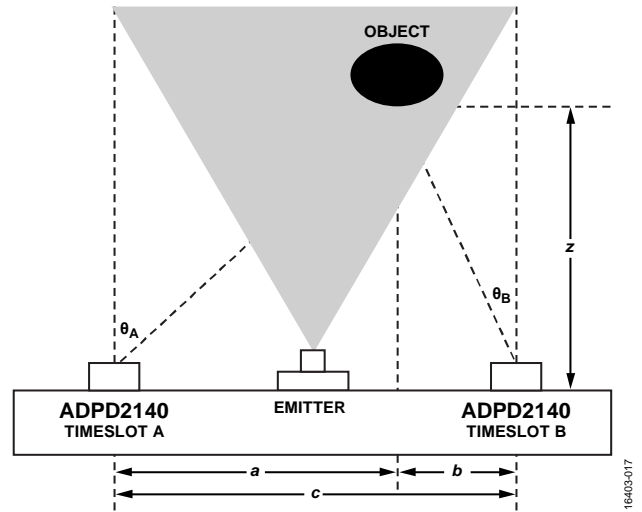

Figure 12. Triangulation Distance Measurement with the ADPD2140

16403-017

EVALUATION BOARD SCHEMATIC AND LAYOUT

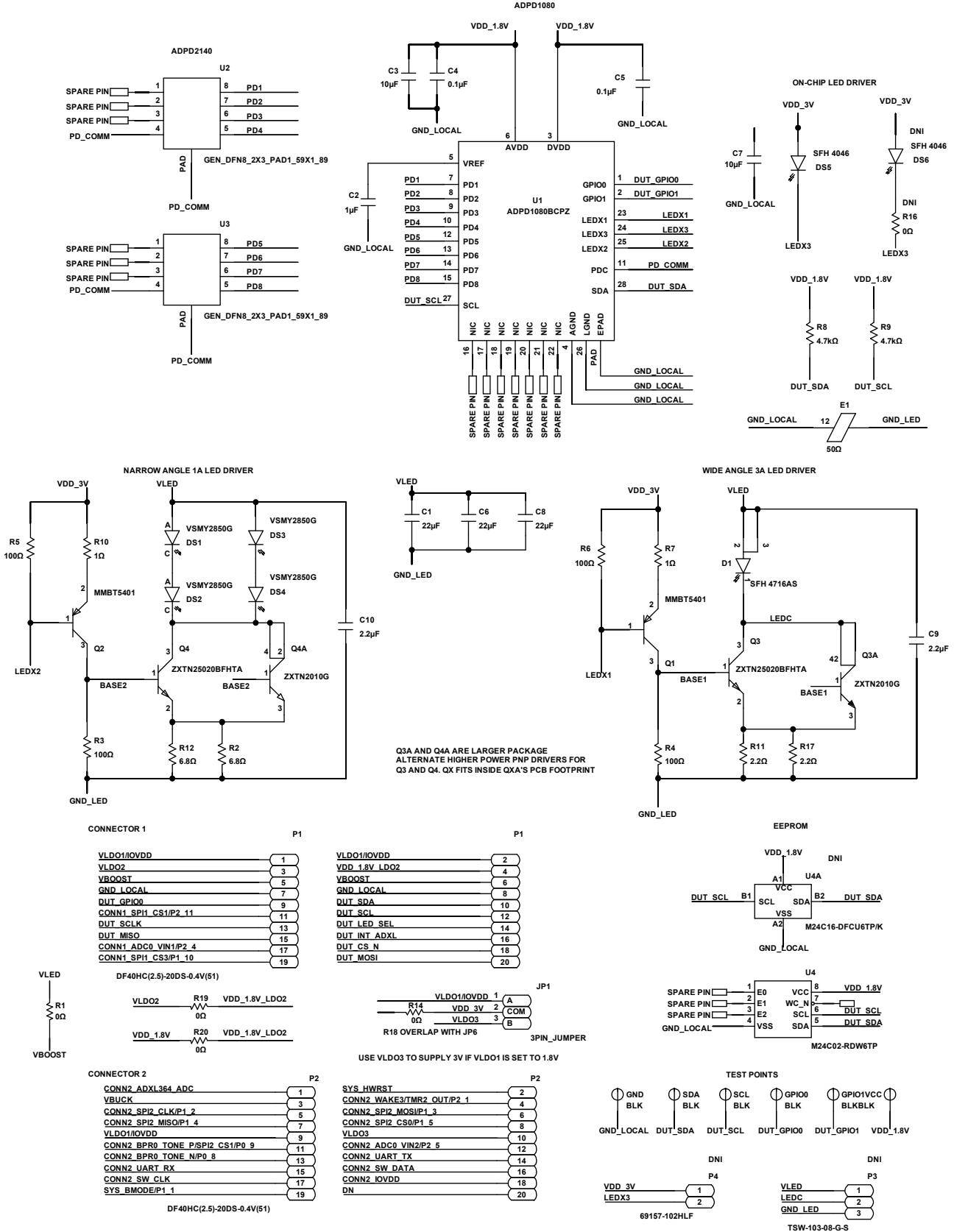

Figure 13. EVAL-ADPD2140Z Evaluation Board Schematic

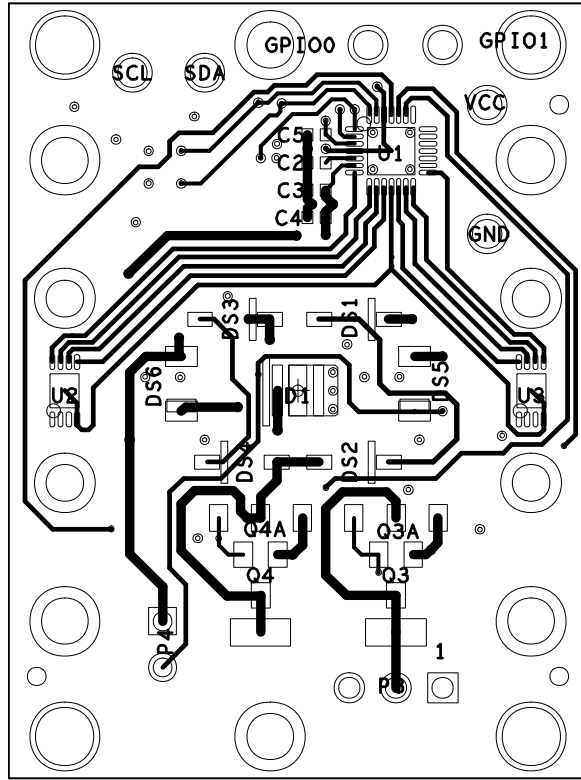

Figure 14. EVAL-ADPD2140Z Evaluation Board Layout

OUTLINE DIMENSIONS

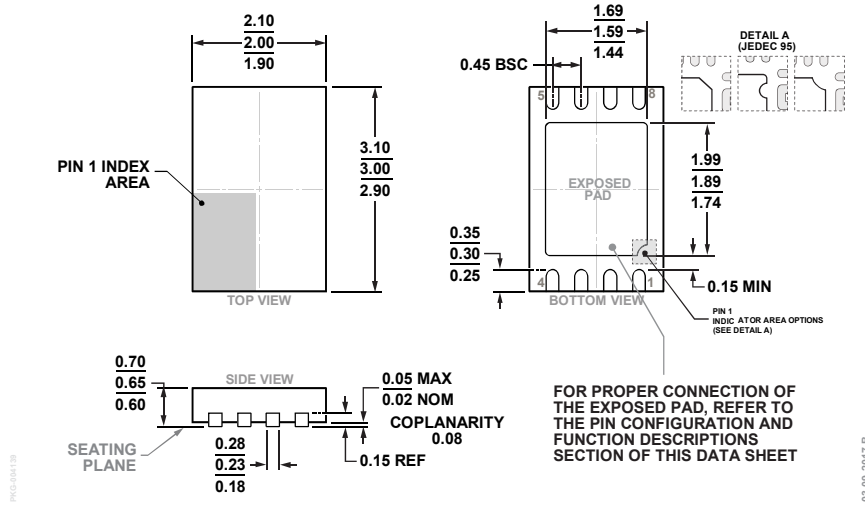

Figure 15. 8-Lead Lead Frame Chip Scale Package [LFCSP]  
 2 mm x 3 mm Body and 0.65 mm Package Height  
 (CP-8-17)  
 Dimensions shown in millimeters

ORDERING GUIDE

Model <sup>1</sup>	Temperature Range	Package Description	Package Option
ADPD2140BCPZN-R7	-40°C to +85°C	8-Lead Lead Frame Chip Scale Package [LFCSP]	CP-8-17
ADPD2140BCPZN-RL	-40°C to +85°C	8-Lead Lead Frame Chip Scale Package [LFCSP]	CP-8-17
EVAL-ADPD2140Z		ADPD2140 Evaluation Board	

<sup>1</sup> Z = RoHS Compliant Part.

Компания «Океан Электроники» предлагает заключение долгосрочных отношений при поставках импортных электронных компонентов на взаимовыгодных условиях!

Наши преимущества:

- Поставка оригинальных импортных электронных компонентов напрямую с производств Америки, Европы и Азии, а так же с крупнейших складов мира;
- Широкая линейка поставок активных и пассивных импортных электронных компонентов (более 30 млн. наименований);
- Поставка сложных, дефицитных, либо снятых с производства позиций;
- Оперативные сроки поставки под заказ (от 5 рабочих дней);
- Экспресс доставка в любую точку России;
- Помощь Конструкторского Отдела и консультации квалифицированных инженеров;
- Техническая поддержка проекта, помощь в подборе аналогов, поставка прототипов;
- Поставка электронных компонентов под контролем ВП;
- Система менеджмента качества сертифицирована по Международному стандарту ISO 9001;
- При необходимости вся продукция военного и аэрокосмического назначения проходит испытания и сертификацию в лаборатории (по согласованию с заказчиком);
- Поставка специализированных компонентов военного и аэрокосмического уровня качества (Xilinx, Altera, Analog Devices, Intersil, Interpoint, Microsemi, Actel, Aeroflex, Peregrine, VPT, Syfer, Eurofarad, Texas Instruments, MS Kennedy, Miteq, Cobham, E2V, MA-COM, Hittite, Mini-Circuits, General Dynamics и др.);

Компания «Океан Электроники» является официальным дистрибьютором и эксклюзивным представителем в России одного из крупнейших производителей разъемов военного и аэрокосмического назначения «JONHON», а так же официальным дистрибьютором и эксклюзивным представителем в России производителя высокотехнологичных и надежных решений для передачи СВЧ сигналов «FORSTAR».



## JONHON

«JONHON» (основан в 1970 г.)

Разъемы специального, военного и аэрокосмического назначения:

(Применяются в военной, авиационной, аэрокосмической, морской, железнодорожной, горно- и нефтедобывающей отраслях промышленности)

«FORSTAR» (основан в 1998 г.)

ВЧ соединители, коаксиальные кабели, кабельные сборки и микроволновые компоненты:

(Применяются в телекоммуникациях гражданского и специального назначения, в средствах связи, РЛС, а так же военной, авиационной и аэрокосмической отраслях промышленности).



Телефон: 8 (812) 309-75-97 (многоканальный)

Факс: 8 (812) 320-03-32

Электронная почта: [ocean@oceanchips.ru](mailto:ocean@oceanchips.ru)

Web: <http://oceanchips.ru/>

Адрес: 198099, г. Санкт-Петербург, ул. Калинина, д. 2, корп. 4, лит. А