

## Simple, Miniature Single-Cell, Fully Integrated Li-Ion / Li-Polymer Charge Management Controllers

### Features

- Complete Linear Charge Management Controller
  - Integrated Pass Transistor
  - Integrated Current Sense
  - Integrated Reverse Discharge Protection
- Constant Current / Constant Voltage Operation with Thermal Regulation
- High Accuracy Preset Voltage Regulation:  $\pm 1\%$
- Voltage Regulation: 4.20V
- Selectable Charge Current:
  - MCP73811: 85 mA / 450 mA
- Programmable Charge Current:
  - MCP73812: 50 mA - 500 mA
- Minimum External Components Required:
  - MCP73811: 2 Ceramic Capacitors
  - MCP73812: 2 Ceramic Capacitors and 1 Resistor
- No Preconditioning
- External End-of-Charge Control
- Automatic Power-Down when Input Power Removed
- Active High Charge Enable
- Temperature Range:
  - $-40^{\circ}\text{C}$  to  $+85^{\circ}\text{C}$
- Packaging:
  - 5-Lead SOT-23

### Applications

- Low-Cost Lithium-Ion/Lithium-Polymer Battery Chargers
- Rechargeable Toys
- Electronic Cigarettes
- Bluetooth Headsets
- USB Chargers

### Description

The MCP73811/2 devices are linear charge management controllers that are designed for use in space limited and cost sensitive applications. The MCP73811/2 provide specific charge algorithms for single cell Li-Ion or Li-Polymer battery to achieve optimal capacity in the shortest charging time possible. Along with its small physical size, the low number of external components required make the MCP73811/2 ideally suited for portable applications. For applications charging from a USB port, the MCP73811 adheres to all the specifications governing the USB power bus.

The MCP73811/2 employ a constant current/constant voltage charge algorithm. The constant voltage regulation is fixed at 4.20V, with a tight regulation tolerance of 1%. For the MCP73811, the constant current value is selected as 85 mA (low power USB port) or 450 mA (high power USB port) with a digital input signal on the PROG input. For the MCP73812, the constant current value is set with one external resistor. The MCP73811/2 limit the charge current based on die temperature during high power or high ambient conditions. This thermal regulation optimizes the charge cycle time while maintaining device reliability.

The MCP73811/2 are fully specified over the ambient temperature range of  $-40^{\circ}\text{C}$  to  $+85^{\circ}\text{C}$ . The MCP73811/2 are available in a 5-Lead, SOT-23 package.

### Package Types

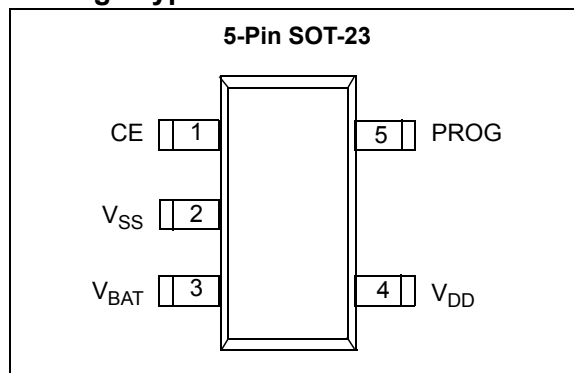

# MCP73811/2

## Typical Applications

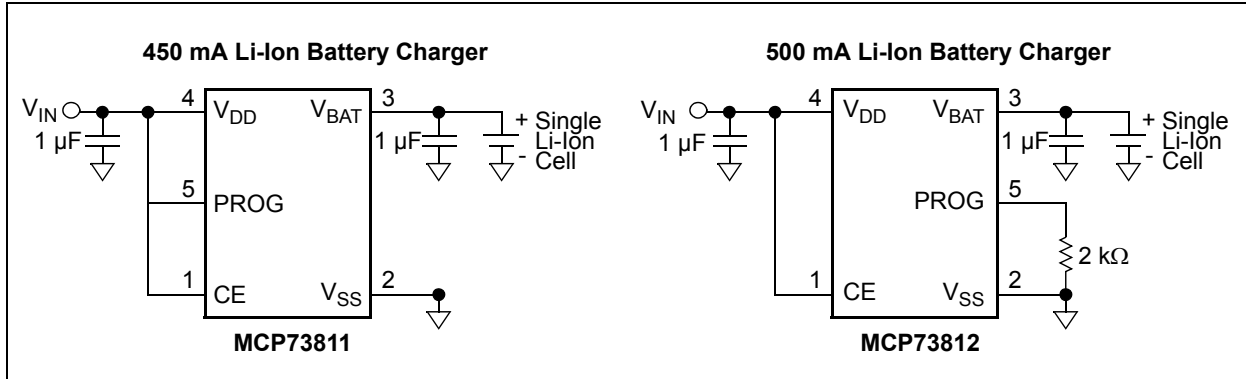

## Functional Block Diagram

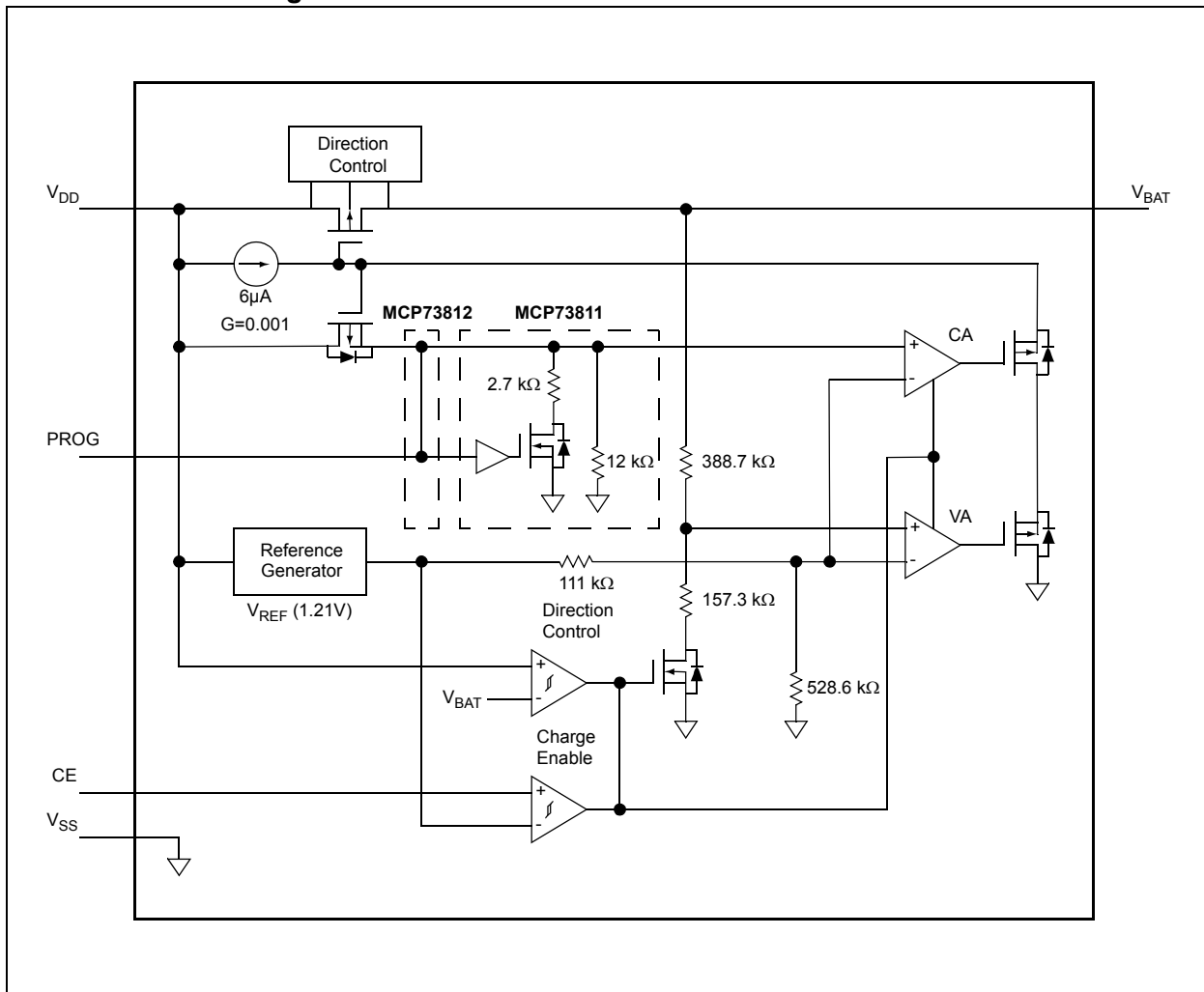

## 1.0 ELECTRICAL CHARACTERISTICS

### Absolute Maximum Ratings†

$V_{DDN}$  ..... 7.0V  
 All Inputs and Outputs w.r.t.  $V_{SS}$  ..... -0.3 to ( $V_{DD}+0.3$ )V

Maximum Junction Temperature,  $T_J$  ..... Internally Limited  
 Storage temperature ..... -65°C to +150°C  
 ESD protection on all pins  
 Human Body Model (1.5 kW in Series with 100 pF) .....  $\geq 4$  kV  
 Machine Model (200pF, No Series Resistance) ..... 400V

† **Notice:** Stresses above those listed under “Maximum Ratings” may cause permanent damage to the device. This is a stress rating only and functional operation of the device at those or any other conditions above those indicated in the operational listings of this specification is not implied. Exposure to maximum rating conditions for extended periods may affect device reliability.

### DC CHARACTERISTICS

<b>Electrical Specifications:</b> Unless otherwise indicated, all limits apply for $V_{DD} = [V_{REG}(typ.) + 0.3V]$ to 6V, $T_A = -40^\circ C$ to $+85^\circ C$ . Typical values are at $+25^\circ C$ , $V_{DD} = [V_{REG}(typ.) + 1.0V]$						
Parameters	Sym	Min	Typ	Max	Units	Conditions
<b>Supply Input</b>						
Supply Voltage	$V_{DD}$	3.75	—	6	V	
Supply Current	$I_{SS}$	—	1000	1500	$\mu A$	Charging
		—	50	100	$\mu A$	Standby ( $CE = V_{SS}$ )
		—	1.2	5	$\mu A$	Shutdown ( $V_{DD} \leq V_{BAT} - 100$ mV)
<b>Voltage Regulation (Constant Voltage Mode)</b>						
Regulated Output Voltage	$V_{REG}$	—	4.20	—	V	$V_{DD} = [V_{REG}(Typ) + 1V]$ $I_{OUT} = 10$ mA
Output Voltage Tolerance	$V_{RTOL}$	-1	—	+1	%	$T_A = -5^\circ C$ to $+55^\circ C$
Line Regulation	$ \frac{\Delta V_{BAT}/V_{BAT}}{\Delta V_{DD}} $	—	0.09	0.30	%/V	$V_{DD} = [V_{REG}(Typ) + 1V]$ to 6V $I_{OUT} = 10$ mA
Load Regulation	$ \frac{\Delta V_{BAT}/V_{BAT}}{\Delta I_{OUT}} $	—	0.09	0.30	%	$I_{OUT} = 10$ mA to 50 mA $V_{DD} = [V_{REG}(Typ) + 1V]$
Supply Ripple Attenuation	PSRR	—	52	—	dB	$I_{OUT} = 10$ mA, 10 Hz to 1 kHz
		—	47	—	dB	$I_{OUT} = 10$ mA, 10 Hz to 10 kHz
		—	22	—	dB	$I_{OUT} = 10$ mA, 10 Hz to 1 MHz
<b>Current Regulation (Fast Charge Constant-Current Mode)</b>						
Fast Charge Current Regulation	$I_{REG}$	—	85	—	mA	MCP73811 - PROG = Low
		—	450	—	mA	MCP73811 - PROG = High
		—	50	—	mA	MCP73812 - PROG = 20 k $\Omega$
		—	100	—	mA	MCP73812 - PROG = 10 k $\Omega$
		—	500	—	mA	MCP73812 - PROG = 2 k $\Omega$
Charge Current Tolerance	$I_{RTOL}$	-10	—	+10	%	$T_A = -5^\circ C$ to $+55^\circ C$
<b>Pass Transistor ON-Resistance</b>						
ON-Resistance	$R_{DSON}$	—	400	—	m $\Omega$	$V_{DD} = 3.75V$ , $T_J = 105^\circ C$
<b>Battery Discharge Current</b>						
Output Reverse Leakage Current	$I_{DISCHARGE}$	—	0.5	2	$\mu A$	Shutdown ( $V_{DD} \leq V_{BAT} - 100$ mV)

# MCP73811/2

## DC CHARACTERISTICS (Continued)

<b>Electrical Specifications:</b> Unless otherwise indicated, all limits apply for $V_{DD} = [V_{REG}(typ.) + 0.3V]$ to 6V, $T_A = -40^{\circ}C$ to $+85^{\circ}C$ . Typical values are at $+25^{\circ}C$ , $V_{DD} = [V_{REG}(typ.) + 1.0V]$						
Parameters	Sym	Min	Typ	Max	Units	Conditions
<b>Charge Enable (CE), PROG Input - MCP73811</b>						
Input High Voltage Level	$V_{IH}$	2	—	—	V	
Input Low Voltage Level	$V_{IL}$	—	—	0.8	V	
Input Leakage Current	$I_{LK}$	—	0.01	1	$\mu A$	$V_{CE} = V_{DD}$ , $V_{PROG} = V_{DD}$
<b>PROG Input - MCP73812</b>						
Charge Impedance Range	$R_{PROG}$	2	—	20	$k\Omega$	MCP73812
<b>Automatic Power Down (Direction Control)</b>						
Automatic Power Down Entry Threshold	$V_{PD}$	$V_{BAT} + 10\text{ mV}$	$V_{BAT} + 50\text{ mV}$	—	V	$2.3V \leq V_{BAT} \leq V_{REG}$ $V_{DD}$ Falling
Automatic Power Down Exit Threshold	$V_{PDEXIT}$	—	$V_{BAT} + 150\text{ mV}$	$V_{BAT} + 250\text{ mV}$	V	$2.3V \leq V_{BAT} \leq V_{REG}$ $V_{DD}$ Rising
<b>Thermal Shutdown</b>						
Die Temperature	$T_{SD}$	—	150	—	$^{\circ}C$	
Die Temperature Hysteresis	$T_{SDHYS}$	—	10	—	$^{\circ}C$	

## TEMPERATURE SPECIFICATIONS

<b>Electrical Specifications:</b> Unless otherwise indicated, all limits apply for $V_{DD} = [V_{REG}(typ.) + 0.3V]$ to 6V. Typical values are at $+25^{\circ}C$ , $V_{DD} = [V_{REG}(typ.) + 1.0V]$						
Parameters	Sym	Min	Typ	Max	Units	Conditions
<b>Temperature Ranges</b>						
Specified Temperature Range	$T_A$	-40	—	+85	$^{\circ}C$	
Operating Temperature Range	$T_J$	-40	—	+125	$^{\circ}C$	
Storage Temperature Range	$T_A$	-65	—	+150	$^{\circ}C$	
<b>Thermal Package Resistances</b>						
Thermal Resistance, 5-Lead, SOT-23	$\theta_{JA}$	—	230	—	$^{\circ}C/W$	4-Layer JC51-7 Standard Board, Natural Convection

## 2.0 TYPICAL PERFORMANCE CURVES

**Note:** The graphs and tables provided following this note are a statistical summary based on a limited number of samples and are provided for informational purposes only. The performance characteristics listed herein are not tested or guaranteed. In some graphs or tables, the data presented may be outside the specified operating range (e.g., outside specified power supply range) and therefore outside the warranted range.

**Note:** Unless otherwise indicated,  $V_{DD} = [V_{REG}(typ.) + 1V]$ ,  $I_{OUT} = 10\text{ mA}$  and  $T_A = +25^\circ\text{C}$ , Constant-voltage mode.

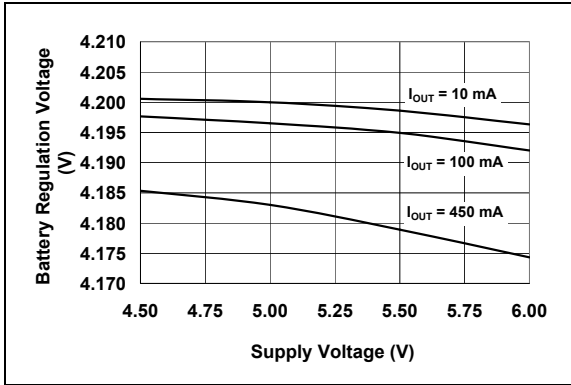

**FIGURE 2-1:** Battery Regulation Voltage ( $V_{BAT}$ ) vs. Supply Voltage ( $V_{DD}$ ).

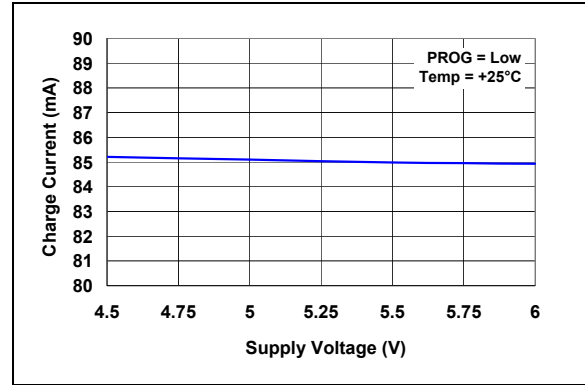

**FIGURE 2-4:** Charge Current ( $I_{OUT}$ ) vs. Supply Voltage ( $V_{DD}$ ) - MCP73811.

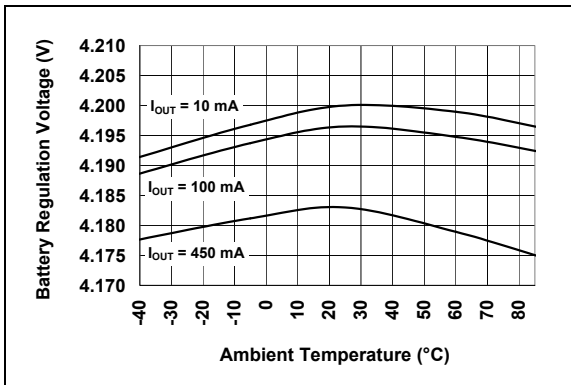

**FIGURE 2-2:** Battery Regulation Voltage ( $V_{BAT}$ ) vs. Ambient Temperature ( $T_A$ ).

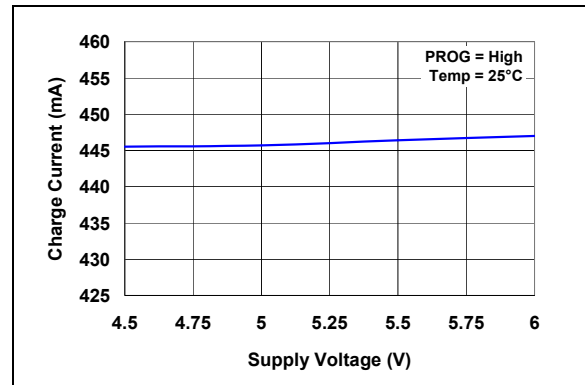

**FIGURE 2-5:** Charge Current ( $I_{OUT}$ ) vs. Supply Voltage ( $V_{DD}$ ) - MCP73811.

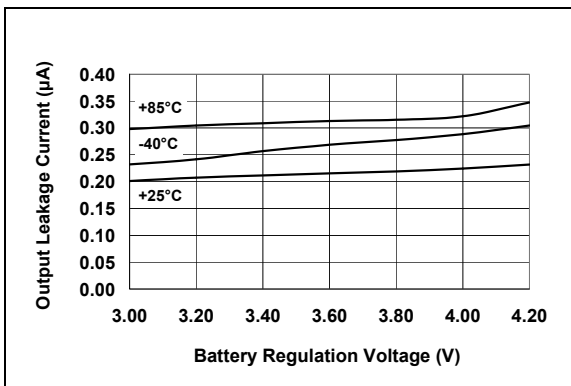

**FIGURE 2-3:** Output Leakage Current ( $I_{DISCHARGE}$ ) vs. Battery Regulation Voltage ( $V_{BAT}$ ).

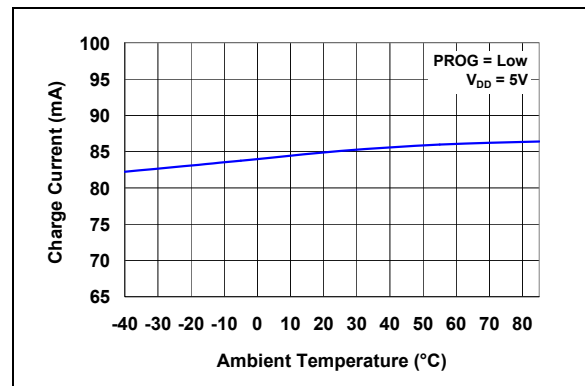
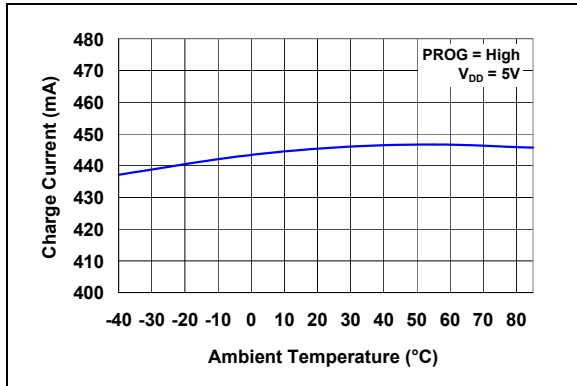

**FIGURE 2-6:** Charge Current ( $I_{OUT}$ ) vs. Ambient Temperature ( $T_A$ ) - MCP73811.

# MCP73811/2

## Typical Performance Curves (Continued)

Note: Unless otherwise indicated,  $V_{DD} = [V_{REG}(typ.) + 1V]$ ,  $I_{OUT} = 10\text{ mA}$  and  $T_A = +25^\circ\text{C}$ , Constant-voltage mode.



**FIGURE 2-7:** Charge Current ( $I_{OUT}$ ) vs. Ambient Temperature ( $T_A$ ) - MCP73811.

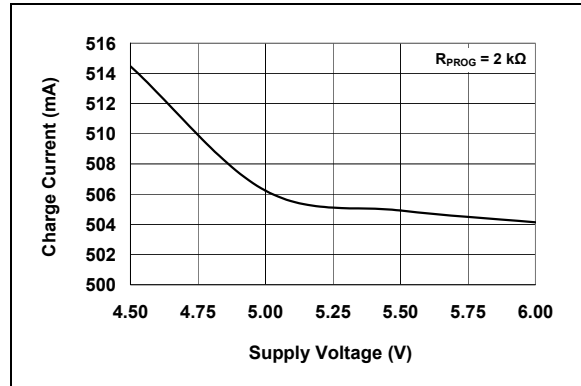

**FIGURE 2-10:** Charge Current ( $I_{OUT}$ ) vs. Supply Voltage ( $V_{DD}$ ) - MCP73812.

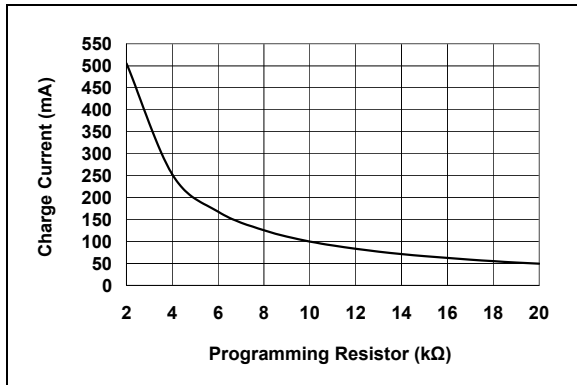

**FIGURE 2-8:** Charge Current ( $I_{OUT}$ ) vs. Programming Resistor ( $R_{PROG}$ ) - MCP73812.

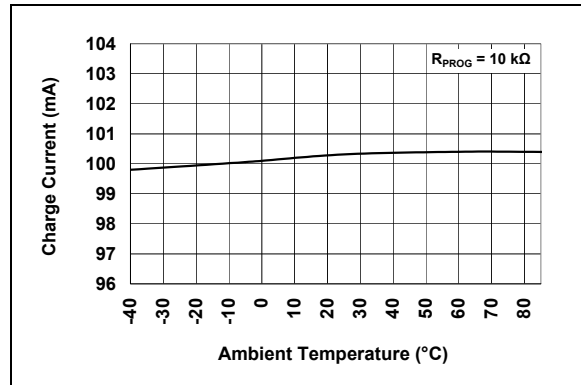

**FIGURE 2-11:** Charge Current ( $I_{OUT}$ ) vs. Ambient Temperature ( $T_A$ ) - MCP73812.

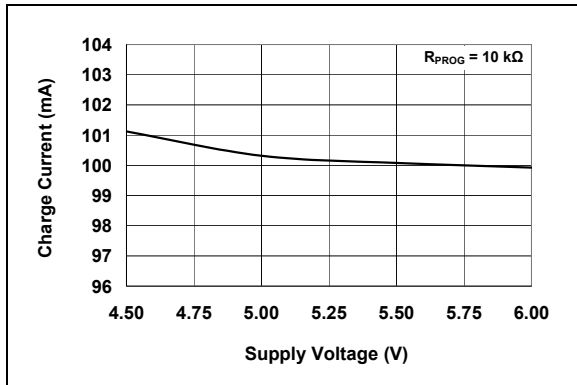

**FIGURE 2-9:** Charge Current ( $I_{OUT}$ ) vs. Supply Voltage ( $V_{DD}$ ) - MCP73812.

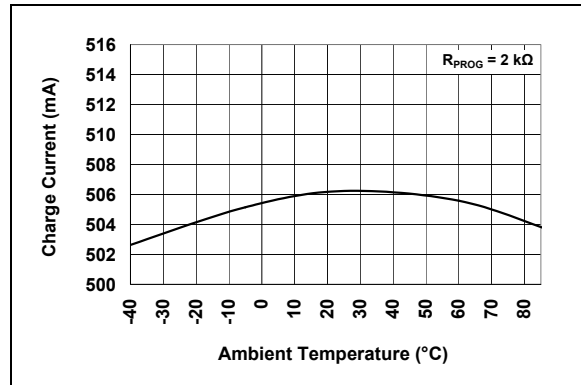

**FIGURE 2-12:** Charge Current ( $I_{OUT}$ ) vs. Ambient Temperature ( $T_A$ ) - MCP73812.

## Typical Performance Curves (Continued)

Note: Unless otherwise indicated,  $V_{DD} = [V_{REG}(typ.) + 1V]$ ,  $I_{OUT} = 10\text{ mA}$  and  $T_A = +25^\circ\text{C}$ , Constant-voltage mode.

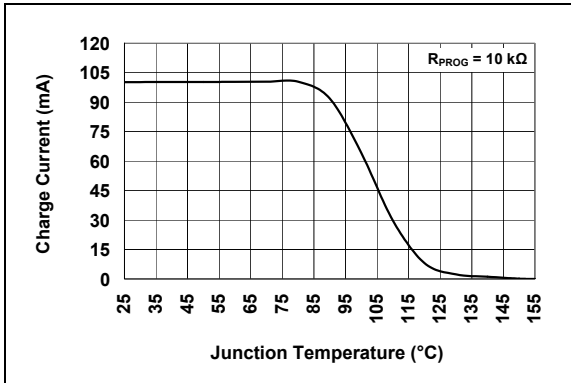

**FIGURE 2-13:** Charge Current ( $I_{OUT}$ ) vs. Junction Temperature ( $T_J$ ) - MCP73812.

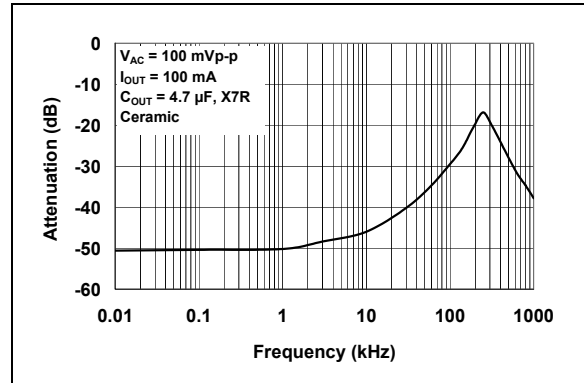

**FIGURE 2-16:** Power Supply Ripple Rejection (PSRR).

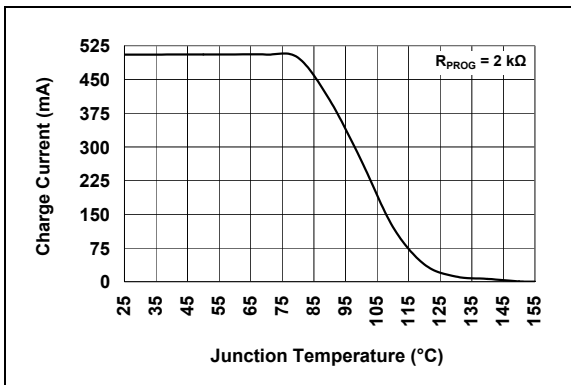

**FIGURE 2-14:** Charge Current ( $I_{OUT}$ ) vs. Junction Temperature ( $T_J$ ) - MCP73812.

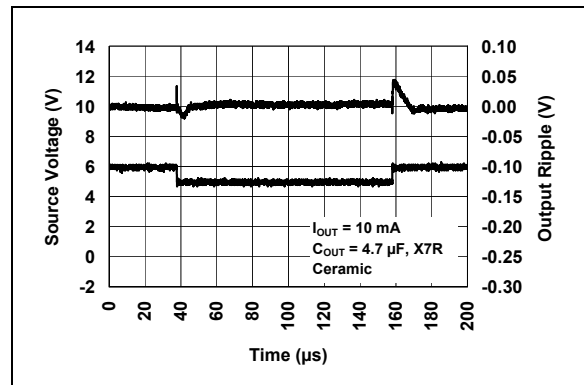

**FIGURE 2-17:** Line Transient Response.

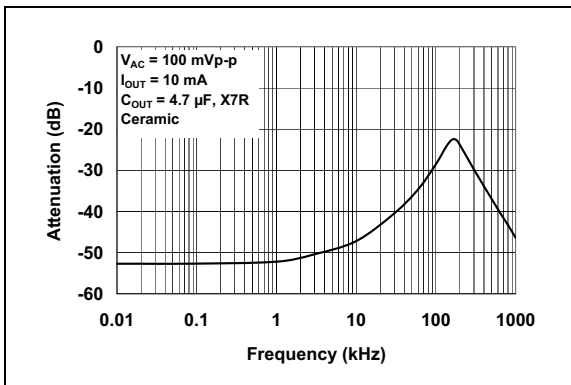

**FIGURE 2-15:** Power Supply Ripple Rejection (PSRR).

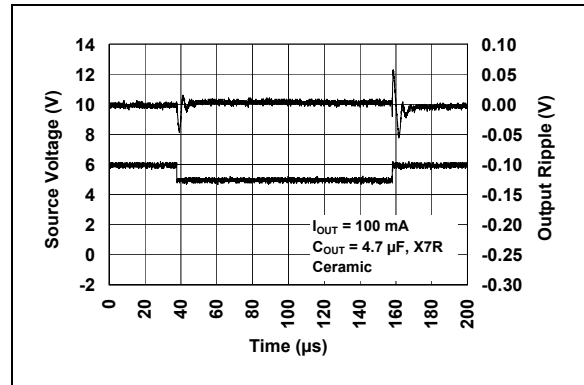

**FIGURE 2-18:** Line Transient Response.

# MCP73811/2

## Typical Performance Curves (Continued)

Note: Unless otherwise indicated,  $V_{DD} = [V_{REG}(typ.) + 1V]$ ,  $I_{OUT} = 10\text{ mA}$  and  $T_A = +25^\circ\text{C}$ , Constant-voltage mode.

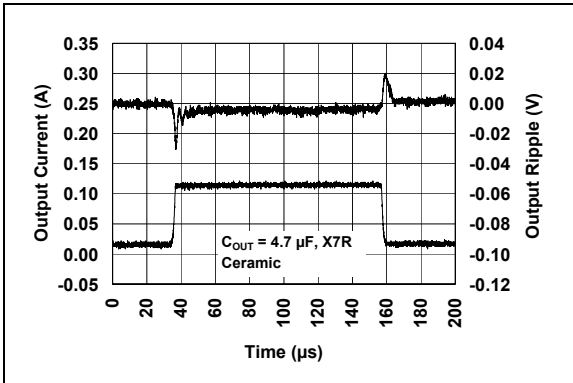

FIGURE 2-19: Load Transient Response.

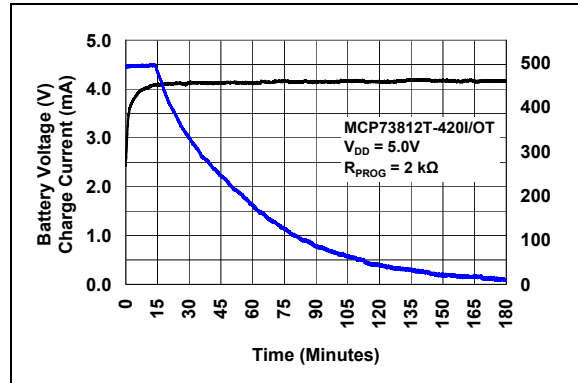

FIGURE 2-21: Typical Charge Profile (950 mAh) Li-Ion Battery.

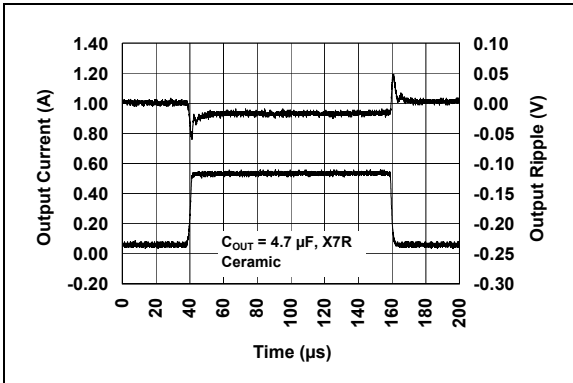

FIGURE 2-20: Load Transient Response.



## 3.0 PIN DESCRIPTION

The descriptions of the pins are listed in Table 3-1.

**TABLE 3-1: PIN FUNCTION TABLES**

Pin Number	Symbol	Function
SOT-23-5		
1	CE	Active High Charge Enable
2	V <sub>SS</sub>	Battery Management 0V Reference
3	V <sub>BAT</sub>	Battery Charge Control Output
4	V <sub>DD</sub>	Battery Management Input Supply
5	PROG	Current Regulation Set and Charge Control Enable

### 3.1 Charge Enable Input (CE)

A logic High enables battery charging. A logic Low disables battery charging. The charge enable input is compatible with 1.8V logic.

### 3.2 Battery Management 0V Reference (V<sub>SS</sub>)

Connect to negative terminal of battery and input supply.

### 3.3 Battery Charge Control Output (V<sub>BAT</sub>)

Connect to positive terminal of battery. Drain terminal of internal P-channel MOSFET pass transistor. Bypass to V<sub>SS</sub> with a minimum of 1  $\mu$ F to ensure loop stability when the battery is disconnected.

### 3.4 Battery Management Input Supply (V<sub>DD</sub>)

A supply voltage of [V<sub>REG</sub> (typ.) + 0.3V] to 6V is recommended. Bypass to V<sub>SS</sub> with a minimum of 1  $\mu$ F.

### 3.5 Current Regulation Set (PROG)

For the MCP73811, the current regulation set input (PROG) functions as a digital input selection. A logic Low selects a 85 mA charge current; a logic High selects a 450 mA charge current.

For the MCP73812, the charge current is set by placing a resistor from PROG to V<sub>SS</sub>.

# MCP73811/2

## 4.0 DEVICE OVERVIEW

The MCP73811/2 are simple, but fully integrated linear charge management controllers. Figure 4-1 depicts the operational flow algorithm.

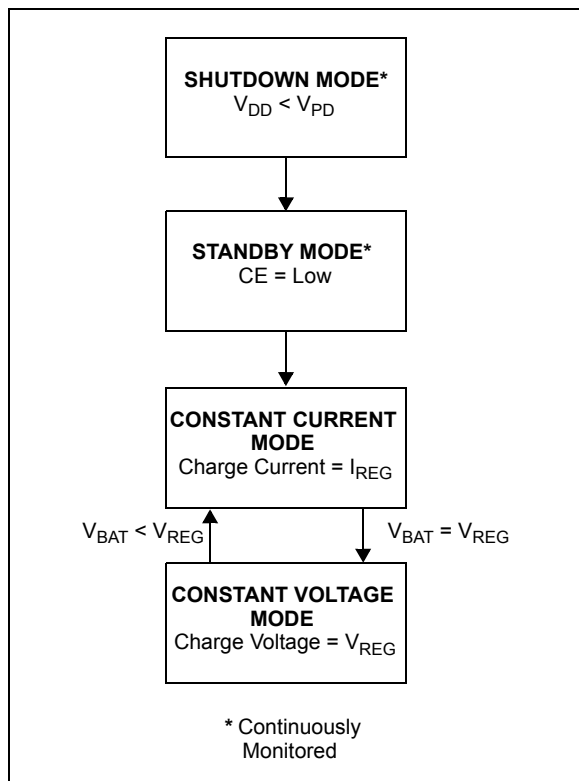

FIGURE 4-1: Flow Chart.

### 4.1 Undervoltage Lockout (UVLO)

The MCP73811/2 does not have an internal under voltage lockout (UVLO) circuit.

### 4.2 Charge Qualification

When the input power is applied, the input supply must rise 150 mV above the battery voltage before the MCP73811/2 becomes operational.

The automatic power down circuit places the device in a shutdown mode if the input supply falls to within +50 mV of the battery voltage.

The automatic circuit is always active. Whenever the input supply is within +50 mV of the voltage at the V<sub>BAT</sub> pin, the MCP73811/2 is placed in a shutdown mode.

During power down condition, the battery reverse discharge current is less than 2 μA.

For a charge cycle to begin, the automatic power down conditions must be met and the charge enable input must be above the input high threshold.

## 4.3 PRECONDITIONING

The MCP73811/2 does not support preconditioning of deeply depleted cells.

### 4.4 Constant Current MODE - Fast Charge

During the constant current mode, the selected (MCP73811) or programmed (MCP73812) charge current is supplied to the battery or load.

For the MCP73812, the charge current is established using a single resistor from PROG to V<sub>SS</sub>. The program resistor and the charge current are calculated using the following equation:

#### EQUATION 4-1:

$$I_{REG} = \frac{1000V}{R_{PROG}}$$

Where:

R <sub>PROG</sub>	=	kilo-ohms
I <sub>REG</sub>	=	milliamperes

Constant current mode is maintained until the voltage at the V<sub>BAT</sub> pin reaches the regulation voltage, V<sub>REG</sub>.

### 4.5 Constant Voltage Mode

When the voltage at the V<sub>BAT</sub> pin reaches the regulation voltage, V<sub>REG</sub>, constant voltage regulation begins. The regulation voltage is factory set to 4.20V with a tolerance of ±1.0%.

### 4.6 Charge Termination

The charge cycle is terminated by removing the battery from the charger, removing input power, or driving the charge enable input (CE) to a logic Low. An automatic charge termination method is not implemented.

### 4.7 Automatic Recharge

The MCP73811/2 does not support automatic recharge cycles since automatic charge termination has not been implemented. In essence, the MCP73811/2 is always in a charge cycle whenever the qualification parameters have been met.

## 4.8 Thermal Regulation

The MCP73811/2 limits the charge current based on the die temperature. The thermal regulation optimizes the charge cycle time while maintaining device reliability. Figure 4-2 depicts the thermal regulation for the MCP73811/2.

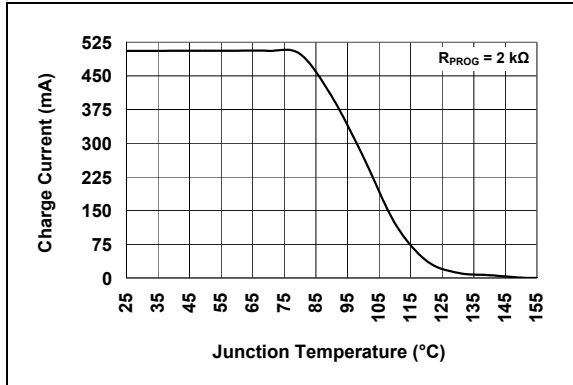

**FIGURE 4-2:** Thermal Regulation.

## 4.9 Thermal Shutdown

The MCP73811/2 suspends charge if the die temperature exceeds 150°C. Charging will resume when the die temperature has cooled by approximately 10°C. The thermal shutdown is a secondary safety feature in the event that there is a failure within the thermal regulation circuitry.

# MCP73811/2

---

## 5.0 DETAILED DESCRIPTION

### 5.1 Analog Circuitry

#### 5.1.1 BATTERY MANAGEMENT INPUT SUPPLY ( $V_{DD}$ )

The  $V_{DD}$  input is the input supply to the MCP73811/2. The MCP73811/2 automatically enters a Power-down mode if the voltage on the  $V_{DD}$  input falls to within +50 mV of the battery voltage. This feature prevents draining the battery pack when the  $V_{DD}$  supply is not present.

#### 5.1.2 MCP73812 CURRENT REGULATION SET (PROG)

For the MCP73812, the charge current regulation can be scaled by placing a programming resistor ( $R_{PROG}$ ) from the PROG input to  $V_{SS}$ . The program resistor and the charge current are calculated using the following equation:

#### EQUATION 5-1:

$$I_{REG} = \frac{1000V}{R_{PROG}}$$

Where:

$$\begin{aligned} R_{PROG} &= \text{kilo-ohms} \\ I_{REG} &= \text{milliamperes} \end{aligned}$$

#### 5.1.3 BATTERY CHARGE CONTROL OUTPUT ( $V_{BAT}$ )

The battery charge control output is the drain terminal of an internal P-channel MOSFET. The MCP73811/2 provides constant current and voltage regulation to the battery pack by controlling this MOSFET in the linear region. The battery charge control output should be connected to the positive terminal of the battery pack.

## 5.2 Digital Circuitry

### 5.2.1 CHARGE ENABLE (CE)

The charge enable input pin (CE) can be used to terminate a charge at any time during the charge cycle, as well as to initiate a charge cycle or initiate a recharge cycle.

Driving the input to a logic High enables the device. Driving the input to a logic Low disables the device and terminates a charge cycle. When disabled, the device's supply current is reduced to 50  $\mu$ A, typically.

### 5.2.2 MCP73811 CURRENT REGULATION SELECT (PROG)

For the MCP73811, driving the PROG input to a logic Low selects the low charge current setting (85 mA). Driving the PROG input to a logic High selects the high charge current setting (450 mA).

## 6.0 APPLICATIONS

The MCP73811/2 is designed to operate in conjunction with a host microcontroller or in stand-alone applications. The MCP73811/2 provides the preferred

charge algorithm for Lithium-Ion and Lithium-Polymer cells Constant-current followed by Constant-voltage. [Figure 6-1](#) depicts a typical stand-alone application circuit, while [Figures 6-2](#) depict the accompanying charge profile.

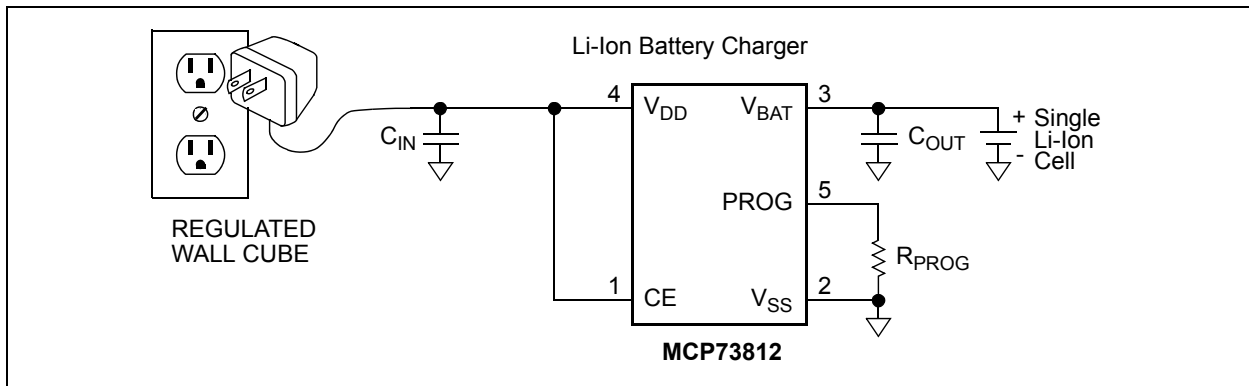

**FIGURE 6-1:** Typical Application Circuit.

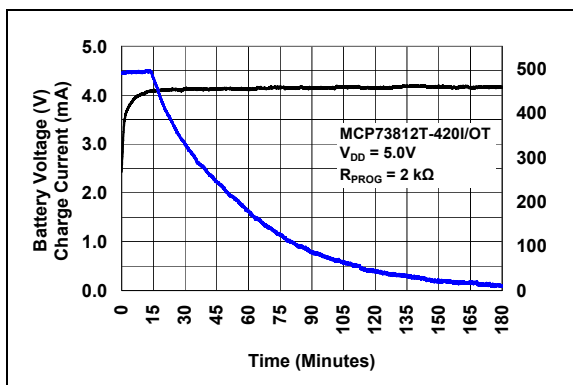

**FIGURE 6-2:** Typical Charge Profile (950 mAh Li-Ion Battery).

## 6.1 Application Circuit Design

Due to the low efficiency of linear charging, the most important factors are thermal design and cost, which are a direct function of the input voltage, output current and thermal impedance between the battery charger and the ambient cooling air. The worst-case situation is when the device has transitioned from the Preconditioning mode to the Constant-current mode. In this situation, the battery charger has to dissipate the maximum power. A trade-off must be made between the charge current, cost and thermal requirements of the charger.

### 6.1.1 COMPONENT SELECTION

Selection of the external components in [Figure 6-1](#) is crucial to the integrity and reliability of the charging system. The following discussion is intended as a guide for the component selection process.

#### 6.1.1.1 Charge Current

The preferred fast charge current for Lithium-Ion cells is at the 1C rate, with an absolute maximum current at the 2C rate. For example, a 500 mAh battery pack has a preferred fast charge current of 500 mA. Charging at this rate provides the shortest charge cycle times without degradation to the battery pack performance or life.

# MCP73811/2

## 6.1.1.2 Thermal Considerations

The worst-case power dissipation in the battery charger occurs when the input voltage is at the maximum and the device has transitioned from the Preconditioning mode to the Constant-current mode. In this case, the power dissipation is:

### EQUATION 6-1:

$$PowerDissipation = (V_{DDMAX} - V_{PTHMIN}) \times I_{REGMAX}$$

Where:

- $V_{DDMAX}$  = the maximum input voltage
- $I_{REGMAX}$  = the maximum fast charge current
- $V_{PTHMIN}$  = the minimum transition threshold voltage

Power dissipation with a 5V, ±10% input voltage source is:

### EQUATION 6-2:

$$PowerDissipation = (5.5V - 2.7V) \times 500mA = 1.4W$$

This power dissipation with the battery charger in the SOT-23-5 package will cause thermal regulation to be entered as depicted in [Figure 6-3](#).

## 6.1.1.3 External Capacitors

The MCP73811/2 is stable with or without a battery load. In order to maintain good AC stability in the Constant-voltage mode, a minimum capacitance of 1 µF is recommended to bypass the  $V_{BAT}$  pin to  $V_{SS}$ . This capacitance provides compensation when there is no battery load. In addition, the battery and interconnections appear inductive at high frequencies. These elements are in the control feedback loop during Constant-voltage mode. Therefore, the bypass capacitance may be necessary to compensate for the inductive nature of the battery pack.

Virtually any good quality output filter capacitor can be used, independent of the capacitor's minimum Effective Series Resistance (ESR) value. The actual value of the capacitor (and its associated ESR) depends on the output load current. A 1 µF ceramic, tantalum or aluminum electrolytic capacitor at the output is usually sufficient to ensure stability for output currents up to a 500 mA.

## 6.1.1.4 Reverse-Blocking Protection

The MCP73811/2 provides protection from a faulted or shorted input. Without the protection, a faulted or shorted input would discharge the battery pack through the body diode of the internal pass transistor.

## 6.1.1.5 Charge Inhibit

The charge enable input pin (CE) can be used to terminate a charge at any time during the charge cycle, as well as to initiate a charge cycle or initiate a recharge cycle.

Driving the input to a logic High enables the device. Driving the input to a logic Low disables the device and terminates a charge cycle. When disabled, the device's supply current is reduced to 50 µA, typically.

## 6.2 PCB Layout Issues

For optimum voltage regulation, place the battery pack as close as possible to the device's  $V_{BAT}$  and  $V_{SS}$  pins, recommended to minimize voltage drops along the high current-carrying PCB traces.

If the PCB layout is used as a heatsink, adding many vias in the heatsink pad can help conduct more heat to the backplane of the PCB, thus reducing the maximum junction temperature. [Figures 6-3](#) and [6-4](#) depict a typical layout with PCB heatsinking.

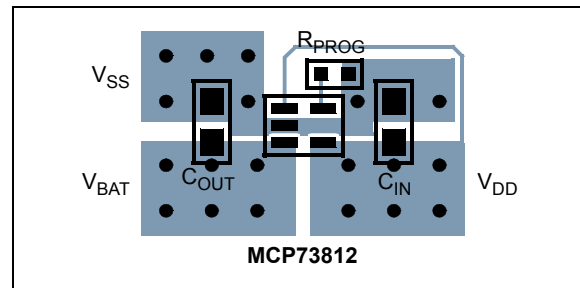

FIGURE 6-3: Typical Layout (Top).

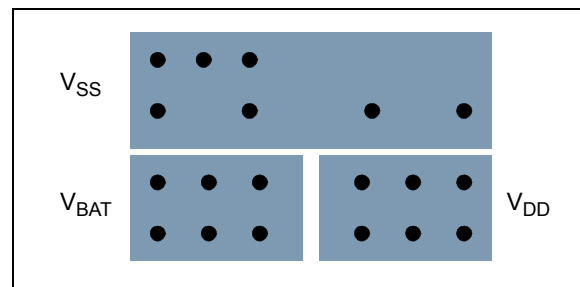
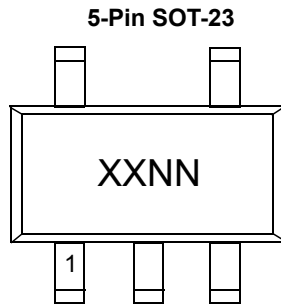

FIGURE 6-4: Typical Layout (Bottom).

## 7.0 PACKAGE INFORMATION

### 7.1 Package Marking Information



Standard *	
Part Number	Code
MCP73811T-420I/OT	KSNN
MCP73812T-420I/OT	KWNN

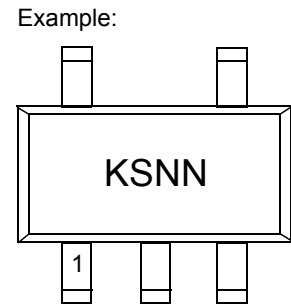

\* Custom output voltages available upon request.

Contact your local Microchip sales office for more information.

<b>Legend:</b>	XX...X	Customer-specific information
	Y	Year code (last digit of calendar year)
	YY	Year code (last 2 digits of calendar year)
	WW	Week code (week of January 1 is week '01')
	NNN	Alphanumeric traceability code
	(e3)	Pb-free JEDEC designator for Matte Tin (Sn)
	*	This package is Pb-free. The Pb-free JEDEC designator (e3) can be found on the outer packaging for this package.

**Note:** In the event the full Microchip part number cannot be marked on one line, it will be carried over to the next line, thus limiting the number of available characters for customer-specific information.

# MCP73811/2

## 5-Lead Plastic Small Outline Transistor (OT) [SOT-23]

**Note:** For the most current package drawings, please see the Microchip Packaging Specification located at <http://www.microchip.com/packaging>

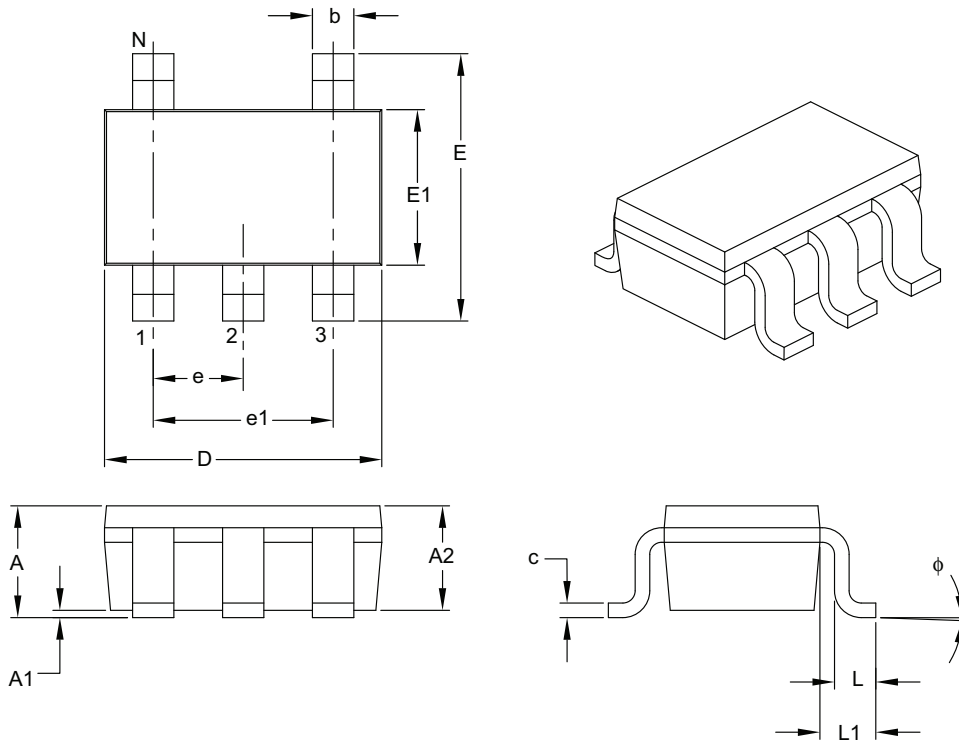

		Units	MILLIMETERS		
Dimension Limits			MIN	NOM	MAX
Number of Pins	N		5		
Lead Pitch	e		0.95 BSC		
Outside Lead Pitch	e1		1.90 BSC		
Overall Height	A	0.90	–		1.45
Molded Package Thickness	A2	0.89	–		1.30
Standoff	A1	0.00	–		0.15
Overall Width	E	2.20	–		3.20
Molded Package Width	E1	1.30	–		1.80
Overall Length	D	2.70	–		3.10
Foot Length	L	0.10	–		0.60
Footprint	L1	0.35	–		0.80
Foot Angle	$\phi$	0°	–		30°
Lead Thickness	c	0.08	–		0.26
Lead Width	b	0.20	–		0.51

**Notes:**

- Dimensions D and E1 do not include mold flash or protrusions. Mold flash or protrusions shall not exceed 0.127 mm per side.
- Dimensioning and tolerancing per ASME Y14.5M.

BSC: Basic Dimension. Theoretically exact value shown without tolerances.

Microchip Technology Drawing C04-091B



## **APPENDIX A: REVISION HISTORY**

### **Revision B (September 2007)**

The following is the list of modifications:

1. Modified "No End-of-Charge Control" bullet to read "External End-of-Charge Control".
2. Deleted No Undervoltage Lockout (UVLO) bullet
3. Replaced Figure 2-21 with new plot and changed figure caption.
4. Deleted Figure 2-22.
5. Replaced Figure 6-2 with new plot and changed figure caption.
6. Deleted Figure 6-3.
7. Updated revision history.

### **Revision A (March 2007)**

- Original Release of this Document.

# MCP73811/2

---

NOTES:

## PRODUCT IDENTIFICATION SYSTEM

To order or obtain information, e.g., on pricing or delivery, refer to the factory or the listed sales office.

<u>PART NO.</u>	—	<u>XXX</u>	<u>X</u>	<u>/XX</u>
Device		Voltage Options	Temperature	Package
Device:		MCP73811T: Li-Ion Charger w/Selectable Charge Current, Tape and Reel MCP73812T: Li-Ion Charger w/Selectable Charge Current, Tape and Reel		
Voltage Options *:		420 = 4.2V "Standard" *Contact factory for other output voltage options.		
Temperature:		I = -40°C to +85°C		
Package Type:		OT = Small Outline Transistor (SOT-23), 5-lead		

**Examples:**

- a) MCP73811T-420I/OT: 4.2V Charger SOT-23-5 pkg.
- a) MCP73812T-420I/OT: 4.2V Charger SOT-23-5 pkg.

# MCP73811/2

---

NOTES:

---

**Note the following details of the code protection feature on Microchip devices:**

- Microchip products meet the specification contained in their particular Microchip Data Sheet.
- Microchip believes that its family of products is one of the most secure families of its kind on the market today, when used in the intended manner and under normal conditions.
- There are dishonest and possibly illegal methods used to breach the code protection feature. All of these methods, to our knowledge, require using the Microchip products in a manner outside the operating specifications contained in Microchip's Data Sheets. Most likely, the person doing so is engaged in theft of intellectual property.
- Microchip is willing to work with the customer who is concerned about the integrity of their code.
- Neither Microchip nor any other semiconductor manufacturer can guarantee the security of their code. Code protection does not mean that we are guaranteeing the product as “unbreakable.”

Code protection is constantly evolving. We at Microchip are committed to continuously improving the code protection features of our products. Attempts to break Microchip's code protection feature may be a violation of the Digital Millennium Copyright Act. If such acts allow unauthorized access to your software or other copyrighted work, you may have a right to sue for relief under that Act.

---

Information contained in this publication regarding device applications and the like is provided only for your convenience and may be superseded by updates. It is your responsibility to ensure that your application meets with your specifications. MICROCHIP MAKES NO REPRESENTATIONS OR WARRANTIES OF ANY KIND WHETHER EXPRESS OR IMPLIED, WRITTEN OR ORAL, STATUTORY OR OTHERWISE, RELATED TO THE INFORMATION, INCLUDING BUT NOT LIMITED TO ITS CONDITION, QUALITY, PERFORMANCE, MERCHANTABILITY OR FITNESS FOR PURPOSE. Microchip disclaims all liability arising from this information and its use. Use of Microchip devices in life support and/or safety applications is entirely at the buyer's risk, and the buyer agrees to defend, indemnify and hold harmless Microchip from any and all damages, claims, suits, or expenses resulting from such use. No licenses are conveyed, implicitly or otherwise, under any Microchip intellectual property rights.

**Trademarks**

The Microchip name and logo, the Microchip logo, Accuron, dsPIC, KEELOQ, KEELOQ logo, microID, MPLAB, PIC, PICmicro, PICSTART, PRO MATE, rPIC and SmartShunt are registered trademarks of Microchip Technology Incorporated in the U.S.A. and other countries.

AmpLab, FilterLab, Linear Active Thermistor, Migratable Memory, MXDEV, MXLAB, SEEVAL, SmartSensor and The Embedded Control Solutions Company are registered trademarks of Microchip Technology Incorporated in the U.S.A.

Analog-for-the-Digital Age, Application Maestro, CodeGuard, dsPICDEM, dsPICDEM.net, dsPICworks, dsSPEAK, ECAN, ECONOMONITOR, FanSense, FlexROM, fuzzyLAB, In-Circuit Serial Programming, ICSP, ICEPIC, Mindi, MiWi, MPASM, MPLAB Certified logo, MPLIB, MPLINK, PICkit, PICDEM, PICDEM.net, PICLAB, PICtail, PowerCal, PowerInfo, PowerMate, PowerTool, REAL ICE, rLAB, Select Mode, Smart Serial, SmartTel, Total Endurance, UNI/O, WiperLock and ZENA are trademarks of Microchip Technology Incorporated in the U.S.A. and other countries.

SQTP is a service mark of Microchip Technology Incorporated in the U.S.A.

All other trademarks mentioned herein are property of their respective companies.

© 2007, Microchip Technology Incorporated, Printed in the U.S.A., All Rights Reserved.

 Printed on recycled paper.

**QUALITY MANAGEMENT SYSTEM  
CERTIFIED BY DNV  
== ISO/TS 16949:2002 ==**

*Microchip received ISO/TS-16949:2002 certification for its worldwide headquarters, design and wafer fabrication facilities in Chandler and Tempe, Arizona; Gresham, Oregon and design centers in California and India. The Company's quality system processes and procedures are for its PIC® MCUs and dsPIC® DSCs, KEELOQ® code hopping devices, Serial EEPROMs, microperipherals, nonvolatile memory and analog products. In addition, Microchip's quality system for the design and manufacture of development systems is ISO 9001:2000 certified.*



---

---

## WORLDWIDE SALES AND SERVICE

---

---

### AMERICAS

**Corporate Office**  
2355 West Chandler Blvd.  
Chandler, AZ 85224-6199  
Tel: 480-792-7200  
Fax: 480-792-7277  
Technical Support:  
<http://support.microchip.com>  
Web Address:  
[www.microchip.com](http://www.microchip.com)

#### Atlanta

Duluth, GA  
Tel: 678-957-9614  
Fax: 678-957-1455

#### Boston

Westborough, MA  
Tel: 774-760-0087  
Fax: 774-760-0088

#### Chicago

Itasca, IL  
Tel: 630-285-0071  
Fax: 630-285-0075

#### Dallas

Addison, TX  
Tel: 972-818-7423  
Fax: 972-818-2924

#### Detroit

Farmington Hills, MI  
Tel: 248-538-2250  
Fax: 248-538-2260

#### Kokomo

Kokomo, IN  
Tel: 765-864-8360  
Fax: 765-864-8387

#### Los Angeles

Mission Viejo, CA  
Tel: 949-462-9523  
Fax: 949-462-9608

#### Santa Clara

Santa Clara, CA  
Tel: 408-961-6444  
Fax: 408-961-6445

#### Toronto

Mississauga, Ontario,  
Canada  
Tel: 905-673-0699  
Fax: 905-673-6509

### ASIA/PACIFIC

**Asia Pacific Office**  
Suites 3707-14, 37th Floor  
Tower 6, The Gateway  
Harbour City, Kowloon  
Hong Kong  
Tel: 852-2401-1200  
Fax: 852-2401-3431

**Australia - Sydney**  
Tel: 61-2-9868-6733  
Fax: 61-2-9868-6755

**China - Beijing**  
Tel: 86-10-8528-2100  
Fax: 86-10-8528-2104

**China - Chengdu**  
Tel: 86-28-8665-5511  
Fax: 86-28-8665-7889

**China - Fuzhou**  
Tel: 86-591-8750-3506  
Fax: 86-591-8750-3521

**China - Hong Kong SAR**  
Tel: 852-2401-1200  
Fax: 852-2401-3431

**China - Qingdao**  
Tel: 86-532-8502-7355  
Fax: 86-532-8502-7205

**China - Shanghai**  
Tel: 86-21-5407-5533  
Fax: 86-21-5407-5066

**China - Shenyang**  
Tel: 86-24-2334-2829  
Fax: 86-24-2334-2393

**China - Shenzhen**  
Tel: 86-755-8203-2660  
Fax: 86-755-8203-1760

**China - Shunde**  
Tel: 86-757-2839-5507  
Fax: 86-757-2839-5571

**China - Wuhan**  
Tel: 86-27-5980-5300  
Fax: 86-27-5980-5118

**China - Xian**  
Tel: 86-29-8833-7252  
Fax: 86-29-8833-7256

### ASIA/PACIFIC

**India - Bangalore**  
Tel: 91-80-4182-8400  
Fax: 91-80-4182-8422

**India - New Delhi**  
Tel: 91-11-4160-8631  
Fax: 91-11-4160-8632

**India - Pune**  
Tel: 91-20-2566-1512  
Fax: 91-20-2566-1513

**Japan - Yokohama**  
Tel: 81-45-471- 6166  
Fax: 81-45-471-6122

**Korea - Daegu**  
Tel: 82-53-744-4301  
Fax: 82-53-744-4302

**Korea - Seoul**  
Tel: 82-2-554-7200  
Fax: 82-2-558-5932 or  
82-2-558-5934

**Malaysia - Penang**  
Tel: 60-4-646-8870  
Fax: 60-4-646-5086

**Philippines - Manila**  
Tel: 63-2-634-9065  
Fax: 63-2-634-9069

**Singapore**  
Tel: 65-6334-8870  
Fax: 65-6334-8850

**Taiwan - Hsin Chu**  
Tel: 886-3-572-9526  
Fax: 886-3-572-6459

**Taiwan - Kaohsiung**  
Tel: 886-7-536-4818  
Fax: 886-7-536-4803

**Taiwan - Taipei**  
Tel: 886-2-2500-6610  
Fax: 886-2-2508-0102

**Thailand - Bangkok**  
Tel: 66-2-694-1351  
Fax: 66-2-694-1350

### EUROPE

**Austria - Wels**  
Tel: 43-7242-2244-39  
Fax: 43-7242-2244-393

**Denmark - Copenhagen**  
Tel: 45-4450-2828  
Fax: 45-4485-2829

**France - Paris**  
Tel: 33-1-69-53-63-20  
Fax: 33-1-69-30-90-79

**Germany - Munich**  
Tel: 49-89-627-144-0  
Fax: 49-89-627-144-44

**Italy - Milan**  
Tel: 39-0331-742611  
Fax: 39-0331-466781

**Netherlands - Drunen**  
Tel: 31-416-690399  
Fax: 31-416-690340

**Spain - Madrid**  
Tel: 34-91-708-08-90  
Fax: 34-91-708-08-91

**UK - Wokingham**  
Tel: 44-118-921-5869  
Fax: 44-118-921-5820

06/25/07

Компания «Океан Электроники» предлагает заключение долгосрочных отношений при поставках импортных электронных компонентов на взаимовыгодных условиях!

Наши преимущества:

- Поставка оригинальных импортных электронных компонентов напрямую с производств Америки, Европы и Азии, а так же с крупнейших складов мира;
- Широкая линейка поставок активных и пассивных импортных электронных компонентов (более 30 млн. наименований);
- Поставка сложных, дефицитных, либо снятых с производства позиций;
- Оперативные сроки поставки под заказ (от 5 рабочих дней);
- Экспресс доставка в любую точку России;
- Помощь Конструкторского Отдела и консультации квалифицированных инженеров;
- Техническая поддержка проекта, помощь в подборе аналогов, поставка прототипов;
- Поставка электронных компонентов под контролем ВП;
- Система менеджмента качества сертифицирована по Международному стандарту ISO 9001;
- При необходимости вся продукция военного и аэрокосмического назначения проходит испытания и сертификацию в лаборатории (по согласованию с заказчиком);
- Поставка специализированных компонентов военного и аэрокосмического уровня качества (Xilinx, Altera, Analog Devices, Intersil, Interpoint, Microsemi, Actel, Aeroflex, Peregrine, VPT, Syfer, Eurofarad, Texas Instruments, MS Kennedy, Miteq, Cobham, E2V, MA-COM, Hittite, Mini-Circuits, General Dynamics и др.);

Компания «Океан Электроники» является официальным дистрибьютором и эксклюзивным представителем в России одного из крупнейших производителей разъемов военного и аэрокосмического назначения «JONHON», а так же официальным дистрибьютором и эксклюзивным представителем в России производителя высокотехнологичных и надежных решений для передачи СВЧ сигналов «FORSTAR».



## JONHON

«JONHON» (основан в 1970 г.)

Разъемы специального, военного и аэрокосмического назначения:

(Применяются в военной, авиационной, аэрокосмической, морской, железнодорожной, горно- и нефтедобывающей отраслях промышленности)

«FORSTAR» (основан в 1998 г.)

ВЧ соединители, коаксиальные кабели,  
кабельные сборки и микроволновые компоненты:

(Применяются в телекоммуникациях гражданского и специального назначения, в средствах связи, РЛС, а так же военной, авиационной и аэрокосмической отраслях промышленности).



Телефон: 8 (812) 309-75-97 (многоканальный)

Факс: 8 (812) 320-03-32

Электронная почта: [ocean@oceanchips.ru](mailto:ocean@oceanchips.ru)

Web: <http://oceanchips.ru/>

Адрес: 198099, г. Санкт-Петербург, ул. Калинина, д. 2, корп. 4, лит. А