

---

# Amphenol Pcd

Connecting People & Technology

---

System Attachments



## System Attachments

Designed to secure, guide and manage cable harnesses and pipes through aircraft and vehicles, Amphenol Pcd's System Attachments are engineered with strength, stability and weight reduction in mind. Designed for lean manufacturing, our System Attachments are rugged – able to withstand high vibration and shock, and non-conductive/non-corrosive – able to withstand many harsh environments for the lifetime of the aircraft. Based on the requirement, there are many styles and materials to choose from, and customization is always an option.

# Amphenol Pcd

Connecting People & Technology

[www.amphenolpcd.com](http://www.amphenolpcd.com)

[info@amphenolpcd.com](mailto:info@amphenolpcd.com)

• 978.624.3400 •

## SUPPORT CLAMPS

|                               |   |
|-------------------------------|---|
| High Performance P-Clamps     | 5 |
| High Performance OMEGA Clamps | 6 |
| High Performance LDG P-Clamps | 7 |
| High Performance C-Clamps     | 8 |

---

## WIRING ACCESSORIES

|                         |       |
|-------------------------|-------|
| Hat Supports            | 9     |
| Harness Supports        | 10-12 |
| Cable Supports          | 13-17 |
| Cable Separators        | 18    |
| Lightening Hole Bushing | 19    |
| Conduits                | 20    |

---

## STANDOFFS

|                                  |    |
|----------------------------------|----|
| Standoffs                        | 21 |
| Amphenol Air LB France Standoffs | 22 |

---

## BRACKETS

|                                 |       |
|---------------------------------|-------|
| Amphenol Air LB France Brackets | 23-24 |
|---------------------------------|-------|

## RACEWAYS

|                       |    |
|-----------------------|----|
| Accessories, ABS 2225 | 25 |
|-----------------------|----|

---

## CUSTOM SOLUTIONS

|                                   |    |
|-----------------------------------|----|
| Power Feeder Spacer & CRN Bracket | 26 |
| Fairlead Blocks                   | 27 |
| Jig Board Clamps                  | 28 |





Engineered for lean manufacturing, the high performance P-Clamps were developed to replace and out perform traditional P-Clamps and Saddle Clamps. Featuring an overmold silicone cushion with PEEK polymer, our clamps are completely non-conductive/non-corrosive, lightweight, and very durable.

## Specifications

### Materials:

Plastic (Glass-Reinforced): Polyetheretherketone per MIL-P-46183  
Elastomer protection: Silicone Rubber per ASTM-D-2000

### Temperature Limits:

Operating temperature: -65°F to 350°F (-54°C to +107°C)  
Excursions: Up to 500°F

### Flammability:

UL94, VO; FAR25.853



| Part Number | Size Number | Inner Cushion Diameter (ØD) |      | F    |      | L    |      | H    |      | T    |      | Weight |       |
|-------------|-------------|-----------------------------|------|------|------|------|------|------|------|------|------|--------|-------|
|             |             | Inch                        | mm   | Inch | mm   | Inch | mm   | Inch | mm   | Inch | mm   | Ounces | Grams |
| PCL150101   | 101         | 0.12                        | 3.0  | 0.59 | 15.1 | 1.18 | 29.9 | 0.64 | 16.2 | 0.18 | 4.6  | 0.14   | 4.08  |
| PCL150102   | 102         | 0.22                        | 5.6  | 0.64 | 16.3 | 1.27 | 32.2 | 0.71 | 18.0 | 0.18 | 4.6  | 0.16   | 4.54  |
| PCL150103   | 103         | 0.31                        | 7.9  | 0.71 | 18.1 | 1.41 | 35.9 | 0.81 | 20.6 | 0.24 | 6.1  | 0.22   | 6.35  |
| PCL150104   | 104         | 0.41                        | 10.3 | 0.76 | 19.3 | 1.51 | 38.3 | 0.88 | 22.5 | 0.24 | 6.1  | 0.24   | 6.80  |
| PCL150105   | 105         | 0.50                        | 12.7 | 0.81 | 20.5 | 1.60 | 40.7 | 0.96 | 24.4 | 0.24 | 6.1  | 0.27   | 7.71  |
| PCL150106   | 106         | 0.59                        | 15.1 | 0.85 | 21.7 | 1.70 | 43.2 | 1.05 | 26.8 | 0.24 | 6.1  | 0.29   | 8.16  |
| PCL150107   | 107         | 0.69                        | 17.5 | 0.93 | 23.5 | 1.84 | 46.7 | 1.20 | 30.5 | 0.30 | 7.6  | 0.38   | 10.89 |
| PCL150108   | 108         | 0.78                        | 19.9 | 0.97 | 24.7 | 1.93 | 49.1 | 1.32 | 33.5 | 0.30 | 7.6  | 0.43   | 12.25 |
| PCL150109   | 109         | 0.88                        | 22.2 | 1.02 | 25.9 | 2.03 | 51.5 | 1.39 | 35.3 | 0.30 | 7.6  | 0.45   | 12.70 |
| PCL150110   | 110         | 0.97                        | 24.6 | 1.07 | 27.1 | 2.12 | 53.8 | 1.48 | 37.6 | 0.30 | 7.6  | 0.48   | 13.61 |
| PCL150111   | 111         | 1.06                        | 27.0 | 1.14 | 28.9 | 2.26 | 57.5 | 1.62 | 41.2 | 0.36 | 9.1  | 0.59   | 16.78 |
| PCL150112   | 112         | 1.16                        | 29.4 | 1.18 | 30.1 | 2.36 | 59.9 | 1.76 | 44.7 | 0.36 | 9.1  | 0.64   | 18.14 |
| PCL150113   | 113         | 1.25                        | 31.8 | 1.23 | 31.3 | 2.45 | 62.3 | 1.82 | 46.3 | 0.36 | 9.1  | 0.67   | 19.05 |
| PCL150114   | 114         | 1.34                        | 34.1 | 1.29 | 32.8 | 2.58 | 65.5 | 1.93 | 49.1 | 0.40 | 10.0 | 0.75   | 21.32 |
| PCL150115   | 115         | 1.44                        | 36.5 | 1.35 | 34.3 | 2.69 | 68.3 | 2.05 | 52.0 | 0.42 | 10.7 | 0.85   | 24.04 |

# HIGH PERFORMANCE OMEGA CLAMPS



Engineered for lean manufacturing, the high performance Omega Clamps were developed to replace and out perform traditional P-Clamps and Saddle Clamps. Featuring an overmold silicone cushion with PEEK polymer, our clamps are completely non-conductive/non-corrosive, lightweight, and very durable.

## Specifications

**Materials:**

Plastic (Glass-Reinforced): Polyetheretherketone per MIL-P-46183  
 Elastomer protection: Silicone Rubber per ASTM-D-2000

**Temperature Limits:**

Operating temperature: -65°F to 350°F (-54°C to +107°C)  
 Excursions: Up to 500°F

**Flammability:**

UL94, VO; FAR25.853



| Part Number | Size Number | Inner Cushion Diameter (ØD) |      | F    |      | L    |      | H    |      | E    |     | C    |      | Weight |       |
|-------------|-------------|-----------------------------|------|------|------|------|------|------|------|------|-----|------|------|--------|-------|
|             |             | Inch                        | mm   | Inch | mm   | Inch | mm   | Inch | mm   | Inch | mm  | Inch | mm   | Ounces | Grams |
| PCL250008   | 08          | 0.45                        | 11.4 | 0.78 | 19.8 | 2.19 | 55.6 | 0.91 | 23.1 | 0.20 | 5.1 | 1.56 | 39.6 | 0.32   | 9.07  |
| PCL250010   | 10          | 0.57                        | 14.5 | 0.84 | 21.3 | 2.31 | 58.7 | 1.03 | 26.2 | 0.20 | 5.1 | 1.68 | 42.7 | 0.35   | 9.98  |
| PCL250011   | 11          | 0.63                        | 16.0 | 0.89 | 22.6 | 2.42 | 61.5 | 1.14 | 29.0 | 0.25 | 6.4 | 1.79 | 45.5 | 0.43   | 12.32 |
| PCL250012   | 12          | 0.70                        | 17.8 | 0.93 | 23.6 | 2.49 | 63.2 | 1.21 | 30.7 | 0.25 | 6.4 | 1.86 | 47.2 | 0.46   | 12.94 |
| PCL250013   | 13          | 0.77                        | 19.6 | 0.96 | 24.4 | 2.56 | 65.0 | 1.28 | 32.5 | 0.25 | 6.4 | 1.93 | 49.0 | 0.48   | 13.61 |
| PCL250014   | 14          | 0.83                        | 21.1 | 1.00 | 25.4 | 2.62 | 66.5 | 1.34 | 34.0 | 0.25 | 6.4 | 1.99 | 50.5 | 0.50   | 14.06 |
| PCL250015   | 15          | 0.89                        | 22.6 | 1.03 | 26.2 | 2.68 | 68.1 | 1.40 | 35.6 | 0.25 | 6.4 | 2.05 | 52.1 | 0.53   | 14.95 |
| PCL250016   | 16          | 0.95                        | 24.1 | 1.08 | 27.4 | 2.79 | 70.9 | 1.51 | 38.4 | 0.30 | 7.6 | 2.16 | 54.9 | 0.67   | 19.05 |
| PCL250017   | 17          | 1.01                        | 25.7 | 1.11 | 28.2 | 2.85 | 72.4 | 1.57 | 39.9 | 0.30 | 7.6 | 2.22 | 56.4 | 0.70   | 19.96 |
| PCL250018   | 18          | 1.07                        | 27.2 | 1.14 | 29.0 | 2.91 | 73.9 | 1.63 | 41.4 | 0.30 | 7.6 | 2.28 | 57.9 | 0.72   | 20.41 |
| PCL250019   | 19          | 1.13                        | 28.7 | 1.17 | 29.7 | 2.97 | 75.4 | 1.69 | 42.9 | 0.30 | 7.6 | 2.34 | 59.4 | 0.75   | 21.32 |
| PCL250020   | 20          | 1.20                        | 30.5 | 1.22 | 31.0 | 3.07 | 78.0 | 1.79 | 45.5 | 0.33 | 8.4 | 2.44 | 62.0 | 0.80   | 22.68 |
| PCL250021   | 21          | 1.26                        | 32.0 | 1.24 | 31.5 | 3.10 | 78.7 | 1.82 | 46.2 | 0.30 | 7.6 | 2.47 | 62.7 | 0.80   | 22.68 |
| PCL250022   | 22          | 1.33                        | 33.8 | 1.27 | 32.3 | 3.17 | 80.5 | 1.89 | 48.0 | 0.30 | 7.6 | 2.54 | 64.5 | 0.82   | 23.13 |
| PCL250024   | 24          | 1.45                        | 36.8 | 1.33 | 33.8 | 3.29 | 83.6 | 2.01 | 51.1 | 0.30 | 7.6 | 2.66 | 67.6 | 0.84   | 23.80 |
| PCL250025   | 25          | 1.51                        | 38.4 | 1.36 | 34.5 | 3.35 | 85.1 | 2.07 | 52.6 | 0.30 | 7.6 | 2.72 | 69.1 | 0.90   | 25.40 |
| PCL250026   | 26          | 1.57                        | 39.9 | 1.39 | 35.3 | 3.41 | 86.6 | 2.13 | 54.1 | 0.30 | 7.6 | 2.78 | 70.6 | 0.91   | 25.85 |
| PCL250028   | 28          | 1.70                        | 43.2 | 1.46 | 37.1 | 3.57 | 90.7 | 2.29 | 58.2 | 0.33 | 8.4 | 2.91 | 73.9 | 1.06   | 30.16 |
| PCL250032   | 32          | 1.95                        | 49.5 | 1.58 | 40.2 | 3.82 | 97.0 | 2.54 | 64.5 | 0.33 | 8.4 | 3.16 | 80.3 | 1.17   | 33.11 |



Amphenol Pcd's LDG P-Clamps use a soft rubber for clamp cushioning, thereby reducing wear and tear on mission-critical cable harnesses without compromising the strength and performance of the clamp itself. Specifically designed for high performance aerospace cables, such as the MT/MTL product lines, they are easy to use, simple to maintain, and available in 17 different sizes.

## Specifications

### Materials:

Plastic (Glass-Reinforced): Polyetheretherketone per MIL-P-46183; Black Elastomer protection: Silicone Rubber; 20 durometer Shore A; Light Green

### Temperature Limits:

Operating temperature: -65°F to 350°F (-54°C to +107°C)  
Excursions: Up to 500°F

### Flammability:

Clamp base: UL94, VO; FAR25.853  
Cushion: Meets UL94, HB

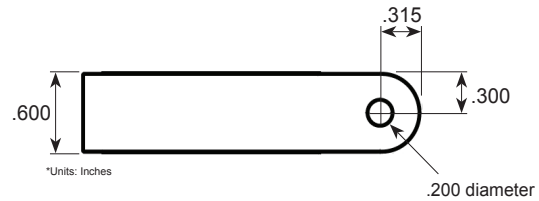

| Part Number | Size Number | Inner Cushion dia. (ØD) |       | MIN. Cable Size |       | MAX. Cable Size |       | F    |      | L    |      | H    |      | T    |      | Weight |       |
|-------------|-------------|-------------------------|-------|-----------------|-------|-----------------|-------|------|------|------|------|------|------|------|------|--------|-------|
|             |             | Inch                    | mm    | Inch            | mm    | Inch            | mm    | Inch | mm   | Inch | mm   | Inch | mm   | Inch | mm   | Ounces | Grams |
| PCL400100   | 100         | 0.030                   | .76   | 0.060           | 1.52  | 0.190           | 4.83  | 0.59 | 15.1 | 1.18 | 29.9 | 0.64 | 16.2 | 0.18 | 4.6  | 0.15   | 4.30  |
| PCL400101   | 101         | 0.125                   | 3.18  | 0.155           | 3.94  | 0.248           | 6.30  | 0.59 | 15.1 | 1.18 | 29.9 | 0.64 | 16.2 | 0.18 | 4.6  | 0.14   | 4.08  |
| PCL400102   | 102         | 0.219                   | 5.56  | 0.249           | 6.32  | 0.342           | 8.69  | 0.64 | 16.3 | 1.27 | 32.2 | 0.71 | 18.0 | 0.18 | 4.6  | 0.16   | 4.54  |
| PCL400103   | 103         | 0.313                   | 7.95  | 0.343           | 8.71  | 0.436           | 11.07 | 0.71 | 18.1 | 1.41 | 35.9 | 0.81 | 20.6 | 0.24 | 6.1  | 0.22   | 6.35  |
| PCL400104   | 104         | 0.407                   | 10.34 | 0.437           | 11.1  | 0.530           | 13.46 | 0.76 | 19.3 | 1.51 | 38.3 | 0.88 | 22.5 | 0.24 | 6.1  | 0.24   | 6.80  |
| PCL400105   | 105         | 0.501                   | 12.73 | 0.531           | 13.49 | 0.623           | 15.82 | 0.81 | 20.5 | 1.60 | 40.7 | 0.96 | 24.4 | 0.24 | 6.1  | 0.27   | 7.71  |
| PCL400106   | 106         | 0.594                   | 15.09 | 0.624           | 15.85 | 0.718           | 18.24 | 0.85 | 21.7 | 1.70 | 43.2 | 1.05 | 26.8 | 0.24 | 6.1  | 0.29   | 8.16  |
| PCL400107   | 107         | 0.689                   | 17.5  | 0.719           | 18.26 | 0.811           | 20.60 | 0.93 | 23.5 | 1.84 | 46.7 | 1.20 | 30.5 | 0.30 | 7.6  | 0.38   | 10.89 |
| PCL400108   | 108         | 0.782                   | 19.86 | 0.812           | 20.62 | 0.905           | 22.99 | 0.97 | 24.7 | 1.93 | 49.1 | 1.32 | 33.5 | 0.30 | 7.6  | 0.43   | 12.25 |
| PCL400109   | 109         | 0.876                   | 22.25 | 0.906           | 23.01 | 0.998           | 25.35 | 1.02 | 25.9 | 2.03 | 51.5 | 1.39 | 35.3 | 0.30 | 7.6  | 0.45   | 12.70 |
| PCL400110   | 110         | 0.969                   | 24.61 | 0.999           | 25.37 | 1.092           | 27.74 | 1.07 | 27.1 | 2.12 | 53.8 | 1.48 | 37.6 | 0.30 | 7.6  | 0.48   | 13.61 |
| PCL400111   | 111         | 1.063                   | 27.00 | 1.093           | 27.76 | 1.186           | 30.12 | 1.14 | 28.9 | 2.26 | 57.5 | 1.62 | 41.2 | 0.36 | 9.1  | 0.59   | 16.78 |
| PCL400112   | 112         | 1.157                   | 29.39 | 1.187           | 30.15 | 1.280           | 32.51 | 1.18 | 30.1 | 2.36 | 59.9 | 1.76 | 44.7 | 0.36 | 9.1  | 0.64   | 18.14 |
| PCL400113   | 113         | 1.251                   | 31.78 | 1.281           | 32.54 | 1.373           | 34.87 | 1.23 | 31.3 | 2.45 | 62.3 | 1.82 | 46.3 | 0.36 | 9.1  | 0.67   | 19.05 |
| PCL400114   | 114         | 1.344                   | 34.14 | 1.374           | 34.9  | 1.467           | 37.26 | 1.29 | 32.8 | 2.58 | 65.5 | 1.93 | 49.1 | 0.40 | 10.0 | 0.75   | 21.32 |
| PCL400115   | 115         | 1.438                   | 36.53 | 1.468           | 37.29 | 1.561           | 39.65 | 1.35 | 34.3 | 2.69 | 68.3 | 2.05 | 52.0 | 0.42 | 10.7 | 0.85   | 24.04 |
| PCL400116   | 116         | 1.532                   | 38.91 | 1.562           | 39.67 | 1.655           | 42.04 | 1.39 | 35.3 | 2.78 | 70.6 | 2.14 | 54.3 | 0.42 | 10.7 | 0.92   | 26.04 |

# HIGH PERFORMANCE C-CLAMPS

Amphenol Pcd's C-Clamps (Cable Clamps) provide routing, support and fixing for cable harnesses of various diameters. They are used in the wing sections of aircrafts, in the fuselage for power and electrical cables, as well as inside the cabin for in-flight entertainment or cabin service systems. Different materials and configurations are available depending on the temperature and routing of the conduits (including versions for use inside the fuel tank).

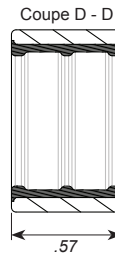
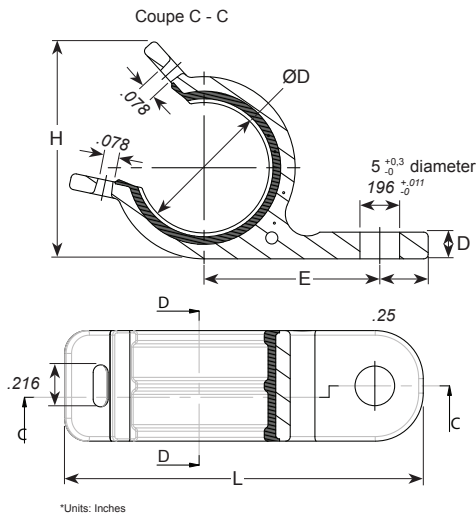

## Specifications

**Materials:**

- Plastic: Black Polyamide
- Elastomer protection: Brown Silicon or Blue Fluorosilicone

**Temperature Limits:**

Operating temperature: -65°F to 350°F (-54°C to +107°C)

**Flammability:**

Conforms to ABD031 standard

**Fluid Resistance:**

Brown version: NATO F44, AS 1241, MIL PRF 680 (type 1), 5606,7870, 23699, 87937 (diluted), 87252 and AMS1428  
 Blue version: Resistant in complete immersion during 96h

| AALBF PN      | Cushion Color | Size | Diameter (ØD) | E (Inch) | L (Inch) | H (Inch) | D (Inch) | Weight |
|---------------|---------------|------|---------------|----------|----------|----------|----------|--------|
|               |               |      |               |          |          |          |          | Grams  |
| 003262 101 00 | Brown         | 01   | 0.2-0.28      | 0.67     | 1.37     | 0.61     | .14      | 2.1    |
| 003262 111 00 | Blue          |      |               |          |          |          |          |        |
| 003262 102 00 | Brown         | 02   | 0.28-0.4      | 0.73     | 1.49     | 0.74     | .14      | 2.5    |
| 003262 112 00 | Blue          |      |               |          |          |          |          |        |
| 003262 103 00 | Brown         | 03   | 0.4-0.55      | 0.80     | 1.63     | 0.91     | .14      | 3.2    |
| 003262 113 00 | Blue          |      |               |          |          |          |          |        |
| 003262 104 00 | Brown         | 04   | 0.55-0.77     | 0.91     | 1.87     | 1.14     | .14      | 4.0    |
| 003262 114 00 | Blue          |      |               |          |          |          |          |        |
| 003262 105 00 | Brown         | 05   | 0.77-1.05     | 1.05     | 2.14     | 1.42     | .14      | 5.3    |
| 003262 115 00 | Blue          |      |               |          |          |          |          |        |
| 003262 106 00 | Brown         | 06   | 1.05-1.38     | 1.22     | 2.47     | 1.77     | .23      | 8.3    |
| 003262 116 00 | Blue          |      |               |          |          |          |          |        |
| 003262 107 00 | Brown         | 07   | 1.38-1.77     | 1.42     | 2.85     | 2.16     | .33      | 11.5   |
| 003262 117 00 | Blue          |      |               |          |          |          |          |        |
| 003262 108 00 | Brown         | 08   | 1.55-1.88     | 1.57     | 2.86     | 2.50     | .32      | 14.6   |
| 003262 118 00 | Blue          |      |               |          |          |          |          |        |

## Specifications

**Materials:**

Nylon per ASTM-D-4066 PA0121  
 Elastomer protection: Brown Silicon or Blue Fluorosilicone

**Temperature Limits:**

Long-term exposure: 167°F (75°C)  
 Short-term exposure: 248°F (120°C)

**Flammability:**

FAR 25.853

Designed to secure and guide wire bundles throughout an aircraft, Amphenol Pcd's Harness and Hat Supports were designed for lean manufacturing and durability. Built in a one-piece, lightweight design with multiple fixing points, the high performance products are strong, durable and make wire bundle installation and maintenance easy. They are able to support large bundles and high stress requirements.

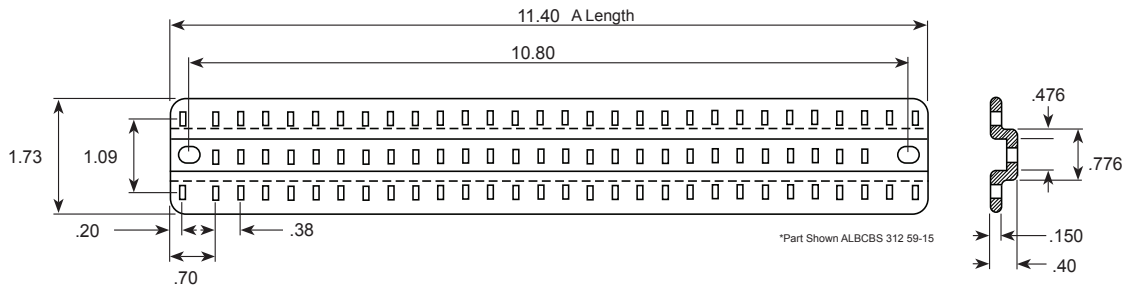

| Part Number      | A Length<br>(* .040 inch) | Weight<br>(g) |
|------------------|---------------------------|---------------|
| ALBCBS 312 59-01 | 8.90                      | 45.8          |
| ALBCBS 312 59-02 | 9.15                      | 47.1          |
| ALBCBS 312 59-03 | 9.90                      | 50.9          |
| ALBCBS 312 59-04 | 5.40                      | 27.8          |
| ALBCBS 312 59-05 | 8.40                      | 43.2          |
| ALBCBS 312 59-06 | 9.53                      | 49.0          |
| ALBCBS 312 59-07 | 8.00                      | 41.2          |
| ALBCBS 312 59-08 | 7.65                      | 39.4          |
| ALBCBS 312 59-09 | 6.90                      | 35.5          |
| ALBCBS 312 59-10 | 6.10                      | 31.4          |
| ALBCBS 312 59-11 | 12.90                     | 66.4          |
| ALBCBS 312 59-12 | 8.10                      | 41.7          |
| ALBCBS 312 59-13 | 7.70                      | 39.6          |
| ALBCBS 312 59-14 | 12.78                     | 65.7          |
| ALBCBS 312 59-15 | 11.40                     | 58.6          |
| ALBCBS 312 59-16 | 6.90                      | 35.5          |
| ALBCBS 312 59-17 | 4.54                      | 23.4          |
| ALBCBS 312 59-18 | 8.40                      | 43.2          |
| ALBCBS 312 59-19 | 7.19                      | 37.0          |
| ALBCBS 312 59-21 | 10.40                     | 53.5          |
| ALBCBS 312 59-23 | 11.30                     | 58.1          |
| ALBCBS 312 59-25 | 7.38                      | 38.0          |
| ALBCBS 312 59-27 | 6.20                      | 31.9          |
| ALBCBS 312 59-29 | 9.37                      | 48.2          |
| ALBCBS 312 59-31 | 8.10                      | 41.7          |
| ALBCBS 312 59-35 | 6.40                      | 32.9          |





| Part Number      | A Length (Inch) | Maximum Weight (g) | Fixing Points |
|------------------|-----------------|--------------------|---------------|
| ALBCBS 303 59-1  | 1.30            | 1.08               | 1             |
| ALBCBS 303 59-3  | 2.30            | 1.86               | 2             |
| ALBCBS 303 59-5  | 3.30            | 2.63               | 3             |
| ALBCBS 303 59-7  | 4.30            | 3.90               | 4             |
| ALBCBS 303 59-9  | 5.30            | 4.17               | 5             |
| ALBCBS 303 59-11 | 6.30            | 4.99               | 6             |
| ALBCBS 303 59-13 | 7.30            | 5.80               | 7             |
| ALBCBS 303 59-15 | 8.30            | 6.58               | 8             |
| ALBCBS 303 59-17 | 9.30            | 7.39               | 9             |
| ALBCBS 303 59-19 | 10.30           | 8.16               | 10            |
| ALBCBS 303 59-21 | 11.30           | 8.98               | 11            |
| ALBCBS 303 59-23 | 12.30           | 9.80               | 12            |

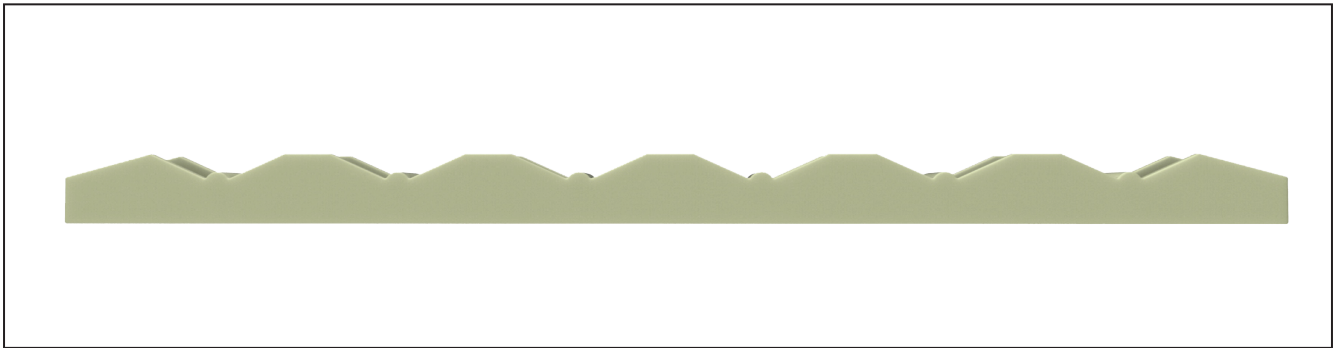

| Part Number      | A Length (Inch) | Maximum Weight (g) | E Fixing (Inch) | @ Fixing Points |
|------------------|-----------------|--------------------|-----------------|-----------------|
| ALBCBS 020 59-11 | 13.05           | 72.6               | 11.59           | 8               |
| ALBCBS 020 59-13 | 11.55           | 63.5               | 10.09           | 7               |
| ALBCBS 020 59-15 | 10.05           | 54.4               | 8.59            | 6               |
| ALBCBS 020 59-17 | 8.55            | 45.4               | 7.09            | 5               |
| ALBCBS 020 59-19 | 7.05            | 36.3               | 5.59            | 4               |



| Part Number      | A Length (Inch) | Maximum Weight (g) | E Fixing (Inch) | <sup>a</sup> Fixing Points |
|------------------|-----------------|--------------------|-----------------|----------------------------|
| ALBCBS 030 59-21 | 13.05           | 59.0               | 11.59           | 15                         |
| ALBCBS 030 59-23 | 11.55           | 49.9               | 10.09           | 13                         |
| ALBCBS 030 59-25 | 10.05           | 45.4               | 8.59            | 11                         |
| ALBCBS 030 59-27 | 8.55            | 36.3               | 7.09            | 9                          |
| ALBCBS 030 59-29 | 7.05            | 27.3               | 5.59            | 7                          |



## Specifications

**Materials:**

Nylon per ASTM-D-4066 PA0121  
 Elastomer protection: Brown Silicon or Blue Fluorosilicone

**Environment:**

Operating temperature: -67°F to +275°F  
 (-55°C to +135°C)

**Flammability:**

To meet FAR 25.853 amtd 25-853 (a) and ADB031

**Fluid Resistance:**

ASTM D 543, MIL-T-81533, TT-T-266, TT-M-261, ASTM D 1635,  
 MIL-T-5624, MIL-T-83133

Amphenol Pcd's Cable Supports are made to fix on an aircraft's airframe, helping to secure and manage cable harnesses as they run throughout the aircraft body. They are offered in nylon and are designed for use in airframe, fuel tank, and engine applications. Available in various standard configurations and sizes, Amphenol Pcd also offers customized products to help meet specific customer requirements.



## Application

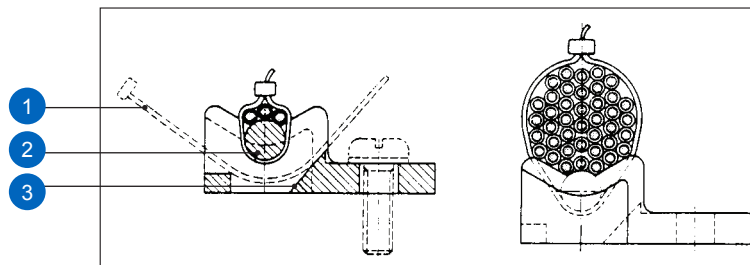







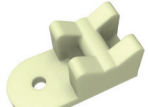
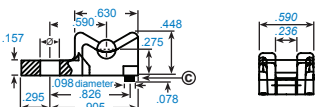
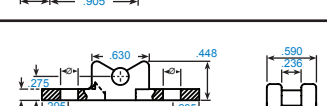

- 1 Cable tie
- 2 Cylindrical support: guides the cables, ensures optimal fixing
- 3 Ramp: to ease quick feed-in of cable tie

## User Warning

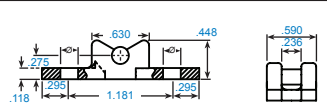
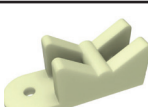
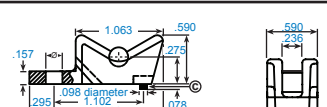
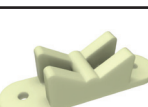
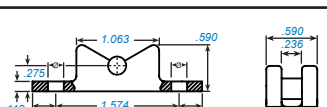
- Eliminates any dehydration agent in storage.
- If the piece regains its humidity, this may cause a coloration of the material.
- Surface coloration does not affect technical properties of the material.
- Wiring accessories conform to ROHS and REACH requirements.

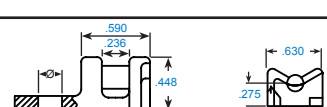
## STRAIGHT SUPPORTS

### Single

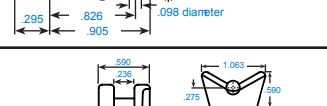
|   | Ø Wiring Minimum-Maximum (Inch) | Part Number Without Block (C) | Part Number With Block (C) | Weight (g) | Hole Ø (Inch) |  |
|---|---------------------------------|-------------------------------|----------------------------|------------|---------------|--|
|    | 0.08-0.59                       | 003261 100 59                 | 003261 150 59              | 2.2        | 0.2           |    |
|   |                                 | 003261 200 59                 | 003261 250 59              | 2.2        | 0.13          |    |
|    | 0.08-0.59                       | ALBCBS 001 05                 | -                          | 3          | 0.13          |    |
|    |                                 | 003261 102 59                 | 003261 152 59              | 2.2        | 0.2           |    |
|   | 003261 202 59                   | 003261 252 59                 | 0.13                       |            |               |  |
|    | 0.08-1.18                       | 003261 127 59                 | -                          | 4.5        | 0.2           |    |
|   |                                 | 003261 227 59                 | -                          |            | 0.13          |  |
|   |                                 | ALBCBS 001 06                 | -                          |            |               |  |
|   | 0.08-0.59                       | 003261 114 59                 | 003261 164 59              | 2.2        | 0.2           |   |
|   |                                 | 003261 113 59                 | 003261 163 59              |            | 0.13          |  |
|  | 0.08-1.18                       | 003261 118 59                 | 003261 168 59              | 3.2        | 0.2           |  |
|   |                                 | 003461 117 59                 | 003261 167 59              |            | 0.13          |  |
|  | 0.08-0.59                       | 003261 173 59                 | -                          | 3          | 0.13          |  |
|   |                                 | 003261 203 59                 | -                          | 4.2        | 0.13          |  |

### Double

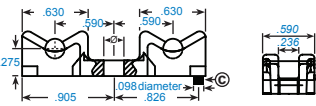
|   | Ø Wiring Minimum-Maximum (Inch) | Part Number Without Block (C) | Part Number With Block (C) | Weight (g) | Hole Ø (Inch) |  |
|---|---------------------------------|-------------------------------|----------------------------|------------|---------------|--|
|  | 0.08-0.59                       | 003261 101 59                 | 003261 151 59              | 3.7        | 0.2           |  |
|   |                                 | 003261 201 59                 | 003261 251 59              |            | 0.13          |  |

## ANGLED SUPPORTS

### Single

|  | Part Number   | Ø Wiring Minimum-Maximum (Inch) | Weight (g) | Hole Ø (Inch) | X (Inch) |  |
|--|---------------|---------------------------------|------------|---------------|----------|--|
|  | 003261 501 59 | 0.08-0.59                       | 3.64       | .125          | -        |  |
|  | 003261 511 59 |                                 | 3.62       | .137          | -        |  |
|  | 003261 115 59 | 0.08-0.59                       | 1.7        | 0.13          | -        |  |
|  | 003261 116 59 | 0.08-1.18                       | 2.4        |               | -        |  |
|  | 003261 111 59 | 0.08-0.59                       | 1.8        | .129          | .724     |  |
|  | 003261 109 59 |                                 | 2          |               | .941     |  |
|  | 003261 131 59 |                                 | 1.8        |               | .767     |  |
|  | 003261 129 59 |                                 | 2          |               | .984     |  |
|  | 003261 121 59 |                                 | 1.8        |               | .767     |  |
|  | 003261 119 59 |                                 | 2          |               | .984     |  |
|  | 003261 210 59 | 0.08-1.18                       | 3          | .129          | .866     |  |
|  | 003261 110 59 |                                 | 3.3        |               | 1.102    |  |
|  | 003261 230 59 |                                 | 3          |               | .866     |  |
|  | 003261 130 59 |                                 | 3.3        |               | 1.102    |  |
|  | 003261 220 59 |                                 | 3          |               | .866     |  |
|  | 003261 120 59 |                                 | 3.3        |               | 1.102    |  |

## ANGLED SUPPORTS

### Double

|  | Part Number   | Ø Wiring Minimum-Maximum (Inch) | Weight (g) | Hole Ø (Inch) |  |
|--|---------------|---------------------------------|------------|---------------|--|
|  | 003261 503 59 | 0.08-1.18                       | 6.14       | .125          |  |
|  | 003261 513 59 |                                 | 6.13       | .137          |  |
|  | 003261 515 59 | 0.08-0.787                      | 6.10       | 0.14          |  |
|  | 003261 502 59 | 0.08-0.59                       | 4.92       | .125          |  |
|  | 003261 512 59 |                                 | 4.9        | .137          |  |

### Heavy Duty Supports

|  | Part Number   | Ø Wiring Minimum-Maximum (Inch) | Weight (g) | Hole Ø (Inch) |  |
|--|---------------|---------------------------------|------------|---------------|--|
|  | ALBCBS 308 59 | 0.08-0.59                       | 8.17       | 0.129         |  |



## STRINGER SUPPORTS FOR SPECIFIC APPLICATIONS

|  | Part Number      | Ø Wiring Minimum-Maximum (Inch) | Weight (g) | Hole Ø (Inch) |  |
|--|------------------|---------------------------------|------------|---------------|--|
|  | ALBCBS 307 59 01 | 0.08-0.59                       | 3.63       | 0.129         |  |
|  | ALBCBS 307 59 02 |                                 |            |               |  |

## STRINGER SUPPORTS

### Clamping Supports

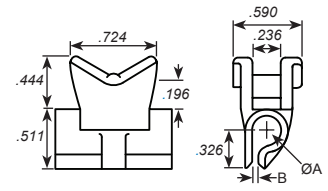
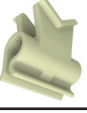
|   | Part Number      | Ø Wiring Minimum-Maximum (Inch) | Weight (g) |   |
|---|------------------|---------------------------------|------------|---|
|  | ALBCBS 310 59-01 | 0.08-0.59                       | 3.4        |  |
|  | ALBCBS 310 59-02 |                                 |            |  |

|   | Part Number      | Ø Wiring Minimum-Maximum (Inch) | Color | Weight (g) | Ø A (Inch) | B (Inch) |  |
|---|------------------|---------------------------------|-------|------------|------------|----------|--|
|    | ALBCBS 304 59-01 | 0.08-0.59                       | Green | 2.86       | 0.200      | 0.2      |  |
|   | ALBCBS 304 59-03 |                                 | White | 2.99       | 0.250      | 0.13     |  |
|  | ALBCBS 304 59-07 |                                 | Grey  | 3.44       | 0.280      |          |  |

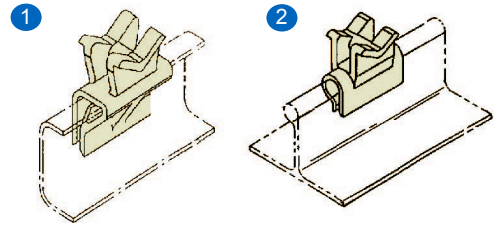

- 1 Angled Support
- 2 Straight Support

# CABLE SEPARATORS



Amphenol Pcd's Cable Separators are used to help separate cable harnesses from one another, aiding in organizing cable routing throughout the aircraft. Available in either Nylon or PEEK, they maintain clearance between two parallel or crossing cable harnesses preventing wire abrasion. Nine different versions are available and they are qualified to Airbus standard ABS1144.



| Air LB P/N    | Airbus P/N  | Number of Parts |        |        |        |        | Max Bundle Diameter (Inch) | Length (Inch) | Weight (+/- 10%) (g) |
|---------------|-------------|-----------------|--------|--------|--------|--------|----------------------------|---------------|----------------------|
|               |             | Head 1          | Head 2 | Tube 1 | Tube 2 | Tube 3 |                            |               |                      |
| 3308 8301 000 | ABS1144A25A | 2               | -      | 1      | -      | -      | 0.63                       | 0.98          | 4.65                 |
| 3308 8302 000 | ABS1144A50A | 2               | -      | -      | 1      | -      |                            | 1.97          | 6.33                 |
| 3308 8303 000 | ABS1144A75A | 2               | -      | -      | -      | 1      |                            | 2.95          | 7.81                 |
| 3308 8304 000 | ABS1144B25A | -               | 2      | 1      | -      | -      | 1.77                       | 0.98          | 6.96                 |
| 3308 8305 000 | ABS1144B50A | -               | 2      | -      | 1      | -      |                            | 1.97          | 8.63                 |
| 3308 8306 000 | ABS1144B75A | -               | 2      | -      | -      | 1      |                            | 2.95          | 10.11                |
| 3308 8307 000 | ABS1144C25A | 1               | 1      | 1      | -      | -      | 1.77                       | 0.98          | 5.81                 |
| 3308 8308 000 | ABS1144C50A | 1               | 1      | -      | 1      | -      |                            | 1.97          | 7.48                 |
| 3308 8309 000 | ABS1144C75A | 1               | 1      | -      | -      | 1      |                            | 2.95          | 8.96                 |

| Amphenol P/N  | Ø D (Inch) | Weight (g) | Color   |
|---------------|------------|------------|---------|
| ALBCBS 350-0A | 0.76       | 0.18       | White   |
| ALBCBS 351-0A | 0.85       | 0.18       | Blue    |
| ALBCBS 352-0A | 1.10       | 0.18       | Yellow  |
| ALBCBS 353-0A | 1.39       | 0.17       | Natural |
| ALBCBS 360-05 | 1.33       | 0.13       | Yellow  |
| ALBCBS 360-06 | 1.77       | 0.13       | White   |
| ALBCBS 360-07 | 1.49       | 0.25       | Blue    |
| ALBCBS 360-08 | 0.99       | 0.18       | Green   |
| ALBCBS 360-10 | 1.36       | 0.25       | Green   |
| ALBCBS 360-11 | 1.35       | 0.18       | Black   |
| ALBCBS 360-12 | 1.49       | 0.18       | Green   |
| ALBCBS 360-13 | 1.38       | 0.16       | White   |
| ALBCBS 360-14 | 0.98       | 0.04       | Black   |
| ALBCBS 360-15 | 1.23       | 0.04       | Blue    |
| ALBCBS 360-17 | 1.48       | 0.06       | Yellow  |
| ALBCBS 360-19 | 0.79       | 0.06       | White   |
| ALBCBS 360-21 | 0.79       | 0.10       | Green   |
| ALBCBS 360-25 | 0.76       | 0.04       | Black   |
| ALBCBS 360-26 | 0.88       | 0.04       | Natural |
| ALBCBS 360-27 | 0.88       | 0.01       | Yellow  |
| ALBCBS 361-01 | 0.98       | 0.035      | Natural |
| ALBCBS 365-01 | 1.50       | 0.05       | Natural |
| ALBCBS 366-01 | 1.50       | 0.02       | Natural |

Additional sizes available upon request

Amphenol Pcd's QuickSNAP Lightening Bushings are made to help guide wired bundles through the aircraft's frame and stringers. Unlike traditional lightening bushings, our products significantly reduce installation times and reduce the amount of foreign object debris (FOD). The lightweight QuickSNAP's are made with smooth edges in order to reduce wire chaffing, and although they are available in various standard configurations and sizes, customization is always an option.

## Specifications

**Materials:**

Nylon per ASTM-D-4066 PA0121

Elastomer protection: Brown Silicon or Blue Fluorosilicone

**Environment:**

Operating temperature: -67°F to 302°F (-55°C to 150°C)

**Flammability:**

FAR 25.853



### Traditional Lightening Hole Bushing



**15 Minutes to Install**

*6 part installation*

- 3 Rivets
- 1 Nylon part
- 1 Caterpillar
- 1 Sheet Metal part

### QuickSNAP Lightening Hole Bushing



**15 Seconds to Install**

*1 part installation*

- 1 Amphenol QuickSNAP Lightening Hole Bushing



Our high performance Conduits are intended to be supported by Amphenol Pcd P-Clamps. Conduits provide support for wire bundles where separation or protection from other systems or structures is necessary. Conduits can be installed anywhere in the aircraft, including the wings. Although Amphenol Pcd Conduits are available in various standard configurations and sizes, we offer custom products as well.



| Amphenol P/N  | DIM "A" | Ø B (Inch) |
|---------------|---------|------------|
| ALBFTD 002-00 | 5.50    | 1.06       |
| ALBFTD 003-00 | 7.25    | 1.06       |
| ALBFTD 004-00 | 5.50    | 0.38       |
| ALBFTD 005-00 | 7.25    | 0.69       |
| ALBFTD 007-00 | 7.63    | 0.38       |
| ALBFTD 008-00 | 5.50    | 0.51       |
| ALBFTD 009-00 | 8.00    | 0.44       |

TOLERANCES: .XX ± .03, ±.XXX .010

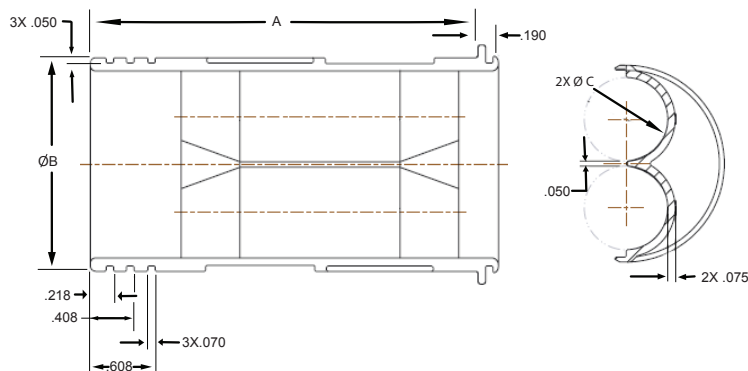

| Amphenol P/N  | DIM "A" | Ø B (Inch) | Ø C (Inch) |
|---------------|---------|------------|------------|
| ALBFTD 001-00 | 0.50    | 1.85       | 0.375      |
| ALBFTD 006-00 | 1.25    | 2.81       | 0.625      |

TOLERANCES: .XX ± .03, ±.XXX .010



## Specifications

**Materials:**

Glass-Reinforced PEEK Per MIL-P-46183 with metallic threaded insert

**Environment:**

Operating temperature: -67°F to +266°F (-55°C to +130°C)

**Flammability:**

UL94, VO; FAR25.853

Made to help guide wire bundles through the aircraft, Amphenol Pcd's High Performance Standoffs are very strong, durable, and lightweight. Our Standoffs are made with glass-reinforced PEEK a very robust, non-conductive/non-corrosive, and lightweight material with excellent chemical resistance. They come with a locking feature for security, are designed with ribs to provide additional strength, and support a wide range of clamp sizes and harness supports for added convenience.



## 90 Degree

| Amphenol P/N  | A Length (Inch) | B Thickness (Inch) |
|---------------|-----------------|--------------------|
| ALBSTO 002-02 | 0.54            | 0.16               |
| ALBSTO 002-04 | 0.74            |                    |
| ALBSTO 002-06 | 0.94            |                    |
| ALBSTO 002-08 | 1.14            |                    |
| ALBSTO 003-10 | 1.34            |                    |
| ALBSTO 003-12 | 1.54            | 0.175              |
| ALBSTO 003-14 | 1.74            |                    |
| ALBSTO 003-16 | 1.94            |                    |
| ALBSTO 003-18 | 2.14            |                    |
| ALBSTO 003-20 | 2.34            |                    |
| ALBSTO 003-22 | 2.54            |                    |
| ALBSTO 003-24 | 2.74            |                    |



## Straight

| Amphenol P/N  | A Height (Inch) |
|---------------|-----------------|
| ALBSTO 051-03 | 0.30            |
| ALBSTO 051-04 | 0.40            |
| ALBSTO 051-06 | 0.60            |
| ALBSTO 051-08 | 0.80            |
| ALBSTO 051-10 | 1.00            |
| ALBSTO 051-12 | 1.20            |
| ALBSTO 051-14 | 1.40            |
| ALBSTO 051-16 | 1.60            |
| ALBSTO 051-18 | 1.80            |
| ALBSTO 051-20 | 2.00            |

## Specifications

### Materials:

Black thermoplastic with metallic threaded insert

### Environment:

Operating temperature : Type 1: -67°F to +266°F (-55°C to +130°C)  
Type 2: -67°F to +185°F (-55°C to +85°C)

### Flammability:

Conform to ABD031 standard

### Fluid Resistance:

NATO F44, AS 1241, MIL PRF 680 (type 1), 5606, 7870, 23699, 87937 (diluted), 87252 and ASM 1428



## Support Type I

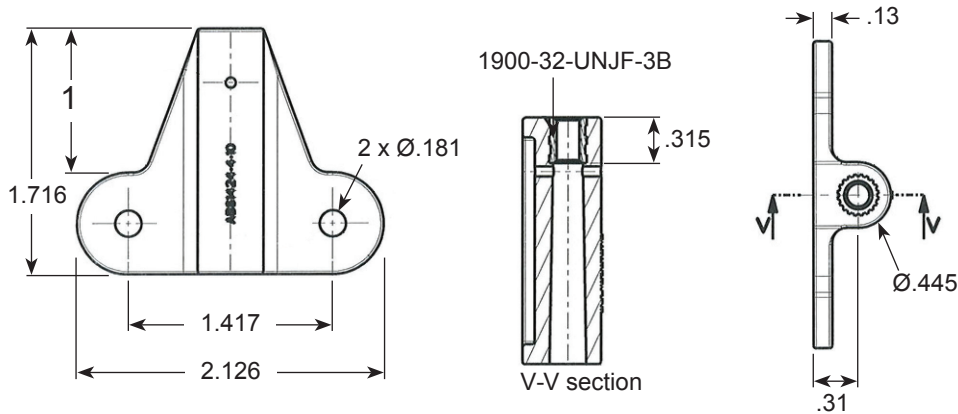

|              |               |
|--------------|---------------|
| Type         | 1             |
| Amphenol P/N | 3450 0031 313 |
| Weight (g)   | 14            |



## Support Type II

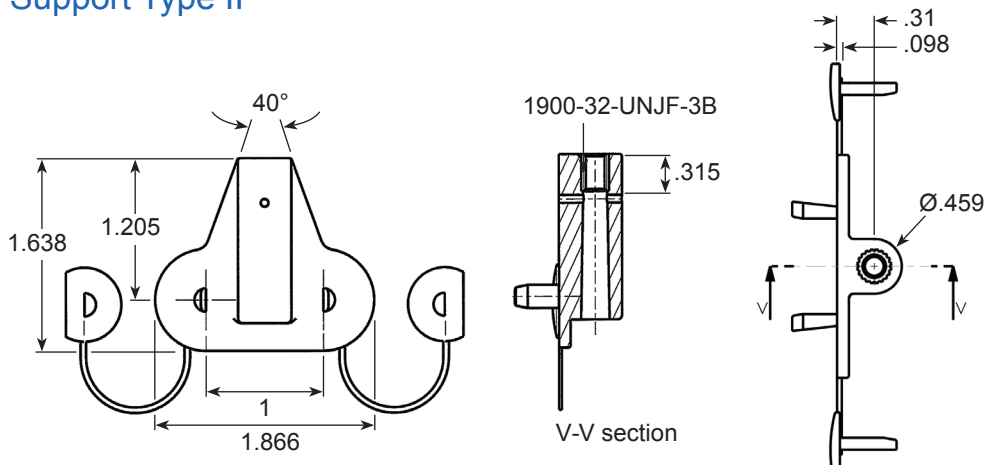

|              |               |
|--------------|---------------|
| Type         | 2             |
| Amphenol P/N | 3540 0034 356 |
| Weight (g)   | 9.2           |



## ABS 1694

### Specifications

**Materials:**

Black thermoplastic  
Shocks: RTCA/DO-160G cat. E

**Environment:**

Operating temperature: -67°F to +185°F (-55°C to +85°C)

**Flammability:**

Conform to ABD031 standard

**Fluid Resistance:**

N, O, P and R types: NATO F44, AS 1241, MIL PRF 680 (type 1), 5606, 7870, 23699, 87937 (diluted), 87252 and AMS 1428  
S type: Resistant in complete immersion during 24h

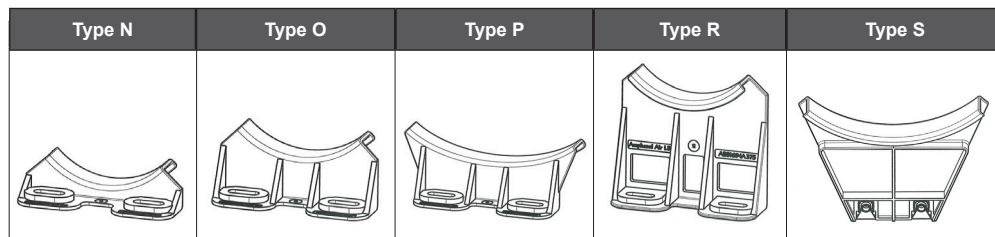

\*ABS 1694 & 1695 conform to ROHS and REACH Requirements

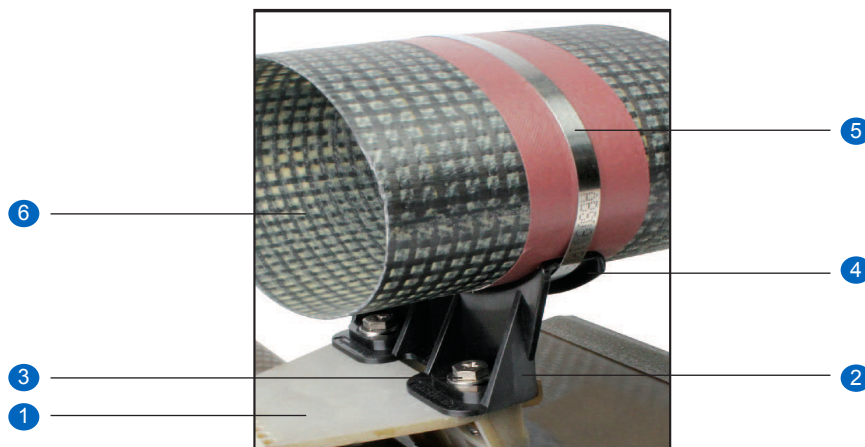

- 1 Panel
- 2 ABS1694 fixing system
- 3 Panel mounting system (screw + washer not supplied)
- 4 Spout for ring clamp
- 5 Ring clamp
- 6 Pipe clamp

## ABS 1695

### Specifications

**Materials:**

Black thermoplastic

**Environment:**

Operating temperature: -67°F to +185°F (-55°C to +85°C)

**Flammability:**

Conform to ABD031 standard

**Fluid Resistance:**

NATO F44, AS 1241, MIL PRF 680 (type 1), 5606,7870, 23699, 87937 (diluted), 87252 and ASM 1428

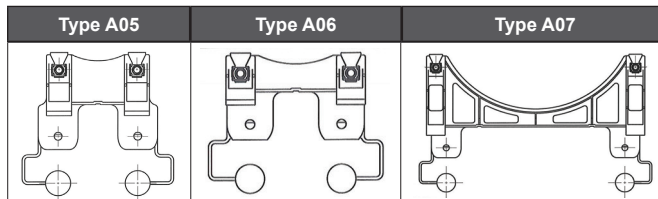

\*ABS 1694 & 1695 conform to ROHS and REACH Requirements

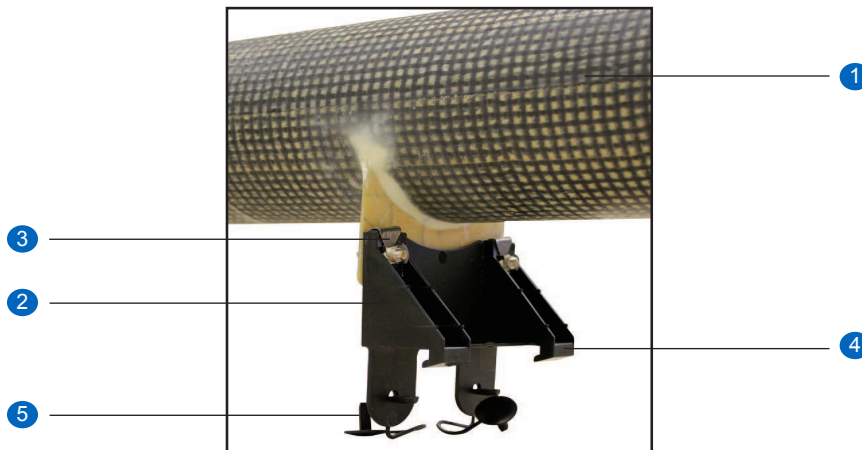

- ① Pipe Clamp
- ② ABS1695 fixing system
- ③ Fixing system for pipe clamps (screw and nut not supplied)
- ④ ABS 1339 cable clamp
- ⑤ Locking system for fixing system on panel with integrated locking pin

# ACCESSORIES, ABS 2225

## Specifications

**Materials:**

Black thermoplastic

**Environment:**

Operating temperature: -67°F to +185°F (-55°C to +85°C)

**Flammability:**

Conform to ABD031 standard

**Fluid Resistance:**

NATO F44, AS 1241, Mil PRF 680 (type 1), 5606, 7870, 23699, 87937 (diluted), 87252 and ASM 1428

This accessory is a bar of various lengths which allows the user to fix Cable Clamps ABS1339 on up to three sides. The adapter on each end of the bar allows the user to select the desired position for the panel mounting 0°, 90°, 180°, 270°.

## ABS 2225 Systems- Adapter



| AALBF P/N     | Weight (g) | A (Inch) | B (Inch) | C (Inch) |
|---------------|------------|----------|----------|----------|
| 3540 0131 000 | 11.7       | .591     | 1.142    | 1.378    |
| 3540 0132 000 | 13.2       | .945     | 1.496    | 1.732    |
| 3540 0133 000 | 14.7       | 1.299    | 1.850    | 2.086    |

## Pin for ABS 2225 Body



| AALBF P/N         | Weight (g) |
|-------------------|------------|
| 3540 0042 356 SCS | 11.7       |



| AALBF P/N     | H (Inch) | L (Inch) | Weight (g) |
|---------------|----------|----------|------------|
| 3540 8201 000 | -        | 1.279    | 11         |
| 3540 8202 000 | .984     | 2.264    | 17         |
| 3540 8203 000 | 1.968    | 3.248    | 23         |
| 3540 8204 000 | 2.953    | 4.232    | 29         |
| 3540 8205 000 | 3.937    | 5.216    | 34         |
| 3540 8206 000 | 4.921    | 6.200    | 39         |
| 3540 8207 000 | 5.905    | 7.185    | 46         |
| 3540 8208 000 | 6.889    | 8.169    | 52         |
| 3540 8209 000 | 7.874    | 9.153    | 58         |
| 3540 8210 000 | 8.858    | 10.137   | 63         |
| 3540 8211 000 | 9.842    | 11.122   | 69         |
| 3540 8212 000 | 10.826   | 12.106   | 75         |
| 3540 8213 000 | 11.811   | 13.090   | 81         |
| 3540 8214 000 | 12.795   | 14.074   | 87         |
| 3540 8215 000 | 13.779   | 15.059   | 93         |
| 3540 8216 000 | 14.763   | 16.043   | 98         |
| 3540 8217 000 | 15.747   | 17.027   | 104        |
| 3540 8218 000 | 16.732   | 18.011   | 110        |
| 3540 8219 000 | 17.716   | 18.995   | 116        |
| 3540 8220 000 | 18.700   | 19.980   | 122        |
| 3540 8221 000 | 19.684   | 20.964   | 127        |
| 3540 8222 000 | 20.669   | 21.948   | 133        |
| 3540 8223 000 | 21.653   | 22.932   | 140        |
| 3540 8224 000 | 22.637   | 23.917   | 145        |



# POWER FEEDER SPACER & CRN BRACKET

## Power Feeder Spacer

Power Feeder Spacers provide a constant spacing between the power feeder. The custom design of this product allows a six degree rotation on the power feeder bundle and doesn't fight against the natural flow of the cable. It is designed to sit within Omega Clamps used as anchor points.



## CRN Bracket

The CRN Bracket is custom made to hold the "Current Return Network" in place inside a composite aircraft. Very easy to install with a bolt, the CRN system is fixed in place by hand with an integrated snap system on the bracket. The bracket is made of PEEK material, and silicone is compression overmolded onto the bracket.



Designed to ensure that pipes and tubes are properly secured throughout their entire length, Amphenol Pcd's Fairlead Blocks provide stability against surges and vibration and are available in multiple materials depending on required chemical environment. Our blocks accommodate a wide range of tube diameters and the products can be supplied with all-captive components, eliminating loose parts and potential FOD.

## Specifications

- High Performance Materials: Strong, Durable & Lightweight
- All-Captive Components: Lean manufacturing; reduces costs
- Design & Engineering: Prevents wire and tube chaffing; protects against surges and harsh vibration
- Fairlead blocks are custom-built to order. Contact Amphenol Pcd with required dimensions

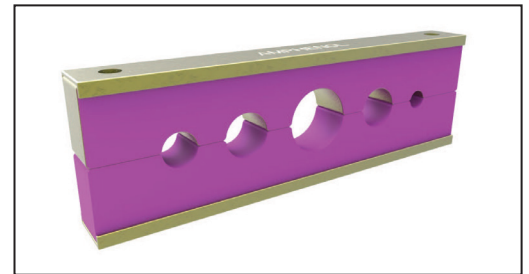
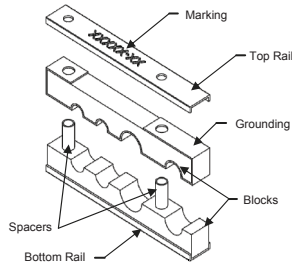

| Rails/Spacers Specifications      |   |                  |
|-----------------------------------|---|------------------|
| Materials                         | Coating   | Application      |
| Aluminum Alloy 6061-T6 or 2024-T3 | Chemical Conversion Coating per MIL-C-5541 Class 1A   | Light Duty       |
| Stainless Steel per ASTM A109     | Cadmium Plate per QQ-P416, TYPE II Class I            | High Performance |
| Carbon Fiber Composite            | Contact Amphenol Pcd for availability and information |                  |

| Cushion Block Specifications    |                                    |  |        |       |
|---------------------------------|------------------------------------|--|--------|-------|
| Materials                       | Specifications                     |  |        |       |
|                                 | Temperature Range                  | Chemical Resistance                                  | Color  | Duro  |
| Ethylene Propylene Rubber (EPR) | -65°F to 275°F<br>(-54°C to 135°C) | Areas exposed to Skydrol                             | Purple | 55-75 |
| Nitrile Butadiene (Buna-N)      |                                    | Fuel Tank Application                                | Yellow |       |
| Silicone                        |                                    | Fire Resistant, Low smoke, Low toxicity requirements | -      |       |
| Fluorosilicone                  | -65°F to 500°F<br>(-54°C to 260°C) | High temperature areas; Engine Applications          | -      |       |

## Custom Fairlead Blocks





Amphenol Pcd's Jig Board Clamps are made for pre-installation wire harness assembly. Made of Acetal, our durable clamps maintain their original shape after continuous use and their smooth edges diminish wear on the harnesses as they are being assembled. Developed in multiple sizes, Amphenol Pcd's Jig Board Clamps can accommodate a wide range of cable diameters, while the one-piece design enables efficient inventory management.



## Specifications

- Designed with Acetal: Strong durable; long life-time
- Various Sizes: Accommodates wide range of wire diameters
- One-Piece Design: Simple and easy to use
- Smooth Edges: Limits wire chaffing and reduces wear and tear
- No elastic band or straps required: Minimizes installation time



| Amphenol P/N  | Ø A (Inch) | B (Inch) | C (Inch) |
|---------------|------------|----------|----------|
| ALBCLP 001 01 | 0.50       | 1.85     | 0.375    |
| ALBCLP 001 02 | 1.25       | 2.81     | 0.625    |
| ALBCLP 001 03 | 2.00       | 3.80     | 0.625    |
| ALBCLP 001 04 | 0.88       | 2.36     | 0.500    |

Material: Acetal



# AMPHENOL PCD PRODUCTS



Backshells



Cable Solutions & Cable Adapters  
NEW



Relay Sockets & Junction Modules



System Attachments



Luminus Series, Pegasus Series  
NEW



Terminal Blocks



SIM



Rectangular



Circular



Waterproof Solutions



Field Bus



Military Audio /Power

## **Amphenol Pcd**

Amphenol Pcd, a subsidiary of Amphenol Corporation, is one of the world's leading suppliers of interconnect products for Military, Commercial Aerospace and Industrial applications. Located north of Boston in Beverly, Massachusetts, the company designs and manufactures a wide range of products - System Attachments, Junction Modules, Relay Sockets, Terminal Blocks, Rectangular & Circular connectors, and Cable Assemblies & Adapters.

Each product is made and engineered with the highest quality standards in the industry. With facilities in North America and Asia, Amphenol Pcd products are chosen by hundreds of OEMs around the world, reliant on Amphenol's technical excellence, global network of distributors, and cost-effective solutions for custom systems.

# Amphenol Pcd

Connecting People & Technology

Notice: Specifications are subject to change without notice. Contact your nearest Amphenol Corporation Sales Office for the latest specifications. All statements, information and data given herein are believed to be accurate and reliable, but are presented without guarantee, warranty, or responsibility of any kind expressed or implied. Statements or suggestions concerning possible use of our products are made without representation or warranty that any such use is free of patent infringement and are not recommendations to infringe any patent. The user should not assume that all safety measures are indicated or that other measures may not be required. Specifications are typical and may not apply to all connectors.

© 2015 Amphenol Pcd

**Amphenol Pcd**

72 Cherry Hill Dr. Beverly , MA. 01915

info@amphenolpcd.com • (978) 624.3400

www.amphenolpcd.com

**FOLLOW US**



Компания «Океан Электроники» предлагает заключение долгосрочных отношений при поставках импортных электронных компонентов на взаимовыгодных условиях!

Наши преимущества:

- Поставка оригинальных импортных электронных компонентов напрямую с производств Америки, Европы и Азии, а так же с крупнейших складов мира;
- Широкая линейка поставок активных и пассивных импортных электронных компонентов (более 30 млн. наименований);
- Поставка сложных, дефицитных, либо снятых с производства позиций;
- Оперативные сроки поставки под заказ (от 5 рабочих дней);
- Экспресс доставка в любую точку России;
- Помощь Конструкторского Отдела и консультации квалифицированных инженеров;
- Техническая поддержка проекта, помощь в подборе аналогов, поставка прототипов;
- Поставка электронных компонентов под контролем ВП;
- Система менеджмента качества сертифицирована по Международному стандарту ISO 9001;
- При необходимости вся продукция военного и аэрокосмического назначения проходит испытания и сертификацию в лаборатории (по согласованию с заказчиком);
- Поставка специализированных компонентов военного и аэрокосмического уровня качества (Xilinx, Altera, Analog Devices, Intersil, Interpoint, Microsemi, Actel, Aeroflex, Peregrine, VPT, Syfer, Eurofarad, Texas Instruments, MS Kennedy, Miteq, Cobham, E2V, MA-COM, Hittite, Mini-Circuits, General Dynamics и др.);

Компания «Океан Электроники» является официальным дистрибьютором и эксклюзивным представителем в России одного из крупнейших производителей разъемов военного и аэрокосмического назначения «JONHON», а так же официальным дистрибьютором и эксклюзивным представителем в России производителя высокотехнологичных и надежных решений для передачи СВЧ сигналов «FORSTAR».



## JONHON

«JONHON» (основан в 1970 г.)

Разъемы специального, военного и аэрокосмического назначения:

(Применяются в военной, авиационной, аэрокосмической, морской, железнодорожной, горно- и нефтедобывающей отраслях промышленности)

«FORSTAR» (основан в 1998 г.)

ВЧ соединители, коаксиальные кабели, кабельные сборки и микроволновые компоненты:

(Применяются в телекоммуникациях гражданского и специального назначения, в средствах связи, РЛС, а так же военной, авиационной и аэрокосмической отраслях промышленности).



Телефон: 8 (812) 309-75-97 (многоканальный)

Факс: 8 (812) 320-03-32

Электронная почта: [ocean@oceanchips.ru](mailto:ocean@oceanchips.ru)

Web: <http://oceanchips.ru/>

Адрес: 198099, г. Санкт-Петербург, ул. Калинина, д. 2, корп. 4, лит. А