

DELPHI SERIES



FEATURES

- ♦ High efficiency: 92% @ 12V/9A
- ♦ Size:
 - 58.4x22.8x11.0mm (2.30"x0.90"x0.43") w/o heat-spreader
 - 58.4x22.8x12.7mm (2.30"x0.90"x0.50") with heat-spreader
- ♦ Industry standard footprint and pinout
- ♦ Fixed frequency operation
- ♦ Input UVLO
- ♦ OTP and OVP
- ♦ Output OCP hiccup mode
- ♦ Output voltage trim down : -10%
- ♦ Output voltage trim up: +10% at $V_{in} > 20V$
- ♦ Monotonic startup into normal and pre-biased loads
- ♦ 1500V isolation and basic insulation
- ♦ No minimum load required
- ♦ No negative current during power or enable on/off
- ♦ ISO 9001, TL 9000, ISO 14001, QS 9000, OHSAS18001 certified manufacturing facility
- ♦ UL/cUL 60950-1 (US & Canada) recognized

Delphi Series E36SC120, Eighth Brick 108W DC/DC Power Modules: 18V~75V_{in}, 12V, 9A_{out}

The Delphi Series E36SC120, Eighth Brick, 18V~75V_{in} input, single output, isolated DC/DC converters, are the latest offering from a world leader in power systems technology and manufacturing — Delta Electronics, Inc. This product family provides up to 108 watts of power or 9A of output current. With creative design technology and optimization of component placement, these converters possess outstanding electrical and thermal performance, as well as extremely high reliability under highly stressful operating conditions. Typical efficiency of the 12V/9A module is greater than 92%.

OPTIONS

- ♦ Positive and negative remote On/Off
- ♦ SMD and through-hole versions
- ♦ Through hole with heat spreader

APPLICATIONS

- ♦ Optical Transport
- ♦ Data Networking
- ♦ Communications
- ♦ Servers

TECHNICAL SPECIFICATIONS

($T_A=25^\circ\text{C}$, airflow rate=300 LFM, $V_{in}=48\text{Vdc}$, nominal V_{out} unless otherwise noted.)

PARAMETER	NOTES and CONDITIONS	E36SC12009(Standard)			
		Min.	Typ.	Max.	Units
ABSOLUTE MAXIMUM RATINGS					
Input Voltage					Vdc
Continuous		0		80	Vdc
Transient (100ms)	100ms			100	Vdc
Operating Ambient Temperature		-40		85	$^\circ\text{C}$
Storage Temperature		-55		125	$^\circ\text{C}$
Input/Output Isolation Voltage				1500	Vdc
INPUT CHARACTERISTICS					
Operating Input Voltage		18	48	75	Vdc
Input Under-Voltage Lockout					
Turn-On Voltage Threshold		16.5	17.2	17.9	Vdc
Turn-Off Voltage Threshold		15.5	16.2	16.9	Vdc
Lockout Hysteresis Voltage		0.3	1.0	1.8	Vdc
Maximum Input Current	100% Load, 18Vin			7.7	A
No-Load Input Current	$V_{in}=48\text{V}$, $I_o=0\text{A}$		60		mA
Off Converter Input Current	$V_{in}=48\text{V}$		12		mA
Inrush Current (I2t)				1	A2s
Input Reflected-Ripple Current	P-P thru 12 μH inductor, 5Hz to 20MHz		20		mA
Input Voltage Ripple Rejection	120 Hz		50		dB
OUTPUT CHARACTERISTICS					
Output Voltage Set Point	$V_{in}=48\text{V}$, $I_o=I_{o,max}$, $T_c=25^\circ\text{C}$	11.82	12	12.18	Vdc
Output Voltage Regulation					
Over Load	$I_o=I_o, \text{min}$ to I_o, max		± 6	± 24	mV
Over Line	$V_{in}=18\text{V}$ to 75V		± 6	± 24	mV
Over Temperature	$T_c=-40^\circ\text{C}$ to 85°C		± 120		mV
Total Output Voltage Range	Over sample load, line and temperature	11.64	12	12.36	V
Output Voltage Ripple and Noise	5Hz to 20MHz bandwidth				
Peak-to-Peak	$V_{in}=48\text{V}$, Full Load, 1 μF ceramic, 10 μF tantalum		80		mV
RMS	$V_{in}=48\text{V}$, Full Load, 1 μF ceramic, 10 μF tantalum		20		mV
Operating Output Current Range	$V_{in}=18\text{V}$ to 75V	0		9	A
Operating Output Current Range					
Output Over Current Protection(hiccup mode)	Output Voltage 10% Low	110		140	%
DYNAMIC CHARACTERISTICS					
Output Voltage Current Transient	48Vin, 10 μF Tan & 1 μF Ceramic load cap, 0.1A/ μs				
Positive Step Change in Output Current	75% $I_{o,max}$ to 50% $I_{o,max}$		400		mV
Negative Step Change in Output Current	50% $I_{o,max}$ to 75% $I_{o,max}$		400		mV
Settling Time (within 1% V_{out} nominal)			200		μs
Turn-On Transient					
Start-Up Time, From On/Off Control			55		mS
Start-Up Time, From Input			55		mS
Output Capacitance (note 1)	Cap ESR $\geq 5\text{mohm}$; Full load; 5% overshoot of V_{out} at startup	0		2000	μF
EFFICIENCY					
100% Load	$V_{in}=24\text{V}$		92.5		%
100% Load	$V_{in}=48\text{V}$		92		%
60% Load	$V_{in}=48\text{V}$		91.5		%
ISOLATION CHARACTERISTICS					
Input to Output				1500	Vdc
Isolation Resistance		10			M Ω
Isolation Capacitance			1000		pF
FEATURE CHARACTERISTICS					
Switching Frequency			350		KHz
ON/OFF Control, Negative Remote On/Off logic					
Logic Low (Module On)	$V_{on/off}$	-0.7		0.8	V
Logic High (Module Off)	$V_{on/off}$	3.0		5	V
ON/OFF Control, Positive Remote On/Off logic					
Logic Low (Module Off)	$V_{on/off}$	-0.7		0.8	V
Logic High (Module On)	$V_{on/off}$	3.0		5	V
ON/OFF Current (for both remote on/off logic)	$I_{on/off}$ at $V_{on/off}=0.0\text{V}$			1	mA
Leakage Current (for both remote on/off logic)	Logic High, $V_{on/off}=5\text{V}$			50	μA
Output Voltage Trim Range(note 2)	$P_{out} \leq \text{max rated power}$, $I_o \leq I_{o,max}$	-10		10	%
Output Voltage Remote Sense Range	$P_{out} \leq \text{max rated power}$, $I_o \leq I_{o,max}$			10	%
Output Over-Voltage Protection	Over full temp range; % of nominal V_{out}	115		140	%
GENERAL SPECIFICATIONS					
MTBF	$I_o=80\%$ of I_o, max ; $T_a=25^\circ\text{C}$, airflow rate=300FLM		4.5		M hours
Weight	Without heat spreader		24.6		grams
Weight	With heat spreader		33.2		grams
Over-Temperature Shutdown (Without heat spreader)	Refer to Figure 19 for Hot spot 1 location (48Vin, 80% I_o , 200LFM, Airflow from Vin+ to Vin-)		130		$^\circ\text{C}$
Over-Temperature Shutdown (With heat spreader)	Refer to Figure 22 for Hot spot 2 location (48Vin, 80% I_o , 200LFM, Airflow from Vin+ to Vin-)		120		$^\circ\text{C}$
Over-Temperature Shutdown (NTC resistor)	Refer to Figure 19 for NTC resistor location		125		$^\circ\text{C}$

Note: Please attach thermocouple on NTC resistor to test OTP function, the hot spots' temperature is just for reference.

Note1: For applications with higher output capacitive load, please contact Delta.

Note2: Trim down range -10% for 18Vin ~75Vin, Trim up range +10% for 20Vin ~ 75Vin.

ELECTRICAL CHARACTERISTICS CURVES

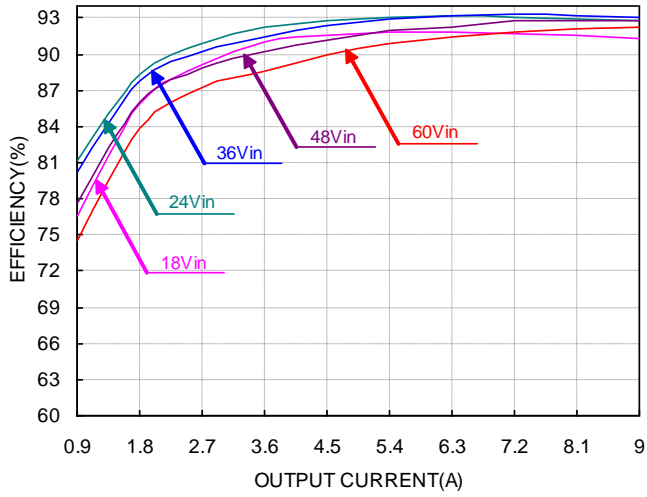

Figure 1: Efficiency vs. load current for minimum, nominal, and maximum input voltage at 25°C

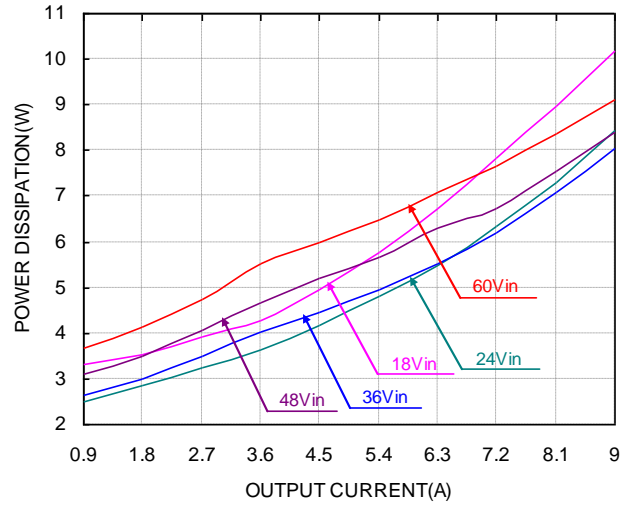

Figure 2: Power dissipation vs. load current for minimum, nominal, and maximum input voltage at 25°C.

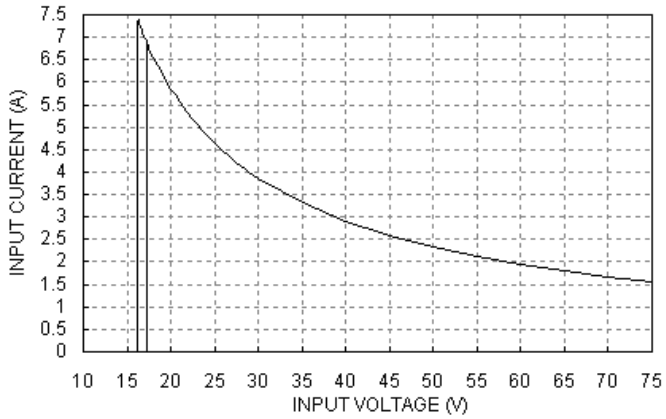

Figure 3: Typical full load input characteristics at room temperature

ELECTRICAL CHARACTERISTICS CURVES

For Negative Remote On/Off Logic

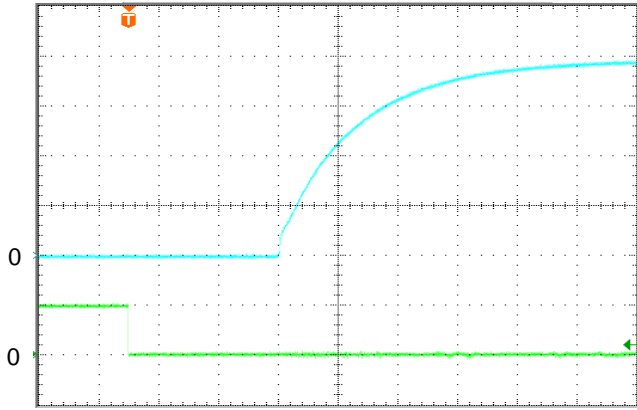

Figure 4: Turn-on transient at full rated load current (resistive load) (10 ms/div). $V_{in}=48V$. Top Trace: V_{out} , 3.0V/div; Bottom Trace: ON/OFF input, 5V/div

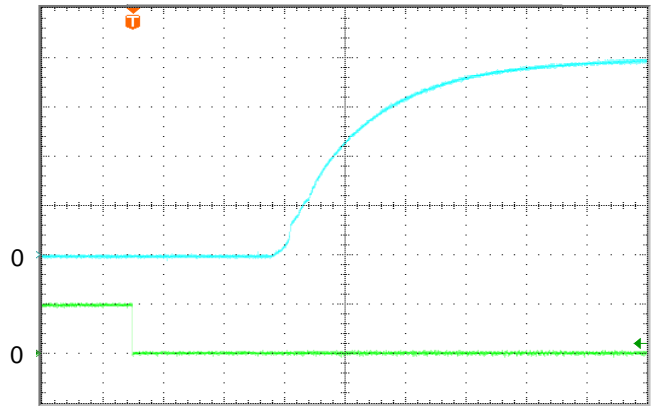

Figure 5: Turn-on transient at zero load current (10 ms/div). $V_{in}=48V$. Top Trace: V_{out} : 3.0V/div, Bottom Trace: ON/OFF input, 5V/div

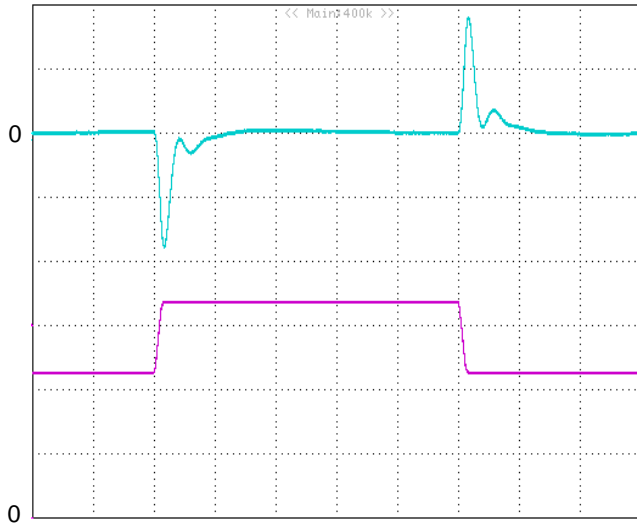

Figure 6: Output voltage response to step-change in load current (50%-75%-50% of $I_{o, max}$; $di/dt = 0.1A/\mu s$; V_{in} is 24V). Load cap: 10 μF tantalum capacitor and 1 μF ceramic capacitor. Top Trace: V_{out} (0.2V/div, 200 μs /div), Bottom Trace: I_{out} (2A/div). Scope measurement should be made using a BNC cable (length shorter than 20 inches). Position the load between 51 mm to 76 mm (2 inches to 3 inches) from the module

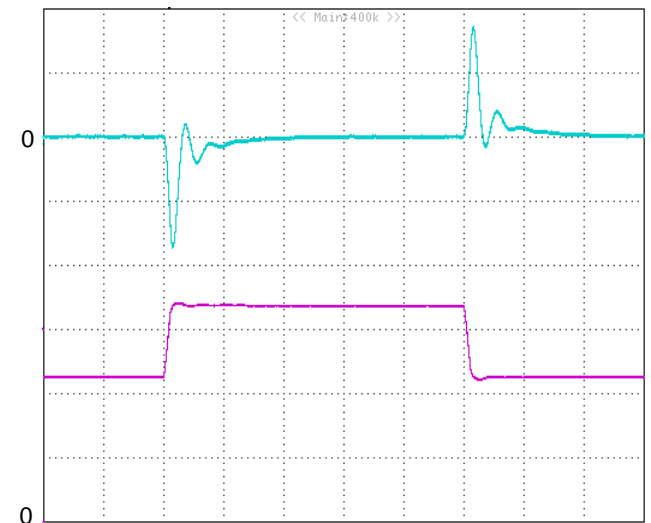

Figure 7: Output voltage response to step-change in load current (50%-75%-50% of $I_{o, max}$; $di/dt = 0.1A/\mu s$; V_{in} is 48V). Load cap: 10 μF tantalum capacitor and 1 μF ceramic capacitor. Top Trace: V_{out} (0.2V/div, 200 μs /div), Bottom Trace: I_{out} (2A/div). Scope measurement should be made using a BNC cable (length shorter than 20 inches). Position the load between 51 mm to 76 mm (2 inches to 3 inches) from the module

ELECTRICAL CHARACTERISTICS CURVES

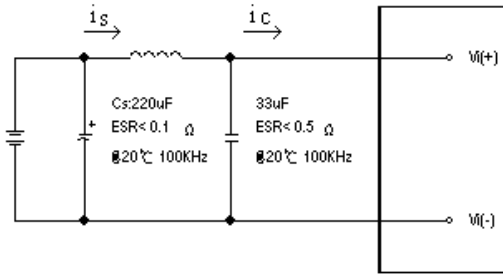

Figure 8: Test set-up diagram showing measurement points for Input Terminal Ripple Current and Input Reflected Ripple Current.

Note: Measured input reflected-ripple current with a simulated source Inductance (L_{TEST}) of 12 µH. Capacitor Cs offset possible battery impedance. Measure current as shown above

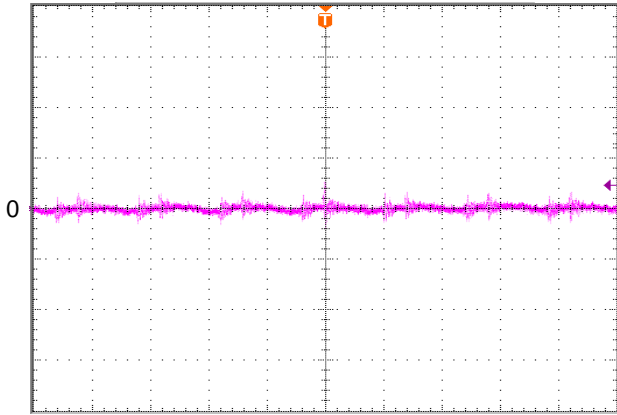

Figure 10: Input reflected ripple current, i_s , through a 12µH source inductor at nominal input voltage ($V_{in}=48V$) and rated load current (5mA/div, 2µs/div)

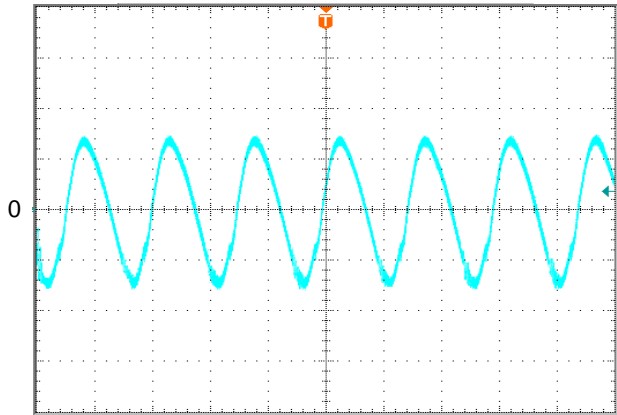

Figure 12: Output voltage ripple at nominal input voltage ($V_{in}=48V$) and rated load current ($I_o=9A$) (20mV/div, 2µs/div). Load capacitance: 1µF ceramic capacitor and 10µF tantalum capacitor. Bandwidth: 20 MHz. Scope measurements should be made using a BNC cable (length shorter than 20 inches). Position the load between 51 mm to 76 mm (2 inches to 3 inches) from the module

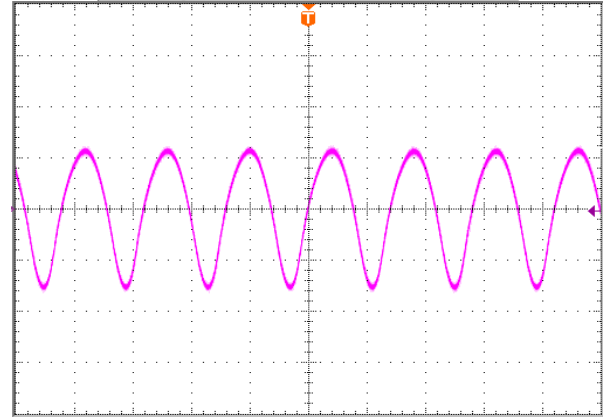

Figure 9: Input Terminal Ripple Current, i_c , at full rated output current and nominal input voltage ($V_{in}=48V$) with 12µH source impedance and 33µF electrolytic capacitor (250mA/div, 2µs/div)

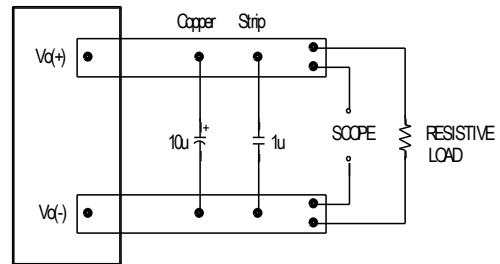

Figure 11: Output voltage noise and ripple measurement test setup

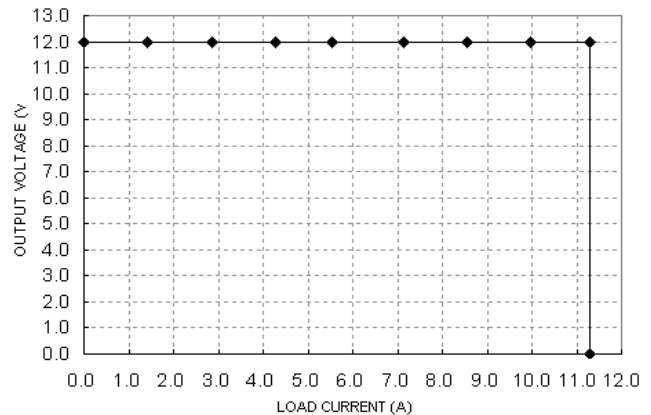

Figure 13: Output voltage vs. load current showing typical current limit curves and converter shutdown points ($V_{in}=48V$)

DESIGN CONSIDERATIONS

Input Source Impedance

The impedance of the input source connecting to the DC/DC power modules will interact with the modules and affect the stability. A low ac-impedance input source is recommended. If the source inductance is more than a few μH , we advise adding a 100 μF electrolytic capacitor (ESR < 0.7 Ω at 100 kHz) mounted close to the input of the module to improve the stability.

Layout and EMC Considerations

Delta's DC/DC power modules are designed to operate in a wide variety of systems and applications. For design assistance with EMC compliance and related PWB layout issues, please contact Delta's technical support team. An external input filter module is available for easier EMC compliance design. Below is the reference design for an input filter tested with E36SC12009 series to meet class B in CISPR 22.

Schematic and Components List:

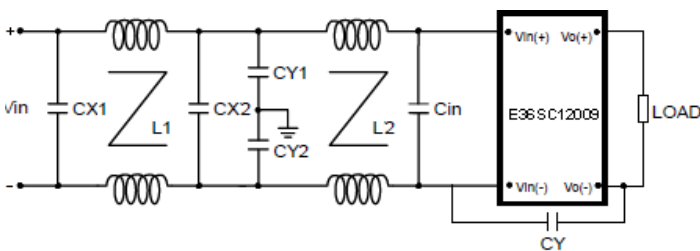

Cin is 100 μF low ESR Aluminum cap:

CY is 1nF ceramic cap:

CX1,CX2 are 2.2 μF ceramic cap:

CY1,CY2 are 3.3nF ceramic cap:

L1,L2 are common-mode inductor ,L1=L2=0.63mH:

Test Result: Vin=48V, Io=9A,

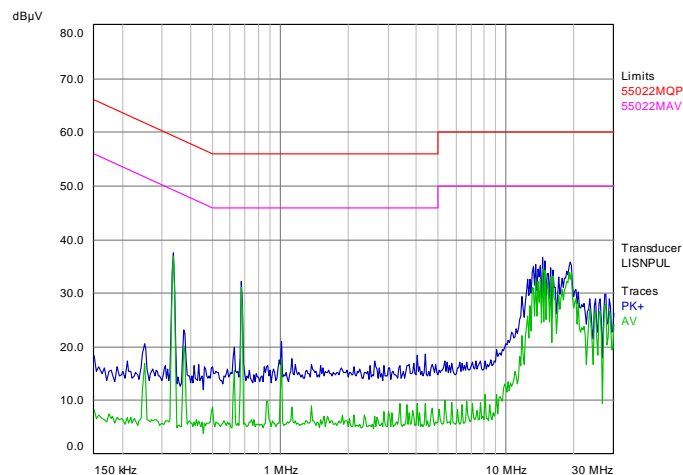

Blue Line is quasi peak mode; green line is average mode.

E36SC12009_12302015

Safety Considerations

The power module must be installed in compliance with the spacing and separation requirements of the end-user's safety agency standard, i.e., UL60950-1, CSA C22.2 NO. 60950-1 2nd and IEC 60950-1 2nd : 2005 and EN 60950-1 2nd: 2006+A11+A1: 2010, if the system in which the power module is to be used must meet safety agency requirements.

Basic insulation based on 75 Vdc input is provided between the input and output of the module for the purpose of applying insulation requirements when the input to this DC-to-DC converter is identified as TNV-2 or SELV. An additional evaluation is needed if the source is other than TNV-2 or SELV.

When the input source is SELV circuit, the power module meets SELV (safety extra-low voltage) requirements. If the input source is a hazardous voltage which is greater than 60 Vdc and less than or equal to 75 Vdc, for the module's output to meet SELV requirements, all of the following must be met:

- The input source must be insulated from the ac mains by reinforced or double insulation.
- The input terminals of the module are not operator accessible.
- A SELV reliability test is conducted on the system where the module is used, in combination with the module, to ensure that under a single fault, hazardous voltage does not appear at the module's output.

When installed into a Class II equipment (without grounding), spacing consideration should be given to the end-use installation, as the spacing between the module and mounting surface have not been evaluated.

The power module has extra-low voltage (ELV) outputs when all inputs are ELV.

This power module is not internally fused. To achieve optimum safety and system protection, an input line fuse is highly recommended. The safety agencies require a Fast-acting fuse with 20A maximum rating to be installed in the ungrounded lead. A lower rated fuse can be used based on the maximum inrush transient energy and maximum input current.

Soldering and Cleaning Considerations

Post solder cleaning is usually the final board assembly process before the board or system undergoes electrical testing. Inadequate cleaning and/or drying may lower the reliability of a power module and severely affect the finished circuit board assembly test. Adequate cleaning and/or drying is especially important for un-encapsulated and/or open frame type power modules. For assistance on appropriate soldering and cleaning procedures, please contact Delta's technical support team.

FEATURES DESCRIPTIONS

Over-Current Protection

The module include an internal output over-current protection circuit, which will endure current limiting for an unlimited duration during output overload. If the output current exceeds the OCP set point, the module will automatically shut down, and enter hiccup mode.

For hiccup mode, the module will try to restart after shutdown. If the over current condition still exists, the module will shut down again. This restart trial will continue until the over-current condition is corrected.

Over-Voltage Protection

The modules include an internal output over-voltage protection circuit, which monitors the voltage on the output terminals. If this voltage exceeds the over-voltage set point, the module will shut down, and enter in hiccup mode.

For hiccup mode, the module will try to restart after shutdown. If the over voltage condition still exists, the module will shut down again. This restart trial will continue until the over-voltage condition is corrected.

Over-Temperature Protection

The over-temperature protection consists of circuitry that provides protection from thermal damage. If the temperature exceeds the over-temperature threshold the module will shut down, and enter in auto-restart mode.

For auto-restart mode, the module will detect temperature after shutdown. If the over temperature condition still exists, the module will remain shutdown. This restart trial will continue until the over-temperature condition is corrected.

Remote On/Off

The remote on/off feature on the module can be either negative or positive logic. Negative logic turns the module on during a logic low and off during a logic high. Positive logic turns the modules on during a logic high and off during a logic low.

Remote on/off can be controlled by an external switch between the on/off terminal and the Vi(-) terminal. The switch can be an open collector or open drain.

For negative logic if the remote on/off feature is not used, please short the on/off pin to Vi(-). For positive logic if the remote on/off feature is not used, please leave the on/off pin floating.

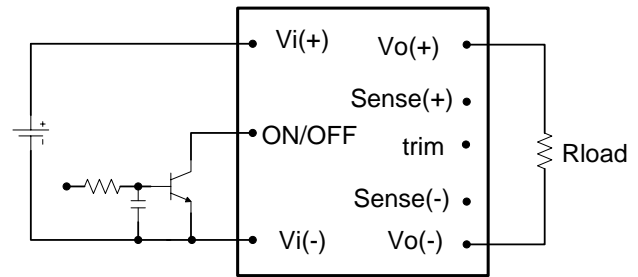

Figure 14: Remote on/off implementation

Remote Sense

Remote sense compensates for voltage drops on the output by sensing the actual output voltage at the point of load. The voltage between the remote sense pins and the output terminals must not exceed the output voltage sense range given here:

$$[Vo(+) - Vo(-)] - [SENSE(+) - SENSE(-)] \leq 10\% \times V_{out}$$

This limit includes any increase in voltage due to remote sense compensation and output voltage set point adjustment (trim).

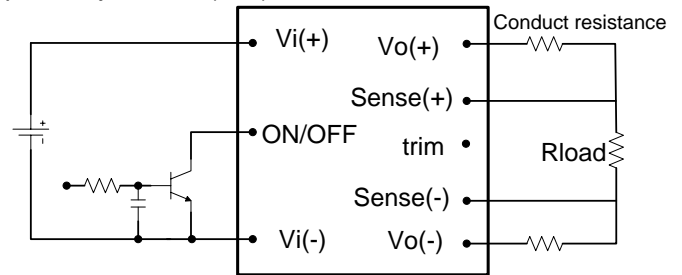

Figure 15: Effective circuit configuration for remote sense operation

FEATURES DESCRIPTIONS (CON.)

If the remote sense feature is not used to regulate the output at the point of load, please connect SENSE(+) to Vo(+) and SENSE(-) to Vo(-) at the module.

The output voltage can be increased by both the remote sense and the trim; however, the maximum increase is the larger of either the remote sense or the trim, not the sum of both.

When using remote sense and trim, the output voltage of the module is usually increased, which increases the power output of the module with the same output current.

Care should be taken to ensure that the maximum output power does not exceed the maximum rated power.

Output Voltage Adjustment (TRIM)

To increase or decrease the output voltage set point, connect an external resistor between the TRIM pin and either the SENSE(+) or SENSE(-). The TRIM pin should be left open if this feature is not used.

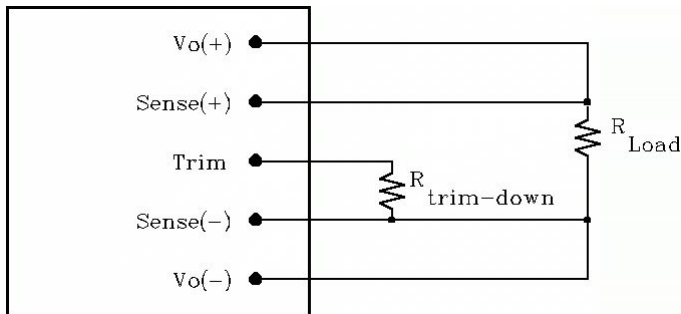

Figure 16: Circuit configuration for trim-down (decrease output voltage)

If the external resistor is connected between the TRIM and SENSE (-) pins, the output voltage set point decreases (Fig. 18). The external resistor value required to obtain a percentage of output voltage change $\Delta\%$ is defined as:

$$R_{trim-down} = \left[\frac{511}{\Delta} - 10.2 \right] (K\Omega)$$

Ex. When Trim-down -10% ($12V \times 0.9 = 10.8V$)

$$R_{trim-down} = \left[\frac{511}{10} - 10.2 \right] (K\Omega) = 40.9(K\Omega)$$

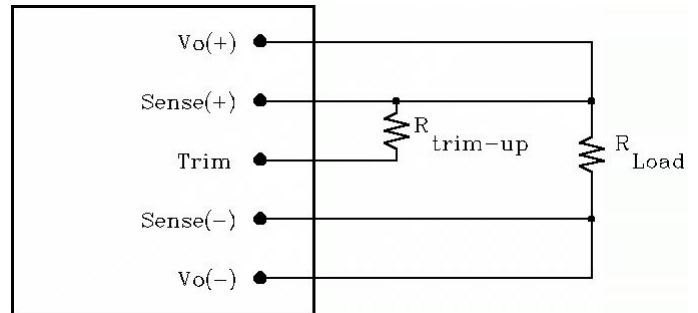

Figure 17: Circuit configuration for trim-up (increase output voltage)

If the external resistor is connected between the TRIM and SENSE (+) the output voltage set point increases (Fig. 19). The external resistor value required to obtain a percentage output voltage change $\Delta\%$ is defined as:

$$R_{trim-up} = \frac{5.11V_o(100 + \Delta)}{1.225\Delta} - \frac{511}{\Delta} - 10.2(K\Omega)$$

Ex. When Trim-up +10% ($12V \times 1.1 = 13.2V$)

$$R_{trim-up} = \frac{5.11 \times 12 \times (100 + 10)}{1.225 \times 10} - \frac{511}{10} - 10.2 = 489(K\Omega)$$

The output voltage can be increased by both the remote sense and the trim, however the maximum increase is the larger of either the remote sense or the trim, not the sum of both.

When using remote sense and trim, the output voltage of the module is usually increased, which increases the power output of the module with the same output current.

Care should be taken to ensure that the maximum output power of the module remains at or below the maximum rated power.

THERMAL CONSIDERATIONS

Thermal management is an important part of the system design. To ensure proper, reliable operation, sufficient cooling of the power module is needed over the entire temperature range of the module. Convection cooling is usually the dominant mode of heat transfer.

Hence, the choice of equipment to characterize the thermal performance of the power module is a wind tunnel.

Thermal Testing Setup

Delta's DC/DC power modules are characterized in heated vertical wind tunnels that simulate the thermal environments encountered in most electronics equipment. This type of equipment commonly uses vertically mounted circuit cards in cabinet racks in which the power modules are mounted.

The following figure shows the wind tunnel characterization setup. The power module is mounted on a test PWB and is vertically positioned within the wind tunnel. The space between the neighboring PWB and the top of the power module is constantly kept at 6.35mm (0.25").

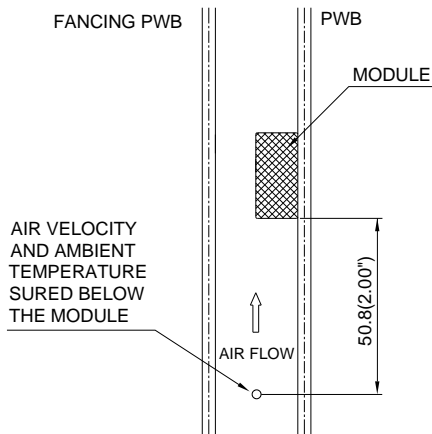

Note: Wind Tunnel Test Setup Figure Dimensions are in millimeters and (Inches)

Figure 18: Wind tunnel test setup

Thermal Derating

Heat can be removed by increasing airflow over the module. To enhance system reliability, the power module should always be operated below the maximum operating temperature. If the temperature exceeds the maximum module temperature, reliability of the unit may be affected.

THERMAL CURVES (WITHOUT HEAT SPREADER)

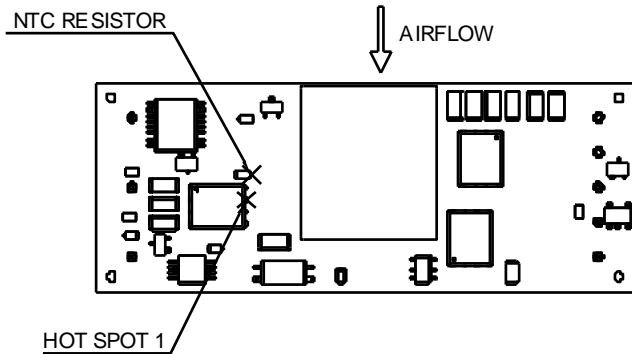

Figure 19: * Hot spot 1 & NTC resistor temperature measured points. The allowed maximum hot spot 1 temperature is defined at 115°C

THERMAL CURVES (WITH HEAT SPREADER)

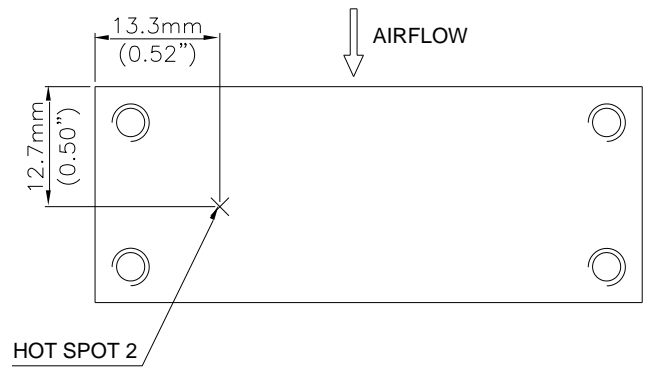

Figure 22: * Hot spot 2 temperature measured point. The allowed maximum hot spot 2 temperature is defined at 105°C

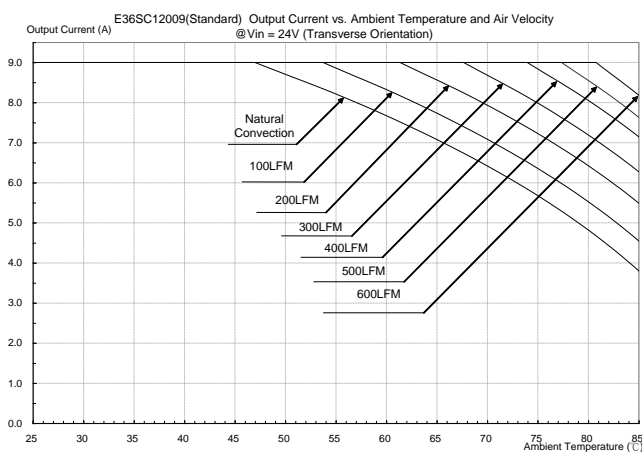

Figure 20: Output current vs. ambient temperature and air velocity @Vin=24V(Transverse Orientation, airflow from Vin+ to Vin-,without heat spreader)

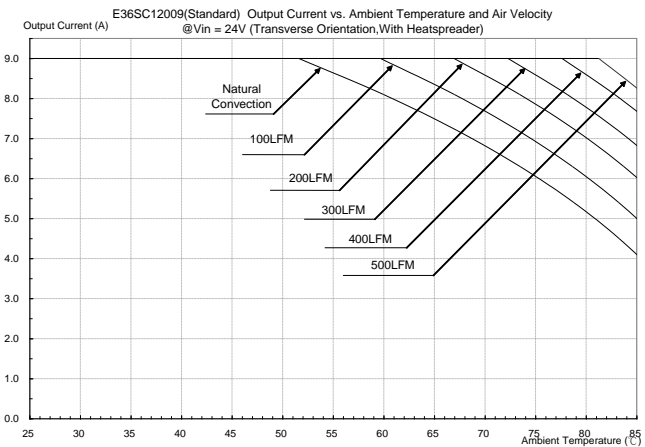

Figure 23: Output current vs. ambient temperature and air velocity @Vin=24V(Transverse Orientation, Airflow from Vin+ to Vin-,with heat spreader)

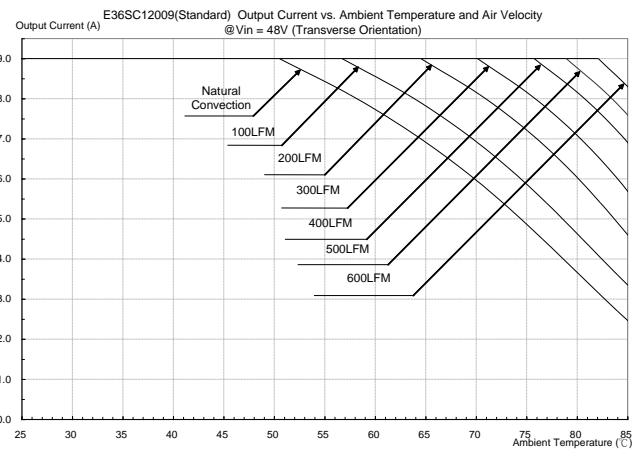

Figure 21: Output current vs. ambient temperature and air velocity @Vin=48V(Transverse Orientation, airflow from Vin+ to Vin-,without heat spreader)

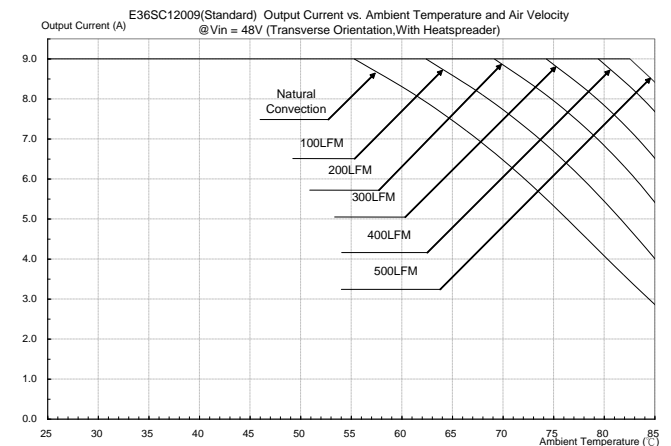
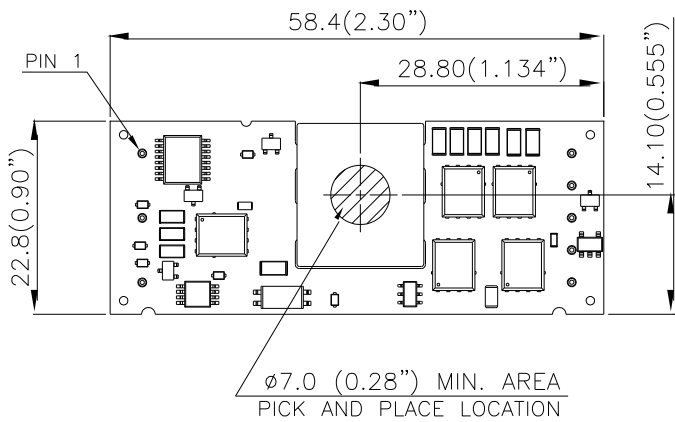

Figure 24: Output current vs. ambient temperature and air velocity @Vin=48V(Transverse Orientation, airflow from Vin+ to Vin-,with heat spreader)

PICK AND PLACE LOCATION



NOTES:
 DIMENSIONS ARE IN MILLIMETERS AND (INCHES)
 TOLERANCES: X.Xmm±0.5mm(X.XX in.±0.02 in.)
 X.XXmm±0.25mm(X.XXX in.±0.010 in.)

RECOMMENDED PAD LAYOUT (SMD)

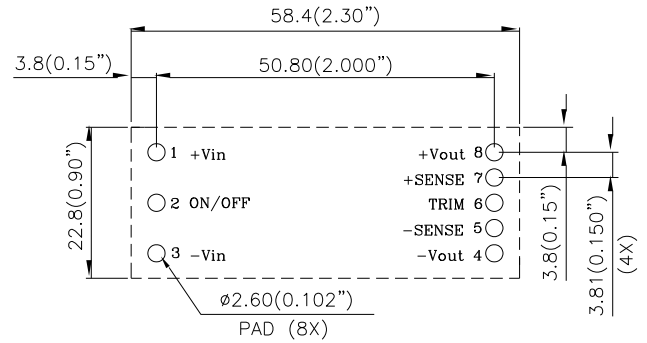

RECOMENDED P.W.B. PAD LAYOUT

NOTES:
 DIMENSIONS ARE IN MILLIMETERS AND (INCHES)
 TOLERANCES: X.Xmm±0.5mm(X.XX in.±0.02 in.)
 X.XXmm±0.25mm(X.XXX in.±0.010 in.)

SURFACE-MOUNT TAPE & REEL

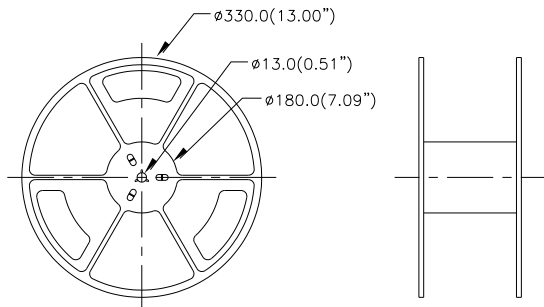
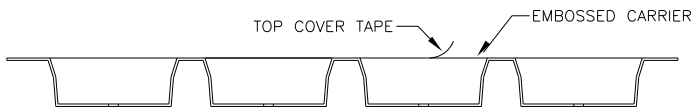
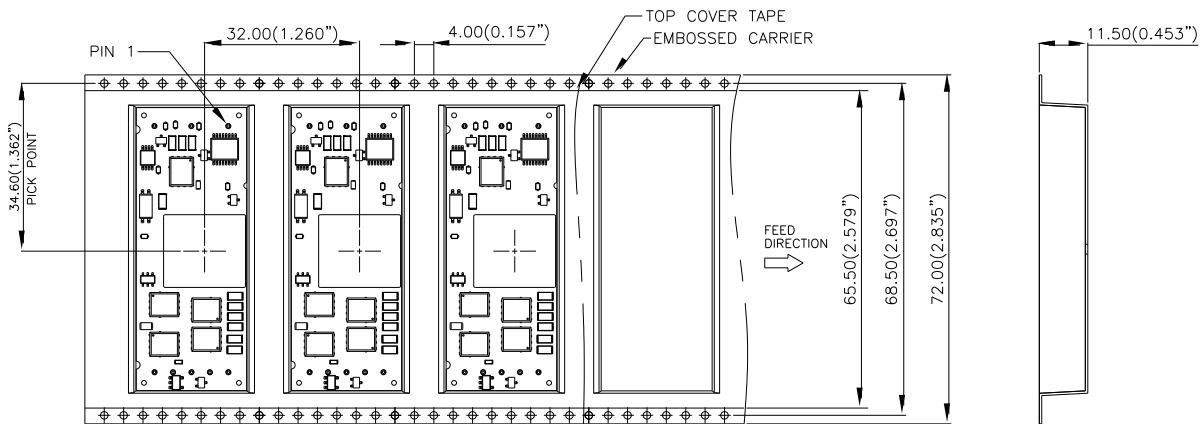

NOTES:
 CONFORMS TO EIA-481 SATNDARD
 MODULES ARE SHIPPED IN QUANTITIES OF 100 PER REEL.
 ALL DIMENSIONS ARE IN MILLIMETERS AND (INCHES)
 TOLERANCES: X.Xmm±0.5mm(X.XX in.±0.02 in.)
 X.XXmm±0.25mm(X.XXX in.±0.010 in.)

LEADED (SN/PB) PROCESS RECOMMEND TEMP. PROFILE(FOR SMD MODELS)

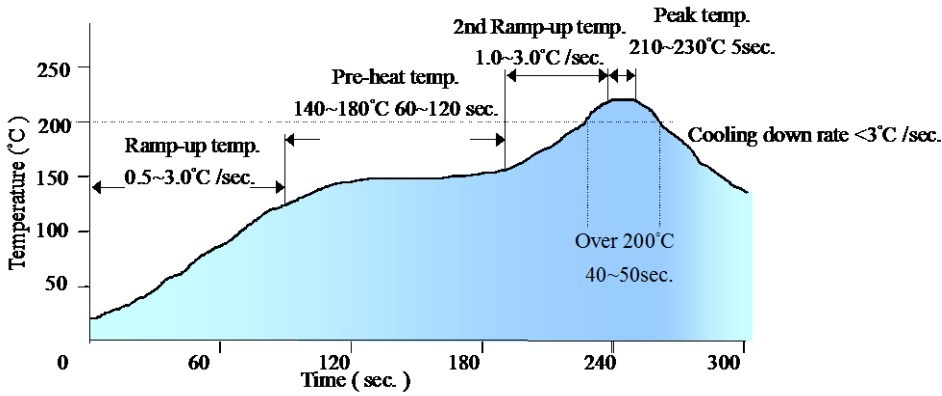

Note: The temperature refers to the pin of E36SC, measured on the +Vout pin joint.

LEAD FREE (SAC) PROCESS RECOMMEND TEMP. PROFILE(FOR SMD MODELS)

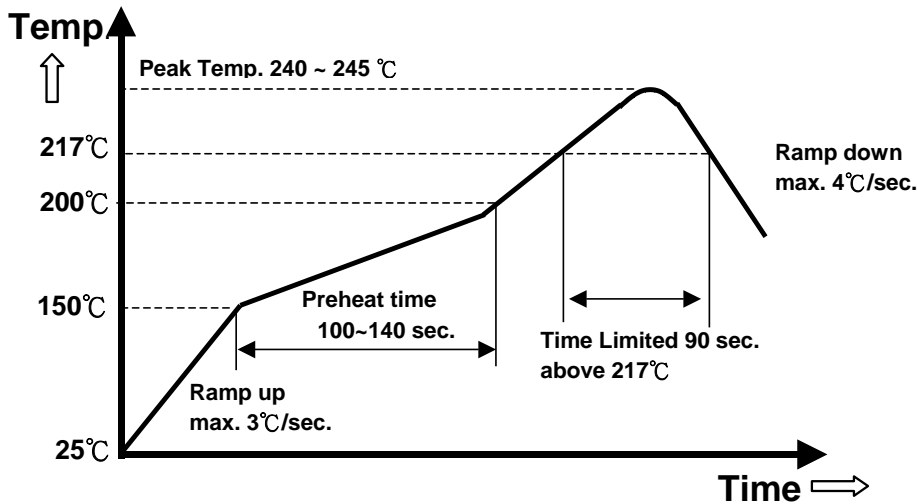

Note: The temperature refers to the pin of E36SC12009, measured on the +Vout pin joint.

MECHANICAL DRAWING (WITH HEAT-SPREADER)

* For modules with through-hole pins and the optional heatspreader, they are intended for wave soldering assembly onto system boards; please do not subject such modules through reflow temperature profile.

THROUGH-HOLE MODULE

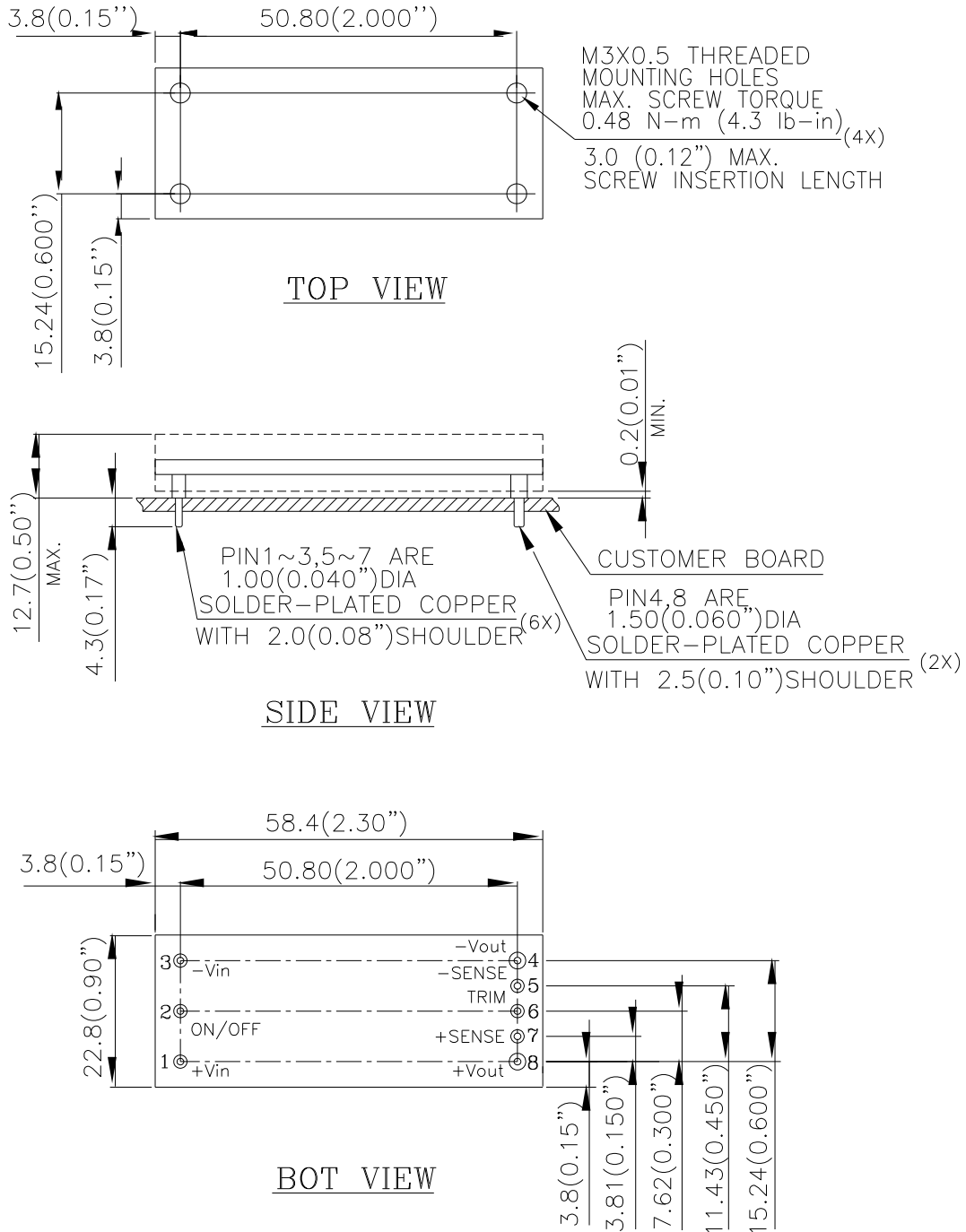

NOTES:

DIMENSIONS ARE IN MILLIMETERS AND (INCHES)

TOLERANCES: X.Xmm±0.5mm(X.XX in.±0.02 in.)

X.XXmm±0.25mm(X.XXX in.±0.010 in.)

MECHANICAL DRAWING (WITHOUT HEAT-SPREADER)

SURFACE-MOUNT MODULE

THROUGH-HOLE MODULE

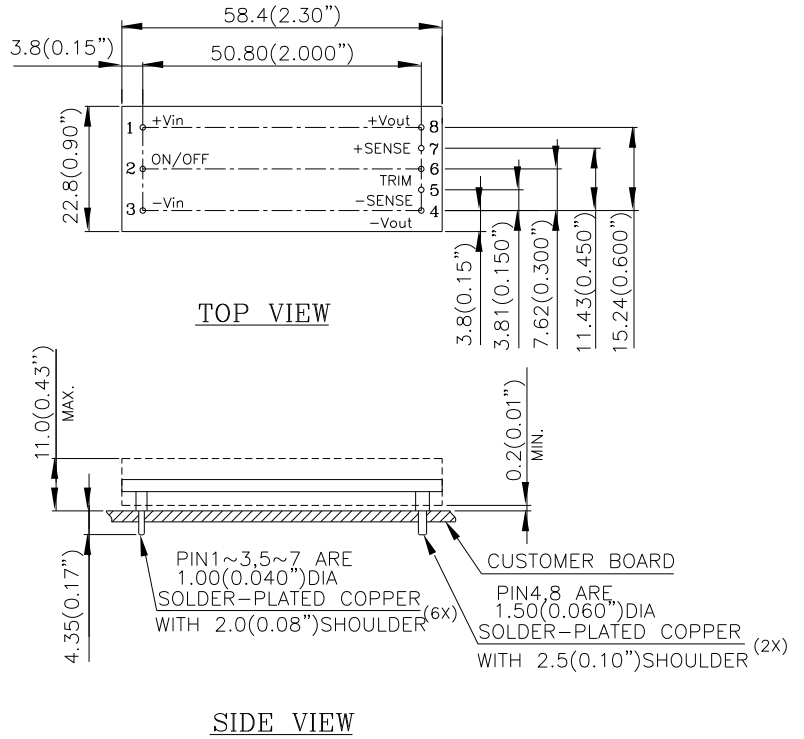
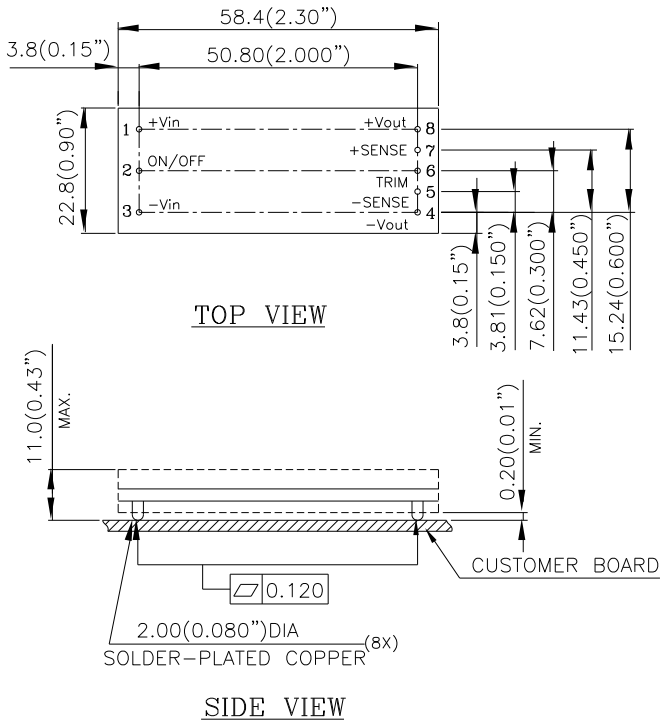

NOTES:
 DIMENSIONS ARE IN MILLIMETERS AND (INCHES)
 TOLERANCES: X.Xmm±0.5mm(X.XX in.±0.02 in.)
 X.XXmm±0.25mm(X.XXX in.±0.010 in.)

<u>Pin No.</u>	<u>Name</u>	<u>Function</u>
1	+Vin	Positive input voltage
2	ON/OFF	Remote ON/OFF
3	-Vin	Negative input voltage
4	-Vout	Negative output voltage
5	-SENSE	Negative remote sense
6	TRIM	Output voltage trim
7	+SENSE	Positive remote sense
8	+Vout	Positive output voltage

Note: All pins are copper alloy with matte tin(Pb free) plated over Ni under-plating.

RECOMMENDED PAD LAYOUT (THROUGH-HOLE MODULE)

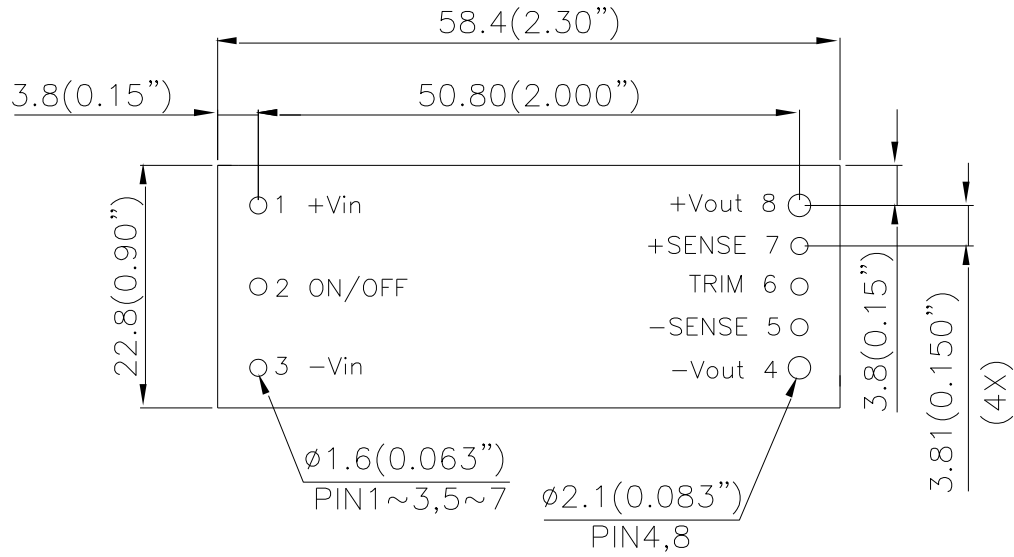

RECOMENDED P.W.B. PAD LAYOUT

NOTES:

DIMENSIONS ARE IN MILLIMETERS AND (INCHES)
 TOLERANCES: X.Xmm \pm 0.5mm(X.XX in. \pm 0.02 in.)
 X.XXmm \pm 0.25mm(X.XXX in. \pm 0.010 in.)

PART NUMBERING SYSTEM

E	36	S	C	120	09	N	R	F	A
Type of Product	Input Voltage	Number of Outputs	Product Series	Output Voltage	Output Current	ON/OFF Logic	Pin Length/Type		Option Code
E - 1/8 Brick	36 - 18V~75V	S - Single	C - Serial number	120 - 12V	09 - 9A	N - Negative P - Positive	R - 0.170" N - 0.146" K - 0.110" M - SMD	Space - RoHS 5/6 F - RoHS 6/6 (Lead Free)	A - Standard Functions H - with heat spreader

MODEL LIST

MODEL NAME	INPUT		OUTPUT		EFF @ 100% LOAD
E36SC12009NRFA	18V~75V	7.7A	12V	9A	92.0% @ 48Vin
E36SC12009NRFH	18V~75V	7.7A	12V	9A	92.0% @ 48Vin
E36SC12009NKFA	18V~75V	7.7A	12V	9A	92.0% @ 48Vin
E36SC12009NKFH	18V~75V	7.7A	12V	9A	92.0% @ 48Vin

Default remote on/off logic is negative and pin length is 0.170"

*** For modules with through-hole pins and the optional heatspreader, they are intended for wave soldering assembly onto system boards; please do not subject such modules through reflow temperature profile.**

CONTACT: www.deltaww.com/dcdc

Email: dcdc@deltaww.com

USA:

Telephone:
East Coast: 978-656-3993
West Coast: 510-668-5100
Fax: (978) 656 3964

Europe:

Phone: +31-20-655-0967
Fax: +31-20-655-0999

Asia & the rest of world:

Telephone: +886 3 4526107
Ext 6220~6224
Fax: +886 3 4513485

WARRANTY

Delta offers a two (2) year limited warranty. Complete warranty information is listed on our web site or is available upon request from Delta.

Information furnished by Delta is believed to be accurate and reliable. However, no responsibility is assumed by Delta for its use, nor for any infringements of patents or other rights of third parties, which may result from its use. No license is granted by implication or otherwise under any patent or patent rights of Delta. Delta reserves the right to revise these specifications at any time, without notice.

Компания «Океан Электроники» предлагает заключение долгосрочных отношений при поставках импортных электронных компонентов на взаимовыгодных условиях!

Наши преимущества:

- Поставка оригинальных импортных электронных компонентов напрямую с производств Америки, Европы и Азии, а так же с крупнейших складов мира;
- Широкая линейка поставок активных и пассивных импортных электронных компонентов (более 30 млн. наименований);
- Поставка сложных, дефицитных, либо снятых с производства позиций;
- Оперативные сроки поставки под заказ (от 5 рабочих дней);
- Экспресс доставка в любую точку России;
- Помощь Конструкторского Отдела и консультации квалифицированных инженеров;
- Техническая поддержка проекта, помощь в подборе аналогов, поставка прототипов;
- Поставка электронных компонентов под контролем ВП;
- Система менеджмента качества сертифицирована по Международному стандарту ISO 9001;
- При необходимости вся продукция военного и аэрокосмического назначения проходит испытания и сертификацию в лаборатории (по согласованию с заказчиком);
- Поставка специализированных компонентов военного и аэрокосмического уровня качества (Xilinx, Altera, Analog Devices, Intersil, Interpoint, Microsemi, Actel, Aeroflex, Peregrine, VPT, Syfer, Eurofarad, Texas Instruments, MS Kennedy, Miteq, Cobham, E2V, MA-COM, Hittite, Mini-Circuits, General Dynamics и др.);

Компания «Океан Электроники» является официальным дистрибьютором и эксклюзивным представителем в России одного из крупнейших производителей разъемов военного и аэрокосмического назначения «JONHON», а так же официальным дистрибьютором и эксклюзивным представителем в России производителя высокотехнологичных и надежных решений для передачи СВЧ сигналов «FORSTAR».



JONHON

«JONHON» (основан в 1970 г.)

Разъемы специального, военного и аэрокосмического назначения:

(Применяются в военной, авиационной, аэрокосмической, морской, железнодорожной, горно- и нефтедобывающей отраслях промышленности)

«FORSTAR» (основан в 1998 г.)

ВЧ соединители, коаксиальные кабели,
кабельные сборки и микроволновые компоненты:

(Применяются в телекоммуникациях гражданского и специального назначения, в средствах связи, РЛС, а так же военной, авиационной и аэрокосмической отраслях промышленности).



Телефон: 8 (812) 309-75-97 (многоканальный)

Факс: 8 (812) 320-03-32

Электронная почта: ocean@oceanchips.ru

Web: <http://oceanchips.ru/>

Адрес: 198099, г. Санкт-Петербург, ул. Калинина, д. 2, корп. 4, лит. А