

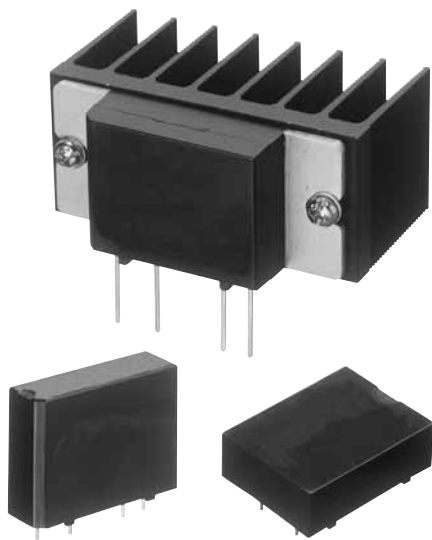

**High capacity up to 10 A  
PCB terminal type SSR**

# AQ1 RELAYS



RoHS compliant

### FEATURES

**1. 10 A high-capacity realized for PCB board terminal (when using heat sink) SSR for compact PC boards with 10 A capacity that is two times greater than our previous model. It is suitable for long-life, highly frequent control.**

SSR for compact PC boards with 10 A capacity that is two times greater than our previous model. It is suitable for long-life, highly frequent control.

**2. VDE (EN60950-1) reinforced insulation compliant**

Fully satisfies demand for safety by guaranteeing compliance with EN60950-1 safety standard and featuring 3,000 V reinforced insulation (AQ3A2-ZT4/32VDC, AQ3A2-J-ZT4/32VDC and AQ10A2-ZT4/32VDC).

**3. Superior anti-vibration and anti-shock characteristics**

The body is molded as a single unit with flame resistant resin which makes it highly resistant against vibration and shock, and gives it superior protection from environment. The body can also be washed.

**4. Vertical types with SIL terminal arrangement and flat types are available.**

1) The vertical type is available in thicknesses of 10 mm (3 A types) and 12 mm (10 A type). Terminal arrangement is SIL in integral multiples of 2.54 mm (0.1 inch).

2) The height of the flat type is 12 mm. The terminal arrangement is DIL in integral multiples of 2.54 mm.

**5. Reduced noise generation**

The load will operate at close to zero voltage even when the input signal is applied during a cycle. Also, even if an input signal is cancelled during a cycle, the load is cut off at close to zero current. For this reason, hardly any noise is produced and radio frequency interference (RFI) and electromagnetic interference (EMI) are kept to a minimum.

**6. Built-in snubber circuit prevents malfunction.**

### TYPICAL APPLICATIONS

- Printing machines
- Packing machines
- Automatic ticket punchers
- Terminal equipment of data processing
- Computer peripherals
- NC machines

### ORDERING INFORMATION

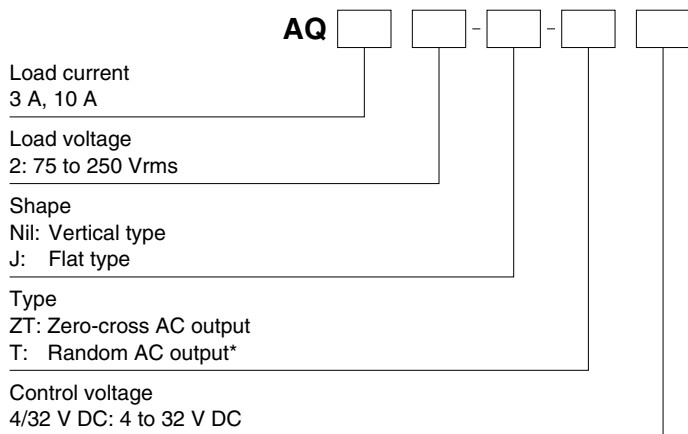

\* Random types are available by custom order.

## TYPES

### 1. AQ1 Solid State Relays

Load	Isolation	Zero-cross function	Type	Load current	Load voltage	Control voltage	Part No.
AC	Phototriac coupler	Zero-cross*1	Vertical	3 A	75 to 250 Vrms	4 to 32 V DC	AQ3A2-ZT4/32VDC
			Flat	3 A	75 to 250 Vrms	4 to 32 V DC	AQ3A2-J-ZT4/32VDC
			Vertical	10 A*2	75 to 250 Vrms	4 to 32 V DC	AQ10A2-ZT4/32VDC

Standard packing: Carton 20 pcs., Case 200 pcs.

Notes: \*1. Random type also available. Please contact our sales office.

\*2. 5 A without heat sink

### 2. Heat sink for AQ1 solid state relay

Product name	Part No.
Heat sink for AQ10A2-ZT4/32VDC	AQ-HS-5A

Standard packing: Carton 20 pcs., Case 200 pcs.

## SPECIFICATIONS

### 1. Rating (Ambient temperature: 20°C 68°F, Ripple factor: less than 1%)

Item	Part No.	AQ3A2-ZT4/32V DC AQ3A2-J-ZT4/32V DC	AQ10A2-ZT4/32V DC	Remarks	
Input side	Control voltage	4 to 32 V DC		*1	
	Input impedance	—			
	Input current, max.	20 mA			
	Drop-out voltage, min.	1.0 V			
Load side	Max. load current*2	3 A	10 A*5	Refer to REFERENCE DATA "1. Load current vs. ambient temperature characteristics".	
	Load voltage	75 to 250 Vrms			
	Frequency	45 to 65 Hz			
	Non-repetitive surge current*3	100 A			AC: In one cycle at 60 Hz
	Max. "OFF-state" leakage current	5 mA			AC: at 200 V, 60 Hz
	Max. "ON-state" voltage drop	1.6 V			At Max. carrying current
	Min. load current*4	50 mA			

Notes: \*1. Refer to REFERENCE DATA "3. Input current vs. input voltage characteristics".

\*2. Refer to REFERENCE DATA "1. Load current vs. ambient temperature".

\*3. Refer to REFERENCE DATA "2. Non-repetitive surge current vs. carrying time".

\*4. When load current is below the rating, refer to "Cautions for Use of Solid State Relays".

\*5. When heat sink (AQ-HS-5A) is installed. The max. load current is 5 A when heat sink is not installed.

### 2. Characteristics (Ambient temperature: 20°C 68°F, Ripple factor: less than 1%)

Item	Part No.	AQ3A2-ZT4/32V DC AQ3A2-J-ZT4/32V DC	AQ10A2-ZT4/32V DC	Remarks
Operate time, Max.		1/2 cycle of voltage sine wave +1 ms		
Release time, Max.		1/2 cycle of voltage sine wave +1 ms		
Insulation resistance, Min.		100 MΩ for input, output and case		at 500 V DC
Breakdown voltage		4,000 Vrms between input and output 2,500 Vrms between input, output and case		For 1 minute
Vibration resistance	Destructive	10 to 55 Hz at double amplitude of 2 mm		1 hour for X, Y, Z axis
	Functional	10 to 55 Hz at double amplitude of 2 mm		10 minutes for X, Y, Z axis
Shock resistance	Destructive	Min. 980 m/s <sup>2</sup> {100 G}		5 times each for X, Y, Z axis
	Functional	Min. 980 m/s <sup>2</sup> {100 G}		4 times each for X, Y, Z axis
Ambient temperature		-30 to +80°C -22 to +176°F		Non-condensing at low temperatures
Storage temperature		-30 to +100°C -22 to +212°F		Non-condensing at low temperatures
Operational method		Zero-cross (Turn-ON and Turn-OFF)		

## REFERENCE DATA

1.-(1) Load current vs. ambient temperature  
(3 A type) Part No.: AQ3A2-ZT4/32VDC and AQ3A2-J-ZT4/32VDC  
Allowable ambient temperature:  
-30 to +80°C -22 to +176°F

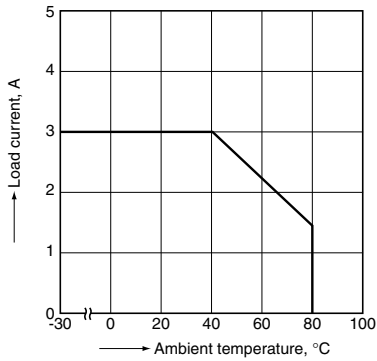

1.-(2) Load current vs. ambient temperature  
(10 A type) Part No.: AQ10A2-ZT4/32VDC  
(A) When not using a heat sink  
(B) When using a standard heat sink AQ-HS-5A  
(When attached to a heat sink, use a heat conductive compound (Ex. Momentive Performance Materials Inc. YG6111 or TSK5303) of similar coating to improve cooling.)

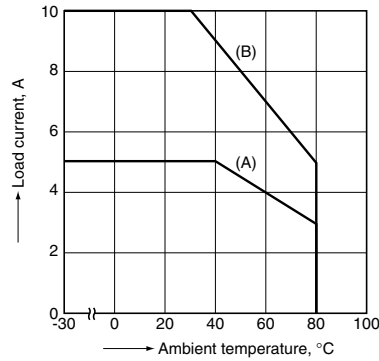

2. Non-repetitive surge current vs. carrying time\*  
(3 A and 10 A types)  
Part No.: AQ3A2-ZT4/32VDC, AQ3A2-J-ZT4/32VDC and AQ10A2-ZT4/32VDC

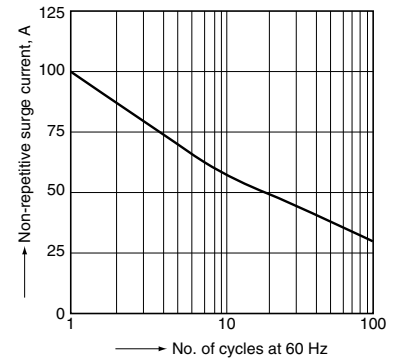

Note: \*The above chart shows non-repetitive maximum rating. If a surge current is applied repeatedly, please keep it approximately 50% or less than the values shown in the above graph.

3. Input current vs. input voltage characteristics  
(3 A and 10 A types)  
Part No.: AQ3A2-ZT4/32VDC, AQ3A2-J-ZT4/32VDC and AQ10A2-ZT4/32VDC

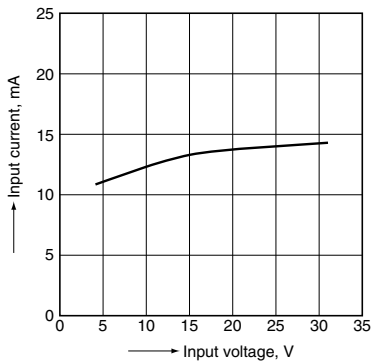

4.-(1) Load current vs. ambient temperature characteristics for adjacent mounting  
(3 A vertical type)  
Part No.: AQ3A2-ZT4/32VDC

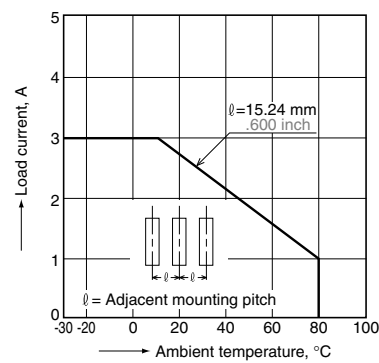

4.-(2) Load current vs. ambient temperature characteristics for adjacent mounting  
(10 A type)  
Part No.: AQ10A2-ZT4/32VDC (without heat sink)

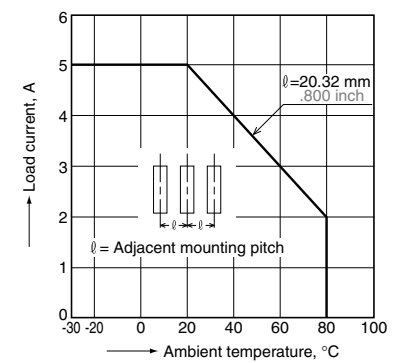

**DIMENSIONS** (mm inch)

The CAD data of the products with a **CAD** mark can be downloaded from: <https://industrial.panasonic.com/ac/e/>

**1. 3 A type (Vertical)**

**CAD**



External dimensions

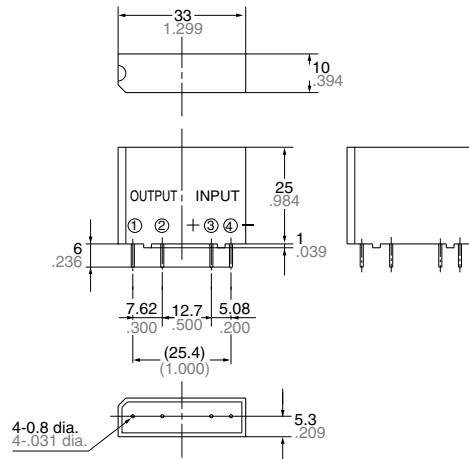

Mounting hole location  
(Copper-side view)

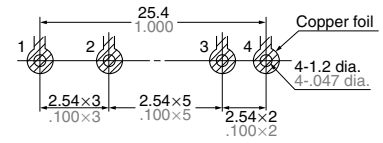

Tolerance:  $\pm 0.1 \pm .004$

General tolerance:  $\pm 0.5 \pm .020$

**2. 3 A type (Flat)**

**CAD**



External dimensions

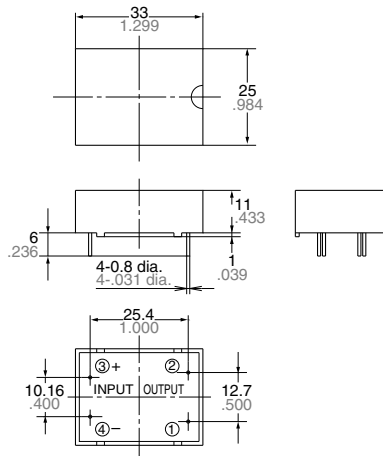

Mounting hole location  
(Copper-side view)

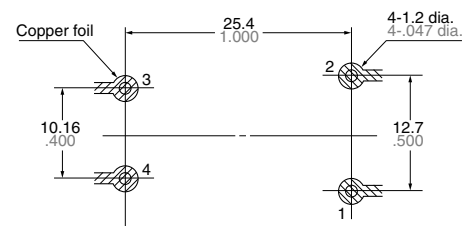

Tolerance:  $\pm 0.1 \pm .004$

General tolerance:  $\pm 0.5 \pm .020$

**3. 10 A type (Vertical)**

**CAD**

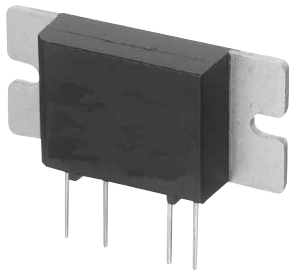

External dimensions

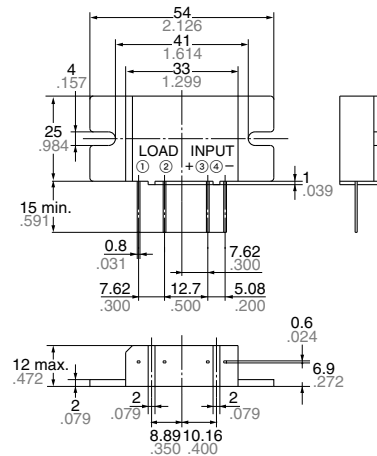

Mounting hole location (Copper-side view)

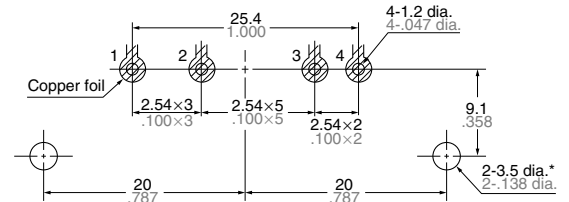

\* There 2 holes are not necessary when not using heat sink (AQ-HS-5A)

Tolerance:  $\pm 0.1 \pm .004$

General tolerance:  $\pm 0.5 \pm .020$

4. Heat sink (for AQ10A2-ZT4/32VDC)

CAD

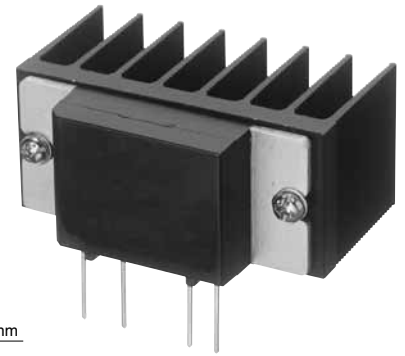
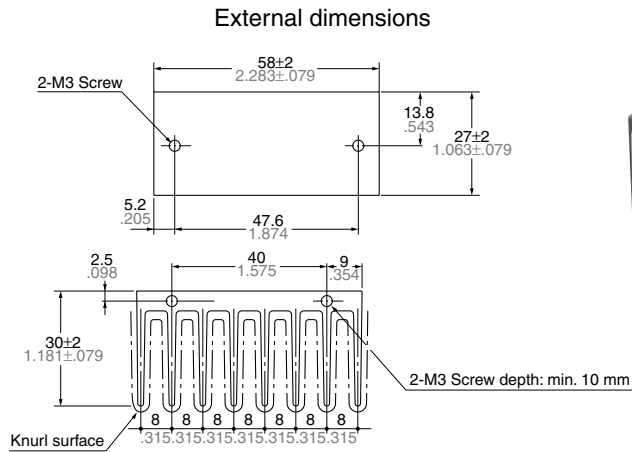

Heat sink attached to AQ1 relay

General tolerance:  $\pm 0.5 \pm 0.20$

Note: When using heat sink, please refer to “2. Thermal design” of NOTES.

**SCHEMATIC AND WIRING DIAGRAMS**

Schematic	Output configuration	Load	Wiring diagram
	<p>1 Form A</p>	<p>AC</p>	<p>Vertical type</p>
			<p>Flat type</p>

**NOTES**

**1. When using bent output terminals**  
To avoid applying mechanical stress on the main unit and molded section of the solid state relay, radio pliers should be used to grasp the terminals between the point of bending and the molded case when making the bends.

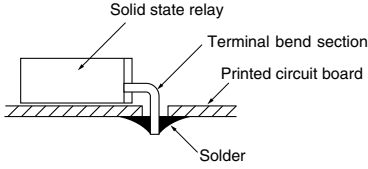

**2. Thermal design**  
**When a heat sink is mounted on the 10 A type**

The heat sink (AQ-HS-5A) or a radiator which can make good contact should be used.

If a heat sink is used in which the contact condition is bad, a heat conducting compound should be used to improve the heat radiation. (Ex. Momentive Performance Materials Inc. YG6111 or TSK5303) The compound should be applied between the heat sink and the AQ1.

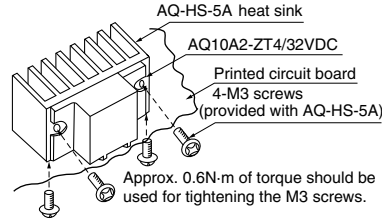

**Recommended Temperature Controllers**

**<KT4H Temperature Controller>**

Our temperature controller is recommended for use with our Solid State Relays.

**Features**

- Space saving requiring only a depth of 65 mm
- Data collection possible through a PLC using RS485 communication
- Tool port is standard for easy data setting
- Inverted LCD + backlight for good legibility with large characters
- Excellent operability and rich optional control functions

**Substitute part numbers**

Power supply	Control output	Part No.
100 to 240 Vrms	Non-contact voltage output	AKT4H112100

\* For detailed product information about temperature controllers, please refer to our website:  
<https://industrial.panasonic.com/ac/e/>

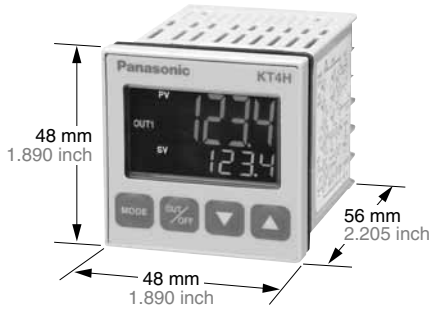

---

Please contact .....

**Panasonic Corporation**

Electromechanical Control Business Division

■ 1006, Oaza Kadoma, Kadoma-shi, Osaka 571-8506, Japan  
[industrial.panasonic.com/ac/e/](http://industrial.panasonic.com/ac/e/)

**Panasonic**<sup>®</sup>

©Panasonic Corporation 2018

# Mouser Electronics

Authorized Distributor

Click to View Pricing, Inventory, Delivery & Lifecycle Information:

## Panasonic:

[AQ2A2-C1-ZT24VDC](#) [AQ2A2-C1-ZT12VDC](#) [AQ2A2-C1-T12VDC](#) [AQ2A2-J-ZP3/28VDC](#) [AQ2A2-C2-T5VDC](#) [AQ3A2-C1-ZT5VDC](#) [AQ2A2-C2-ZT12VDC](#) [AQ3A2-C1-T5VDC](#) [AQ3A2-C2-T5VDC](#) [AQ10A2-ZT4/32VDC](#) [AQ3A2-C2-ZT5VDC](#) [AQ2A2-C2-ZT5VDC](#) [AQ3A2-C2-ZT12VDC](#) [AQ2A2-C1-ZT5VDC](#) [AQ3A2-C2-T12VDC](#) [AQ2A2-C2-T12VDC](#) [AQ2A2-C2-T24VDC](#) [AQ2A2-C2-ZT24VDC](#) [AQ3A2-C1-ZT12VDC](#) [AQ3A2-C1-T24VDC](#) [AQ2A2-C1-T5VDC](#) [AQ2A2-C1-T24VDC](#) [AQ2A2-ZP3/28VDC](#) [AQ5A2-ZP3/28VDC](#) [AQ3A2-ZT4/32VDC](#) [AQ3A2-C1-ZT24VDC](#)



Компания «Океан Электроники» предлагает заключение долгосрочных отношений при поставках импортных электронных компонентов на взаимовыгодных условиях!

Наши преимущества:

- Поставка оригинальных импортных электронных компонентов напрямую с производств Америки, Европы и Азии, а так же с крупнейших складов мира;
- Широкая линейка поставок активных и пассивных импортных электронных компонентов (более 30 млн. наименований);
- Поставка сложных, дефицитных, либо снятых с производства позиций;
- Оперативные сроки поставки под заказ (от 5 рабочих дней);
- Экспресс доставка в любую точку России;
- Помощь Конструкторского Отдела и консультации квалифицированных инженеров;
- Техническая поддержка проекта, помощь в подборе аналогов, поставка прототипов;
- Поставка электронных компонентов под контролем ВП;
- Система менеджмента качества сертифицирована по Международному стандарту ISO 9001;
- При необходимости вся продукция военного и аэрокосмического назначения проходит испытания и сертификацию в лаборатории (по согласованию с заказчиком);
- Поставка специализированных компонентов военного и аэрокосмического уровня качества (Xilinx, Altera, Analog Devices, Intersil, Interpoint, Microsemi, Actel, Aeroflex, Peregrine, VPT, Syfer, Eurofarad, Texas Instruments, MS Kennedy, Miteq, Cobham, E2V, MA-COM, Hittite, Mini-Circuits, General Dynamics и др.);

Компания «Океан Электроники» является официальным дистрибьютором и эксклюзивным представителем в России одного из крупнейших производителей разъемов военного и аэрокосмического назначения «JONHON», а так же официальным дистрибьютором и эксклюзивным представителем в России производителя высокотехнологичных и надежных решений для передачи СВЧ сигналов «FORSTAR».



## JONHON

«JONHON» (основан в 1970 г.)

Разъемы специального, военного и аэрокосмического назначения:

(Применяются в военной, авиационной, аэрокосмической, морской, железнодорожной, горно- и нефтедобывающей отраслях промышленности)

«FORSTAR» (основан в 1998 г.)

ВЧ соединители, коаксиальные кабели, кабельные сборки и микроволновые компоненты:

(Применяются в телекоммуникациях гражданского и специального назначения, в средствах связи, РЛС, а так же военной, авиационной и аэрокосмической отраслях промышленности).



Телефон: 8 (812) 309-75-97 (многоканальный)

Факс: 8 (812) 320-03-32

Электронная почта: [ocean@oceanchips.ru](mailto:ocean@oceanchips.ru)

Web: <http://oceanchips.ru/>

Адрес: 198099, г. Санкт-Петербург, ул. Калинина, д. 2, корп. 4, лит. А