



### Main

Range of product	Modicon TM5
Product or component type	Analog input module
Analogue input number	6
Analogue input type	Thermocouple - 210...1200 °C thermocouple J Thermocouple - 270...1300 °C thermocouple N Thermocouple - 270...1372 °C thermocouple K Thermocouple - 50...1768 °C thermocouple S
Analogue input resolution	16 bits

### Complementary

Range compatibility	Modicon LMC058 Modicon M258
Product compatibility	Motion controller Logic controller
Measurement resolution	0.1 °C
Color	White
Input filtering	1...66.7 ms configurable by software
Measurement error	+/- 0.1 % of full scale, - 210...1200 °C thermocouple J at 25 °C +/- 0.11 % of full scale, - 270...1300 °C thermocouple N at 25 °C +/- 0.11 % of full scale, - 270...1372 °C thermocouple K at 25 °C +/- 0.17 % of full scale, - 50...1768 °C thermocouple S at 25 °C
Temperature coefficient	0.01 %FS/°C, analogue input type: thermocouple
Non-linearity	+/- 0.001 %FS, analogue input type: thermocouple
Type of cable	Shielded cable
Isolation	No insulation between channels 500 Vrms AC insulation between channel and bus
Supply	Internal
[Us] rated supply voltage	24 V DC -15...20 %
Common mode rejection	> 70 dB
Local signalling	1 LED green power supply 1 LED red power supply 6 LEDs green input status
Current consumption	2 mA 5 V DC bus 38 mA 24 V DC input/output
Power dissipation in W	<= 0.92 W
Marking	CE
Product weight	0.06 lb(US) (0.025 kg)

### Environment

standards	CSA C22.2 No 142 IEC 61131-2 UL 508 CSA C22.2 No 213
product certifications	CSA C-Tick CULus GOST-R
ambient air temperature for operation	32...122 °F (0...50 °C) (vertical installation) 32...131 °F (0...55 °C) without derating factor (horizontal installation) 32...140 °F (0...60 °C) with derating factor (horizontal installation)
ambient air temperature for storage	-13...158 °F (-25...70 °C)

The information provided in this documentation contains general descriptions and/or technical characteristics of the products contained herein. This documentation is not intended as a substitute for and is not to be used for determining suitability or reliability of these products for specific user applications. It is the duty of any such user or integrator to perform the appropriate and complete risk analysis, evaluation and testing of the products with respect to the relevant specific application or use thereof. Neither Schneider Electric Industries SAS nor any of its affiliates or subsidiaries shall be responsible or liable for misuse of the information contained herein.

relative humidity	5...95 % without condensation
IP degree of protection	IP20 conforming to IEC 61131-2
pollution degree	2 conforming to IEC 60664
operating altitude	0...6561.68 ft (0...2000 m)
storage altitude	0...9842.52 ft (0...3000 m)
vibration resistance	1 gn (f= 8.4...150 Hz) DIN rail 3.5 mm (f= 5...8.4 Hz) DIN rail
shock resistance	15 gn 11 ms
resistance to electrostatic discharge	4 kV on contact conforming to EN/IEC 61000-4-2 8 kV in air conforming to EN/IEC 61000-4-2
resistance to electromagnetic fields	0.91 V/yd (1 V/m) 2...2.7 GHz conforming to EN/IEC 61000-4-3 9.14 V/yd (10 V/m) 80...2000 MHz conforming to EN/IEC 61000-4-3
resistance to fast transients	1 kV I/O conforming to EN/IEC 61000-4-4 1 kV shielded cable conforming to EN/IEC 61000-4-4 2 kV power lines conforming to EN/IEC 61000-4-4
surge withstand	0.5 kV differential mode conforming to EN/IEC 61000-4-5 1 kV common mode conforming to EN/IEC 61000-4-5
electromagnetic compatibility	EN/IEC 61000-4-6
disturbance radiated/conducted	CISPR 11

## Offer Sustainability

Green Premium product	Green Premium product
Compliant - since 1039 - Schneider Electric declaration of conformity	Compliant - since 1039 - Schneider Electric declaration of conformity
Reference not containing SVHC above the threshold	Reference not containing SVHC above the threshold
Available	Available
Available	Available
WARNING: This product can expose you to chemicals including:	WARNING: This product can expose you to chemicals including:
Lead and lead compounds, which is known to the State of California to cause cancer and birth defects or other reproductive harm.	Lead and lead compounds, which is known to the State of California to cause cancer and birth defects or other reproductive harm.
For more information go to <a href="http://www.p65warnings.ca.gov">www.p65warnings.ca.gov</a>	For more information go to <a href="http://www.p65warnings.ca.gov">www.p65warnings.ca.gov</a>

## Contractual warranty

Warranty period	18 months
-----------------	-----------

## TM5 Slice

### Dimensions

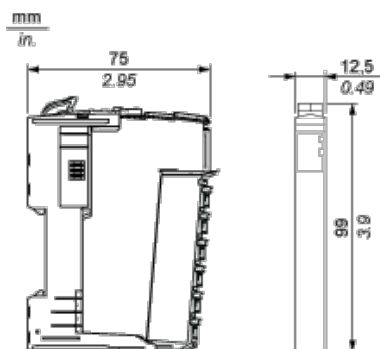

## TM5 System

### Spacing Requirements

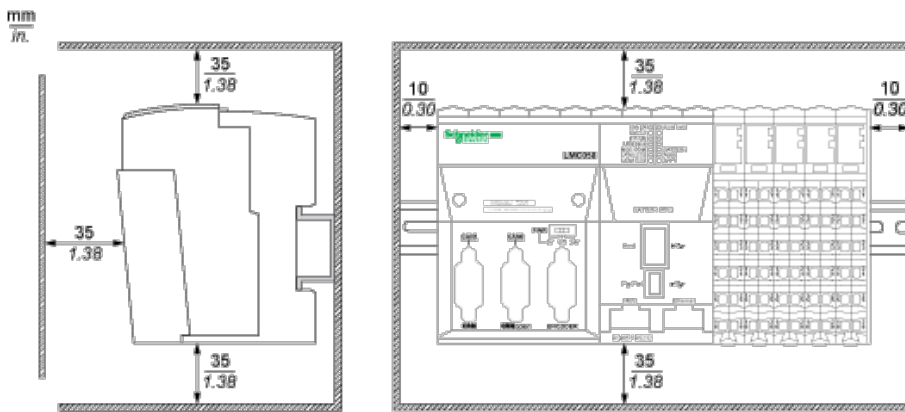



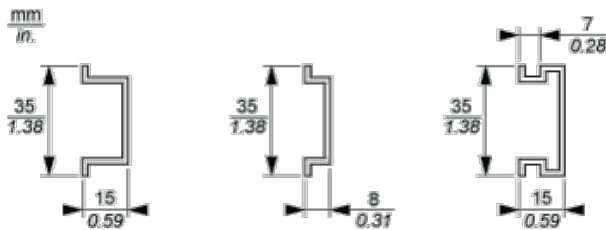

### Mounting on a DIN Rail



### TM5 System Wiring Recommendations

#### Wire Sizes to Use with the Removable Spring Terminal Blocks

mm in.				
mm <sup>2</sup>	0,08...2,5	0,25...2,5	0,25...1,5	2 x 0,25...2 x 0,75
AWG	28...14	24...14	24...16	2 x 24...2 x 18

### Electronic Module 6AI Thermocouple J/K/N/S 16 Bits

#### Wiring Diagram

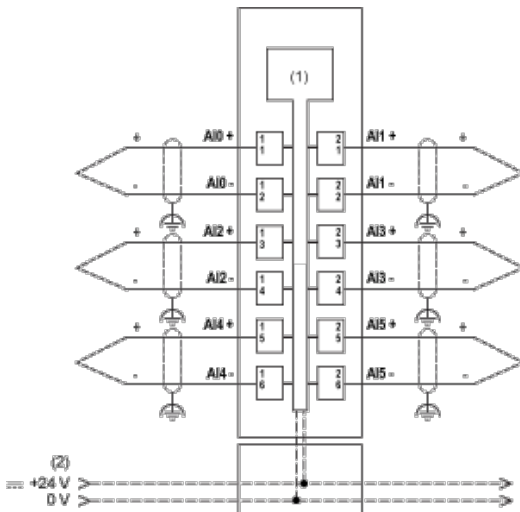

- (1) Internal electronics
- (2) 24 Vdc I/O power segment integrated into the bus bases

#### Ceramic Heating Element with Integrated Thermo Elements

Ripple voltage effects can potentially cause measurement errors.

The following figure shows the wiring diagram with a PDM:

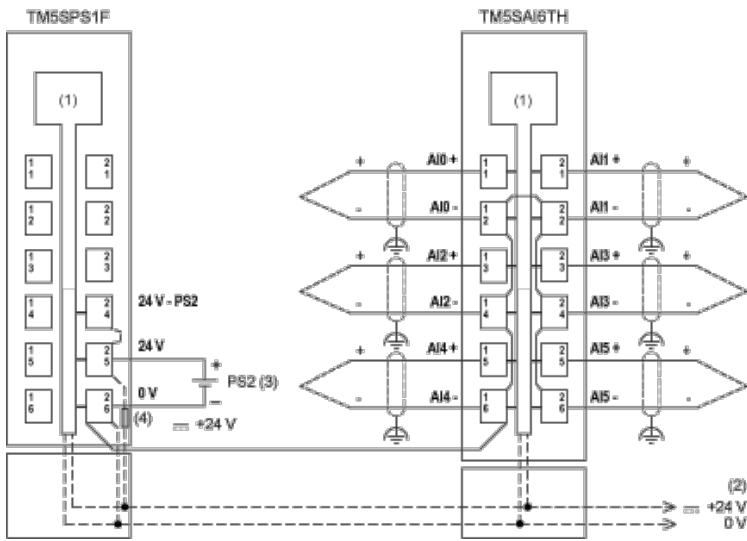

- (1) Internal electronics
- (2) 24 Vdc I/O power segment integrated into the bus bases
- (3) PS2: External isolated SELV power supply 24 Vdc limited to 200 VA for UL508 conformance, or limited to 150 VA for CSA 22.2, N° 142 conformance
- (4) Integrated fuse type T slow-blow 6.3 A 250 V exchangeable

Компания «Океан Электроники» предлагает заключение долгосрочных отношений при поставках импортных электронных компонентов на взаимовыгодных условиях!

Наши преимущества:

- Поставка оригинальных импортных электронных компонентов напрямую с производств Америки, Европы и Азии, а так же с крупнейших складов мира;
- Широкая линейка поставок активных и пассивных импортных электронных компонентов (более 30 млн. наименований);
- Поставка сложных, дефицитных, либо снятых с производства позиций;
- Оперативные сроки поставки под заказ (от 5 рабочих дней);
- Экспресс доставка в любую точку России;
- Помощь Конструкторского Отдела и консультации квалифицированных инженеров;
- Техническая поддержка проекта, помощь в подборе аналогов, поставка прототипов;
- Поставка электронных компонентов под контролем ВП;
- Система менеджмента качества сертифицирована по Международному стандарту ISO 9001;
- При необходимости вся продукция военного и аэрокосмического назначения проходит испытания и сертификацию в лаборатории (по согласованию с заказчиком);
- Поставка специализированных компонентов военного и аэрокосмического уровня качества (Xilinx, Altera, Analog Devices, Intersil, Interpoint, Microsemi, Actel, Aeroflex, Peregrine, VPT, Syfer, Eurofarad, Texas Instruments, MS Kennedy, Miteq, Cobham, E2V, MA-COM, Hittite, Mini-Circuits, General Dynamics и др.);

Компания «Океан Электроники» является официальным дистрибьютором и эксклюзивным представителем в России одного из крупнейших производителей разъемов военного и аэрокосмического назначения «JONHON», а так же официальным дистрибьютором и эксклюзивным представителем в России производителя высокотехнологичных и надежных решений для передачи СВЧ сигналов «FORSTAR».



## JONHON

«JONHON» (основан в 1970 г.)

Разъемы специального, военного и аэрокосмического назначения:

(Применяются в военной, авиационной, аэрокосмической, морской, железнодорожной, горно- и нефтедобывающей отраслях промышленности)

«FORSTAR» (основан в 1998 г.)

ВЧ соединители, коаксиальные кабели, кабельные сборки и микроволновые компоненты:

(Применяются в телекоммуникациях гражданского и специального назначения, в средствах связи, РЛС, а так же военной, авиационной и аэрокосмической отраслях промышленности).



Телефон: 8 (812) 309-75-97 (многоканальный)

Факс: 8 (812) 320-03-32

Электронная почта: [ocean@oceanchips.ru](mailto:ocean@oceanchips.ru)

Web: <http://oceanchips.ru/>

Адрес: 198099, г. Санкт-Петербург, ул. Калинина, д. 2, корп. 4, лит. А