



## GaAs PHEMT MEDIUM POWER AMPLIFIER, 17 - 24 GHz

### Typical Applications

The HMC498LC4 is ideal for use as a LNA or Driver amplifier for:

- Point-to-Point Radios
- Point-to-Multi-Point Radios & VSAT
- Test Equipment & Sensors
- Military End-Use

### Features

- Output IP3: +36 dBm
- Saturated Power: +26 dBm @ 23% PAE
- Gain: 22 dB
- +5V @ 250 mA Supply
- 50 Ohm Matched Input/Output
- RoHS Compliant 4x4 mm SMT Package

### Functional Diagram

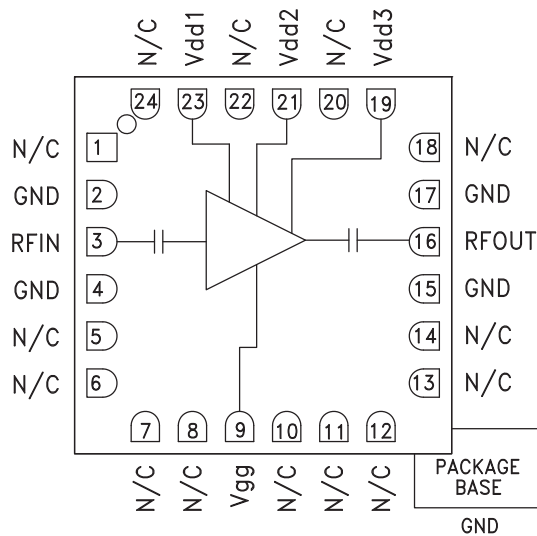

### General Description

The HMC498LC4 is a high dynamic range GaAs PHEMT MMIC Medium Power Amplifier housed in a leadless "Pb free" SMT package. Operating from 17 to 24 GHz, the amplifier provides 22 dB of gain, +26 dBm of saturated power and 23% PAE from a +5V supply voltage. Noise figure is 4 dB while output IP3 is +36 dBm typical enabling the HMC498LC4 to function as a low noise front end as well as a driver amplifier. The RF I/Os are DC blocked and matched to 50 Ohms for ease of use. The HMC498LC4 eliminates the need for wire bonding, allowing use of surface mount manufacturing techniques.

### Electrical Specifications, $T_A = +25^\circ C$ , $V_{dd1, 2, 3} = 5V$ , $I_{dd} = 250 mA^*$

Parameter	Min.	Typ.	Max.	Min.	Typ.	Max.	Min.	Typ.	Max.	Units
Frequency Range	17 - 19			19 - 23			23 - 24			GHz
Gain	18	22		20	22.5		18	21		dB
Gain Variation Over Temperature		0.02	0.03		0.02	0.03		0.02	0.03	dB/ °C
Input Return Loss		13			13			10		dB
Output Return Loss		15			15			20		dB
Output Power for 1 dB Compression (P1dB)	22	25		21.5	24.5		22.5	25.5		dBm
Saturated Output Power (Psat)		26.5			25.5			26.5		dBm
Output Third Order Intercept (IP3)		35			36			35.5		dBm
Noise Figure		4.0			4.0			4.5		dB
Supply Current (I <sub>dd</sub> )(V <sub>dd</sub> = +5V, V <sub>gg</sub> = -0.8V Typ.)		250			250			250		mA

\* Adjust V<sub>gg</sub> between -2 to 0V to achieve I<sub>dd</sub> = 250 mA typical.



**GaAs PHEMT MEDIUM  
POWER AMPLIFIER, 17 - 24 GHz**

**Broadband Gain & Return Loss**

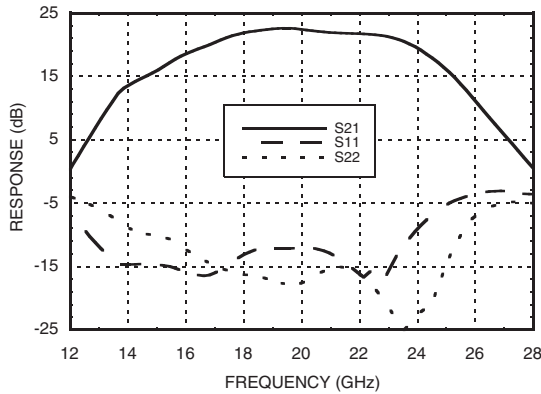

**Gain vs. Temperature**

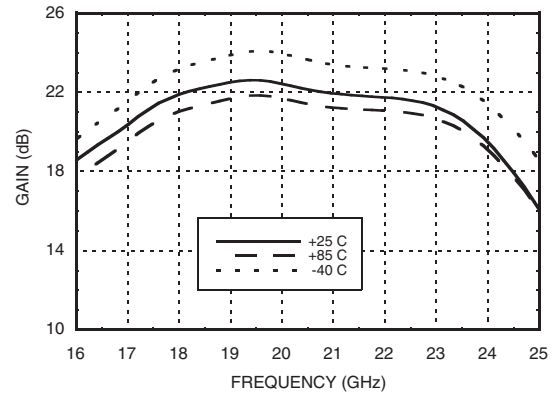

**Input Return Loss vs. Temperature**

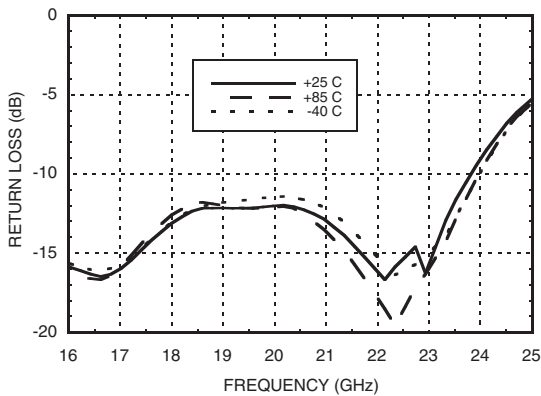

**Output Return Loss vs. Temperature**

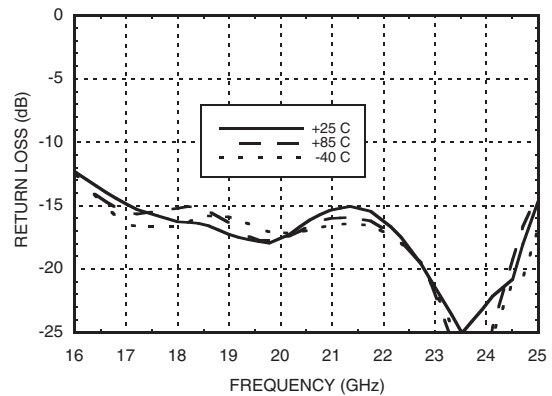

**P1dB vs. Temperature**

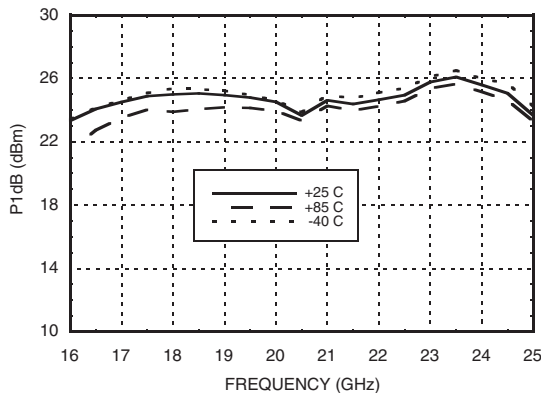

**Psat vs. Temperature**

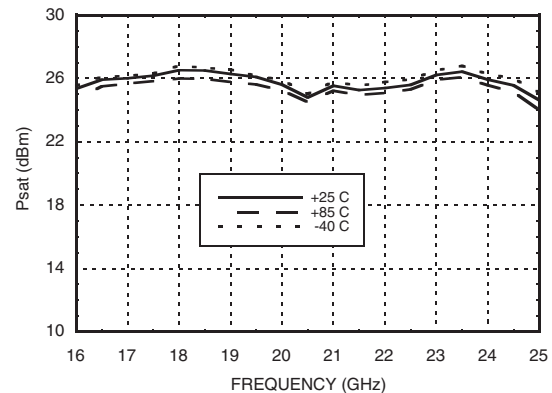

**Output IP3 vs. Temperature**

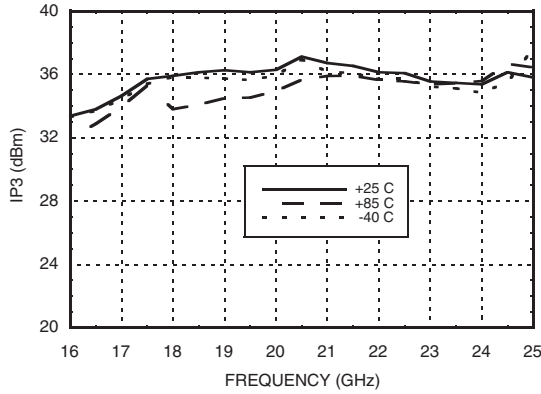

**Noise Figure vs. Temperature**

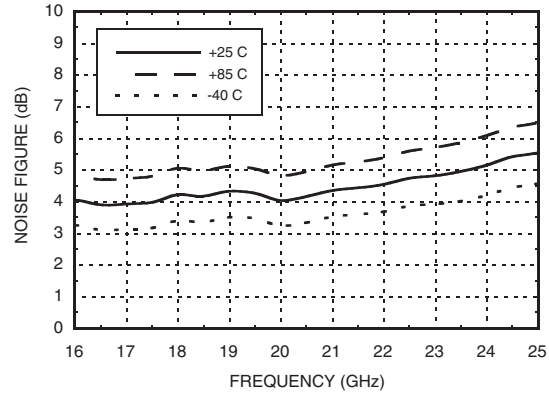

**Gain, Power & OIP3 vs. Supply Voltage @ 23 GHz**

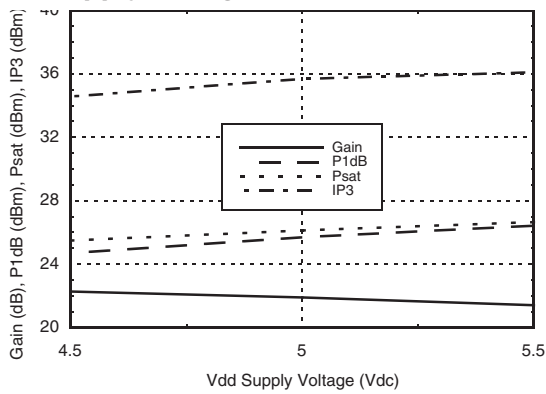

**Reverse Isolation vs. Temperature**

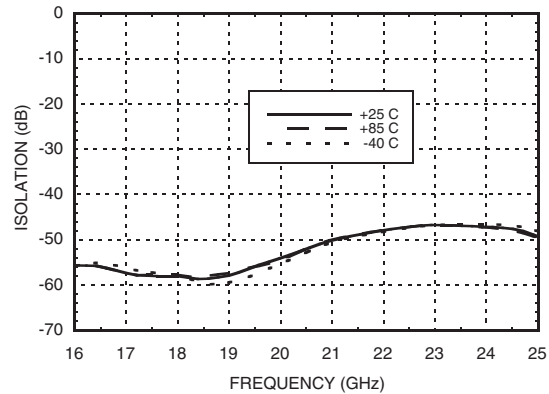

**Power Compression @ 18 GHz**

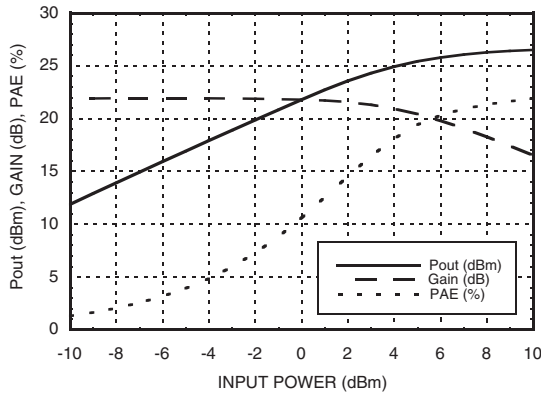

**Power Compression @ 23 GHz**

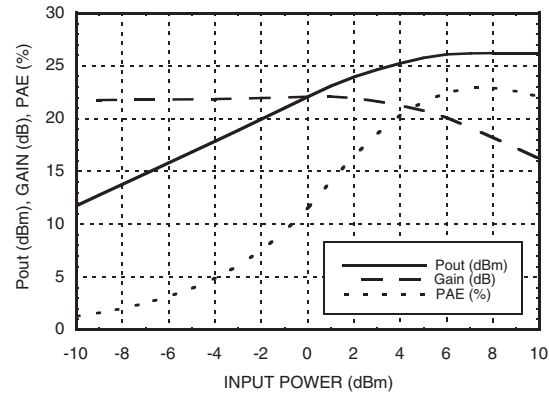

### Absolute Maximum Ratings

Drain Bias Voltage (Vdd1, Vdd2, Vdd3)	+5.5 Vdc
Gate Bias Voltage (Vgg)	-4.0 to 0 Vdc
RF Input Power (RFIN)(Vdd = +5Vdc)	+10 dBm
Channel Temperature	175 °C
Continuous P <sub>diss</sub> (T= 85 °C) (derate 18 mW/°C above 85 °C)	1.62 W
Thermal Resistance (channel to ground paddle)	55.6 °C/W
Storage Temperature	-65 to +150 °C
Operating Temperature	-40 to +85 °C
ESD Sensitivity (HBM)	Class 1A

### Typical Supply Current vs. Vdd

Vdd (Vdc)	I <sub>dd</sub> (mA)
+4.5	239
+5.0	250
+5.5	262

Note: Amplifier will operate over full voltage ranges shown above. V<sub>gg</sub> adjusted to achieve I<sub>dd</sub>= 250 mA at +5V.



ELECTROSTATIC SENSITIVE DEVICE  
OBSERVE HANDLING PRECAUTIONS

11

### Outline Drawing

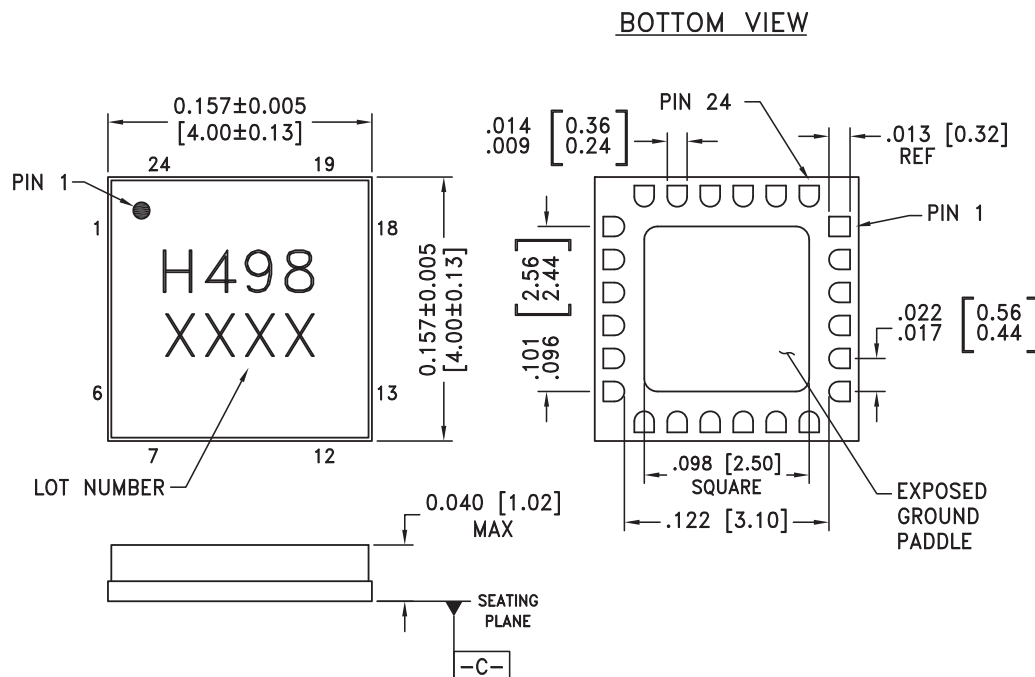



#### NOTES:

1. PACKAGE BODY MATERIAL: ALUMINA.
2. LEAD AND GROUND PADDLE PLATING: GOLD FLASH OVER NICKEL.
3. DIMENSIONS ARE IN INCHES (MILLIMETERS).
4. LEAD SPACING TOLERANCE IS NON-CUMULATIVE.
5. CHARACTERS TO BE HELVETICA MEDIUM, .025 HIGH, BLACK INK, OR LASER MARK LOCATED APPROX. AS SHOWN.
6. PACKAGE WARP SHALL NOT EXCEED 0.05MM DATUM  $\overline{C}$ .
7. ALL GROUND LEADS AND GROUND PADDLE MUST BE SOLDERED TO PCB RF GROUND.

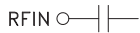
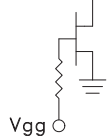
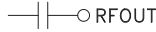

### Pin Descriptions

Pin Number	Function	Description	Interface Schematic
1, 5 - 8, 10 - 14, 18, 20, 22, 24	N/C	No connection required. These pins may be connected to RF/DC ground without affecting performance.	
2, 4, 15, 17	GND	Package bottom has an exposed metal paddle that must also be connected to RF/DC ground.	
3	RFIN	This pin is AC coupled and matched to 50 Ohms.	
9	Vgg	Gate control for amplifier. Adjust to achieve Id of 250 mA. Please follow "MMIC Amplifier Biasing Procedure" Application Note. External bypass capacitors of 100 pF, 1000 pF and 2.2 μF are required.	
16	RFOUT	This pin is AC coupled and matched to 50 Ohms.	
23, 21, 19	Vdd1, Vdd2, Vdd3	Power Supply Voltage for the amplifier. External bypass capacitors of 100 pF, 1000pF, and 2.2 μF are required.	

### Evaluation PCB

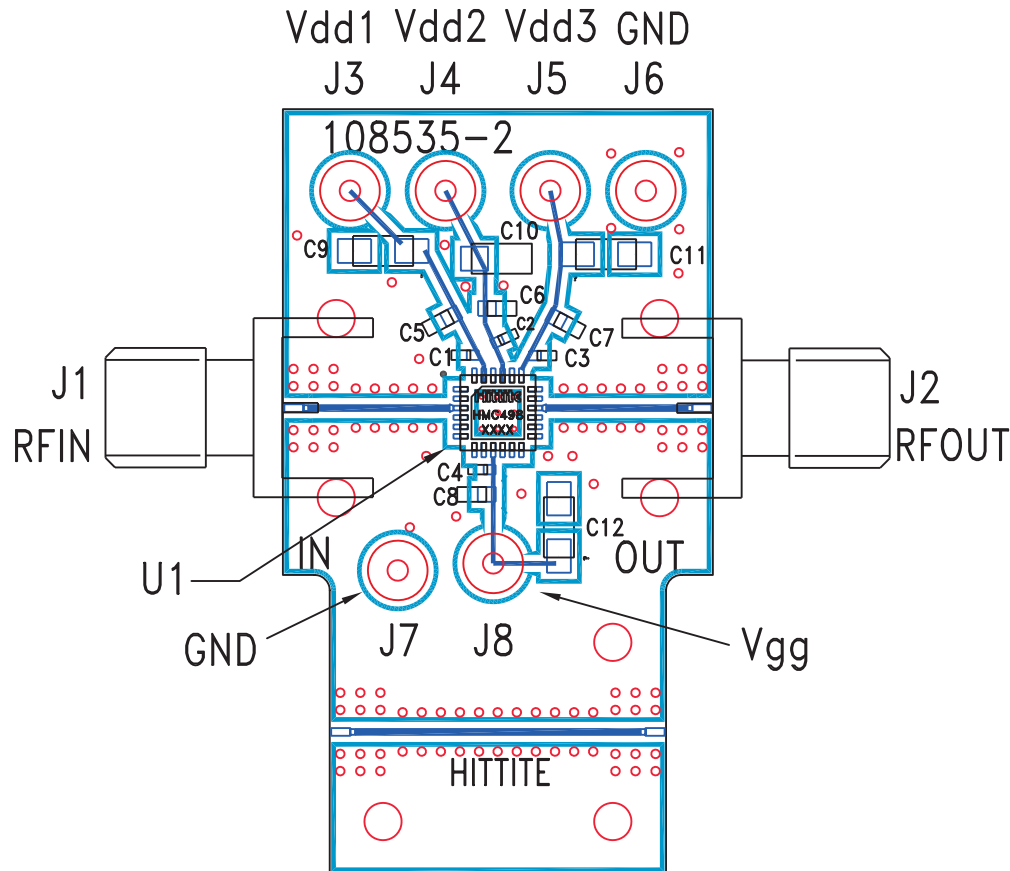

### List of Materials for Evaluation PCB 108537 <sup>[1]</sup>

Item	Description
J1, J2	2.92 mm PC mount K-connector
J3 - J8	DC Pin
C1 - C4	100 pF capacitor, 0402 pkg.
C5 - C8	1,000 pF Capacitor, 0603 pkg.
C9 - C12	2.2μF Capacitor, Tantalum
U1	HMC498LC4 Amplifier
PCB <sup>[2]</sup>	108535 Evaluation PCB

[1] Reference this number when ordering complete evaluation PCB

[2] Circuit Board Material: Rogers 4350.

The circuit board used in this application should use RF circuit design techniques. Signal lines should have 50 ohm impedance while the package ground leads and exposed paddle should be connected directly to the ground plane similar to that shown. A sufficient number of via holes should be used to connect the top and bottom ground planes. The evaluation board should be mounted to an appropriate heat sink. The evaluation circuit board shown is available from Hittite upon request.

Компания «Океан Электроники» предлагает заключение долгосрочных отношений при поставках импортных электронных компонентов на взаимовыгодных условиях!

Наши преимущества:

- Поставка оригинальных импортных электронных компонентов напрямую с производств Америки, Европы и Азии, а так же с крупнейших складов мира;
- Широкая линейка поставок активных и пассивных импортных электронных компонентов (более 30 млн. наименований);
- Поставка сложных, дефицитных, либо снятых с производства позиций;
- Оперативные сроки поставки под заказ (от 5 рабочих дней);
- Экспресс доставка в любую точку России;
- Помощь Конструкторского Отдела и консультации квалифицированных инженеров;
- Техническая поддержка проекта, помощь в подборе аналогов, поставка прототипов;
- Поставка электронных компонентов под контролем ВП;
- Система менеджмента качества сертифицирована по Международному стандарту ISO 9001;
- При необходимости вся продукция военного и аэрокосмического назначения проходит испытания и сертификацию в лаборатории (по согласованию с заказчиком);
- Поставка специализированных компонентов военного и аэрокосмического уровня качества (Xilinx, Altera, Analog Devices, Intersil, Interpoint, Microsemi, Actel, Aeroflex, Peregrine, VPT, Syfer, Eurofarad, Texas Instruments, MS Kennedy, Miteq, Cobham, E2V, MA-COM, Hittite, Mini-Circuits, General Dynamics и др.);

Компания «Океан Электроники» является официальным дистрибьютором и эксклюзивным представителем в России одного из крупнейших производителей разъемов военного и аэрокосмического назначения «JONHON», а так же официальным дистрибьютором и эксклюзивным представителем в России производителя высокотехнологичных и надежных решений для передачи СВЧ сигналов «FORSTAR».



## JONHON

«JONHON» (основан в 1970 г.)

Разъемы специального, военного и аэрокосмического назначения:

(Применяются в военной, авиационной, аэрокосмической, морской, железнодорожной, горно- и нефтедобывающей отраслях промышленности)

«FORSTAR» (основан в 1998 г.)

ВЧ соединители, коаксиальные кабели, кабельные сборки и микроволновые компоненты:

(Применяются в телекоммуникациях гражданского и специального назначения, в средствах связи, РЛС, а так же военной, авиационной и аэрокосмической отраслях промышленности).



Телефон: 8 (812) 309-75-97 (многоканальный)

Факс: 8 (812) 320-03-32

Электронная почта: [ocean@oceanchips.ru](mailto:ocean@oceanchips.ru)

Web: <http://oceanchips.ru/>

Адрес: 198099, г. Санкт-Петербург, ул. Калинина, д. 2, корп. 4, лит. А