

# LM5121EVM Evaluation Module

## User's Guide



Literature Number: SNVU206  
AUGUST 2013

# LM5121EVM Evaluation Module

---



---



---

## 1 Introduction

The LM5121EVM evaluation module (EVM) provides the design engineer with a fully functional synchronous boost converter to evaluate the Texas Instruments LM5121 synchronous boost controller IC. The EVM provides 12 V output at up to 2 A current from a 3 V to 12 V input, and requires 5.7 V for start-up. The EVM is designed to start up from a single power supply without any additional bias voltage.

## 2 Features and Electrical Performance

- 3 V to 12 V input voltage range (5.7 V for start-up)
- 12 V nominal output voltage
- Up to 2.0 A output current
- 250 kHz typical switching frequency
- Configurable light load operation
- Load disconnection
- Inrush current limit
- Short circuit protection
- Circuit breaker
- Easy access to IC pins including RT, SS, UVLO, COMP and RES

**Table 1. Electrical Performance Specifications**

PARAMETER	TEST CONDITIONS	MIN	TYP	MAX	UNITS
<b>Input Characteristics</b>					
Input voltage		3.0 (5.7)	9	12	V
Input current	$V_{\text{SUPPLY}} = 9 \text{ V}$ , $I_{\text{LOAD}} = 2 \text{ A}$		2.7		A
<b>Output Characteristics</b>					
Output voltage	$I_{\text{LOAD}} = 2 \text{ A}$	11.58	12	12.42	V
Output current				2.0	A
<b>System Characteristics</b>					
Switching frequency			250		kHz
Full load efficiency	$V_{\text{SUPPLY}} = 9 \text{ V}$		96		%
	$V_{\text{SUPPLY}} = 12 \text{ V}$		99		%

### 3 Test Points and Jumper

#### 3.1 MODE Setup – J1

LM5121EVM's light load operation can be configured as one of Forced PWM, Skip Cycle or Pulse Skip mode by J1 jumper setting. By placing a jumper shunt on pin 1 and 2, the converter operates in Forced FPWM mode. By placing the jumper shunt on pin 3 and 4, the converter operates in Pulse Skip mode. Skip cycle operation is enabled by not placing any jumper on J1.

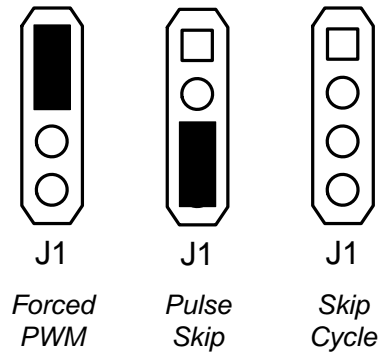

**Figure 1. J1 Jumper Setting**

#### 3.2 Test Points – J2

J2 connector provides convenient access to IC pins. This connector is left unpopulated to use as test points.

**Table 2. J2 Pin Descriptions**

PIN NUMBER	LABEL	DESCRIPTIONS
2	NC	Not used.
4	NC	Not used.
6	SYNC	AC coupled synchronization clock input.
8	RT	RT pin connection. Can be used for synchronization clock input.
10	SS	Soft-start pin connection.
12	UVLO	Under voltage lockout pin connection.
14	COMP	Internal error amplifier output connection.
16	RES	Restart pin connection.
1, 3, 5, 7, 9, 11, 13, 15, 17, 19	Ground	Ground connections

## 4 Test Equipment

### 4.1 Power Supply

Power Supply should be capable of 12 V / 10 A, current monitoring and remote sensing.

### 4.2 Electronic Load

Electronic load should be capable of 15 V / 3 A. Use Constant Current (CC) mode.

### 4.3 Meters

One current meter is required to measure input current accurately. Maximum current rating of the meter should be carefully considered. Input current can be as high as 10 A at full load current and minimum input voltage.

Output voltage is monitored by a voltage meter which should be capable of monitoring up to 15 V

### 4.4 Oscilloscope

Oscilloscope and 10x probe with at least 20 MHz bandwidth are required.

## 5 Test Setup and Procedure

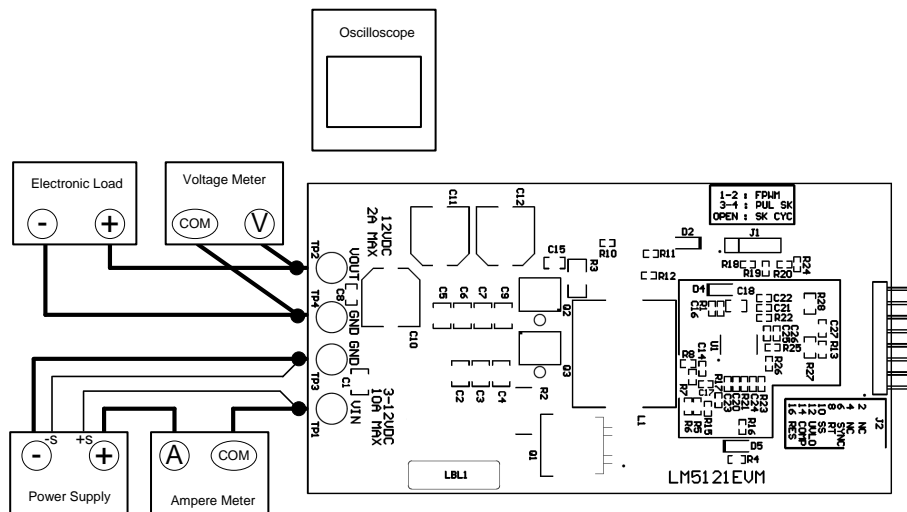

Figure 2. Connection Diagram

### 5.1 Precaution & Wire Gauge

Wire gauge for the input power supply should be 10 AWG minimum and no longer than 1 foot each for VIN and GND. Wire gauge for the output electronic load should be 14 AWG minimum and no longer than 1 foot each for VOUT and GND.

To prevent high-side MOSFET overheating, turn on the load after start-up and turn it off before shutdown.

## 5.2 Test Setup

### 5.2.1 Power Supply

Connect the power supply's positive terminal (+) to 'A' terminal of ampere meter and negative terminal (-) to TP3 GND. Connect the power supply's positive remote sense terminal to TP1 VIN and negative remote sense terminal to TP3 GND.

### 5.2.2 Meter

Connect 'COM' terminal of ampere meter to TP1 VIN. Double check 'A' terminal is connected to the power supply's positive terminal.

Voltage meter is used to measure output voltage. Connect positive terminal (V) of the voltage meter to TP2 VOUT and negative terminal (COM) of the voltage meter to TP4 GND.

### 5.2.3 Load

Connect electronic load's positive terminal (+) to TP2 VOUT and negative terminal (-) to TP4 GND.

## 5.3 Quick Test Procedure

### 5.3.1 Start-Up

- Set load current to 0 A and turn the load on
- Set power supply current limit to 10 A
- Turn on the power supply and increase voltage slowly up to 12 V
- Increase load current slowly up to 2.0 A

### 5.3.2 Shutdown

- Turn off the load
- Decrease the input voltage down to 0 V
- Turn on the load and discharge output capacitor

## 6 Typical Performance Curves

The following curves are presented for reference, the actual field data may differ slightly from these curves. Actual performance data can be affected by measurement techniques, equipment setting and environmental variables.

### 6.1 Efficiency

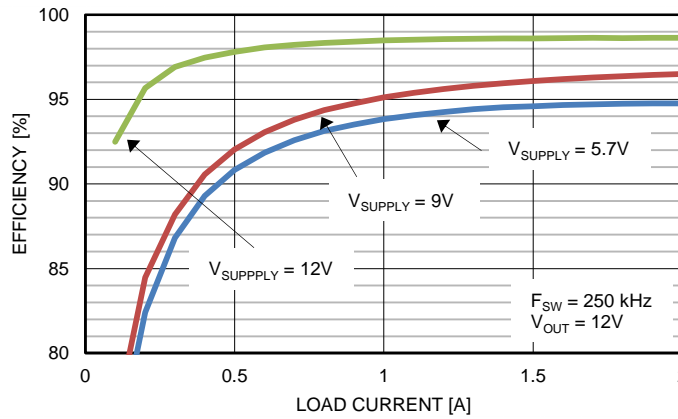

Figure 3. Efficiency (FPWM Mode)

### 6.2 Load Transient

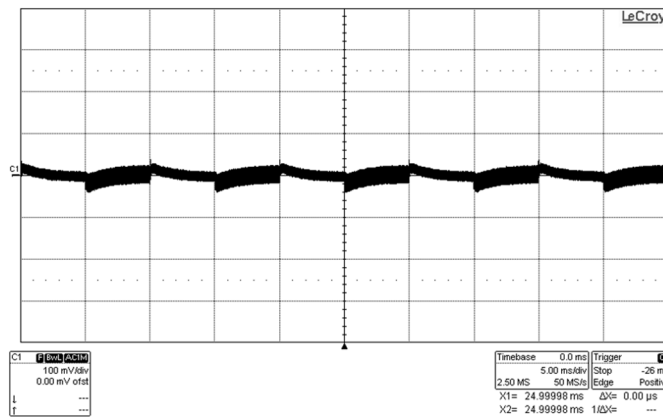

Figure 4. Load Transient

C1: Vout  
 $V_{SUPPLY} = 9\text{ V}$ , 1 A to 2 A and 2 A to 1 A load transient

### 6.3 Clock Synchronization

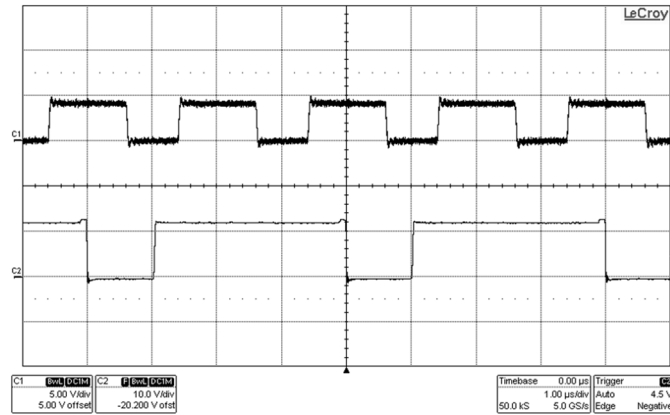

Figure 5. Clock Synchronization

C1:  $F_{\text{SYNC}}$ , C2: SW,  $V_{\text{SUPPLY}} = 9 \text{ V}$ ,  $F_{\text{SYNC}} = 500 \text{ kHz}$

### 6.4 Light Load Operation

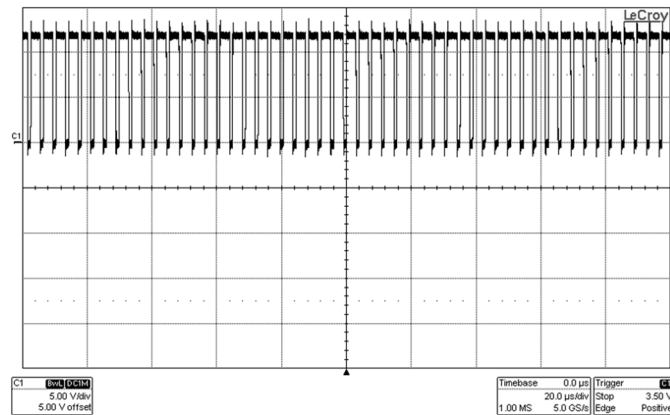

Figure 6. Forced PWM

C1: SW,  $V_{\text{SUPPLY}} = 9 \text{ V}$ ,  $I_{\text{LOAD}} = 0 \text{ A}$

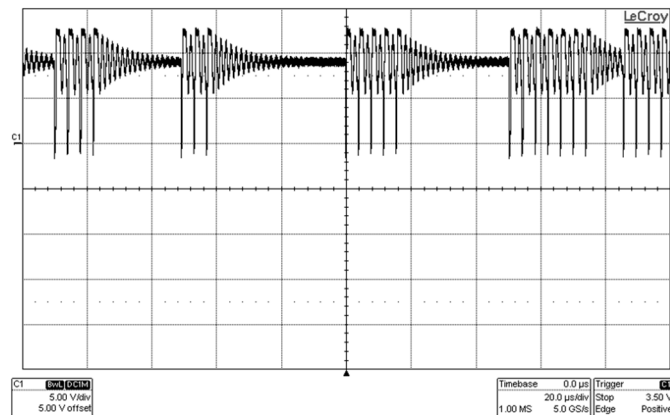

Figure 7. Pulse Skip

C1: SW,  $V_{\text{SUPPLY}} = 9 \text{ V}$ ,  $I_{\text{LOAD}} = 0 \text{ A}$

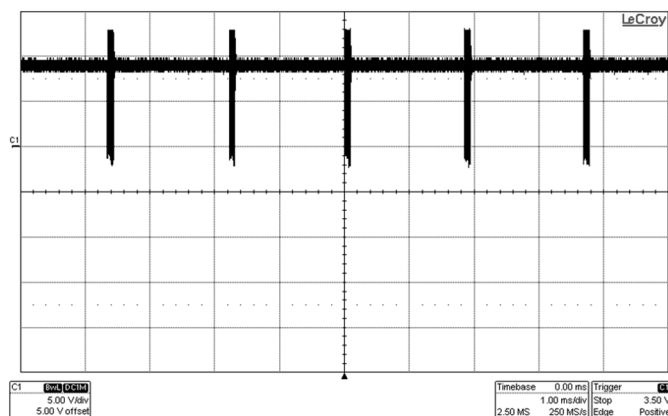

Figure 8. Skip Cycle

C1:SW,  $V_{SUPPLY} = 9\text{ V}$ ,  $I_{LOAD} = 0\text{ A}$

### 6.5 Loop Response

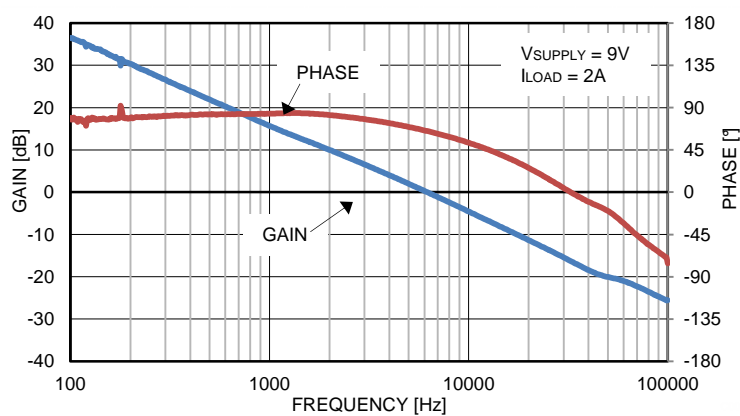
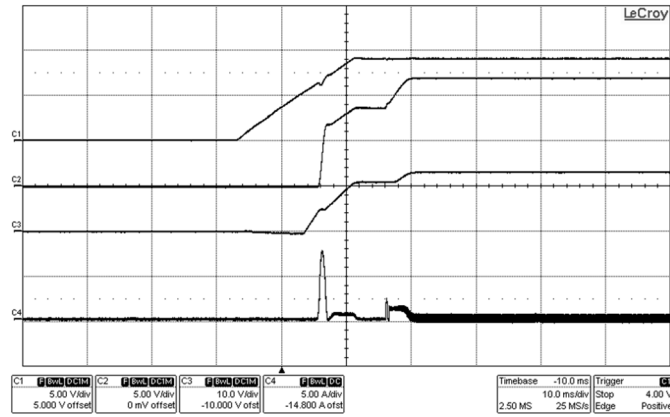

Figure 9. Loop Response



**6.6 Start-up**



**Figure 10. Start-up**

C1:  $V_{SUPPLY}$ , C2:  $V_{OUT}$ , C3:  $V_{DG-DS}$ ,  
 C4: Disconnection Switch Current  $V_{SUPPLY} = 9\text{ V}$ ,  $I_{LOAD} = 0\text{ A}$



## 8 Layout

The LM5121EVM has been designed using a 2-layer board. Most of components are on the top to allow the user to easily view, probe, and evaluate the LM5121 IC.

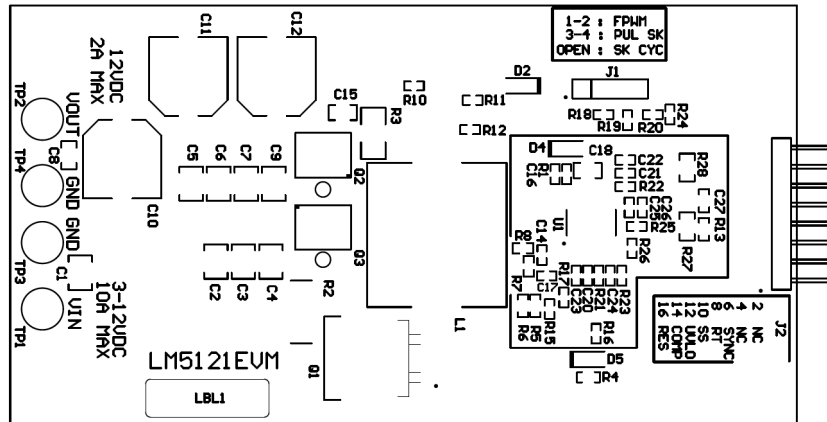

Figure 12. Top Silk (Top View)

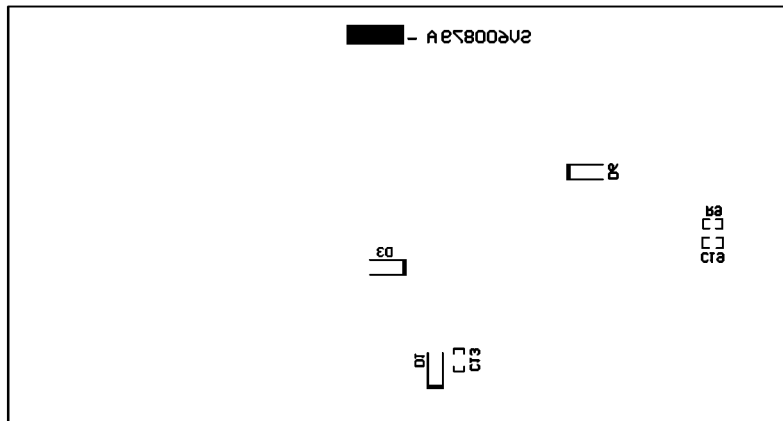

Figure 13. Bottom Silk (X-Ray View)

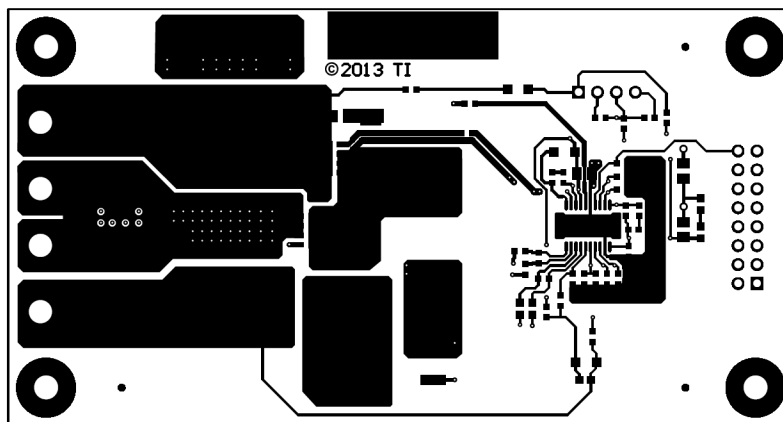

Figure 14. Top Copper (Top View)

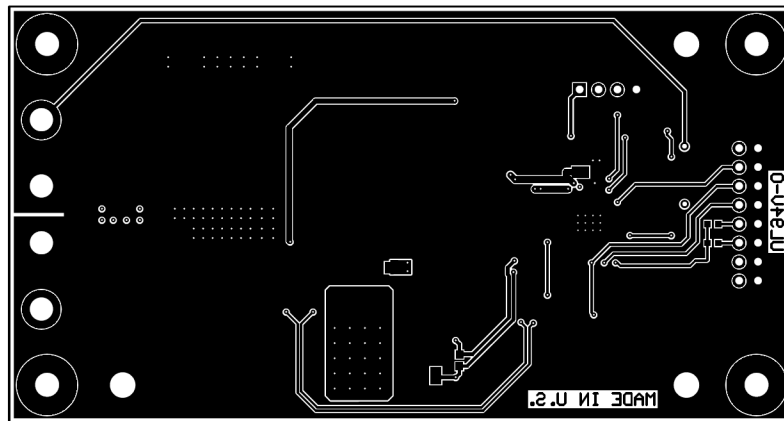

Figure 15. Bottom Copper (X-Ray View)

## 9 Bill of Materials

The EVM components are list according to the schematic shown in [Figure 11](#).

Reference Designator	Description	Manufacturer	Part Number	Qty.
C1, C2, C3, C4	CAP, CERM, 3.3uF, 50V, +/-10%, X7R, 1210	MuRata	GRM32DR71H335KA88L	4
C5, C6, C7, C9	CAP CER 10UF 35V 20% X7R 1210	Taiyo Yuden	GMK325AB7106MM-T	4
C8	CAP, CERM, 1uF, 50V, +/-10%, X7R, 0805	MuRata	GRM21BR71H105KA12L	1
C10, C11, C12	CAP ALUM 330UF 35V 20% SMD	Panasonic	EEE-FP1V331AP	3
C14	CAP, CERM, 100pF, 50V, +/-5%, C0G/NP0, 0603	MuRata	GRM1885C1H101JA01D	1
C15	CAP, CERM, 470pF, 100V, +/-5%, C0G/NP0, 0805	MuRata	GRM2165C2A471JA01D	1
C16	CAP, CERM, 0.1uF, 25V, +10%, X7R, 0603	MuRata	GRM188R71E104KA01D	1
C17, C19, C20, C25	CAP, CERM, 100pF, 50V, +/-5%, C0G/NP0, 0603	MuRata	GRM1885C1H101JA01D	4
C18	CAP, CERM, 4.7uF, 16V, +10%, X7R, 0805	MuRata	GRM21BR71C475KA73L	1
C22	CAP, CERM, 0.18uF, 25V, +/-10%, X7R, 0603	MuRata	GRM188R71E184KA88D	1
C23	CAP, CERM, 0.47uF, 25V, +10%, X7R, 0603	MuRata	GRM188R71E474KA12D	1
C24	CAP, CERM, 0.1uF, 25V, +/-10%, X7R, 0603	MuRata	GRM188R71E104KA01D	1
C26	CAP, CERM, 8200pF, 50V, +/-10%, X7R, 0603	MuRata	GRM188R71H822KA01D	1
R1, R7, R8, R9, R10, R11, R12, R18	RES, 0 ohm, 5%, 0.1W, 0603	Panasonic	ERJ-3GEY0R00V	8
R2	RES 0.007 OHM 3W 1% 3015 WIDE	Susumu	KRL7638-C-R007-F-T1	1
R3	RES 8.2 OHM 3/4W 5% 2010 SMD	Vishay	CRCW20108R20JNEF	1
R5, R6	RES, 100 ohm, 1%, 0.1W, 0603	Vishay	CRCW0603100RFKEA	2
R16	RES, 365k ohm, 1%, 0.1W, 0603	Yageo	RC0603FR-07365KL	1
R17	RES, 3.3 ohm, 5%, 0.1W, 0603	Vishay	CRCW06033R30JNEA	1
R21	RES, 107k ohm, 1%, 0.1W, 0603	Yageo	RC0603FR-07107KL	1
R22	RES, 95.3k ohm, 1%, 0.1W, 0603	Yageo	RC0603FR-0795K3L	1
R23	RES, 36.5k ohm, 1%, 0.1W, 0603	Vishay	CRCW060336K5FKEA	1
R25	RES, 200k ohm, 1%, 0.1W, 0603	Yageo	RC0603FR-07200KL	1
R26	RES, 5.62k ohm, 1%, 0.1W, 0603	Yageo	RC0603FR-075K62L	1
R27	RES, 49.9k ohm, 1%, 0.125W, 0805	Vishay	CRCW080549K9FKEA	1
R28	RES, 681 ohm, 1%, 0.125W, 0805	Vishay	CRCW0805681RFKEA	1
D2, D4, D5	Diode, Schottky, 60V, 1A, SOD-123F	NXP	PMEG6010CEH,115	3
D3	Diode, Schottky, 100V, 1A, PowerDI123	Diodes	DFLS1100-7	1
Q1	MOSFET, N-CH, 75V, 235A, D2PAK	Fairchild	FDB031N08	1
Q2, Q3	MOSFET N-CH 40V 100A LFPAK	NXP	PSMN4R0-40YS,115	2
	MOSFET N-CH 40V 100A SON 5x6	TI	CSD18501Q5A	Alt
L1	SMD Flat Wire Inductor WE-HCl, L=10.0 µH	Würth	74435561100	1
TP1, TP2, TP3, TP4	Terminal, Turret, TH, Double	Keystone	1503-2	4
H1, H2, H3, H4	Machine Screw, Round, #4-40 x 1/4, Nylon	B&F	NY PMS 440 0025 PH	4
H5, H6, H7, H8	Standoff, Hex, 0.5"L #4-40 Nylon	Keystone	1902C	4
J1	Header, TH, 100mil, 4x1, Gold plated	Samtec	TSW-104-07-G-S	1
SH-J1	Shunt, 100mil, Gold plated, Black	3M	969102-0000-DA	1
U1	IC, PWM,Boost Controller	TI	LM5121MH/NOPB	1

## EVALUATION BOARD/KIT/MODULE (EVM) ADDITIONAL TERMS

Texas Instruments (TI) provides the enclosed Evaluation Board/Kit/Module (EVM) under the following conditions:

The user assumes all responsibility and liability for proper and safe handling of the goods. Further, the user indemnifies TI from all claims arising from the handling or use of the goods.

Should this evaluation board/kit not meet the specifications indicated in the User's Guide, the board/kit may be returned within 30 days from the date of delivery for a full refund. THE FOREGOING LIMITED WARRANTY IS THE EXCLUSIVE WARRANTY MADE BY SELLER TO BUYER AND IS IN LIEU OF ALL OTHER WARRANTIES, EXPRESSED, IMPLIED, OR STATUTORY, INCLUDING ANY WARRANTY OF MERCHANTABILITY OR FITNESS FOR ANY PARTICULAR PURPOSE. EXCEPT TO THE EXTENT OF THE INDEMNITY SET FORTH ABOVE, NEITHER PARTY SHALL BE LIABLE TO THE OTHER FOR ANY INDIRECT, SPECIAL, INCIDENTAL, OR CONSEQUENTIAL DAMAGES.

Please read the User's Guide and, specifically, the Warnings and Restrictions notice in the User's Guide prior to handling the product. This notice contains important safety information about temperatures and voltages. For additional information on TI's environmental and/or safety programs, please visit [www.ti.com/esh](http://www.ti.com/esh) or contact TI.

No license is granted under any patent right or other intellectual property right of TI covering or relating to any machine, process, or combination in which such TI products or services might be or are used. TI currently deals with a variety of customers for products, and therefore our arrangement with the user is not exclusive. TI assumes no liability for applications assistance, customer product design, software performance, or infringement of patents or services described herein.

## REGULATORY COMPLIANCE INFORMATION

As noted in the EVM User's Guide and/or EVM itself, this EVM and/or accompanying hardware may or may not be subject to the Federal Communications Commission (FCC) and Industry Canada (IC) rules.

For EVMs **not** subject to the above rules, this evaluation board/kit/module is intended for use for ENGINEERING DEVELOPMENT, DEMONSTRATION OR EVALUATION PURPOSES ONLY and is not considered by TI to be a finished end product fit for general consumer use. It generates, uses, and can radiate radio frequency energy and has not been tested for compliance with the limits of computing devices pursuant to part 15 of FCC or ICES-003 rules, which are designed to provide reasonable protection against radio frequency interference. Operation of the equipment may cause interference with radio communications, in which case the user at his own expense will be required to take whatever measures may be required to correct this interference.

### General Statement for EVMs including a radio

*User Power/Frequency Use Obligations:* This radio is intended for development/professional use only in legally allocated frequency and power limits. Any use of radio frequencies and/or power availability of this EVM and its development application(s) must comply with local laws governing radio spectrum allocation and power limits for this evaluation module. It is the user's sole responsibility to only operate this radio in legally acceptable frequency space and within legally mandated power limitations. Any exceptions to this are strictly prohibited and unauthorized by Texas Instruments unless user has obtained appropriate experimental/development licenses from local regulatory authorities, which is responsibility of user including its acceptable authorization.

### For EVMs annotated as FCC – FEDERAL COMMUNICATIONS COMMISSION Part 15 Compliant

#### Caution

This device complies with part 15 of the FCC Rules. Operation is subject to the following two conditions: (1) This device may not cause harmful interference, and (2) this device must accept any interference received, including interference that may cause undesired operation.

Changes or modifications not expressly approved by the party responsible for compliance could void the user's authority to operate the equipment.

### FCC Interference Statement for Class A EVM devices

This equipment has been tested and found to comply with the limits for a Class A digital device, pursuant to part 15 of the FCC Rules. These limits are designed to provide reasonable protection against harmful interference when the equipment is operated in a commercial environment. This equipment generates, uses, and can radiate radio frequency energy and, if not installed and used in accordance with the instruction manual, may cause harmful interference to radio communications. Operation of this equipment in a residential area is likely to cause harmful interference in which case the user will be required to correct the interference at his own expense.

### **FCC Interference Statement for Class B EVM devices**

This equipment has been tested and found to comply with the limits for a Class B digital device, pursuant to part 15 of the FCC Rules. These limits are designed to provide reasonable protection against harmful interference in a residential installation. This equipment generates, uses and can radiate radio frequency energy and, if not installed and used in accordance with the instructions, may cause harmful interference to radio communications. However, there is no guarantee that interference will not occur in a particular installation. If this equipment does cause harmful interference to radio or television reception, which can be determined by turning the equipment off and on, the user is encouraged to try to correct the interference by one or more of the following measures:

- Reorient or relocate the receiving antenna.
- Increase the separation between the equipment and receiver.
- Connect the equipment into an outlet on a circuit different from that to which the receiver is connected.
- Consult the dealer or an experienced radio/TV technician for help.

### **For EVMs annotated as IC – INDUSTRY CANADA Compliant**

This Class A or B digital apparatus complies with Canadian ICES-003.

Changes or modifications not expressly approved by the party responsible for compliance could void the user's authority to operate the equipment.

### **Concerning EVMs including radio transmitters**

This device complies with Industry Canada licence-exempt RSS standard(s). Operation is subject to the following two conditions: (1) this device may not cause interference, and (2) this device must accept any interference, including interference that may cause undesired operation of the device.

### **Concerning EVMs including detachable antennas**

Under Industry Canada regulations, this radio transmitter may only operate using an antenna of a type and maximum (or lesser) gain approved for the transmitter by Industry Canada. To reduce potential radio interference to other users, the antenna type and its gain should be so chosen that the equivalent isotropically radiated power (e.i.r.p.) is not more than that necessary for successful communication.

This radio transmitter has been approved by Industry Canada to operate with the antenna types listed in the user guide with the maximum permissible gain and required antenna impedance for each antenna type indicated. Antenna types not included in this list, having a gain greater than the maximum gain indicated for that type, are strictly prohibited for use with this device.

Cet appareil numérique de la classe A ou B est conforme à la norme NMB-003 du Canada.

Les changements ou les modifications pas expressément approuvés par la partie responsable de la conformité ont pu vider l'autorité de l'utilisateur pour actionner l'équipement.

### **Concernant les EVMs avec appareils radio**

Le présent appareil est conforme aux CNR d'Industrie Canada applicables aux appareils radio exempts de licence. L'exploitation est autorisée aux deux conditions suivantes : (1) l'appareil ne doit pas produire de brouillage, et (2) l'utilisateur de l'appareil doit accepter tout brouillage radioélectrique subi, même si le brouillage est susceptible d'en compromettre le fonctionnement.

### **Concernant les EVMs avec antennes détachables**

Conformément à la réglementation d'Industrie Canada, le présent émetteur radio peut fonctionner avec une antenne d'un type et d'un gain maximal (ou inférieur) approuvé pour l'émetteur par Industrie Canada. Dans le but de réduire les risques de brouillage radioélectrique à l'intention des autres utilisateurs, il faut choisir le type d'antenne et son gain de sorte que la puissance isotrope rayonnée équivalente (p.i.r.e.) ne dépasse pas l'intensité nécessaire à l'établissement d'une communication satisfaisante.

Le présent émetteur radio a été approuvé par Industrie Canada pour fonctionner avec les types d'antenne énumérés dans le manuel d'usage et ayant un gain admissible maximal et l'impédance requise pour chaque type d'antenne. Les types d'antenne non inclus dans cette liste, ou dont le gain est supérieur au gain maximal indiqué, sont strictement interdits pour l'exploitation de l'émetteur.

## **【Important Notice for Users of EVMs for RF Products in Japan】**

**This development kit is NOT certified as Confirming to Technical Regulations of Radio Law of Japan**

If you use this product in Japan, you are required by Radio Law of Japan to follow the instructions below with respect to this product:

1. Use this product in a shielded room or any other test facility as defined in the notification #173 issued by Ministry of Internal Affairs and Communications on March 28, 2006, based on Sub-section 1.1 of Article 6 of the Ministry's Rule for Enforcement of Radio Law of Japan,
2. Use this product only after you obtained the license of Test Radio Station as provided in Radio Law of Japan with respect to this product, or
3. Use of this product only after you obtained the Technical Regulations Conformity Certification as provided in Radio Law of Japan with respect to this product. Also, please do not transfer this product, unless you give the same notice above to the transferee. Please note that if you could not follow the instructions above, you will be subject to penalties of Radio Law of Japan.

**Texas Instruments Japan Limited**  
**(address) 24-1, Nishi-Shinjuku 6 chome, Shinjuku-ku, Tokyo, Japan**

<http://www.tij.co.jp>

### **【無線電波を送信する製品の開発キットをお使いになる際の注意事項】**

本開発キットは技術基準適合証明を受けておりません。

本製品のご使用に際しては、電波法遵守のため、以下のいずれかの措置を取っていただく必要がありますのでご注意ください。

1. 電波法施行規則第6条第1項第1号に基づく平成18年3月28日総務省告示第173号で定められた電波暗室等の試験設備でご使用いただく。
2. 実験局の免許を取得後ご使用いただく。
3. 技術基準適合証明を取得後ご使用いただく。

なお、本製品は、上記の「ご使用にあたっての注意」を譲渡先、移転先に通知しない限り、譲渡、移転できないものとします。

上記を遵守頂けない場合は、電波法の罰則が適用される可能性があることをご留意ください。

日本テキサス・インスツルメンツ株式会社  
東京都新宿区西新宿 6 丁目 2 4 番 1 号  
西新宿三井ビル

<http://www.tij.co.jp>



## **EVALUATION BOARD/KIT/MODULE (EVM) WARNINGS, RESTRICTIONS AND DISCLAIMERS**

**For Feasibility Evaluation Only, in Laboratory/Development Environments.** Unless otherwise indicated, this EVM is not a finished electrical equipment and not intended for consumer use. It is intended solely for use for preliminary feasibility evaluation in laboratory/development environments by technically qualified electronics experts who are familiar with the dangers and application risks associated with handling electrical mechanical components, systems and subsystems. It should not be used as all or part of a finished end product.

Your Sole Responsibility and Risk. You acknowledge, represent and agree that:

1. You have unique knowledge concerning Federal, State and local regulatory requirements (including but not limited to Food and Drug Administration regulations, if applicable) which relate to your products and which relate to your use (and/or that of your employees, affiliates, contractors or designees) of the EVM for evaluation, testing and other purposes.
2. You have full and exclusive responsibility to assure the safety and compliance of your products with all such laws and other applicable regulatory requirements, and also to assure the safety of any activities to be conducted by you and/or your employees, affiliates, contractors or designees, using the EVM. Further, you are responsible to assure that any interfaces (electronic and/or mechanical) between the EVM and any human body are designed with suitable isolation and means to safely limit accessible leakage currents to minimize the risk of electrical shock hazard.
3. Since the EVM is not a completed product, it may not meet all applicable regulatory and safety compliance standards (such as UL, CSA, VDE, CE, RoHS and WEEE) which may normally be associated with similar items. You assume full responsibility to determine and/or assure compliance with any such standards and related certifications as may be applicable. You will employ reasonable safeguards to ensure that your use of the EVM will not result in any property damage, injury or death, even if the EVM should fail to perform as described or expected.
4. You will take care of proper disposal and recycling of the EVM's electronic components and packing materials.

**Certain Instructions.** It is important to operate this EVM within TI's recommended specifications and environmental considerations per the user guidelines. Exceeding the specified EVM ratings (including but not limited to input and output voltage, current, power, and environmental ranges) may cause property damage, personal injury or death. If there are questions concerning these ratings please contact a TI field representative prior to connecting interface electronics including input power and intended loads. Any loads applied outside of the specified output range may result in unintended and/or inaccurate operation and/or possible permanent damage to the EVM and/or interface electronics. Please consult the EVM User's Guide prior to connecting any load to the EVM output. If there is uncertainty as to the load specification, please contact a TI field representative. During normal operation, some circuit components may have case temperatures greater than 60°C as long as the input and output are maintained at a normal ambient operating temperature. These components include but are not limited to linear regulators, switching transistors, pass transistors, and current sense resistors which can be identified using the EVM schematic located in the EVM User's Guide. When placing measurement probes near these devices during normal operation, please be aware that these devices may be very warm to the touch. As with all electronic evaluation tools, only qualified personnel knowledgeable in electronic measurement and diagnostics normally found in development environments should use these EVMs.

**Agreement to Defend, Indemnify and Hold Harmless.** You agree to defend, indemnify and hold TI, its licensors and their representatives harmless from and against any and all claims, damages, losses, expenses, costs and liabilities (collectively, "Claims") arising out of or in connection with any use of the EVM that is not in accordance with the terms of the agreement. This obligation shall apply whether Claims arise under law of tort or contract or any other legal theory, and even if the EVM fails to perform as described or expected.

**Safety-Critical or Life-Critical Applications.** If you intend to evaluate the components for possible use in safety critical applications (such as life support) where a failure of the TI product would reasonably be expected to cause severe personal injury or death, such as devices which are classified as FDA Class III or similar classification, then you must specifically notify TI of such intent and enter into a separate Assurance and Indemnity Agreement.

Mailing Address: Texas Instruments, Post Office Box 655303, Dallas, Texas 75265  
Copyright © 2013, Texas Instruments Incorporated

## IMPORTANT NOTICE

Texas Instruments Incorporated and its subsidiaries (TI) reserve the right to make corrections, enhancements, improvements and other changes to its semiconductor products and services per JESD46, latest issue, and to discontinue any product or service per JESD48, latest issue. Buyers should obtain the latest relevant information before placing orders and should verify that such information is current and complete. All semiconductor products (also referred to herein as "components") are sold subject to TI's terms and conditions of sale supplied at the time of order acknowledgment.

TI warrants performance of its components to the specifications applicable at the time of sale, in accordance with the warranty in TI's terms and conditions of sale of semiconductor products. Testing and other quality control techniques are used to the extent TI deems necessary to support this warranty. Except where mandated by applicable law, testing of all parameters of each component is not necessarily performed.

TI assumes no liability for applications assistance or the design of Buyers' products. Buyers are responsible for their products and applications using TI components. To minimize the risks associated with Buyers' products and applications, Buyers should provide adequate design and operating safeguards.

TI does not warrant or represent that any license, either express or implied, is granted under any patent right, copyright, mask work right, or other intellectual property right relating to any combination, machine, or process in which TI components or services are used. Information published by TI regarding third-party products or services does not constitute a license to use such products or services or a warranty or endorsement thereof. Use of such information may require a license from a third party under the patents or other intellectual property of the third party, or a license from TI under the patents or other intellectual property of TI.

Reproduction of significant portions of TI information in TI data books or data sheets is permissible only if reproduction is without alteration and is accompanied by all associated warranties, conditions, limitations, and notices. TI is not responsible or liable for such altered documentation. Information of third parties may be subject to additional restrictions.

Resale of TI components or services with statements different from or beyond the parameters stated by TI for that component or service voids all express and any implied warranties for the associated TI component or service and is an unfair and deceptive business practice. TI is not responsible or liable for any such statements.

Buyer acknowledges and agrees that it is solely responsible for compliance with all legal, regulatory and safety-related requirements concerning its products, and any use of TI components in its applications, notwithstanding any applications-related information or support that may be provided by TI. Buyer represents and agrees that it has all the necessary expertise to create and implement safeguards which anticipate dangerous consequences of failures, monitor failures and their consequences, lessen the likelihood of failures that might cause harm and take appropriate remedial actions. Buyer will fully indemnify TI and its representatives against any damages arising out of the use of any TI components in safety-critical applications.

In some cases, TI components may be promoted specifically to facilitate safety-related applications. With such components, TI's goal is to help enable customers to design and create their own end-product solutions that meet applicable functional safety standards and requirements. Nonetheless, such components are subject to these terms.

No TI components are authorized for use in FDA Class III (or similar life-critical medical equipment) unless authorized officers of the parties have executed a special agreement specifically governing such use.

Only those TI components which TI has specifically designated as military grade or "enhanced plastic" are designed and intended for use in military/aerospace applications or environments. Buyer acknowledges and agrees that any military or aerospace use of TI components which have **not** been so designated is solely at the Buyer's risk, and that Buyer is solely responsible for compliance with all legal and regulatory requirements in connection with such use.

TI has specifically designated certain components as meeting ISO/TS16949 requirements, mainly for automotive use. In any case of use of non-designated products, TI will not be responsible for any failure to meet ISO/TS16949.

### Products

Audio	<a href="http://www.ti.com/audio">www.ti.com/audio</a>
Amplifiers	<a href="http://amplifier.ti.com">amplifier.ti.com</a>
Data Converters	<a href="http://dataconverter.ti.com">dataconverter.ti.com</a>
DLP® Products	<a href="http://www.dlp.com">www.dlp.com</a>
DSP	<a href="http://dsp.ti.com">dsp.ti.com</a>
Clocks and Timers	<a href="http://www.ti.com/clocks">www.ti.com/clocks</a>
Interface	<a href="http://interface.ti.com">interface.ti.com</a>
Logic	<a href="http://logic.ti.com">logic.ti.com</a>
Power Mgmt	<a href="http://power.ti.com">power.ti.com</a>
Microcontrollers	<a href="http://microcontroller.ti.com">microcontroller.ti.com</a>
RFID	<a href="http://www.ti-rfid.com">www.ti-rfid.com</a>
OMAP Applications Processors	<a href="http://www.ti.com/omap">www.ti.com/omap</a>
Wireless Connectivity	<a href="http://www.ti.com/wirelessconnectivity">www.ti.com/wirelessconnectivity</a>

### Applications

Automotive and Transportation	<a href="http://www.ti.com/automotive">www.ti.com/automotive</a>
Communications and Telecom	<a href="http://www.ti.com/communications">www.ti.com/communications</a>
Computers and Peripherals	<a href="http://www.ti.com/computers">www.ti.com/computers</a>
Consumer Electronics	<a href="http://www.ti.com/consumer-apps">www.ti.com/consumer-apps</a>
Energy and Lighting	<a href="http://www.ti.com/energy">www.ti.com/energy</a>
Industrial	<a href="http://www.ti.com/industrial">www.ti.com/industrial</a>
Medical	<a href="http://www.ti.com/medical">www.ti.com/medical</a>
Security	<a href="http://www.ti.com/security">www.ti.com/security</a>
Space, Avionics and Defense	<a href="http://www.ti.com/space-avionics-defense">www.ti.com/space-avionics-defense</a>
Video and Imaging	<a href="http://www.ti.com/video">www.ti.com/video</a>

### TI E2E Community

[e2e.ti.com](http://e2e.ti.com)

Компания «Океан Электроники» предлагает заключение долгосрочных отношений при поставках импортных электронных компонентов на взаимовыгодных условиях!

Наши преимущества:

- Поставка оригинальных импортных электронных компонентов напрямую с производств Америки, Европы и Азии, а так же с крупнейших складов мира;
- Широкая линейка поставок активных и пассивных импортных электронных компонентов (более 30 млн. наименований);
- Поставка сложных, дефицитных, либо снятых с производства позиций;
- Оперативные сроки поставки под заказ (от 5 рабочих дней);
- Экспресс доставка в любую точку России;
- Помощь Конструкторского Отдела и консультации квалифицированных инженеров;
- Техническая поддержка проекта, помощь в подборе аналогов, поставка прототипов;
- Поставка электронных компонентов под контролем ВП;
- Система менеджмента качества сертифицирована по Международному стандарту ISO 9001;
- При необходимости вся продукция военного и аэрокосмического назначения проходит испытания и сертификацию в лаборатории (по согласованию с заказчиком);
- Поставка специализированных компонентов военного и аэрокосмического уровня качества (Xilinx, Altera, Analog Devices, Intersil, Interpoint, Microsemi, Actel, Aeroflex, Peregrine, VPT, Syfer, Eurofarad, Texas Instruments, MS Kennedy, Miteq, Cobham, E2V, MA-COM, Hittite, Mini-Circuits, General Dynamics и др.);

Компания «Океан Электроники» является официальным дистрибьютором и эксклюзивным представителем в России одного из крупнейших производителей разъемов военного и аэрокосмического назначения «JONHON», а так же официальным дистрибьютором и эксклюзивным представителем в России производителя высокотехнологичных и надежных решений для передачи СВЧ сигналов «FORSTAR».



## JONHON

«JONHON» (основан в 1970 г.)

Разъемы специального, военного и аэрокосмического назначения:

(Применяются в военной, авиационной, аэрокосмической, морской, железнодорожной, горно- и нефтедобывающей отраслях промышленности)

«FORSTAR» (основан в 1998 г.)

ВЧ соединители, коаксиальные кабели, кабельные сборки и микроволновые компоненты:

(Применяются в телекоммуникациях гражданского и специального назначения, в средствах связи, РЛС, а так же военной, авиационной и аэрокосмической отраслях промышленности).



Телефон: 8 (812) 309-75-97 (многоканальный)

Факс: 8 (812) 320-03-32

Электронная почта: [ocean@oceanchips.ru](mailto:ocean@oceanchips.ru)

Web: <http://oceanchips.ru/>

Адрес: 198099, г. Санкт-Петербург, ул. Калинина, д. 2, корп. 4, лит. А