

Offers High-speed Input Response of 0.1 ms and Equipped with Built-in Timer



- High-speed response of 0.1 ms.
- Ideal as a two-input Controller.
- Lineup includes the S3D2-BK with flip-flop functions convenient for level control, the S3D2-AKD/CKD/CCD with 24-V power supply, and the S3D2-DK/EK with one input/output OFF-delay (two circuits) useful for load control and lamp display
- Power source for the Sensor can be supplied up to 200 mA.
- Ultra-slim body with 30-mm width.
- Multi-function model equipped with timer functions also available.



 Be sure to read *Safety Precautions* on page 7.

For the most recent information on models that have been certified for safety standards, refer to your OMRON website.

Ordering Information

| Power supply voltage | Output | Timer function | Features | Model |
|----------------------|------------|----------------|---------------------------------------------------------------|------------------|
| 100 to 240 VAC | Relay | No | Single-function with one input/output (two circuits) | S3D2-DK |
| | | Yes | | S3D2-EK |
| | | No | Single-function with two inputs/one output (AND/OR operation) | S3D2-AK * |
| | | Yes | | S3D2-BK |
| | Transistor | Yes | Multi-function with two inputs/one output | S3D2-CK * |
| | | Yes | Multi-function with two inputs/one output | S3D2-CC * |
| 24 VDC | Relay | No | Single-function with two inputs/one output | S3D2-AKD |
| | | Yes | | S3D2-CKD |
| | Transistor | Yes | Multi-function with two inputs/one output | S3D2-CCD |
| | | Yes | | |

* Models compatible with Sensors for PNP connections are also available. These model numbers have the suffix B (e.g., S3D2-AKB)

Differences from NPN Models

| | | |
|---------------|--------------------------------|-----------------------|
| Input signals | ON | 8 to 12 V (2 mA max.) |
| | OFF | 0 to 4 V (5 mA min.) |
| | Maximum applied voltage | 12 V |

Note: S3D2-AK(B)/-CK(B)/-CC(B) models with UL certification are available. These model numbers have the suffix US (e.g., S3D2-AK-US).

Ratings and Specifications

| Type | | Two inputs/ two outputs | | Two inputs/one output | | | | | | |
|----------------------------------------------------------|--------------------------------|------------------------------------------------------------------------------------------------------------------------------------------------------------------------|-------------------------------------------------|--------------------------------------------------------------|-------------------------------------------------------------------------|---------------------------------------------------------------------------------------------------------------------------------|----------------------------------------|----------------------------------------------------------------------------------------------------------------------------------------------------------------------|-------------------------------------------------------------------------------------------------------------------|----------------------------------------------------------------------------------------------------------------------------------|
| | | Single- function | Single-func- tion (with OFF-delay) | Single-func- tion (AND/OR operation) | Flip-flop function | Multi-function | | Single-func- tion (AND/OR operation) | Multi-function (24 VDC) | |
| Item | Model | S3D2-DK | S3D2-EK | S3D2-AK | S3D2-BK | S3D2-CK | S3D2-CC | S3D2-AKD | S3D2-CKD | S3D2-CCD |
| Rated supply voltage | | 100 to 240 VAC ± 10% 50/60Hz | | | | | | 24 VDC ± 10% | | |
| Power consumption | | 15 VA max. | | | | | | 2.5 VA max. (excluding Sensor power supply) | | |
| Power supply for Sensor | | 12 VDC ± 10% (includes all variations), 200 mA max. (with short-circuit protection) | | | | | | 24 VDC (supplied from power supply) | | |
| Connected Sensor | | NPN transistor output (with sinking current of 18 mA min.) or contact output | | | | | | | | |
| Input signals | ON | 0 to 4 V (5 mA min.) | | | | | | | | |
| | OFF | 8 to 12 V (2 mA max.) | | | | | | 8 to 30 V (2 mA max.) | | |
| | Short-circuit current | 11 mA TYP (18 mA max.) | | | | | | | | |
| | Maximum applied voltage | 30 V | | | | | | | | |
| Input response time | | 0.1 ms | | | IN1 2 ms IN2 2 ms | 0.1 ms | | | | |
| Output minimum pulse width | | 10 ms max. | | | | 0.5 ms max. | | 10 ms max. | | 0.5 ms max. |
| Control output | | Relay output SPST-NO × 2 250 VAC, 2A (cosφ = 1) | | Relay output SPDT (shared common) 250 VAC, 3 A (cosφ = 1) | | NPN open collector output, 30 VDC, 100 mA (NO, NC) Residual voltage (ON) 1.5 V max. Leakage current (OFF): 0.1 mA max. | | Relay output SPDT 250 VAC, 3 A (cosφ = 1) | | NPN open collector output, 30 VDC, 100 mA (NO, NC) Residual voltage (ON): 1.5 V max. Leakage current (OFF): 0.1 mA max. |
| Life expectancy (relay output) | Mechanical | 50,000,000 operations min. (switching frequency: 18,000 operations/h) | | | | --- | | 50,000,000 operations min. (switching frequency: 18,000 operations/h) | | --- |
| | Electrical | 100,000 operations min. (switching frequency: 1,800 operations/h) | | | | --- | | 100,000 operations min. (switching frequency: 1,800 operations/h) | | --- |
| Output response time | | 10 ms max. | | | | 0.5 ms max. | | 10 ms max. | | 0.5 ms max. |
| Timer functions * | | --- | OFF-delay 0.1 to 1 s 1 to 10 s selectable | --- | One-shot, ON-delay, and OFF-delay 0.1 to 1 s 1 to 10 s selectable | | 0.01 to 0.1 s 0.1 to 1 s selectable | --- | One-shot, ON-delay, and OFF-delay 0.1 to 1 s 1 to 10 s selectable 0.01 to 0.1 s 0.1 to 1 s selectable | |
| Other functions | | Signal input reverse | | (Output reversible) AND/OR operating mode selection | • Signal input reverse • Flip-flop function | • Signal input reverse • Sync mode selection • AND/OR operating mode selection | | • Signal input reverse • AND/OR operating mode selection | • Signal input reverse • Sync mode selection • AND/OR operating mode selection | |
| Maximum allowable time of momentary power failure | | 20 ms max. | | | | | | | | |
| Ambient temperature range | | Operating: -10 to +55°C, Storage: -25 to +65°C (with no icing) | | | | | | | | |
| Ambient humidity range | | Operating/storage: 35% to 85% | | | | | | | | |
| Noise immunity | | Operating power supply: 1,500 V (p-p) min.; pulse width: 100 ns, 1 μs; rise time: 1 ns Input/output: 1,200 V (p-p) min.; pulse width: 100 ns, 1 μs; rise time: 1 ns | | | | | | Operating power supply: 480 V (p-p) min.; pulse width: 100 ns, 1 μs; rise time: 1 ns Input/output: 1,000 V (p-p) min.; pulse width: 100 ns, 1 μs; rise time: 1 ns | | |
| Dielectric strength | | 1,500 VAC min. (between power supply terminals and I/O terminals, and between non-current-carrying parts) | | | | | | 1,500 VAC min. (between power supply terminals and non-current-carrying parts) | | |
| Vibration (destruction) | | 10 to 55 Hz, double-amplitude of 0.75 mm for 2 hours each of the X, Y, and Z directions | | | | | | | | |
| Weight | | Approx. 140 g | | | | | | | | |

* The timer will not operate in response to input signals received within 50 ms after the Controller power is turned ON.

Output Circuit Diagrams

Note: Numbers in parentheses indicate terminal pin numbers.

Relay Output Model

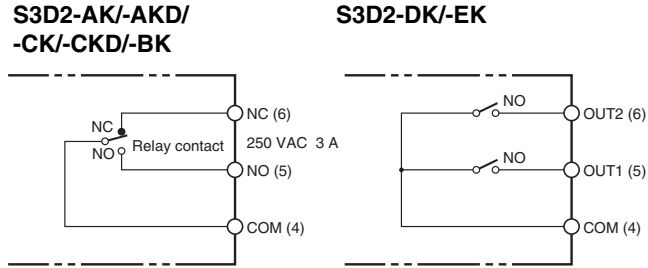

Open Collector Model

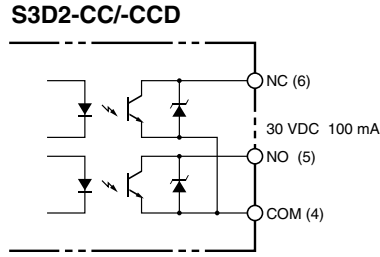

Input Circuit Diagrams

Note: Numbers in parentheses indicate terminal pin numbers.

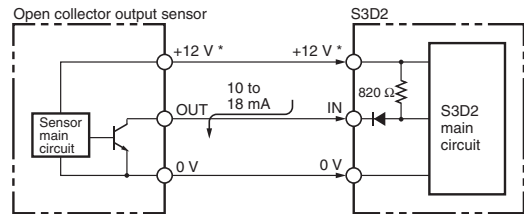
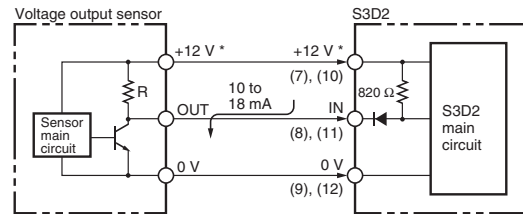

Note: Terminals (7) and (10), and (9) and (12) are connected internally.
* S3D2-AKD/CKD/CCD: +24 V

* S3D2-AKD/CKD/CCD: +24 V

Connections

Connection Methods

S3D2-AK

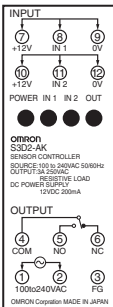

S3D2-AKD

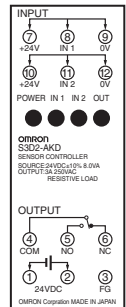

S3D2-CK

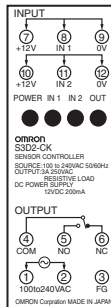

S3D2-CKD

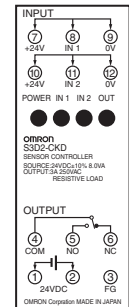

S3D2-CC



S3D2-CCD

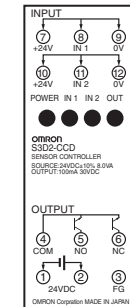

S3D2-BK

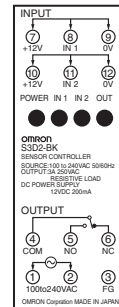

S3D2-DK/EK

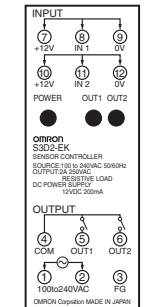

- (1), (2): Power supply terminals
- (3): FG terminal

Ground with a ground resistance of 100 Ω max. in locations subject to excessive noise.

- (4) to (6): Output terminals
- (7), (10): Power supply terminals for S3D2-AKD/CKD/CCD Sensors (+24 V), and other models (+12 V)
- (9), (12): Power supply terminals for the Sensor (0 V)
- (8), (11): Output terminals for the Sensor
Connect the Sensor output lines.

Sensor Connections

Two-wire Sensors (NPN Models)

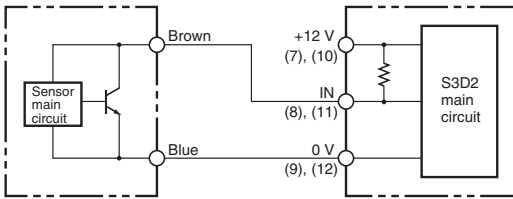

Note: Numbers in parentheses indicate terminal pin numbers.

Contact Output Sensors

- The S3D2 has a high-speed input response of 0.1 ms, which may cause contact output models (relay output, micro-switches, etc.) to receive unnecessary input from contact bounce and chattering.

Example of Unconnectable Sensor Model

| | |
|----------------|-----------------------------------------------------------------------------------------------------------------|
| Type | Proximity Sensor |
| Model | TL-G3D, TL-L100, etc. |
| Details | <p>Sink current of NPN output: 2 mA max. (Sensors that cannot switch 18 mA or higher are unconnectable)</p> |

Wired OR Transistor Output

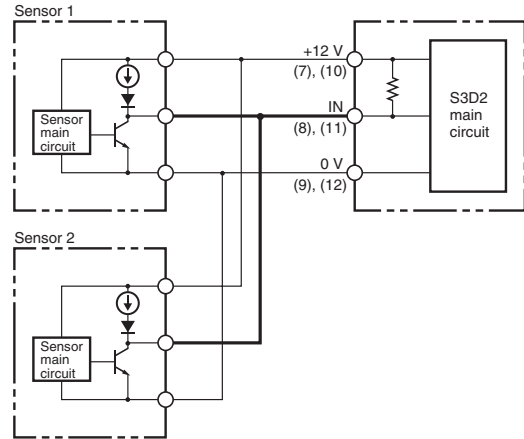

Note: Numbers in parentheses indicate terminal pin numbers.

- Wired OR for "Object Detected" Signals** (e.g., Proximity Sensors with NO Outputs)
The input would be an OR of "object detected" signals using a wired OR of Sensors that turn ON the output transistor when an object is detected. The S3D2's input signal selector switch can be set to reverse this operation and produce an input that would be an AND of "object not detected" signals.
- Wired OR for "Object Not Detected" Signals** (e.g., Proximity Sensors with NC Outputs)
The input would be an OR of "object not detected" signals using a wired OR of Sensors that turn ON the output transistor when an object is not detected. The S3D2's input signal selector switch can be set to reverse this operation and produce an input that would be an AND of "object detected" signals.

Load Connection

Connecting Loads to Collector Side

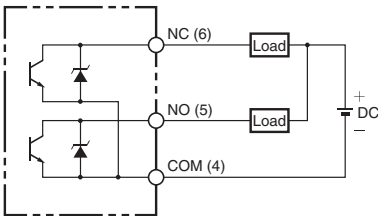

Connecting Loads to Emitter Side

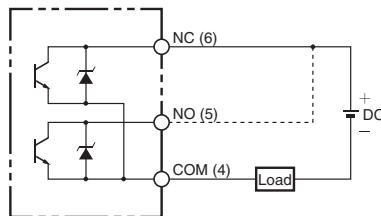

- Note: 1. Numbers in parentheses indicate terminal numbers.
2. Connect either the NC or NO terminals for the Emitter common. The solid line indicates the NC terminal and the broken line indicates the NO terminal.

Nomenclature

S3D2-AK/-AKD

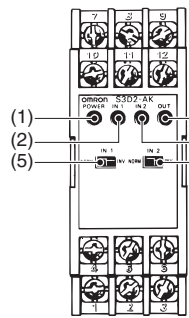

S3D2-CK/-CKD/-CC/-CCD

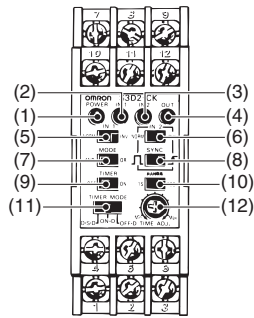

S3D2-BK

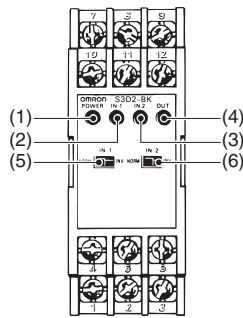

S3D2-DK

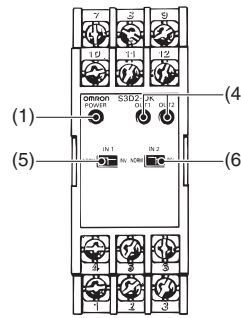

S3D2-EK

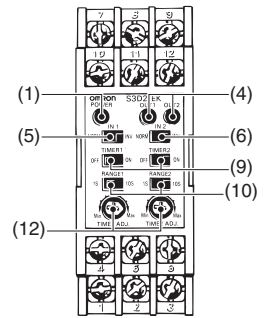

| No. | Name | Functions |
|------|-------------------------------------------------------------------------------------------------------------------------|--------------------------------------------------------------------------------------------------------------------------------------------------------------------------------------------------------------------------------------------------------------------------------------------------------------------------------------------------|
| (1) | POWER indicator (green) | Lights when the operating power is turned ON and the Sensor power supply is output. Not lit when the operating power is turned OFF, or the Sensor power supply is short circuited (between the +12-V or +24-V terminal and 0-V terminal). |
| (2) | IN1 indicator (red) | Lights when the output from the Sensor connected to IN1 is received by IN1 as an input. |
| (3) | IN2 indicator (red) | Lights when the output from the Sensor connected to IN2 is received by IN2 as an input. |
| (4) | OUT indicator (red) | Lights when the output turns ON. |
| (5) | IN1 input signal selector switch | NORM: Input as a signal when the Sensor's output transistor (or contact output) is ON. INV: Input as a signal when the Sensor's output transistor (or contact output) is OFF. |
| (6) | IN2 input signal selector switch | |
| (7) | MODE (AND/OR operation selector switch) | AND: The output is turned ON when IN1 and IN2 input signals are both ON. OR: The output is turned ON when either IN1 or IN2 input signal is ON. |
| (8) | SYNC (synchronous mode selector switch) (This switch is enabled only when the AND/OR operation selector is set to AND.) | : The output is turned ON while both IN1 and IN2 input signals are ON. : If the input signal of IN2 is turned ON (at the rising edge) while the IN1 input signal is ON, the output is turned ON.* |
| (9) | TIMER switch | Turns timer operation ON/OFF. ON: Timer enabled OFF: Timer disabled |
| (10) | RANGE (Timer timing selector switch) | Changes the range for the timer setting time. <ul style="list-style-type: none"> • S3D2-CK/-EK 1 s: Setting time is in range from 0.1 to 1s. 10 s: Setting time is in range from 1 to 10s. • S3D2-CC 0.1 s: Setting time is in range from 0.01 to 0.1s. 1 s: Setting time is in range from 0.1 to 1s. |
| (11) | TIMER MODE (Timer operation mode switch) | O. S: One-shot timer ON. D: ON-delay timer OFF. D: OFF-delay timer |
| (12) | TIME ADJ. (Timer setting adjuster) | Setting time can be adjusted with the provided screwdriver. The adjuster rotates 190°. |

* Be sure to set the one-shot timer.

Operation

Basic Operation

S3D2-AK□: Basic Operation

One Sensor

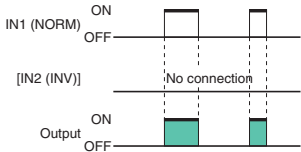

Note: When connecting only one Sensor, be sure to set the input selector switch for the unconnected Sensor to INV.

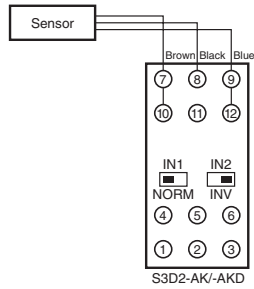

Two Sensors (AND Operation)

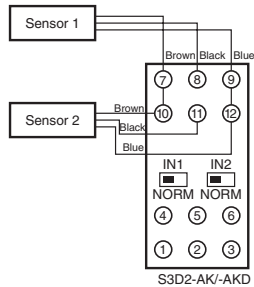
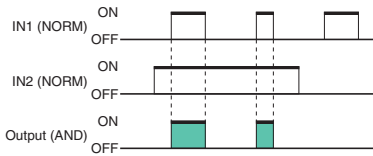

Two Sensors (OR Operation)

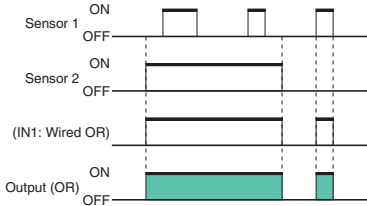

Note: When two Sensors are wired OR and then receive input (IN1 or IN2), OR operation is possible.

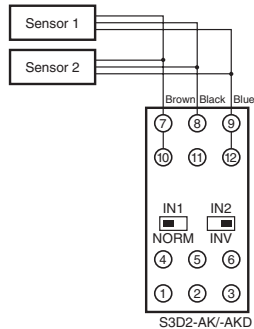

S3D2-AK□ default settings: IN1.....NORM, IN2.....INV.
If AND operation is used, set IN2 to NORM.

S3D2-BK: Flip-flop Operation

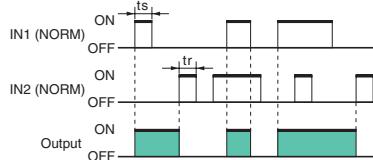

Note: $t_s \geq 2ms$, $t_r \geq 2ms$
Input 1 (IN1) takes priority when both inputs 1 and 2 are received at the same time.

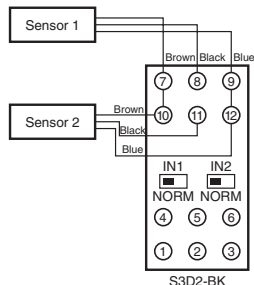

S3D2-CK□/-CC□: Timer Operation (AND)

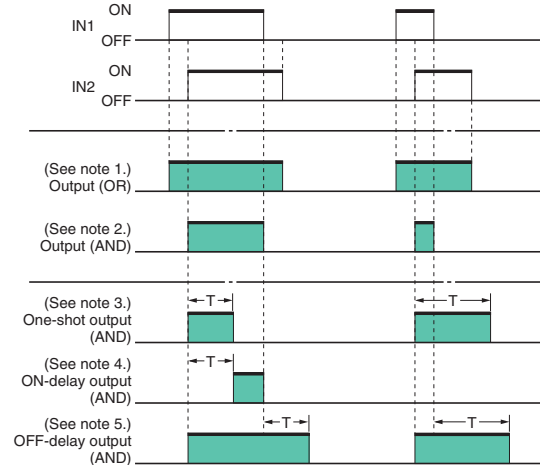

- Note: 1. IN1 and IN2 send OR outputs.
- 2. IN1 and IN2 send AND outputs.
- 3. IN1 and IN2 send AND outputs for T seconds from the rising edge.
- 4. IN1 and IN2 send AND outputs after a delay of T seconds from the rising edge.
- 5. IN1 and IN2 send AND outputs for T seconds from the falling edge.

When only one Sensor is connected to the S3D2-CK□ and S3D2-CC□, always set the AND/OR selector switch to OR

S3D2-DK/-EK: Basic Operation

Two Input Signals Output Independently

The S3D2-EK is equipped with an OFF-delay Timer.

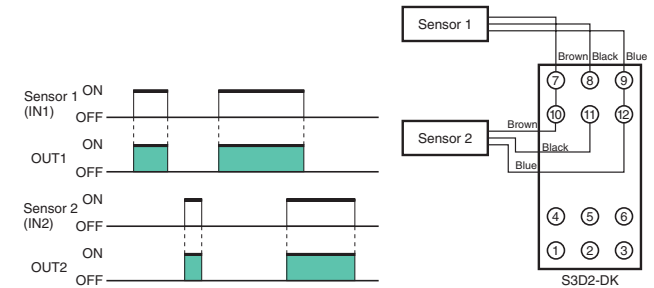

S3D2-DK/-EK: One Sensor with Two Outputs

Terminals (8) and (11) are short-circuited.

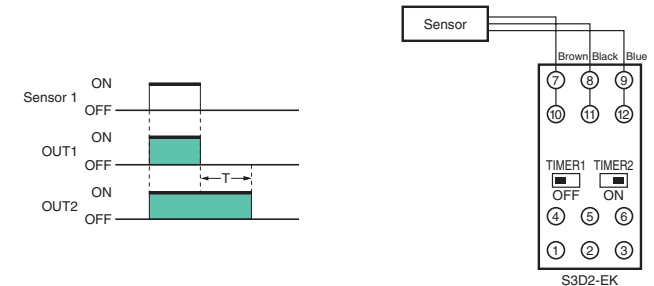

- Note: 1. The time chart above shows the operation for an S3D2-EK when the timer 1 switch is OFF and the timer 2 switch is ON.
- 2. Terminals (8) and (11) are short-circuited, and the current from the S3D2 to the Sensor is $18 \times 2 = 36 \text{ mA}$ max. (TYP 22 mA).

Safety Precautions

Refer to *Warranty and Limitations of Liability*.

⚠ WARNING

This product is not designed or rated for ensuring safety of persons either directly or indirectly. Do not use it for such purposes.



Precautions for Safe Use

- Be sure to connect the power supply to the power supply terminals correctly. Use a power supply with a voltage range of 100 to 240 VAC ± 10%.

Precautions for Correct Use

Do not use the product in atmospheres or environments that exceed product ratings.

● Wiring

Ground

- FG is a ground terminal. Ground this terminal at a ground resistance of 100 Ω max. when installing in locations subject to excessive noise, or if the S3D2 malfunctions.
- Do not share a ground line with other devices, or connect it to a structural beam of a building. Doing so will have the opposite effect, and may adversely affect the Sensor.

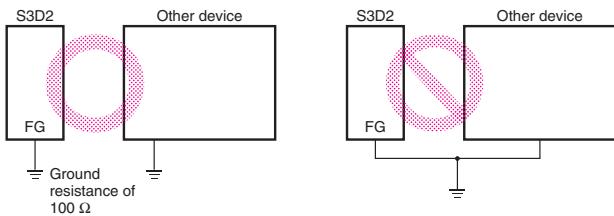

Storing in a Protective Case

- Take measures to provide adequate heat dissipation. Otherwise, heat radiation from the body of the S3D2 may cause the insides of protective casing to heat up.

S3D2-AKD/-CKD/-CCD

- Do not connect a load of 1 A min. to models for which the S3D2 power supply inputs are to be used as is for the Sensor power supply outputs. Connecting a load of 1 A min. to the Sensor's power supply outputs will cause the fuse in the case to break.

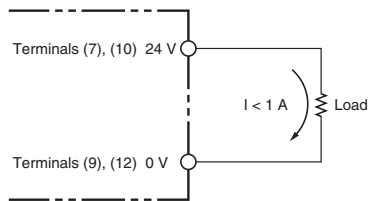

Output

- Connect a surge suppressor or diode in parallel to the load if an inductive load or other electrical part that generates noise is connected to the output.
- Connect the cathode side of the diode to the ⊕ side of the power supply.

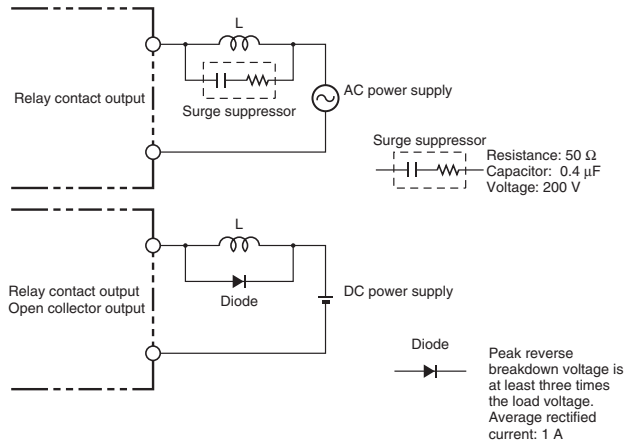

Output Relay Contact

(Not Including S3D2-CC/-CCD/-DK/-EK)

- When using a load (e.g., contactor or valve) that generates an arc when the circuit is broken, the NC (NO) contact may turn ON before the NO (NC) contact has opened (turned OFF).
- When using both NO and NC outputs at the same time, incorporate an arc suppressor (use the CR method, varistor, or other countermeasure).

● Mounting

Tightening Torque

Using the provided M3.5 screws, tighten the terminal block to a torque of 0.59 N·m max.

For direct mounting, use M4 screws, and tighten them to a torque of 0.78 N·m max.

Side-by-side Mounting

- When two or more S3D2 are mounted side by side, be sure to provide a minimum distance of 10 mm between them.

Note: Use the PFP-M End Plate for a space of 10 mm.

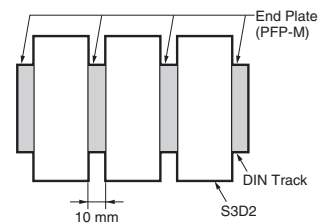

- If side-by-side mounting is unavoidable, refer to the following load derating curve.

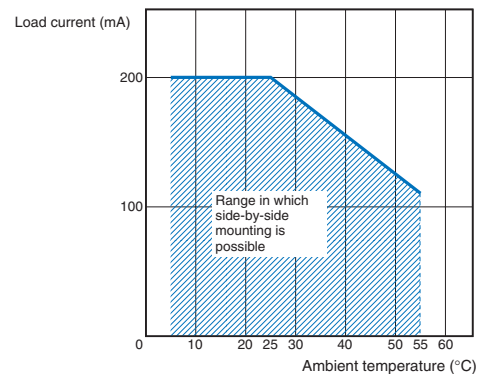

- Always lay the S3D2 input lines, output lines, and the power line separately. Otherwise, malfunction due to noise may occur.

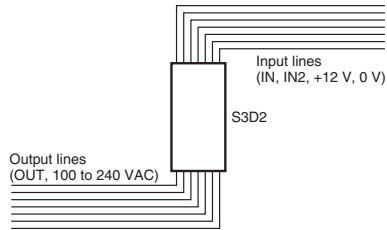

- The power line, through which a large current flows (e.g., to drive a motor) should be wired at least 200 mm away from the S3D2.

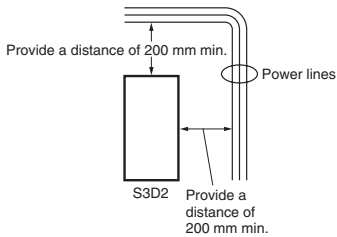

● Removing the Terminal Block Cover

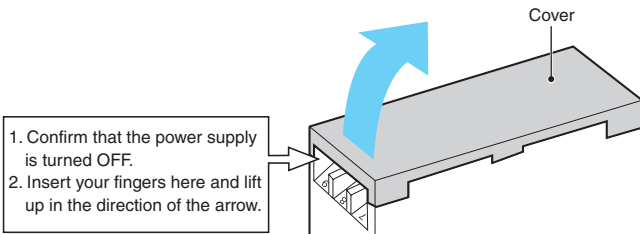

Dimensions

(Unit: mm)

S3D2

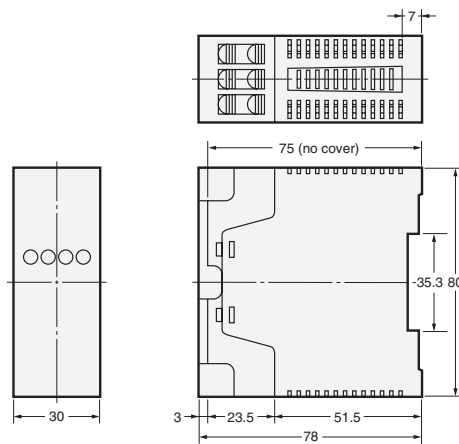
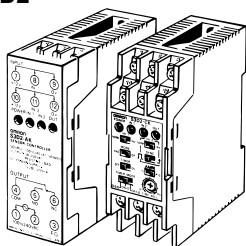

* Terminal block screws: M3.5

Mounting Holes (direct mounting)

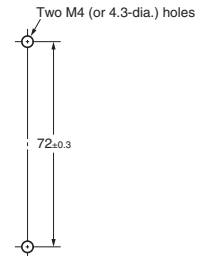

(DIN Track mounting is also possible.)

Read and Understand This Catalog

Please read and understand this catalog before purchasing the products. Please consult your OMRON representative if you have any questions or comments.

Warranty and Limitations of Liability

WARRANTY

OMRON's exclusive warranty is that the products are free from defects in materials and workmanship for a period of one year (or other period if specified) from date of sale by OMRON.

OMRON MAKES NO WARRANTY OR REPRESENTATION, EXPRESS OR IMPLIED, REGARDING NON-INFRINGEMENT, MERCHANTABILITY, OR FITNESS FOR PARTICULAR PURPOSE OF THE PRODUCTS. ANY BUYER OR USER ACKNOWLEDGES THAT THE BUYER OR USER ALONE HAS DETERMINED THAT THE PRODUCTS WILL SUITABLY MEET THE REQUIREMENTS OF THEIR INTENDED USE. OMRON DISCLAIMS ALL OTHER WARRANTIES, EXPRESS OR IMPLIED.

LIMITATIONS OF LIABILITY

OMRON SHALL NOT BE RESPONSIBLE FOR SPECIAL, INDIRECT, OR CONSEQUENTIAL DAMAGES, LOSS OF PROFITS OR COMMERCIAL LOSS IN ANY WAY CONNECTED WITH THE PRODUCTS, WHETHER SUCH CLAIM IS BASED ON CONTRACT, WARRANTY, NEGLIGENCE, OR STRICT LIABILITY.

In no event shall the responsibility of OMRON for any act exceed the individual price of the product on which liability is asserted.

IN NO EVENT SHALL OMRON BE RESPONSIBLE FOR WARRANTY, REPAIR, OR OTHER CLAIMS REGARDING THE PRODUCTS UNLESS OMRON'S ANALYSIS CONFIRMS THAT THE PRODUCTS WERE PROPERLY HANDLED, STORED, INSTALLED, AND MAINTAINED AND NOT SUBJECT TO CONTAMINATION, ABUSE, MISUSE, OR INAPPROPRIATE MODIFICATION OR REPAIR.

Application Considerations

SUITABILITY FOR USE

OMRON shall not be responsible for conformity with any standards, codes, or regulations that apply to the combination of products in the customer's application or use of the products.

At the customer's request, OMRON will provide applicable third party certification documents identifying ratings and limitations of use that apply to the products. This information by itself is not sufficient for a complete determination of the suitability of the products in combination with the end product, machine, system, or other application or use.

The following are some examples of applications for which particular attention must be given. This is not intended to be an exhaustive list of all possible uses of the products, nor is it intended to imply that the uses listed may be suitable for the products:

- Outdoor use, uses involving potential chemical contamination or electrical interference, or conditions or uses not described in this catalog.
- Nuclear energy control systems, combustion systems, railroad systems, aviation systems, medical equipment, amusement machines, vehicles, safety equipment, and installations subject to separate industry or government regulations.
- Systems, machines, and equipment that could present a risk to life or property.

Please know and observe all prohibitions of use applicable to the products.

NEVER USE THE PRODUCTS FOR AN APPLICATION INVOLVING SERIOUS RISK TO LIFE OR PROPERTY WITHOUT ENSURING THAT THE SYSTEM AS A WHOLE HAS BEEN DESIGNED TO ADDRESS THE RISKS, AND THAT THE OMRON PRODUCTS ARE PROPERLY RATED AND INSTALLED FOR THE INTENDED USE WITHIN THE OVERALL EQUIPMENT OR SYSTEM.

PROGRAMMABLE PRODUCTS

OMRON shall not be responsible for the user's programming of a programmable product, or any consequence thereof.

Disclaimers

CHANGE IN SPECIFICATIONS

Product specifications and accessories may be changed at any time based on improvements and other reasons.

It is our practice to change model numbers when published ratings or features are changed, or when significant construction changes are made. However, some specifications of the products may be changed without any notice. When in doubt, special model numbers may be assigned to fix or establish key specifications for your application on your request. Please consult with your OMRON representative at any time to confirm actual specifications of purchased products.

DIMENSIONS AND WEIGHTS

Dimensions and weights are nominal and are not to be used for manufacturing purposes, even when tolerances are shown.

PERFORMANCE DATA

Performance data given in this catalog is provided as a guide for the user in determining suitability and does not constitute a warranty. It may represent the result of OMRON's test conditions, and the users must correlate it to actual application requirements. Actual performance is subject to the OMRON Warranty and Limitations of Liability.

ERRORS AND OMISSIONS

The information in this document has been carefully checked and is believed to be accurate; however, no responsibility is assumed for clerical, typographical, or proofreading errors, or omissions.

2012.8

In the interest of product improvement, specifications are subject to change without notice.

OMRON Corporation
Industrial Automation Company

<http://www.ia.omron.com/>

(c)Copyright OMRON Corporation 2012 All Right Reserved.

Mouser Electronics

Authorized Distributor

Click to View Pricing, Inventory, Delivery & Lifecycle Information:

Omron:

[S3D2-AKD](#) [S3D2-BK-US](#) [S3D2-CC](#) [S3D2-CCD](#) [S3D2-CC-US](#) [S3D2-CKD](#) [S3D2-CK-US](#) [S3D2-DK](#) [S3D2-EK](#)
[S3D2-AK](#) [S3D2-AK-US](#)

Компания «Океан Электроники» предлагает заключение долгосрочных отношений при поставках импортных электронных компонентов на взаимовыгодных условиях!

Наши преимущества:

- Поставка оригинальных импортных электронных компонентов напрямую с производств Америки, Европы и Азии, а так же с крупнейших складов мира;
- Широкая линейка поставок активных и пассивных импортных электронных компонентов (более 30 млн. наименований);
- Поставка сложных, дефицитных, либо снятых с производства позиций;
- Оперативные сроки поставки под заказ (от 5 рабочих дней);
- Экспресс доставка в любую точку России;
- Помощь Конструкторского Отдела и консультации квалифицированных инженеров;
- Техническая поддержка проекта, помощь в подборе аналогов, поставка прототипов;
- Поставка электронных компонентов под контролем ВП;
- Система менеджмента качества сертифицирована по Международному стандарту ISO 9001;
- При необходимости вся продукция военного и аэрокосмического назначения проходит испытания и сертификацию в лаборатории (по согласованию с заказчиком);
- Поставка специализированных компонентов военного и аэрокосмического уровня качества (Xilinx, Altera, Analog Devices, Intersil, Interpoint, Microsemi, Actel, Aeroflex, Peregrine, VPT, Syfer, Eurofarad, Texas Instruments, MS Kennedy, Miteq, Cobham, E2V, MA-COM, Hittite, Mini-Circuits, General Dynamics и др.);

Компания «Океан Электроники» является официальным дистрибьютором и эксклюзивным представителем в России одного из крупнейших производителей разъемов военного и аэрокосмического назначения «**JONHON**», а так же официальным дистрибьютором и эксклюзивным представителем в России производителя высокотехнологичных и надежных решений для передачи СВЧ сигналов «**FORSTAR**».



JONHON

«**JONHON**» (основан в 1970 г.)

Разъемы специального, военного и аэрокосмического назначения:

(Применяются в военной, авиационной, аэрокосмической, морской, железнодорожной, горно- и нефтедобывающей отраслях промышленности)

«**FORSTAR**» (основан в 1998 г.)

ВЧ соединители, коаксиальные кабели, кабельные сборки и микроволновые компоненты:

(Применяются в телекоммуникациях гражданского и специального назначения, в средствах связи, РЛС, а так же военной, авиационной и аэрокосмической отраслях промышленности).



Телефон: 8 (812) 309-75-97 (многоканальный)

Факс: 8 (812) 320-03-32

Электронная почта: ocean@oceanchips.ru

Web: <http://oceanchips.ru/>

Адрес: 198099, г. Санкт-Петербург, ул. Калинина, д. 2, корп. 4, лит. А