

### FEATURES

- Maximum output current: 300 mA**
- Input voltage range: 2.5 V to 5.5 V**
- Light load efficient**  
 $I_{\text{GND}} = 75 \mu\text{A}$  with 100  $\mu\text{A}$  load
- Low shutdown current: <1  $\mu\text{A}$**
- Very low dropout voltage: 170 mV @ 300 mA load**
- Initial accuracy:  $\pm 1\%$**
- Accuracy over line, load, and temperature:  $\pm 2\%$**
- 16 fixed output voltage options with soft start:  
0.75 V to 3.3 V (ADP1712)**
- Adjustable output voltage option: 0.8 V to 5.0 V  
(ADP1712 Adjustable)**
- 16 fixed output voltage options with reference bypass:  
0.75 V to 3.3 V (ADP1713)**
- 16 fixed output voltage options with tracking:  
0.75 V to 3.3 V (ADP1714)**
- Low output noise: 40  $\mu\text{V}$  rms**
- High PSRR: 72 dB @ 1 kHz**
- Stable with small 2.2  $\mu\text{F}$  ceramic output capacitor**
- Excellent load/line transient response**
- Current limit and thermal overload protection**
- Logic controlled enable**
- 5-lead TSOT package**

### APPLICATIONS

- Mobile phones**
- Digital camera and audio devices**
- Portable and battery-powered equipment**
- Post dc-dc regulation**

### GENERAL DESCRIPTION

The ADP1712/ADP1713/ADP1714, available in a tiny, 5-lead TSOT package, are low dropout linear regulators that operate from 2.5 V to 5.5 V and provide up to 300 mA of output current. The low 170 mV dropout voltage at a 300 mA load improves efficiency and allows operation over a wide input voltage range. Using a novel scaling architecture, ground current is a very low 75  $\mu\text{A}$  when driving a 100  $\mu\text{A}$  load, making the ADP1712/ADP1713/ADP1714 ideal for battery-operated portable equipment.

The ADP1712/ADP1713/ADP1714 are available in 16 fixed output voltage options. The ADP1712 is also available in an adjustable version, which allows output voltages that range from 0.8 V to 5 V via an external divider. The ADP1712 fixed version allows an external capacitor to be connected to program the

### TYPICAL APPLICATION CIRCUITS

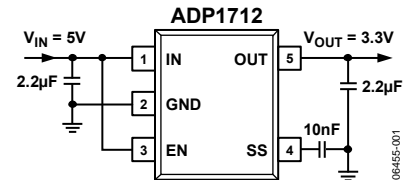

Figure 1. ADP1712 with Fixed Output Voltage and Soft-Start Capacitor, 3.3 V

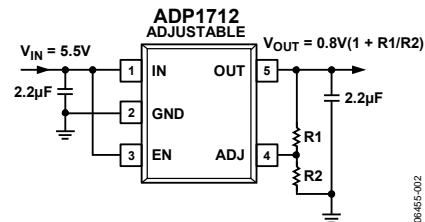

Figure 2. ADP1712 with Adjustable Output Voltage, 0.8 V to 5.0 V

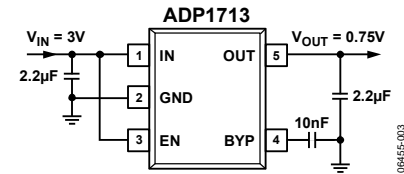

Figure 3. ADP1713 with Fixed Output Voltage and Bypass Capacitor, 0.75 V

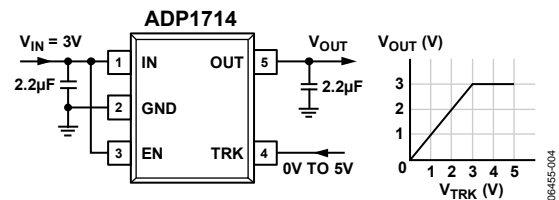

Figure 4. ADP1714 with Output Voltage Tracking

soft-start time. The ADP1713 allows a reference bypass capacitor to be connected, which reduces output voltage noise and improves power supply rejection. The ADP1714 includes a tracking feature, which allows the output to follow an external voltage rail or reference.

The ADP1712/ADP1713/ADP1714 are optimized for stable operation with small 2.2  $\mu\text{F}$  ceramic output capacitors, allowing good transient performance while occupying minimal board space. An enable pin controls the output voltage on all devices, and an undervoltage lockout circuit disables the regulator if  $I_{\text{IN}}$  drops below a minimum threshold. The parts also have short circuit protection and thermal overload protection, which prevent damage to the devices in adverse conditions.

#### Rev. A

Information furnished by Analog Devices is believed to be accurate and reliable. However, no responsibility is assumed by Analog Devices for its use, nor for any infringements of patents or other rights of third parties that may result from its use. Specifications subject to change without notice. No license is granted by implication or otherwise under any patent or patent rights of Analog Devices. Trademarks and registered trademarks are the property of their respective owners.

## TABLE OF CONTENTS

|  |    |  |    |
|--|----|--|----|
| Features .....                                     | 1  | Adjustable Output Voltage (ADP1712 Adjustable) ..... | 11 |
| Applications.....                                  | 1  | Bypass Capacitor (ADP1713) .....                     | 11 |
| Typical Application Circuits.....                  | 1  | Track Mode (ADP1714) .....                           | 11 |
| General Description .....                          | 1  | Enable Feature .....                                 | 11 |
| Revision History .....                             | 2  | Undervoltage Lockout (UVLO) .....                    | 11 |
| Specifications.....                                | 3  | Application Information.....                         | 12 |
| Absolute Maximum Ratings.....                      | 5  | Capacitor Selection .....                            | 12 |
| Thermal Resistance .....                           | 5  | Current Limit and Thermal Overload Protection .....  | 12 |
| ESD Caution.....                                   | 5  | Thermal Considerations.....                          | 13 |
| Pin Configurations and Function Descriptions ..... | 6  | Printed Circuit Board Layout Considerations .....    | 14 |
| Typical Performance Characteristics .....          | 7  | Outline Dimensions .....                             | 15 |
| Theory of Operation .....                          | 10 | Ordering Guide .....                                 | 15 |
| Soft-Start Function (ADP1712).....                 | 10 |  |    |

## REVISION HISTORY

### 6/09—Rev. 0 to Rev. A

|                                  |    |
|----------------------------------|----|
| Updated Outline Dimensions ..... | 15 |
| Changes to Ordering Guide .....  | 15 |

### 1/07—Revision 0: Initial Version

## SPECIFICATIONS

$V_{IN} = (V_{OUT} + 0.5 \text{ V})$  or 2.5 V (whichever is greater),  $I_{OUT} = 10 \text{ mA}$ ,  $C_{IN} = C_{OUT} = 2.2 \text{ }\mu\text{F}$ ,  $T_A = 25^\circ\text{C}$ , unless otherwise noted.

Table 1.

| Parameter  | Symbol                          | Conditions   | Min            | Typ                    | Max  | Unit   |
|--|---------------------------------|--|----------------|------------------------|--|--|
| INPUT VOLTAGE RANGE  | $V_{IN}$                        | $T_J = -40^\circ\text{C}$ to $+125^\circ\text{C}$  | 2.5            |                        | 5.5  | V  |
| OPERATING SUPPLY CURRENT   | $I_{GND}$                       | $I_{OUT} = 0 \text{ }\mu\text{A}$<br>$I_{OUT} = 0 \text{ }\mu\text{A}$ , $T_J = -40^\circ\text{C}$ to $+125^\circ\text{C}$<br>$I_{OUT} = 100 \text{ }\mu\text{A}$<br>$I_{OUT} = 100 \text{ }\mu\text{A}$ , $T_J = -40^\circ\text{C}$ to $+125^\circ\text{C}$<br>$I_{OUT} = 100 \text{ mA}$<br>$I_{OUT} = 100 \text{ mA}$ , $T_J = -40^\circ\text{C}$ to $+125^\circ\text{C}$<br>$I_{OUT} = 300 \text{ mA}$<br>$I_{OUT} = 300 \text{ mA}$ , $T_J = -40^\circ\text{C}$ to $+125^\circ\text{C}$   |                | 60<br>75<br>210<br>365 | 70<br>85<br>250<br>420                           | $\mu\text{A}$<br>$\mu\text{A}$<br>$\mu\text{A}$<br>$\mu\text{A}$<br>$\mu\text{A}$<br>$\mu\text{A}$ |
| SHUTDOWN CURRENT   | $I_{GND-SD}$                    | EN = GND<br>EN = GND, $T_J = -40^\circ\text{C}$ to $+125^\circ\text{C}$  |                | 0.1                    | 1.0  | $\mu\text{A}$<br>$\mu\text{A}$   |
| FIXED OUTPUT VOLTAGE ACCURACY (ADP1712 FIXED, ADP1713, AND ADP1714)                                    | $V_{OUT}$                       | $I_{OUT} = 10 \text{ mA}$<br>$100 \text{ }\mu\text{A} < I_{OUT} < 300 \text{ mA}$ , $T_J = -40^\circ\text{C}$ to $+125^\circ\text{C}$  | -1<br>-2       |                        | +1<br>+2   | %<br>%   |
| ADJUSTABLE OUTPUT VOLTAGE ACCURACY (ADP1712 ADJUSTABLE) <sup>1</sup>                                   | $V_{OUT}$                       | $I_{OUT} = 10 \text{ mA}$<br>$100 \text{ }\mu\text{A} < I_{OUT} < 300 \text{ mA}$ , $T_J = -40^\circ\text{C}$ to $+125^\circ\text{C}$  | 0.792<br>0.784 | 0.8<br>0.8             | 0.808<br>0.816                                   | V<br>V   |
| LINE REGULATION  | $\Delta V_{OUT}/\Delta V_{IN}$  | $V_{IN} = (V_{OUT} + 0.5 \text{ V})$ to 5.5 V, $T_J = -40^\circ\text{C}$ to $+125^\circ\text{C}$   | -0.25          |                        | +0.25  | %/V  |
| LOAD REGULATION <sup>2</sup>   | $\Delta V_{OUT}/\Delta I_{OUT}$ | $I_{OUT} = 10 \text{ mA}$ to 300 mA<br>$I_{OUT} = 10 \text{ mA}$ to 300 mA, $T_J = -40^\circ\text{C}$ to $+125^\circ\text{C}$  |                | 0.001                  | 0.004  | %/mA<br>%/mA   |
| DROPOUT VOLTAGE <sup>3</sup>   | $V_{DROPOUT}$                   | $I_{OUT} = 100 \text{ mA}$ , $V_{OUT} \geq 3.0 \text{ V}$<br>$I_{OUT} = 100 \text{ mA}$ , $V_{OUT} \geq 3.0 \text{ V}$ , $T_J = -40^\circ\text{C}$ to $+125^\circ\text{C}$<br>$I_{OUT} = 300 \text{ mA}$ , $V_{OUT} \geq 3.0 \text{ V}$<br>$I_{OUT} = 300 \text{ mA}$ , $V_{OUT} \geq 3.0 \text{ V}$ , $T_J = -40^\circ\text{C}$ to $+125^\circ\text{C}$<br>$I_{OUT} = 100 \text{ mA}$ , $2.5 \text{ V} \leq V_{OUT} < 3.0 \text{ V}$<br>$I_{OUT} = 100 \text{ mA}$ , $2.5 \text{ V} \leq V_{OUT} < 3.0 \text{ V}$ , $T_J = -40^\circ\text{C}$ to $+125^\circ\text{C}$<br>$I_{OUT} = 300 \text{ mA}$ , $2.5 \text{ V} \leq V_{OUT} < 3.0 \text{ V}$<br>$I_{OUT} = 300 \text{ mA}$ , $2.5 \text{ V} \leq V_{OUT} < 3.0 \text{ V}$ , $T_J = -40^\circ\text{C}$ to $+125^\circ\text{C}$ |                | 60<br>170<br>70<br>200 | 70<br>80<br>205<br>230<br>85<br>95<br>235<br>270 | mV<br>mV<br>mV<br>mV<br>mV<br>mV<br>mV<br>mV   |
| START-UP TIME <sup>4</sup><br>ADP1712 Adjustable and ADP1714<br>ADP1712 External Soft Start<br>ADP1713 | $T_{START-UP}$                  | $C_{SS} = 10 \text{ nF}$<br>With 10 nF bypass capacitor  |                | 70<br>7.3<br>90        |  | $\mu\text{s}$<br>ms<br>$\mu\text{s}$   |
| CURRENT LIMIT THRESHOLD <sup>5</sup>   | $I_{LIMIT}$                     |  | 380            | 500                    | 700  | mA   |
| THERMAL SHUTDOWN THRESHOLD   | $T_{SD}$                        | $T_J$ rising   |                | 150                    |  | $^\circ\text{C}$   |
| THERMAL SHUTDOWN HYSTERESIS  | $T_{SD-HYS}$                    |  |                | 15                     |  | $^\circ\text{C}$   |
| SOFT-START SOURCE CURRENT (ADP1712 WITH EXTERNAL SOFT START)   | $SS_{I-SOURCE}$                 | SS = GND   | 0.8            | 1.2                    | 1.5  | $\mu\text{A}$  |
| UVLO ACTIVE THRESHOLD  | $UVLO_{ACTIVE}$                 | $V_{IN}$ falling   | 2              |                        |  | V  |
| UVLO INACTIVE THRESHOLD  | $UVLO_{INACTIVE}$               | $V_{IN}$ rising  |                |                        | 2.45   | V  |
| UVLO HYSTERESIS  | $UVLO_{HYS}$                    |  |                | 250                    |  | mV   |
| $V_{OUT}$ to $V_{TRK}$ ACCURACY (ADP1714)  | $V_{TRK-ERROR}$                 | $0 \text{ V} \leq V_{TRK} \leq (0.5 \times V_{OUT(NOM)})$ , $V_{OUT(NOM)} \leq 1.8 \text{ V}$ ,<br>$T_J = -40^\circ\text{C}$ to $+125^\circ\text{C}$<br>$0 \text{ V} \leq V_{TRK} \leq (0.5 \times V_{OUT(NOM)})$ , $V_{OUT(NOM)} > 1.8 \text{ V}$ ,<br>$T_J = -40^\circ\text{C}$ to $+125^\circ\text{C}$  | -40<br>-80     |                        | +40<br>+80                                       | mV<br>mV   |

# ADP1712/ADP1713/ADP1714

| Parameter                                      | Symbol                | Conditions   | Min | Typ | Max | Unit              |
|--|-----------------------|--|-----|-----|-----|-------------------|
| EN INPUT LOGIC HIGH                            | $V_{IH}$              | $2.5\text{ V} \leq V_{IN} \leq 5.5\text{ V}$   | 1.8 |     |     | V                 |
| EN INPUT LOGIC LOW                             | $V_{IL}$              | $2.5\text{ V} \leq V_{IN} \leq 5.5\text{ V}$   |     |     | 0.4 | V                 |
| EN INPUT LEAKAGE CURRENT                       | $V_{I-LEAKAGE}$       | EN = IN or GND   |     | 0.1 | 1   | $\mu\text{A}$     |
| ADJ INPUT BIAS CURRENT<br>(ADP1712 ADJUSTABLE) | ADJ <sub>I-BIAS</sub> |  |     | 30  | 100 | nA                |
| OUTPUT NOISE<br>ADP1713                        | OUT <sub>NOISE</sub>  | 10 Hz to 100 kHz, $V_{IN} = 5.0\text{ V}$ , $V_{OUT} = 0.75\text{ V}$ ,<br>with 10 nF bypass capacitor |     | 40  |     | $\mu\text{V rms}$ |
| ADP1712 and ADP1714                            |                       | 10 Hz to 100 kHz, $V_{IN} = 5.0\text{ V}$ , $V_{OUT} = 3.3\text{ V}$                                   |     | 380 |     | $\mu\text{V rms}$ |
| POWER SUPPLY REJECTION RATIO<br>ADP1713        | PSRR                  | 1 kHz, $V_{IN} = 5.0\text{ V}$ , $V_{OUT} = 0.75\text{ V}$ , with 10 nF<br>bypass capacitor            |     | 72  |     | dB                |
| ADP1712 and ADP1714                            |                       | 1 kHz, $V_{IN} = 5.0\text{ V}$ , $V_{OUT} = 3.3\text{ V}$  |     | 65  |     | dB                |

<sup>1</sup> Accuracy when OUT is connected directly to ADJ. When OUT voltage is set by external feedback resistors, absolute accuracy in adjust mode depends on the tolerances of resistors used.

<sup>2</sup> Based on an end-point calculation using 10 mA and 300 mA loads. See Figure 10 for typical load regulation performance for loads less than 10 mA.

<sup>3</sup> Dropout voltage is defined as the input-to-output voltage differential when the input voltage is set to the nominal output voltage. This applies only for output voltages above 2.5 V.

<sup>4</sup> Start-up time is defined as the time between the rising edge of EN to OUT being at 95% of its nominal value.

<sup>5</sup> Current limit threshold is defined as the current at which the output voltage drops to 90% of the specified typical value. For example, the current limit for a 1.0 V output voltage is defined as the current that causes the output voltage to drop to 90% of 1.0 V, or 0.9 V.

## ABSOLUTE MAXIMUM RATINGS

Table 2.

| Parameter                            | Rating          |
|--------------------------------------|-----------------|
| IN to GND                            | -0.3 V to +6 V  |
| OUT to GND                           | -0.3 V to IN    |
| EN to GND                            | -0.3 V to +6 V  |
| SS/ADJ/BYP/TRK to GND                | -0.3 V to +6 V  |
| Storage Temperature Range            | -65°C to +150°C |
| Operating Junction Temperature Range | -40°C to +125°C |
| Lead Temperature, Soldering (10 sec) | 300°C           |
| Soldering Conditions                 | JEDEC J-STD-020 |

Stresses above those listed under Absolute Maximum Ratings may cause permanent damage to the device. This is a stress rating only; functional operation of the device at these or any other conditions above those indicated in the operational section of this specification is not implied. Exposure to absolute maximum rating conditions for extended periods may affect device reliability.

## THERMAL RESISTANCE

$\theta_{JA}$  is specified for the worst-case conditions, that is, a device soldered in a circuit board for surface-mount packages.

Table 3. Thermal Resistance

| Package Type | $\theta_{JA}$ | Unit |
|--------------|---------------|------|
| 5-Lead TSOT  | 170           | °C/W |

## ESD CAUTION



**ESD (electrostatic discharge) sensitive device.** Charged devices and circuit boards can discharge without detection. Although this product features patented or proprietary protection circuitry, damage may occur on devices subjected to high energy ESD. Therefore, proper ESD precautions should be taken to avoid performance degradation or loss of functionality.

# ADP1712/ADP1713/ADP1714

## PIN CONFIGURATIONS AND FUNCTION DESCRIPTIONS

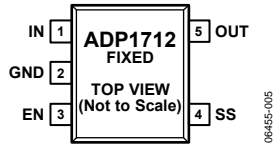

Figure 5. 5-Lead TSOT (UJ-Suffix)

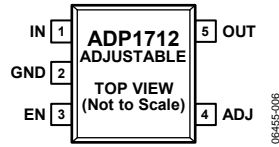

Figure 6. 5-Lead TSOT (UJ-Suffix)

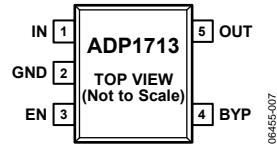

Figure 7. 5-Lead TSOT (UJ-Suffix)

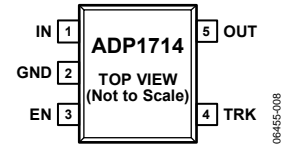

Figure 8. 5-Lead TSOT (UJ-Suffix)

Table 4. Pin Function Descriptions

| ADP1712 Fixed Pin No. | ADP1712 Adjustable Pin No. | ADP1713 Pin No. | ADP1714 Pin No. | Mnemonic | Description  |
|-----------------------|----------------------------|-----------------|-----------------|----------|--|
| 1                     | 1                          | 1               | 1               | IN       | Regulator Input Supply. Bypass IN to GND with a 2.2 $\mu$ F or greater capacitor.  |
| 2                     | 2                          | 2               | 2               | GND      | Ground.  |
| 3                     | 3                          | 3               | 3               | EN       | Enable Input. Drive EN high to turn on the regulator; drive it low to turn off the regulator. For automatic startup, connect EN to IN.                 |
| 4                     |                            |                 |                 | SS       | Soft Start. Connect a capacitor between SS and GND to set the output start-up time.  |
|                       | 4                          | 4               |                 | ADJ      | Adjust. A resistor divider from OUT to ADJ sets the output voltage.  |
|                       |                            |                 |                 | BYP      | Bypass. Connect a 1 nF or greater capacitor (10 nF recommended) between BYP and GND to reduce the internal reference noise for low noise applications. |
|                       |                            |                 | 4               | TRK      | Track. The output follows the voltage placed on the TRK pin. (See the Theory of Operation section for a more detailed description.)                    |
| 5                     | 5                          | 5               | 5               | OUT      | Regulated Output Voltage. Bypass OUT to GND with a 2.2 $\mu$ F or greater capacitor.   |

TYPICAL PERFORMANCE CHARACTERISTICS

$V_{IN} = 3.8\text{ V}$ ,  $I_{OUT} = 10\text{ mA}$ ,  $C_{IN} = C_{OUT} = 2.2\text{ }\mu\text{F}$ ,  $T_A = 25^\circ\text{C}$ , unless otherwise noted.

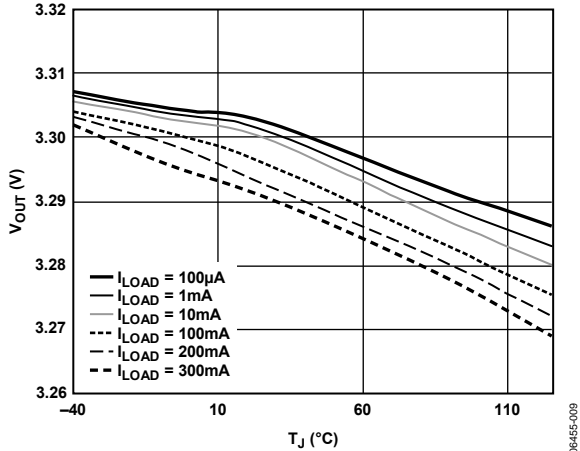

Figure 9. Output Voltage vs. Junction Temperature

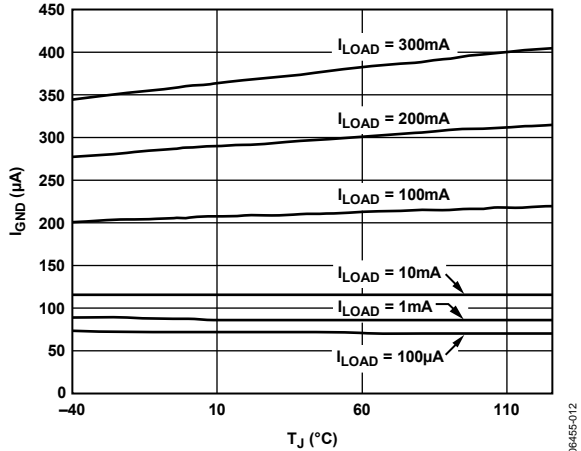

Figure 12. Ground Current vs. Junction Temperature

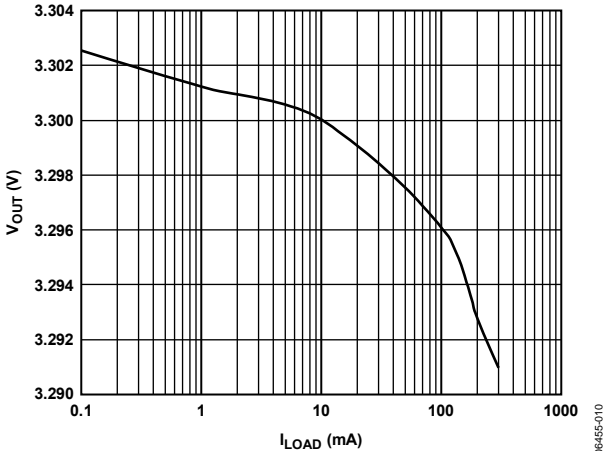

Figure 10. Output Voltage vs. Load Current

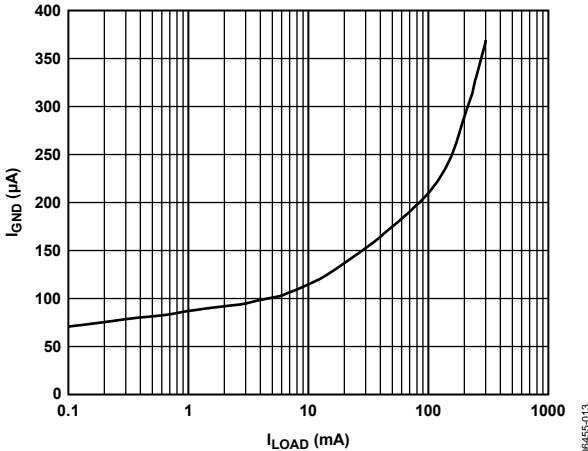

Figure 13. Ground Current vs. Load Current

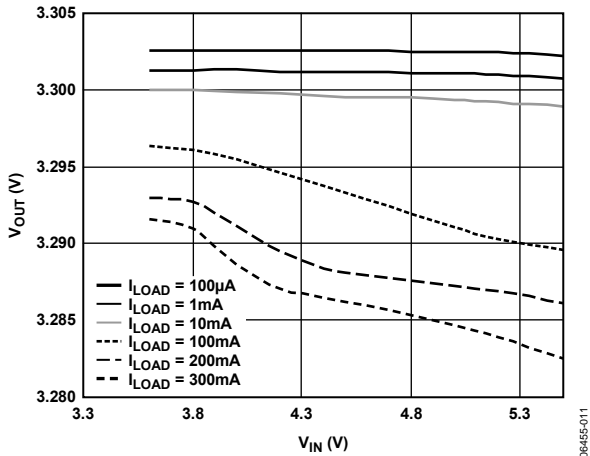

Figure 11. Output Voltage vs. Input Voltage

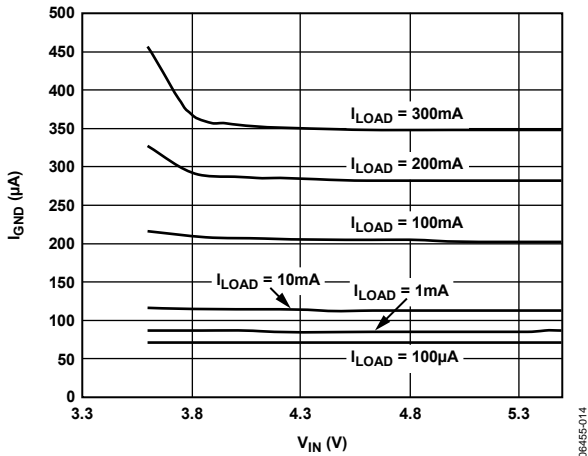

Figure 14. Ground Current vs. Input Voltage

# ADP1712/ADP1713/ADP1714

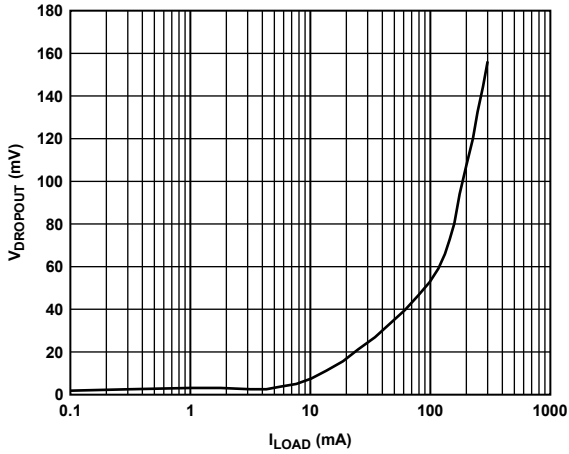

Figure 15. Dropout Voltage vs. Load Current

06455-015

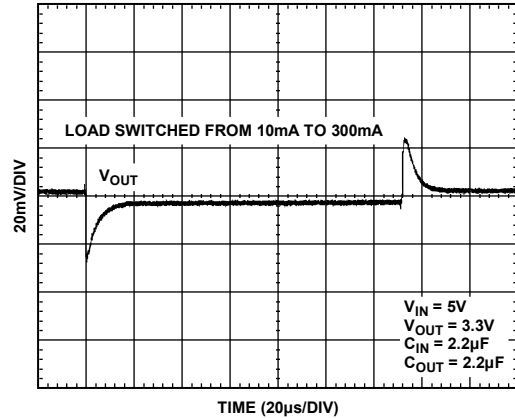

Figure 18. Load Transient Response

06455-018

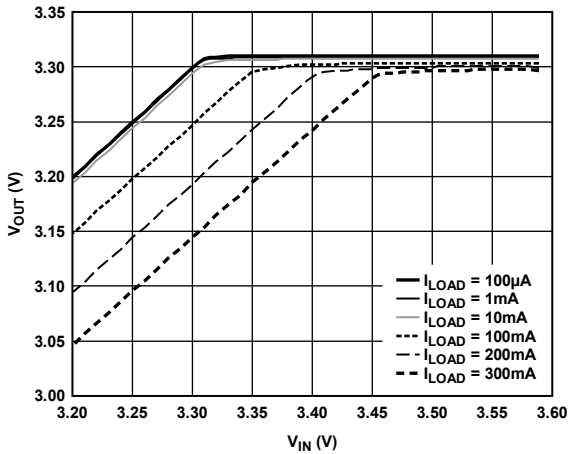

Figure 16. Output Voltage vs. Input Voltage (in Dropout)

06455-016

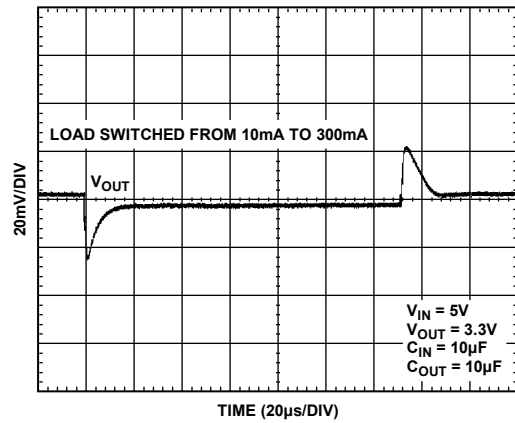

Figure 19. Load Transient Response

06455-019

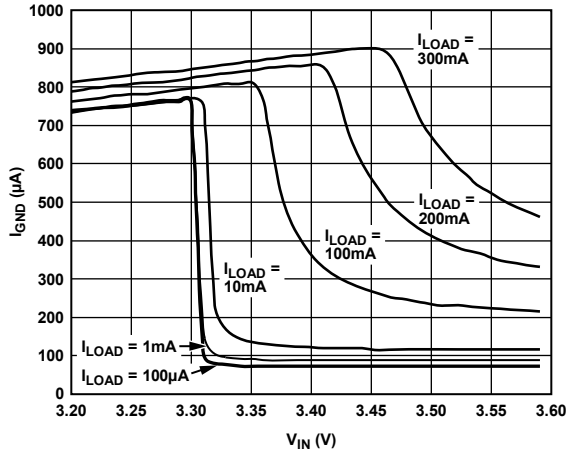

Figure 17. Ground Current vs. Input Voltage (in Dropout)

06455-017

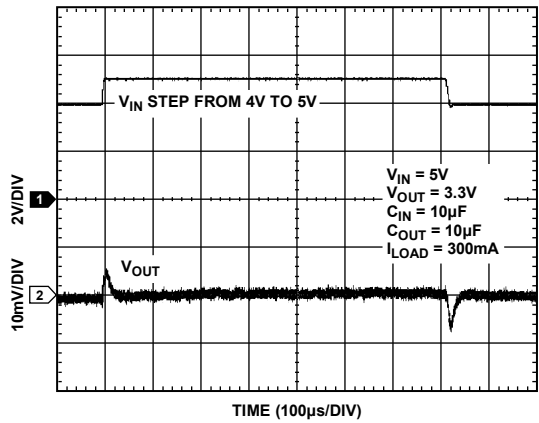

Figure 20. Line Transient Response

06455-020



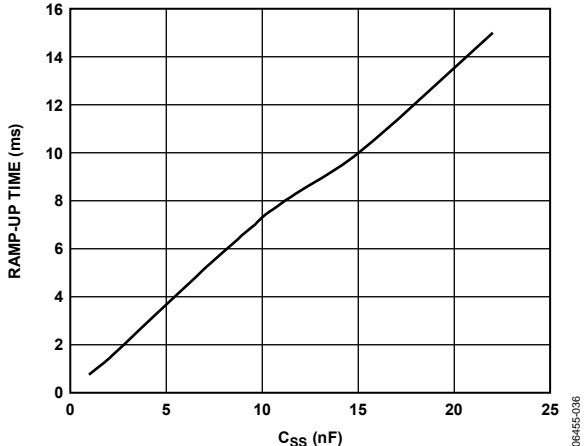

Figure 21. Output Voltage Ramp-Up Time vs. Soft-Start Capacitor Value

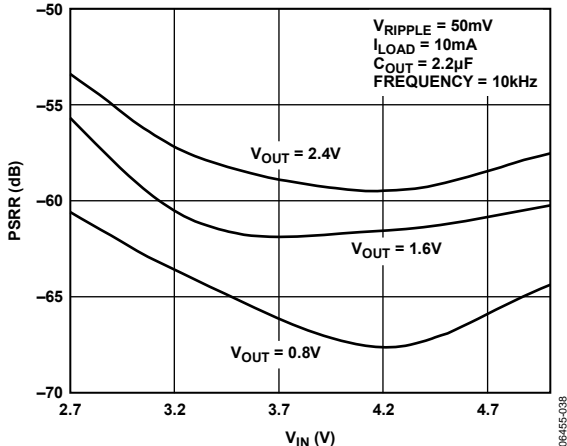

Figure 23. ADP1712 Adjustable Power Supply Rejection Ratio vs. Input Voltage

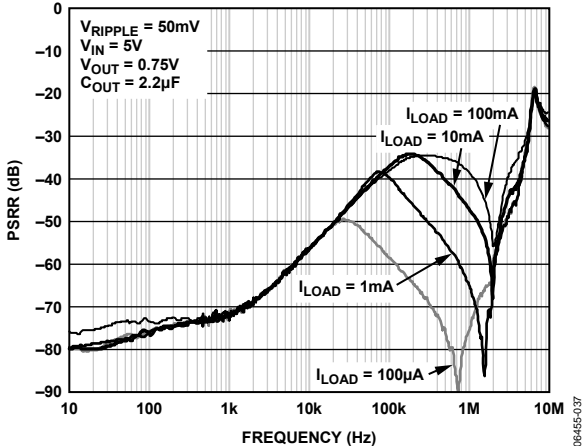

Figure 22. ADP1713 Power Supply Rejection Ratio vs. Frequency (10 nF Bypass Capacitor)

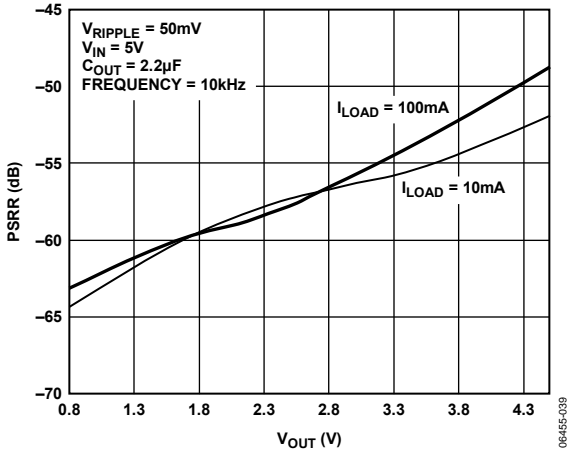

Figure 24. ADP1712 Adjustable Power Supply Rejection Ratio vs. Output Voltage

# ADP1712/ADP1713/ADP1714

## THEORY OF OPERATION

The ADP1712/ADP1713/ADP1714 are low dropout linear regulators that use an advanced, proprietary architecture to provide high power supply rejection ratio (PSRR) and excellent line and load transient response with just a small 2.2  $\mu\text{F}$  ceramic output capacitor. All devices operate from a 2.5 V to 5.5 V input rail and provide up to 300 mA of output current. Incorporating a novel scaling architecture, ground current is very low when driving light loads. Ground current in the shutdown mode is typically less than 1  $\mu\text{A}$ .

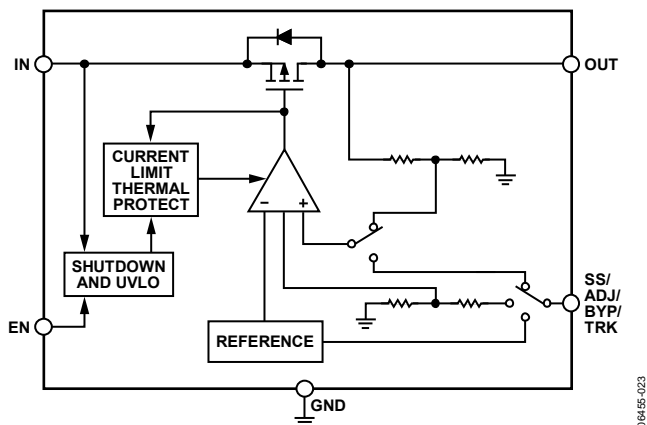

Figure 25. Internal Block Diagram

Internally, the ADP1712/ADP1713/ADP1714 each consist of a reference, an error amplifier, a feedback voltage divider, and a PMOS pass transistor. Output current is delivered via the PMOS pass device, which is controlled by the error amplifier. The error amplifier compares the reference voltage with the feedback voltage from the output and amplifies the difference. If the feedback voltage is lower than the reference voltage, the gate of the PMOS device is pulled lower, which allows more current to pass and increases the output voltage. If the feedback voltage is higher than the reference voltage, the gate of the PMOS device is pulled higher, allowing less current to pass and decreasing the output voltage.

The ADP1712 is available in two versions, one with a fixed output voltage and one with an adjustable output voltage. The fixed output voltage is set internally to one of sixteen values between 0.75 V and 3.3 V, using an internal feedback network. The adjustable output voltage can be set to between 0.8 V and 5.0 V by an external voltage divider connected from OUT to ADJ. The ADP1713 and ADP1714 are available in fixed output voltage options only. The ADP1712 fixed version allows an external soft-start capacitor to be connected between the SS pin and GND, which controls the output voltage ramp during startup. The ADP1713 allows a reference bypass capacitor to be connected between the BYP pin and GND, which reduces output voltage noise and improves power supply rejection. The ADP1714 features a track pin, which allows the output voltage to follow the voltage at the TRK pin.

A logic on the EN pin determines if the output is active. When EN is high, the output is on, and when EN is low, the output is off.

## SOFT-START FUNCTION (ADP1712)

For applications that require a controlled startup, the ADP1712 provides a programmable soft-start function. Programmable soft start is useful for reducing inrush current upon startup and for providing voltage sequencing. To implement soft start, connect a small ceramic capacitor from SS to GND. Upon startup, a 1.2  $\mu\text{A}$  current source charges this capacitor. The ADP1712 start-up output voltage is limited by the voltage at SS, providing a smooth ramp up to the nominal output voltage. The soft-start time is calculated by

$$T_{SS} = V_{REF} \times (C_{SS}/I_{SS}) \quad (1)$$

where:

$T_{SS}$  is the soft-start period.

$V_{REF}$  is the 0.8 V reference voltage.

$C_{SS}$  is the soft-start capacitance from SS to GND.

$I_{SS}$  is the current sourced from SS (1.2  $\mu\text{A}$ ).

When the ADP1712 is disabled (using EN), the soft-start capacitor is discharged to GND through an internal 100  $\Omega$  resistor.

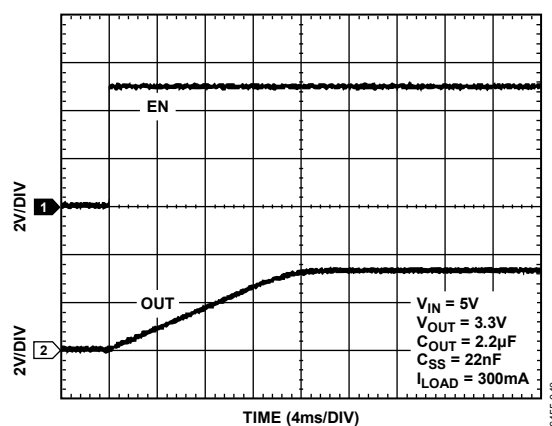

Figure 26. OUT Ramp-Up with External Soft-Start Capacitor

The ADP1712 adjustable version, ADP1713, and ADP1714 have no pins for soft start, so the function is switched to an internal soft-start capacitor. This sets the soft-start ramp-up period to approximately 24  $\mu\text{s}$ .

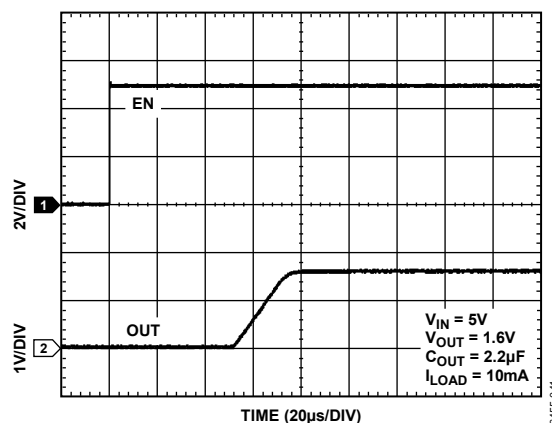

Figure 27. OUT Ramp-Up with Internal Soft-Start

## ADJUSTABLE OUTPUT VOLTAGE (ADP1712 ADJUSTABLE)

The ADP1712 adjustable version can have its output voltage set over a 0.8 V to 5.0 V range. The output voltage is set by connecting a resistive voltage divider from OUT to ADJ. The output voltage is calculated using the equation

$$V_{OUT} = 0.8 \text{ V} (1 + R1/R2) \quad (2)$$

where:

$R1$  is the resistor from OUT to ADJ.  
 $R2$  is the resistor from ADJ to GND.

The maximum bias current into ADJ is 100 nA, so for less than 0.5% error due to the bias current, use values less than 60 k $\Omega$  for  $R2$ .

## BYPASS CAPACITOR (ADP1713)

The ADP1713 allows for an external bypass capacitor to be connected to the internal reference, which reduces output voltage noise and improves power supply rejection. A low leakage capacitor of 1 nF or greater (10 nF is recommended) must be connected between the BYP and GND pins.

## TRACK MODE (ADP1714)

The ADP1714 includes a tracking mode feature. As shown in Figure 28, if the voltage applied at the TRK pin is less than the nominal output voltage, OUT is equal to the voltage at TRK. Otherwise, OUT regulates to its nominal output value.

For example, consider an ADP1714 with a nominal output voltage of 3 V. If the voltage applied to its TRK pin is greater than 3 V, OUT maintains a nominal output voltage of 3 V. If the voltage applied to TRK is reduced below 3 V, OUT tracks this voltage. OUT can track the TRK pin voltage from the nominal value all the way down to 0 V. A voltage divider is present from TRK to the error amplifier input with a divider ratio equal to the divider from OUT to the error amplifier. This sets the output voltage equal to the tracking voltage. Both divider ratios are set by post-package trim, depending on the desired output voltage.

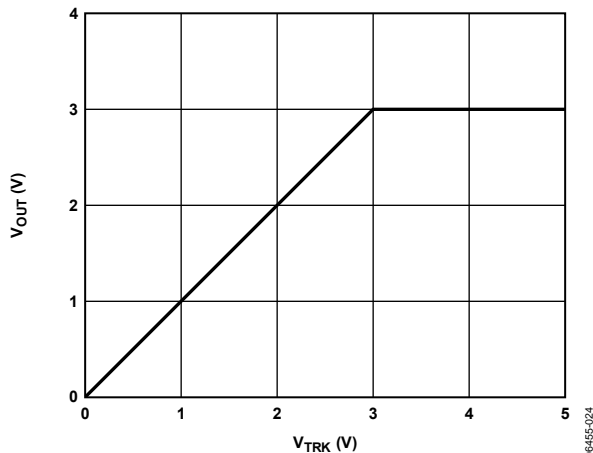

Figure 28. ADP1714 Output Voltage vs. Tracking Voltage with Nominal Output Voltage Set to 3 V

## ENABLE FEATURE

The ADP1712/ADP1713/ADP1714 use the EN pin to enable and disable the OUT pin under normal operating conditions. As shown in Figure 29, when a rising voltage on EN crosses the active threshold, OUT turns on. When a falling voltage on EN crosses the inactive threshold, OUT turns off.

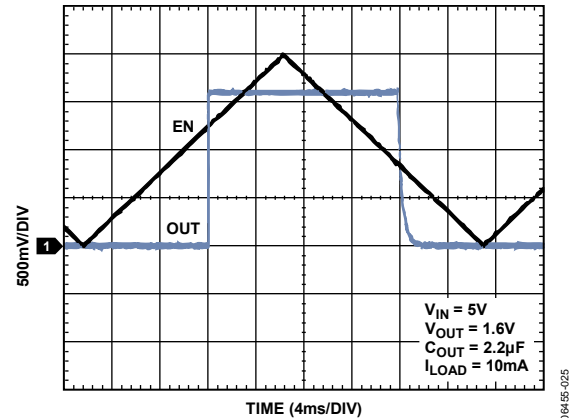

Figure 29. ADP1712 Adjustable Typical EN Pin Operation

As can be seen, the EN pin has hysteresis built in. This prevents on/off oscillations that can occur due to noise on the EN pin as it passes through the threshold points.

The EN pin active/inactive thresholds are derived from the IN voltage. Therefore, these thresholds vary with changing input voltage. Figure 30 shows typical EN active/inactive thresholds when the input voltage varies from 2.5 V to 5.5 V.

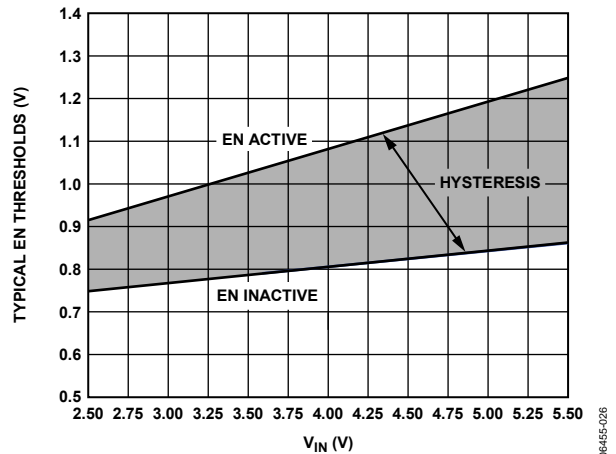

Figure 30. Typical EN Pin Thresholds vs. Input Voltage

## UNDERVOLTAGE LOCKOUT (UVLO)

The ADP1712/ADP1713/ADP1714 have an undervoltage lockout circuit, which monitors the voltage on the IN pin. When the voltage on IN drops below 2 V (minimum), the circuit activates, disabling the OUT pin.

## APPLICATION INFORMATION

### CAPACITOR SELECTION

#### Output Capacitor

The ADP1712/ADP1713/ADP1714 are designed for operation with small, space-saving ceramic capacitors, but they function with most commonly used capacitors as long as care is taken about the effective series resistance (ESR) value. The ESR of the output capacitor affects stability of the LDO control loop. A minimum of 2.2  $\mu\text{F}$  capacitance with an ESR of 500 m $\Omega$  or less is recommended to ensure stability of the ADP1712/ADP1713/ADP1714. Transient response to changes in load current is also affected by output capacitance. Using a larger value of output capacitance improves the transient response of the ADP1712/ADP1713/ADP1714 to large changes in load current. Figure 31 and Figure 32 show the transient responses for output capacitance values of 2.2  $\mu\text{F}$  and 10  $\mu\text{F}$ , respectively.

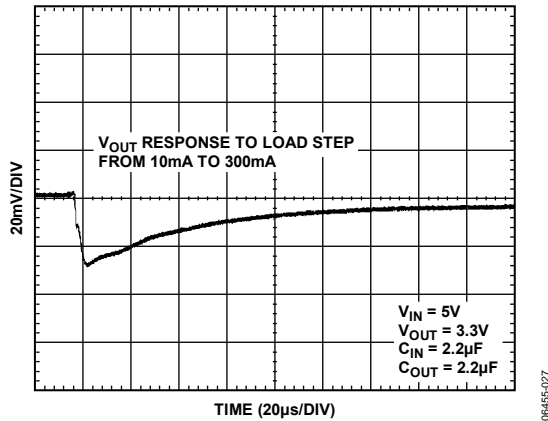

Figure 31. Output Transient Response,  $C_{OUT} = 2.2 \mu\text{F}$

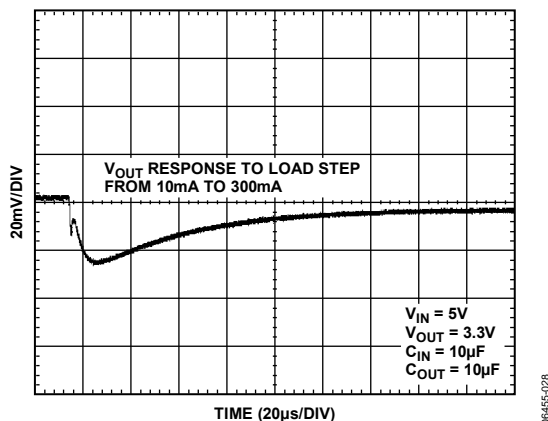

Figure 32. Output Transient Response,  $C_{OUT} = 10 \mu\text{F}$

#### Input Bypass Capacitor

Connecting a 2.2  $\mu\text{F}$  capacitor from the IN pin to GND reduces the circuit sensitivity to printed circuit board (PCB) layout,

especially when long input traces or high source impedance are encountered. If greater than 2.2  $\mu\text{F}$  of output capacitance is required, increasing the input capacitor to match is recommended.

#### Input and Output Capacitor Properties

Any good quality ceramic capacitors can be used with the ADP1712/ADP1713/ADP1714, as long as they meet the minimum capacitance and maximum ESR requirements. Ceramic capacitors are manufactured with a variety of dielectrics, each with different behavior over temperature and applied voltage. Capacitors must have a dielectric adequate to ensure the minimum capacitance over the necessary temperature range and dc bias conditions. X5R or X7R dielectrics with a voltage rating of 6.3 V or 10 V are recommended. Y5V and Z5U dielectrics are not recommended, due to their poor temperature and dc bias characteristics.

### CURRENT LIMIT AND THERMAL OVERLOAD PROTECTION

The ADP1712/ADP1713/ADP1714 are protected against damage due to excessive power dissipation by current and thermal overload protection circuits. The ADP1712/ADP1713/ADP1714 are designed to current limit when the output load reaches 500 mA (typical). When the output load exceeds 500 mA, the output voltage is reduced to maintain a constant current limit.

Thermal overload protection is included, which limits the junction temperature to a maximum of 150°C (typical). Under extreme conditions (that is, high ambient temperature and power dissipation), when the junction temperature starts to rise above 150°C, the output is turned off, reducing the output current to zero. When the junction temperature drops below 135°C (typical), the output is turned on again and output current is restored to its nominal value.

Consider the case where a hard short from OUT to ground occurs. At first the ADP1712/ADP1713/ADP1714 current limit, so that only 500 mA is conducted into the short. If self heating of the junction is great enough to cause its temperature to rise above 150°C, thermal shutdown activates, turning off the output and reducing the output current to zero. As the junction temperature cools and drops below 135°C, the output turns on and conducts 500 mA into the short, again causing the junction temperature to rise above 150°C. This thermal oscillation between 135°C and 150°C causes a current oscillation between 500 mA and 0 mA, which continues as long as the short remains at the output.

Current and thermal limit protections are intended to protect the device against accidental overload conditions. For reliable operation, device power dissipation needs to be externally limited so junction temperatures do not exceed 125°C.

## THERMAL CONSIDERATIONS

To guarantee reliable operation, the junction temperature of the ADP1712/ADP1713/ADP1714 must not exceed 125°C. To ensure the junction temperature stays below this maximum value, the user needs to be aware of the parameters that contribute to junction temperature changes. These parameters include ambient temperature, power dissipation in the power device, and thermal resistances between the junction and ambient air ( $\theta_{JA}$ ). The  $\theta_{JA}$  number is dependent on the package assembly compounds used and the amount of copper to which the GND pin of the package is soldered on the PCB. Table 5 shows typical  $\theta_{JA}$  values of the 5-lead TSOT package for various PCB copper sizes.

**Table 5.**

| Copper Size (mm <sup>2</sup> ) | $\theta_{JA}$ (°C/W) |
|--------------------------------|----------------------|
| 0 <sup>1</sup>                 | 170                  |
| 50                             | 152                  |
| 100                            | 146                  |
| 300                            | 134                  |
| 500                            | 131                  |

<sup>1</sup> Device soldered to minimum size pin traces.

The junction temperature of the ADP1712/ADP1713/ADP1714 can be calculated from the following equation:

$$T_J = T_A + (P_D \times \theta_{JA}) \quad (3)$$

where:

$T_A$  is the ambient temperature.

$P_D$  is the power dissipation in the die, given by

$$P_D = [(V_{IN} - V_{OUT}) \times I_{LOAD}] + (V_{IN} \times I_{GND}) \quad (4)$$

where:

$I_{LOAD}$  is the load current.

$I_{GND}$  is the ground current.

$V_{IN}$  and  $V_{OUT}$  are input voltage and output voltage, respectively.

Power dissipation due to ground current is quite small and can be ignored. Therefore, the junction temperature equation simplifies to the following:

$$T_J = T_A + \{[(V_{IN} - V_{OUT}) \times I_{LOAD}] \times \theta_{JA}\} \quad (5)$$

As shown in Equation 4, for a given ambient temperature, input-to-output voltage differential, and continuous load current, there exists a minimum copper size requirement for the PCB to ensure the junction temperature does not rise above 125°C. The following figures show junction temperature calculations for different ambient temperatures, load currents, input-to-output voltage differentials, and areas of PCB copper.

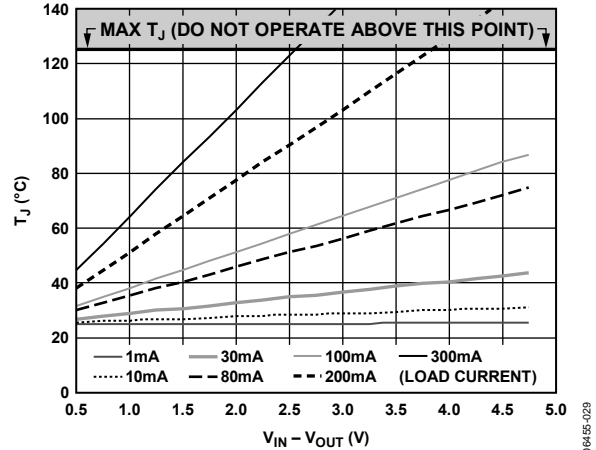

Figure 33. 500 mm<sup>2</sup> of PCB Copper,  $T_A = 25^\circ\text{C}$

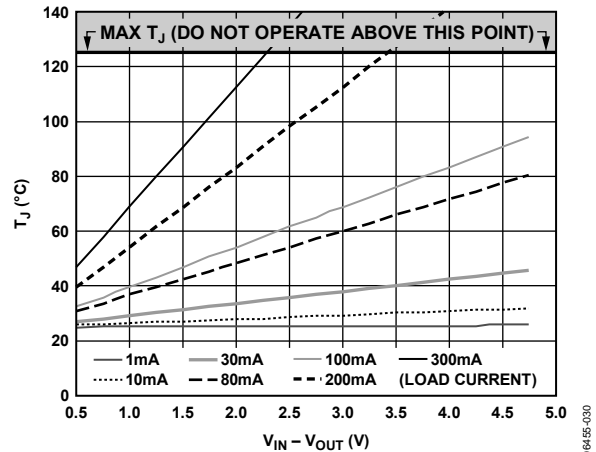

Figure 34. 100 mm<sup>2</sup> of PCB Copper,  $T_A = 25^\circ\text{C}$

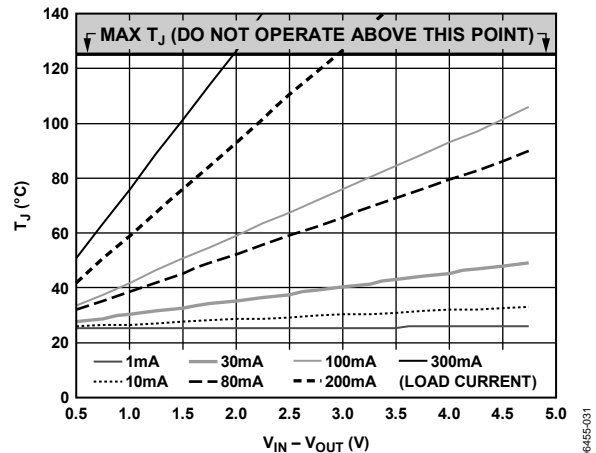

Figure 35. 0 mm<sup>2</sup> of PCB Copper,  $T_A = 25^\circ\text{C}$

# ADP1712/ADP1713/ADP1714

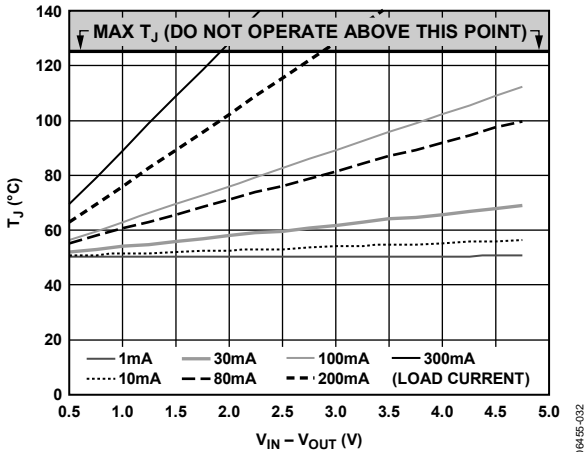

Figure 36. 500 mm<sup>2</sup> of PCB Copper, T<sub>A</sub> = 50°C

06455-032

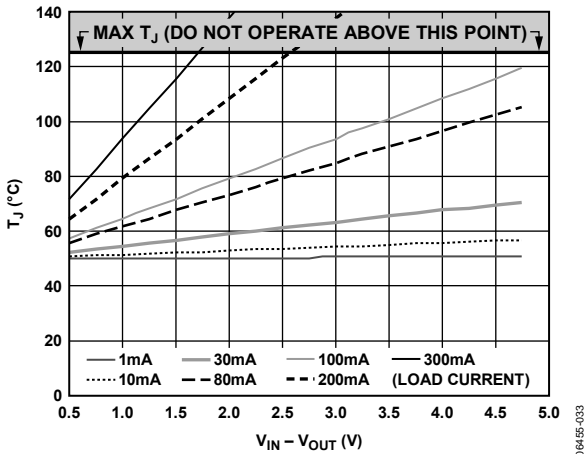

Figure 37. 100 mm<sup>2</sup> of PCB Copper, T<sub>A</sub> = 50°C

06455-033

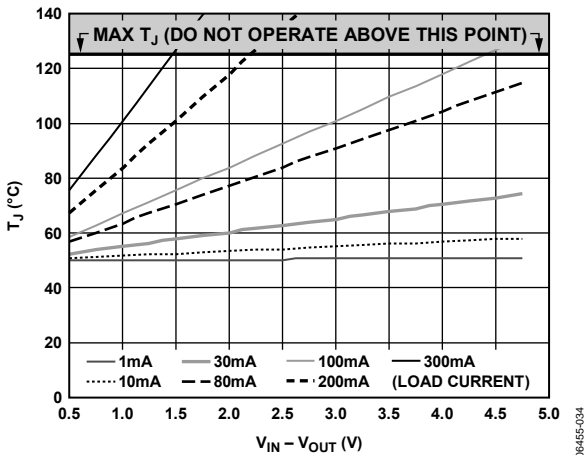

Figure 38. 0 mm<sup>2</sup> of PCB Copper, T<sub>A</sub> = 50°C

06455-034

## PRINTED CIRCUIT BOARD LAYOUT CONSIDERATIONS

Heat dissipation from the package can be improved by increasing the amount of copper attached to the pins of the ADP1712/ADP1713/ADP1714. However, as can be seen from Table 5, a point of diminishing returns eventually is reached, beyond which an increase in the copper size does not yield significant heat dissipation benefits.

Place the input capacitor as close as possible to the IN and GND pins. Place the output capacitor as close as possible to the OUT and GND pins. For the ADP1712 adjustable version, place the soft-start capacitor as close as possible to the SS pin. For the ADP1713, place the internal reference bypass capacitor as close as possible to the BYP pin. Use of 0402 or 0603 size capacitors and resistors achieves the smallest possible footprint solution on boards where area is limited.

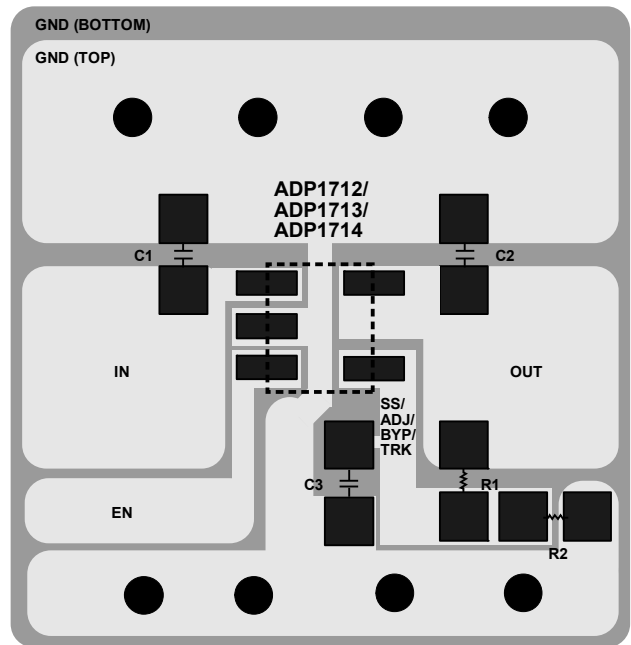
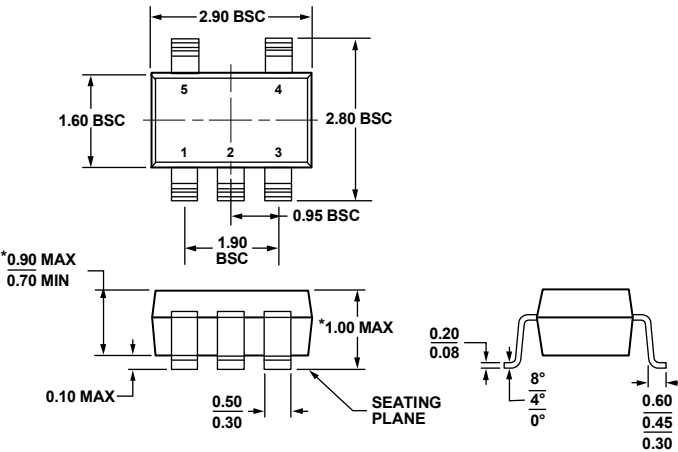

Figure 39. Example PCB Layout

06455-035

OUTLINE DIMENSIONS



\*COMPLIANT TO JEDEC STANDARDS MO-193-AB WITH THE EXCEPTION OF PACKAGE HEIGHT AND THICKNESS.

Figure 40. 5-Lead Thin Small Outline Transistor Package [TSOT] (UJ-5)  
Dimensions shown in millimeters

100708-A

ORDERING GUIDE

| Model                           | Temperature Range | Output Voltage (V) | Package Description | Package Option | Branding |
|---------------------------------|-------------------|--------------------|---------------------|----------------|----------|
| ADP1712AUJZ-0.75R7 <sup>1</sup> | -40°C to +125°C   | 0.75               | 5-Lead TSOT         | UJ-5           | L3S      |
| ADP1712AUJZ-0.8-R7 <sup>1</sup> | -40°C to +125°C   | 0.80               | 5-Lead TSOT         | UJ-5           | L3T      |
| ADP1712AUJZ-0.85R7 <sup>1</sup> | -40°C to +125°C   | 0.85               | 5-Lead TSOT         | UJ-5           | L3U      |
| ADP1712AUJZ-0.9-R7 <sup>1</sup> | -40°C to +125°C   | 0.90               | 5-Lead TSOT         | UJ-5           | L3V      |
| ADP1712AUJZ-0.95R7 <sup>1</sup> | -40°C to +125°C   | 0.95               | 5-Lead TSOT         | UJ-5           | L3W      |
| ADP1712AUJZ-1.0-R7 <sup>1</sup> | -40°C to +125°C   | 1.00               | 5-Lead TSOT         | UJ-5           | L3X      |
| ADP1712AUJZ-1.05R7 <sup>1</sup> | -40°C to +125°C   | 1.05               | 5-Lead TSOT         | UJ-5           | L3Y      |
| ADP1712AUJZ-1.1-R7 <sup>1</sup> | -40°C to +125°C   | 1.10               | 5-Lead TSOT         | UJ-5           | L3Z      |
| ADP1712AUJZ-1.15R7 <sup>1</sup> | -40°C to +125°C   | 1.15               | 5-Lead TSOT         | UJ-5           | L4H      |
| ADP1712AUJZ-1.2-R7 <sup>1</sup> | -40°C to +125°C   | 1.20               | 5-Lead TSOT         | UJ-5           | L4J      |
| ADP1712AUJZ-1.3-R7 <sup>1</sup> | -40°C to +125°C   | 1.30               | 5-Lead TSOT         | UJ-5           | L4K      |
| ADP1712AUJZ-1.5-R7 <sup>1</sup> | -40°C to +125°C   | 1.50               | 5-Lead TSOT         | UJ-5           | L4L      |
| ADP1712AUJZ-1.8-R7 <sup>1</sup> | -40°C to +125°C   | 1.80               | 5-Lead TSOT         | UJ-5           | L4M      |
| ADP1712AUJZ-2.5-R7 <sup>1</sup> | -40°C to +125°C   | 2.50               | 5-Lead TSOT         | UJ-5           | L4N      |
| ADP1712AUJZ-3.0-R7 <sup>1</sup> | -40°C to +125°C   | 3.00               | 5-Lead TSOT         | UJ-5           | L4P      |
| ADP1712AUJZ-3.3-R7 <sup>1</sup> | -40°C to +125°C   | 3.30               | 5-Lead TSOT         | UJ-5           | L4Q      |
| ADP1712AUJZ-R7 <sup>1</sup>     | -40°C to +125°C   | 0.8 to 5           | 5-Lead TSOT         | UJ-5           | L4R      |
| ADP1713AUJZ-0.75R7 <sup>1</sup> | -40°C to +125°C   | 0.75               | 5-Lead TSOT         | UJ-5           | L4U      |
| ADP1713AUJZ-0.8-R7 <sup>1</sup> | -40°C to +125°C   | 0.80               | 5-Lead TSOT         | UJ-5           | L4V      |
| ADP1713AUJZ-0.85R7 <sup>1</sup> | -40°C to +125°C   | 0.85               | 5-Lead TSOT         | UJ-5           | L4W      |
| ADP1713AUJZ-0.9-R7 <sup>1</sup> | -40°C to +125°C   | 0.90               | 5-Lead TSOT         | UJ-5           | L4X      |
| ADP1713AUJZ-0.95R7 <sup>1</sup> | -40°C to +125°C   | 0.95               | 5-Lead TSOT         | UJ-5           | L4Y      |
| ADP1713AUJZ-1.0-R7 <sup>1</sup> | -40°C to +125°C   | 1.00               | 5-Lead TSOT         | UJ-5           | L4Z      |
| ADP1713AUJZ-1.05R7 <sup>1</sup> | -40°C to +125°C   | 1.05               | 5-Lead TSOT         | UJ-5           | L50      |
| ADP1713AUJZ-1.1-R7 <sup>1</sup> | -40°C to +125°C   | 1.10               | 5-Lead TSOT         | UJ-5           | L51      |
| ADP1713AUJZ-1.15R7 <sup>1</sup> | -40°C to +125°C   | 1.15               | 5-Lead TSOT         | UJ-5           | L52      |
| ADP1713AUJZ-1.2-R7 <sup>1</sup> | -40°C to +125°C   | 1.20               | 5-Lead TSOT         | UJ-5           | L53      |

# ADP1712/ADP1713/ADP1714

| Model                           | Temperature Range | Output Voltage (V)         | Package Description   | Package Option | Branding |
|---------------------------------|-------------------|----------------------------|---|----------------|----------|
| ADP1713AUJZ-1.3-R7 <sup>1</sup> | -40°C to +125°C   | 1.30                       | 5-Lead TSOT   | UJ-5           | L54      |
| ADP1713AUJZ-1.5-R7 <sup>1</sup> | -40°C to +125°C   | 1.50                       | 5-Lead TSOT   | UJ-5           | L55      |
| ADP1713AUJZ-1.8-R7 <sup>1</sup> | -40°C to +125°C   | 1.80                       | 5-Lead TSOT   | UJ-5           | L56      |
| ADP1713AUJZ-2.5-R7 <sup>1</sup> | -40°C to +125°C   | 2.50                       | 5-Lead TSOT   | UJ-5           | L57      |
| ADP1713AUJZ-3.0-R7 <sup>1</sup> | -40°C to +125°C   | 3.00                       | 5-Lead TSOT   | UJ-5           | L58      |
| ADP1713AUJZ-3.3-R7 <sup>1</sup> | -40°C to +125°C   | 3.30                       | 5-Lead TSOT   | UJ-5           | L59      |
| ADP1714AUJZ-0.75R7 <sup>1</sup> | -40°C to +125°C   | 0.75                       | 5-Lead TSOT   | UJ-5           | L5A      |
| ADP1714AUJZ-0.8-R7 <sup>1</sup> | -40°C to +125°C   | 0.80                       | 5-Lead TSOT   | UJ-5           | L5C      |
| ADP1714AUJZ-0.85R7 <sup>1</sup> | -40°C to +125°C   | 0.85                       | 5-Lead TSOT   | UJ-5           | L5D      |
| ADP1714AUJZ-0.9-R7 <sup>1</sup> | -40°C to +125°C   | 0.90                       | 5-Lead TSOT   | UJ-5           | L5E      |
| ADP1714AUJZ-0.95R7 <sup>1</sup> | -40°C to +125°C   | 0.95                       | 5-Lead TSOT   | UJ-5           | L5F      |
| ADP1714AUJZ-1.0-R7 <sup>1</sup> | -40°C to +125°C   | 1.00                       | 5-Lead TSOT   | UJ-5           | L5G      |
| ADP1714AUJZ-1.05R7 <sup>1</sup> | -40°C to +125°C   | 1.05                       | 5-Lead TSOT   | UJ-5           | L5H      |
| ADP1714AUJZ-1.1-R7 <sup>1</sup> | -40°C to +125°C   | 1.10                       | 5-Lead TSOT   | UJ-5           | L5J      |
| ADP1714AUJZ-1.15R7 <sup>1</sup> | -40°C to +125°C   | 1.15                       | 5-Lead TSOT   | UJ-5           | L5K      |
| ADP1714AUJZ-1.2-R7 <sup>1</sup> | -40°C to +125°C   | 1.20                       | 5-Lead TSOT   | UJ-5           | L5L      |
| ADP1714AUJZ-1.3-R7 <sup>1</sup> | -40°C to +125°C   | 1.30                       | 5-Lead TSOT   | UJ-5           | L5M      |
| ADP1714AUJZ-1.5-R7 <sup>1</sup> | -40°C to +125°C   | 1.50                       | 5-Lead TSOT   | UJ-5           | L5N      |
| ADP1714AUJZ-1.8-R7 <sup>1</sup> | -40°C to +125°C   | 1.80                       | 5-Lead TSOT   | UJ-5           | L5P      |
| ADP1714AUJZ-2.5-R7 <sup>1</sup> | -40°C to +125°C   | 2.50                       | 5-Lead TSOT   | UJ-5           | L5Q      |
| ADP1714AUJZ-3.0-R7 <sup>1</sup> | -40°C to +125°C   | 3.00                       | 5-Lead TSOT   | UJ-5           | L5R      |
| ADP1714AUJZ-3.3-R7 <sup>1</sup> | -40°C to +125°C   | 3.30                       | 5-Lead TSOT   | UJ-5           | L5S      |
| ADP1712-3.3-EVALZ1 <sup>1</sup> |                   | 3.3                        | ADP1712 Fixed 3.3 V Output with Soft Start Evaluation Board |                |          |
| ADP1712-EVALZ1 <sup>1</sup>     |                   | Adjustable, but set to 1.6 | ADP1712 Adjustable Output Evaluation Board                  |                |          |
| ADP1713-3.3-EVALZ1 <sup>1</sup> |                   | 3.3                        | ADP1713 Fixed 3.3 V Output with Bypass Evaluation Board     |                |          |
| ADP1714-3.3-EVALZ1 <sup>1</sup> |                   | 3.3                        | ADP1714 Fixed 3.3 V Output with Track Mode Evaluation Board |                |          |

<sup>1</sup> Z = RoHS Compliant Part.



Компания «Океан Электроники» предлагает заключение долгосрочных отношений при поставках импортных электронных компонентов на взаимовыгодных условиях!

Наши преимущества:

- Поставка оригинальных импортных электронных компонентов напрямую с производств Америки, Европы и Азии, а так же с крупнейших складов мира;
- Широкая линейка поставок активных и пассивных импортных электронных компонентов (более 30 млн. наименований);
- Поставка сложных, дефицитных, либо снятых с производства позиций;
- Оперативные сроки поставки под заказ (от 5 рабочих дней);
- Экспресс доставка в любую точку России;
- Помощь Конструкторского Отдела и консультации квалифицированных инженеров;
- Техническая поддержка проекта, помощь в подборе аналогов, поставка прототипов;
- Поставка электронных компонентов под контролем ВП;
- Система менеджмента качества сертифицирована по Международному стандарту ISO 9001;
- При необходимости вся продукция военного и аэрокосмического назначения проходит испытания и сертификацию в лаборатории (по согласованию с заказчиком);
- Поставка специализированных компонентов военного и аэрокосмического уровня качества (Xilinx, Altera, Analog Devices, Intersil, Interpoint, Microsemi, Actel, Aeroflex, Peregrine, VPT, Syfer, Eurofarad, Texas Instruments, MS Kennedy, Miteq, Cobham, E2V, MA-COM, Hittite, Mini-Circuits, General Dynamics и др.);

Компания «Океан Электроники» является официальным дистрибьютором и эксклюзивным представителем в России одного из крупнейших производителей разъемов военного и аэрокосмического назначения «JONHON», а так же официальным дистрибьютором и эксклюзивным представителем в России производителя высокотехнологичных и надежных решений для передачи СВЧ сигналов «FORSTAR».



## JONHON

«JONHON» (основан в 1970 г.)

Разъемы специального, военного и аэрокосмического назначения:

(Применяются в военной, авиационной, аэрокосмической, морской, железнодорожной, горно- и нефтедобывающей отраслях промышленности)

«FORSTAR» (основан в 1998 г.)

ВЧ соединители, коаксиальные кабели,  
кабельные сборки и микроволновые компоненты:

(Применяются в телекоммуникациях гражданского и специального назначения, в средствах связи, РЛС, а так же военной, авиационной и аэрокосмической отраслях промышленности).



Телефон: 8 (812) 309-75-97 (многоканальный)

Факс: 8 (812) 320-03-32

Электронная почта: [ocean@oceanchips.ru](mailto:ocean@oceanchips.ru)

Web: <http://oceanchips.ru/>

Адрес: 198099, г. Санкт-Петербург, ул. Калинина, д. 2, корп. 4, лит. А