

STRADA-SQ-ME

Beam with excellent longitudinal luminance uniformity fulfilling EN13201 M-class requirements where road width is equal to or less than the pole height. Version with location pins and installation tap

TECHNICAL SPECIFICATIONS:

Dimensions	25.0 mm
Height	8.8 mm
Fastening	tape, pin, screw
ROHS compliant	yes ⓘ

MATERIAL SPECIFICATIONS:

Component	Type	Material	Colour	Finish
STRADA-SQ-ME	Single lens	PMMA	clear	
ROSE-TAPE	Tape	PU tape	black	

ORDERING INFORMATION:

Component		Qty in box	MOQ	MPQ	Box weight (kg)
CA14026_STRADA-SQ-ME	Single lens	2058	294	98	8.8
» Box size: 480 x 280 x 300 mm					



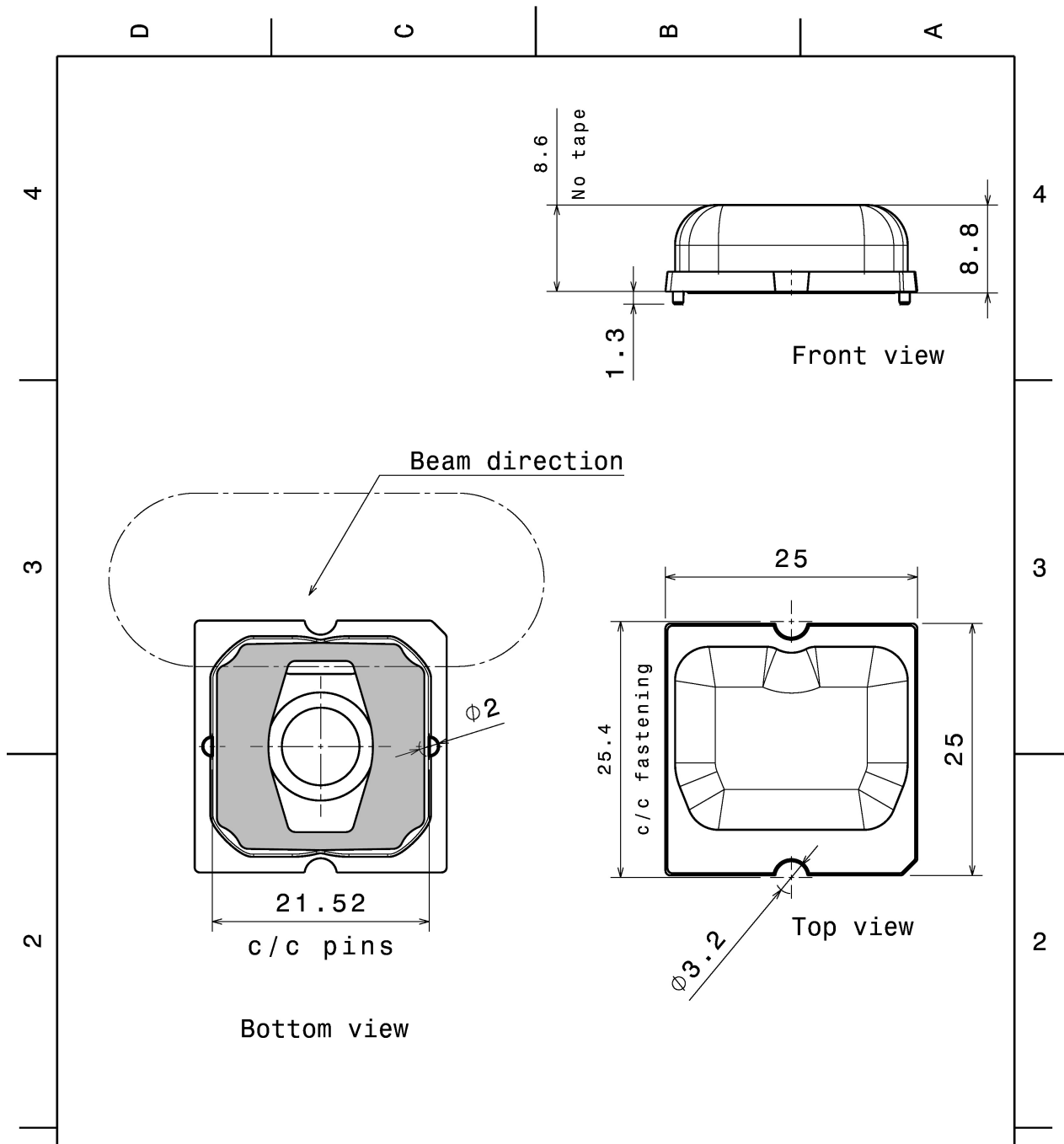

Tolerances if not otherwise shown According to DIN ISO 2768-1 Linear measures: Up to 30mm class M, otherwise class C. According to DIN ISO 2768-2 Form and position: class L		LEDiL LediL Oy Salorankatu 10 FIN 24240 SALO Finland	
THIRD ANGLE PROJECTION:		DRAWING TITLE STRADA-SQ-ME_Mechanicaldrawing	
This drawing is the property of LEDiL Oy. It may not be reproduced, copied or communicated without a written agreement with LEDiL Oy.		SIZE A4	PART NUMBER -
SCALE 2:1		WEIGHT -	SHEET 1/1

PHOTOMETRIC DATA (MEASURED):

CREE

LED MK-R
 FWHM Asymmetric
 Efficiency 93 %
 Peak intensity 0.6 cd/lm
 LEDs/each optic 1
 Light colour White
 Required components:

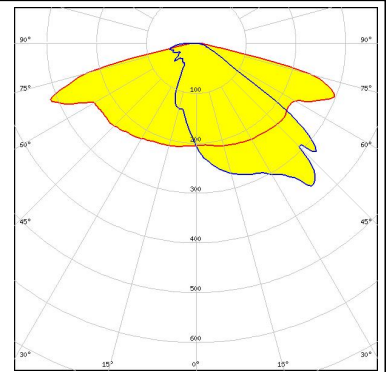

CREE

LED XHP35 HD
 FWHM Asymmetric
 Efficiency 93 %
 Peak intensity 0.9 cd/lm
 LEDs/each optic 1
 Light colour White
 Required components:

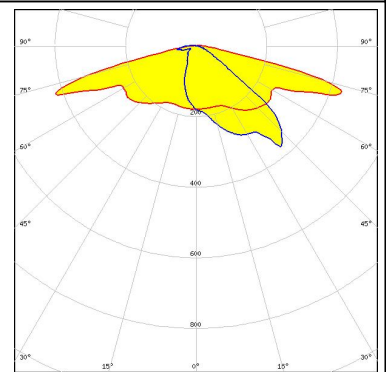

CREE

LED XHP50
 FWHM Asymmetric
 Efficiency 92 %
 Peak intensity 0.6 cd/lm
 LEDs/each optic 1
 Light colour White
 Required components:

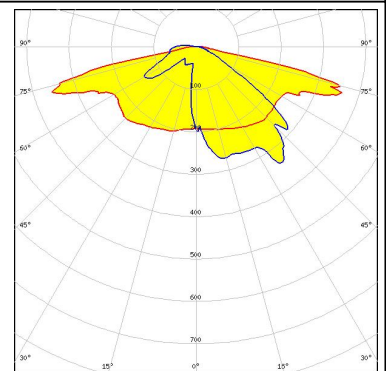

LUMILEDS

LED LUXEON M/MX
 FWHM Asymmetric
 Efficiency 92 %
 Peak intensity 0.7 cd/lm
 LEDs/each optic 1
 Light colour White
 Required components:

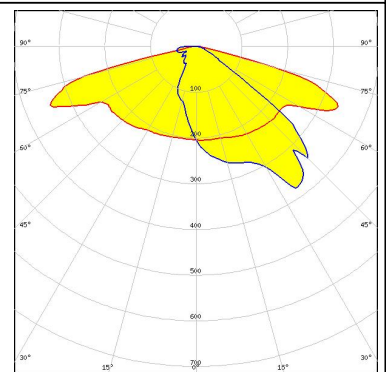

PHOTOMETRIC DATA (MEASURED):

LUMILEDS

LED LUXEON MZ
FWHM Asymmetric
Efficiency 93 %
Peak intensity 1 cd/lm
LEDs/each optic 1
Light colour White
Required components:

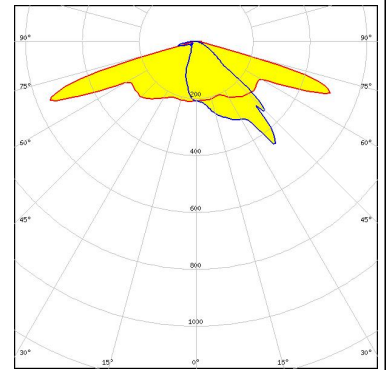

LUMILEDS

LED LUXEON XR-M linear 1x3, 1x4, 1x5
FWHM Asymmetric
Efficiency 93 %
Peak intensity 0.7 cd/lm
LEDs/each optic 1
Light colour White
Required components:

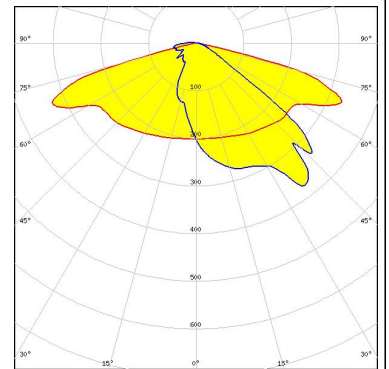

NICHIA

LED NV4x144A
FWHM Asymmetric
Efficiency 91 %
Peak intensity 0.5 cd/lm
LEDs/each optic 1
Light colour White
Required components:

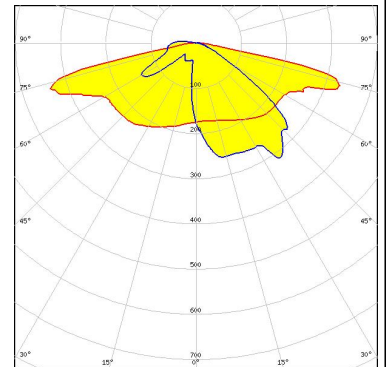

NICHIA

LED NVSW319B
FWHM Asymmetric
Efficiency 91 %
Peak intensity 0.9 cd/lm
LEDs/each optic 1
Light colour White
Required components:

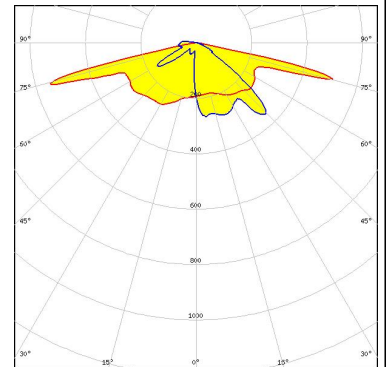

PHOTOMETRIC DATA (MEASURED):

OSRAM
Opto Semiconductors

LED Duris S10
FWHM Asymmetric
Efficiency 90 %
Peak intensity 0.5 cd/lm
LEDs/each optic 1
Light colour White
Required components:

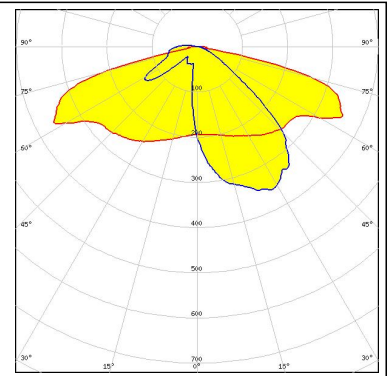

PHOTOMETRIC DATA (SIMULATED):



LED MHB-A/B
 FWHM Asymmetric
 Efficiency %
 LEDs/each optic 1
 Light colour White
 Required components:

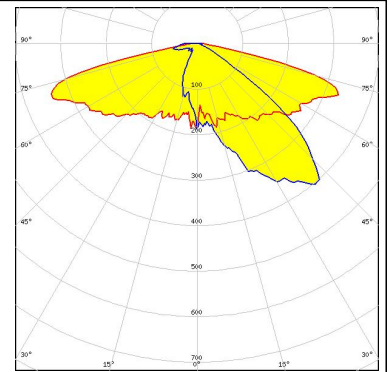

LED LUXEON 5050 Round LES
 FWHM Asymmetric
 Efficiency 94 %
 Peak intensity 0.8 cd/lm
 LEDs/each optic 1
 Light colour White
 Required components:

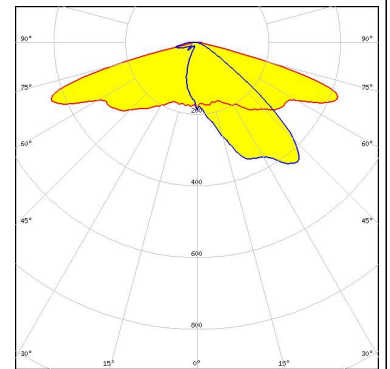

LED LUXEON M/MX
 FWHM Asymmetric
 Efficiency 78 %
 Peak intensity 0.5 cd/lm
 LEDs/each optic 1
 Light colour White
 Required components:

Transparent protective cover

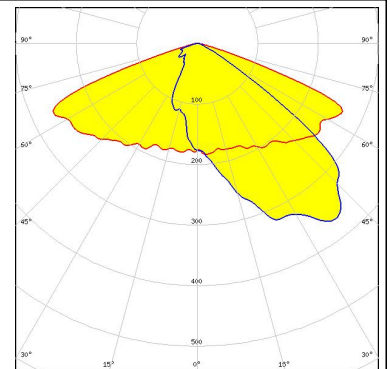

LED NVSxx19B/NVSxx19C
 FWHM Asymmetric
 Efficiency 92 %
 Peak intensity 1 cd/lm
 LEDs/each optic 1
 Light colour White
 Required components:

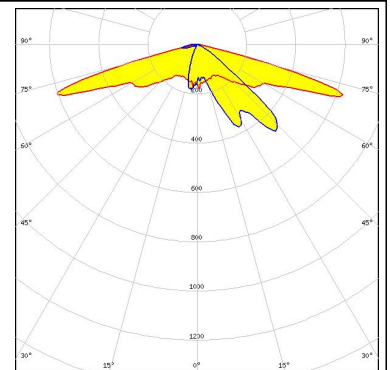

PHOTOMETRIC DATA (SIMULATED):

OSRAM
Opto Semiconductors

LED	OSCONIQ P 7070
FWHM	Asymmetric
Efficiency	91 %
Peak intensity	0.6 cd/lm
LEDs/each optic	1
Light colour	White
Required components:	

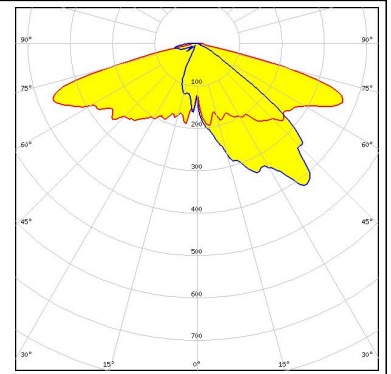

GENERAL INFORMATION:

NOTE: The typical beam angle will be changed by different color, chip size and chip position tolerance. The typical total beam angle is the full angle measured where the luminous intensity is half of the peak value.

MATERIALS:

As part of our continuous research and improvement processes, and to ensure the best possible quality and availability of our products, LEDiL reserves the right to change material grades without notice.

PRODUCT DATA USER AGREEMENT AND DISCLAIMER:

The measured data in the provided downloadable LEDiL Product Datasheets and Mechanical 2D-Drawings is rounded and provided as reference for planning. LEDiL Oy's optical specifications have been verified by conducting performance testing of the products in accordance with the company's quality system. The reported data are averaged results of multiple measurements with typical variation. LEDiL Oy reserves the right to without prior notification make changes and improvements to its products.

LEDiL Oy assumes neither warranty, nor guarantee nor any other liability of any kind for the contents and correctness of the provided data. The provided data has been generated with highest diligence but the provided data may in reality not represent the complete possible variation range of all intrinsic parameters. Therefore, in certain cases a deviation from the provided data could occur.

LEDiL Oy reserves the right to undertake technical changes of its products without further notification which could lead to changes in the provided data. LEDiL Oy assumes no liability of any kind for the possible deviation from any provided data or any other damage resulting from the usage of the provided data.

The user agrees to this disclaimer and user agreement with the download or usage of the provided files.

LEDiL Oy

Joensuunkatu 13
FI-24240 SALO
Finland

LEDiL Inc.

228 West Page Street
Suite D
Sycamore IL 60178
USA

Local sales and technical support

[www.ledil.com/
where_to_buy](http://www.ledil.com/where_to_buy)

Shipping locations

Salo, Finland
Hong Kong, China

Distribution Partners

[www.ledil.com/
where_to_buy](http://www.ledil.com/where_to_buy)

Компания «Океан Электроники» предлагает заключение долгосрочных отношений при поставках импортных электронных компонентов на взаимовыгодных условиях!

Наши преимущества:

- Поставка оригинальных импортных электронных компонентов напрямую с производств Америки, Европы и Азии, а так же с крупнейших складов мира;
- Широкая линейка поставок активных и пассивных импортных электронных компонентов (более 30 млн. наименований);
- Поставка сложных, дефицитных, либо снятых с производства позиций;
- Оперативные сроки поставки под заказ (от 5 рабочих дней);
- Экспресс доставка в любую точку России;
- Помощь Конструкторского Отдела и консультации квалифицированных инженеров;
- Техническая поддержка проекта, помощь в подборе аналогов, поставка прототипов;
- Поставка электронных компонентов под контролем ВП;
- Система менеджмента качества сертифицирована по Международному стандарту ISO 9001;
- При необходимости вся продукция военного и аэрокосмического назначения проходит испытания и сертификацию в лаборатории (по согласованию с заказчиком);
- Поставка специализированных компонентов военного и аэрокосмического уровня качества (Xilinx, Altera, Analog Devices, Intersil, Interpoint, Microsemi, Actel, Aeroflex, Peregrine, VPT, Syfer, Eurofarad, Texas Instruments, MS Kennedy, Miteq, Cobham, E2V, MA-COM, Hittite, Mini-Circuits, General Dynamics и др.);

Компания «Океан Электроники» является официальным дистрибьютором и эксклюзивным представителем в России одного из крупнейших производителей разъемов военного и аэрокосмического назначения «JONHON», а так же официальным дистрибьютором и эксклюзивным представителем в России производителя высокотехнологичных и надежных решений для передачи СВЧ сигналов «FORSTAR».



JONHON

«JONHON» (основан в 1970 г.)

Разъемы специального, военного и аэрокосмического назначения:

(Применяются в военной, авиационной, аэрокосмической, морской, железнодорожной, горно- и нефтедобывающей отраслях промышленности)

«FORSTAR» (основан в 1998 г.)

ВЧ соединители, коаксиальные кабели, кабельные сборки и микроволновые компоненты:

(Применяются в телекоммуникациях гражданского и специального назначения, в средствах связи, РЛС, а так же военной, авиационной и аэрокосмической отраслях промышленности).



Телефон: 8 (812) 309-75-97 (многоканальный)

Факс: 8 (812) 320-03-32

Электронная почта: ocean@oceanchips.ru

Web: <http://oceanchips.ru/>

Адрес: 198099, г. Санкт-Петербург, ул. Калинина, д. 2, корп. 4, лит. А