

User Guide for
FEBFL7734_L55H008A
Evaluation Board

8.6 W LED Driver at High Line

Featured Fairchild Product:
FL7734MX

*Direct questions or comments
about this evaluation board to:
“Worldwide Direct Support”*

Fairchild Semiconductor.com

Table of Contents

1. Introduction.....	3
1.1. General Description of FL7734MX.....	3
1.2. Controller Features.....	3
1.3. Controller Internal Block Diagram	4
2. Evaluation Board Specifications.....	5
3. Evaluation Board Photographs	6
4. Evaluation Board Printed Circuit Board (PCB).....	7
5. Evaluation Board Schematic.....	8
6. Evaluation Board Bill of Materials (BOM)	9
7. Transformer Design	11
8. Evaluation Board Performance.....	12
8.1. Startup.....	12
8.2. Operation Waveforms.....	13
8.3. Constant-Current Regulation	14
8.4. Short- / Open-LED Protections.....	15
8.5. Secondary Diode / Sensing Resistor Short Protection.....	17
8.6. Efficiency.....	19
8.7. Power Factor (PF) & Total Harmonic Distortion (THD)	20
8.8. Dimming Operation	21
8.9. Operating Temperature	25
8.10. Electromagnetic Interference (EMI).....	26
9. Revision History	27

This user guide supports the evaluation board for the FL7734MX. It should be used in conjunction with the FL7734MX datasheet as well as Fairchild's application notes and technical support team. Please visit Fairchild's website at www.fairchildsemi.com.

1. Introduction

This document describes a high performance phase-cut dimming LED driver solution with excellent dimmer compatibility. The input voltage range of the LED driver board is $198 V_{RMS} \sim 264 V_{RMS}$ and there is one DC output with a constant current of 360 mA at 24 V. Also in this document is a general description of the FL7734MX, the power supply solution specification, schematic, bill of materials, and typical operating characteristics.

1.1. General Description of FL7734MX

The FL7734 is a highly integrated PWM controller with advanced Primary-Side-Regulation (PSR) technique to minimize components in low power LED lighting solutions. Using the innovative TRUECURRENT® technology for tight constant current control, it enables design with Constant Current (CC) tolerance of less than $\pm 1\%$ over universal line voltage range to meet stringent LED brightness requirements. FL7734 operates with all types of phase cut dimmers. Phase cut dimming is managed smoothly by Fairchild's proprietary constant input current control, switching mode control and bleeding current control to achieve excellent dimmer compatibility without visible flicker. The controller can automatically detect when there is no dimmer connected. In non dimming mode, the operating mode is set to optimize Power Factor (PF) and Total Harmonic Discharge (THD) by enabling linear frequency control and voltage mode control with Discontinuous Conduction Mode (DCM) operation. An external bleeding MOSFET also acts as the high-voltage startup circuit to implement fast startup and high system efficiency. The FL7734 also provides powerful protections, such as LED open / short, sensing resistor shorted, and over-temperature for high system reliability.

1.2. Controller Features

High Performance

- Excellent Dimmer Compatibility by Active Dimming Control
- Programmable Dimming Curve and Input Current Management
- Constant LED Current Regulation in Large Phase Angle Range
- Cost-Effective Solution without Input Bulk Capacitor and Feedback Circuitry
- Power Factor Correction in Non-Dimming Mode
- Excellent CC Tolerance:
 - $< \pm 0.14\%$ Over the range of $\pm 10\%$ Input Line Voltage Variation
- Fast Startup utilizing Bleeding Circuit
 - < 0.1 s at the Max. Dimmer Phase Angle
 - < 0.5 s at the Min. Dimmer Phase Angle

High Reliability

- LED Short / Open Protection
- Output Diode Short Protection
- Sensing Resistor Short / Open Protection
- V_{DD} Over-Voltage Protection (OVP)
- V_{DD} Under-Voltage Lockout (UVLO)
- Over-Temperature Protection (OTP)
- All Protections are Auto Restart
- Cycle-by-Cycle Current Limit

1.3. Controller Internal Block Diagram

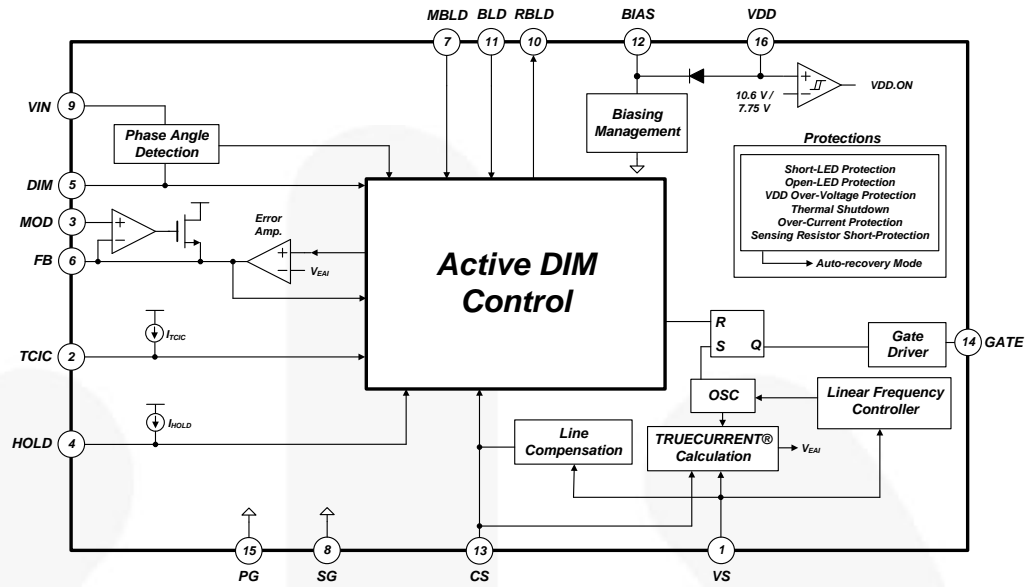

Figure 1. Block Diagram

2. Evaluation Board Specifications

Table 1. Evaluation Board Specifications for LED Lighting Bulb

Description		Symbol	Value	Comments
Input	Voltage	$V_{IN.MIN}$	198 V _{AC}	Minimum AC Input Voltage
		$V_{IN.MAX}$	230 V _{AC}	Maximum AC Input Voltage
		$V_{IN.NOMINAL}$	264 V _{AC}	Nominal AC Input Voltage
	Frequency	f_{IN}	60 Hz / 50 Hz	Line Frequency
Output	Voltage	$V_{OUT.MIN}$	21 V	Minimum Output Voltage
		$V_{OUT.MAX}$	27 V	Maximum Output Voltage
		$V_{OUT.NOMINAL}$	24 V	Nominal Output Voltage
	Current	$I_{OUT.NOMINAL}$	360 mA	Nominal Output Current
		CC Deviation		< ±0.14%
			< ±0.56%	Output Voltage Change: 21~27 V
Efficiency		Eff_{198VAC}	83.7%	Efficiency at 198 V _{AC} Input Voltage
		Eff_{230VAC}	83.9%	Efficiency at 230 V _{AC} Input Voltage
		Eff_{264VAC}	83.4%	Efficiency at 264 V _{AC} Input Voltage
PF/THD		PF / THD _{198VAC}	0.97 / 9.9%	PF/THD at 198 V _{AC} Input Voltage
		PF / THD _{230VAC}	0.96 / 11.4%	PF/THD at 230 V _{AC} Input Voltage
		PF / THD _{264VAC}	0.95 / 13.7%	PF/THD at 264 V _{AC} Input Voltage
Temperature	FL7734MX	$T_{FL7734MX}$	66.9°C	Open-Frame Condition ($T_A = 25^\circ C$) FL7734MX Temperature
	Primary MOSFET	T_{MOSFET}	63.1°C	Primary MOSFET Temperature
	Secondary Diode	T_{DIODE}	66.8°C	Secondary Diode Temperature
	Transformer	$T_{TRANSFORMER}$	66.1°C	Transformer Temperature

3. Evaluation Board Photographs

Dimensions: 62.1 mm (L) x 28 mm (W) x 22 mm (H)

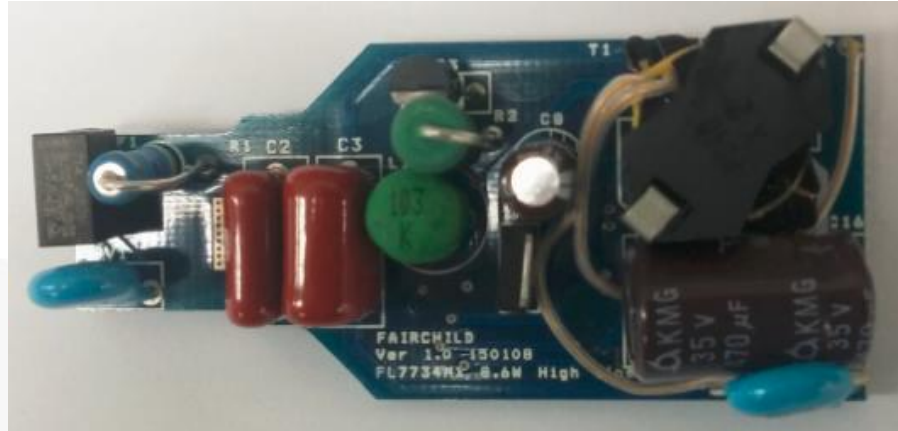

Figure 2. Top View

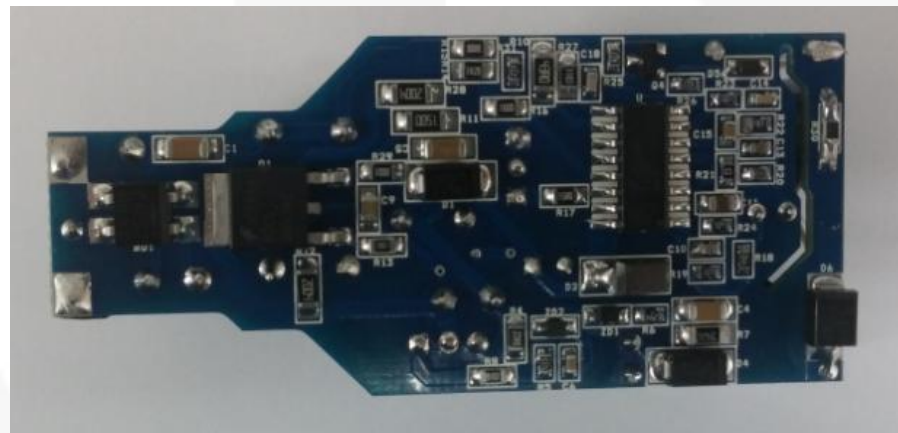

Figure 3. Bottom View

5. Evaluation Board Schematic

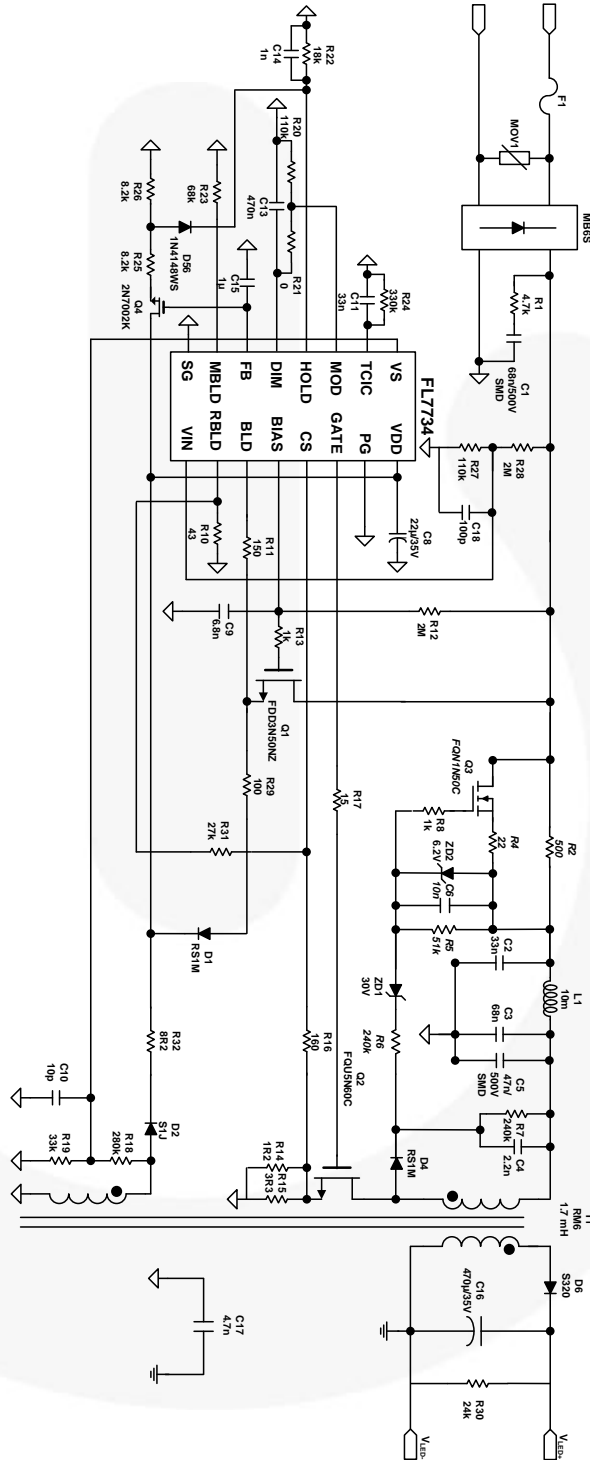

Figure 6. Schematic



6. Evaluation Board Bill of Materials (BOM)

Item No.	Part Reference	Part Number	Description	Manufacturer
1	F1	SS-5-1A	1 A/250 V Fuse	Busmann
2	MOV1	SVC 471 D-07A	Metal Oxide Varistor	Samwha
3	BD1	MB6S	600 V/0.5 A SOIC-4	Fairchild
4	R1	MOR 1W TC 4.7K	Metal Oxide Film Resistor RSD Type J 4.7 k Ω /1 W R-Forming	ABC
5	R2	MOR 2W TC 500R	Metal Oxide Film Resistor RSD Type J 500 Ω /2 W R-Forming	ABC
6	R4	RC0805JR-0722RL	22 Ω SMD Resistor 2012 F 1/4 W	Yageo
7	R5	RC0603 JR-0751KL	51k Ω SMD Resistor 1608 F 1/16 W	Yageo
8	R7	RC1206 JR-07240KL	240 k Ω SMD Resistor 3216 F 1/4 W	Yageo
9	R6	RC0603 JR-07240KL	240 k Ω SMD Resistor 1608 F 1/16 W	Yageo
10	R8	RC0805 JR-071KL	1 k Ω SMD Resistor 2012 F 1/8 W	Yageo
11	R10	RC1206 JR-0743RL	43 Ω SMD Resistor 3216 F 1/4 W	Yageo
12	R11	RC1206 JR-07150RL	150 Ω SMD Resistor 3216 F 1/4 W	Yageo
13	R12	RC1206 JR-072ML	2 M Ω SMD Resistor 3216 F 1/4 W	Yageo
14	R13	RC0805 JR-071KL	1 k Ω SMD Resistor 2012 F 1/8W	Yageo
15	R14	RC0805 JR-071R2L	1R2 SMD Resistor 2012 1/4 W F	Yageo
16	R15	RC0805 JR-073R3L	3R3 SMD Resistor 2012 1/4 W F	Yageo
17	R16	RC0805 JR-07160RL	160 Ω SMD Resistor 2012 F 1/4 W	Yageo
18	R17	RC0805 JR-0715RL	15 Ω SMD Resistor 2012 F 1/4 W	Yageo
19	R18	RC0603 JR-07280KL	280 k SMD Resistor 1608 F 1/16 W	Yageo
20	R19	RC0603 JR-0733KL	33 k SMD Resistor 1608 F 1/16 W	Yageo
21	R20	RC0603 JR-07110KL	110 k Ω SMD Resistor 1608 F 1/16 W	Yageo
22	R21	RC0603 JR-070R0L	0 Ω SMD Resistor 1608 F 1/16 W	Yageo
23	R22	RC0603 JR-0718KL	18 k SMD Resistor 1608 F 1/16 W	Yageo
24	R23	RC0603 JR-0768KL	68 k Ω SMD Resistor 1608 F 1/16 W	Yageo
25	R24	RC0603 JR-07330KL	330 k Ω SMD Resistor 1608 F 1/16 W	Yageo
26	R25	RC0603 JR-078R2KL	8.2 k SMD Resistor 1608 F 1/16 W	Yageo
27	R26	RC0603 JR-078R2KL	8.2 k SMD Resistor 1608 F 1/16 W	Yageo
28	R27	RC0805 JR-07110KL	110 k Ω SMD Resistor 2012 F 1/4 W	Yageo
29	R28	RC1206 JR-072ML	2M Ω SMD Resistor 3216 F 1/4 W	Yageo
30	R29	RC0805 JR-07100RL	100 Ω SMD Resistor 2012 1/4 W F	Yageo
31	R30	RC0805 JR-0724KL	24 k SMD Resistor 2012 F 1/4 W	Yageo
32	R31	RC0603 JR-0727KL	27 k SMD Resistor 1608 F 1/16 W	Yageo
33	R32	RC0805 JR-078R2L	8.2 Ω SMD Resistor 2012 F 1/4 W	Yageo
34	C1	C1206V683KCRCTU	68 nF/500 V SMD Capacitor 3216 X7R	Kemet
35	C2	MPE 630V333	MPE33 nF/630 V 12.5 x 10.0 x 5.0 mm	Sungho Electronics
36	C3	MPE 630V683	MPE 68 nF/630 V 12.5 x 10.0 x 5.0 mm	Sungho Electronics
37	C5	C1206V473KCRCTU	47 nF/500 V SMD Capacitor 3216 X7R	Kemet
38	C4	C1206C222KDRCTU	2.2 nF/1 kV SMD Capacitor 3216	Kemet



BOM (Continued)

Item No.	Part Reference	Part Number	Description	Manufacturer
39	C6	GRM1885C1E103JA01#	10 nF/16 V SMD Capacitor 1608 COG	Murata
40	C8	KMG 22 μ F35V	KMG series 22 μ F/35 V D5 X H11 105°C Electrolytic Capacitor	Samyoung
41	C9	GRM2192C1H682JA01#	6.8 nF/50 V SMD Capacitor 2012 CH	Murata
42	C10	C0603C100K8GACTU	10 pF/10 V SMD Capacitor 1608 NP0	Kemet
43	C11	GRM21A1X1H333JA39#	33 nF/50 V SMD Capacitor 2012 SL	Murata
44	C13	GRM188B11A474KA61#	470 nF/10 V SMD Capacitor 1608 B	Murata
45	C14	GRM1881X1E102JA01#	1 nF/10 V SMD Capacitor 1608 SL	Murata
46	C15	GRM185D71A105KE36#	1 μ F/10 V SMD Capacitor 1608 X7T	Murata
47	C16	KMG 470 μ F35V	KMG Series 470 μ F/35 V D10 X H12.5 105°C Electrolytic Capacitor	Samyoung
48	C17	SCF2E472M14DW7	Y Cap 4700 pF	Samwha Capacitor
49	C18	GRM1882C1H101JA01#	SMD Capacitor CH 100 pF/50 V	
50	L1	R06103KT00	Radial inductor 10 mH size Φ 6.5 mm X H7.5 mm Molding Color Green	Bosung
51	T1	RM6 core	Core RM6 PC40 Bobbin BRM6-716CPFR	TDK
52	D1	RS1M	1000 V/1.0 A SMA Package Fast Recovery Diode	Fairchild
53	D2	S1J	600 V/1.0 A SMA Package General Purpose Diode	Fairchild
54	D4	RS1M	1000 V/1.0 A SMA Package Fast Recovery Diode	Fairchild
55	D56	1N4148WS	100 V/0.3 A SOD-323 Package General Purpose Diode	Fairchild
56	D6	S320	200 V/3.0 A SMB Package Schottky Rectifier	Fairchild
57	ZD1	MM3Z30B	30 V Zener Diode SOD-323	Fairchild
58	ZD2	MM3Z6V2B	6.2 V Zener Diode SOD-323	Fairchild
59	Q1	FDD3N50NZ	N-ch Mosfet 500 V/3 A D-Pak	Fairchild
60	Q2	FQU5N60C	N-ch Mosfet 600 V/5 A I-Pak	Fairchild
61	Q3	FQN1N50C	N-ch Mosfet 500 V/0.38 A TO-92	Fairchild
62	Q4	2N7002K	N-ch Mosfet 60 V/0.3 A SOT-23	Fairchild
63	U	FL7734MX	Triac Dimmable LED Driver IC	Fairchild

7. Transformer Design

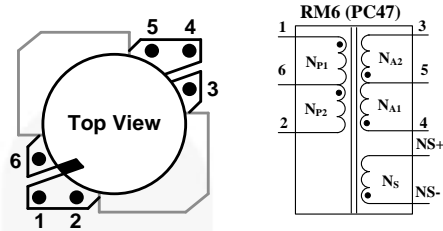

Figure 7. Transformer Bobbin Structure and Pin Configuration

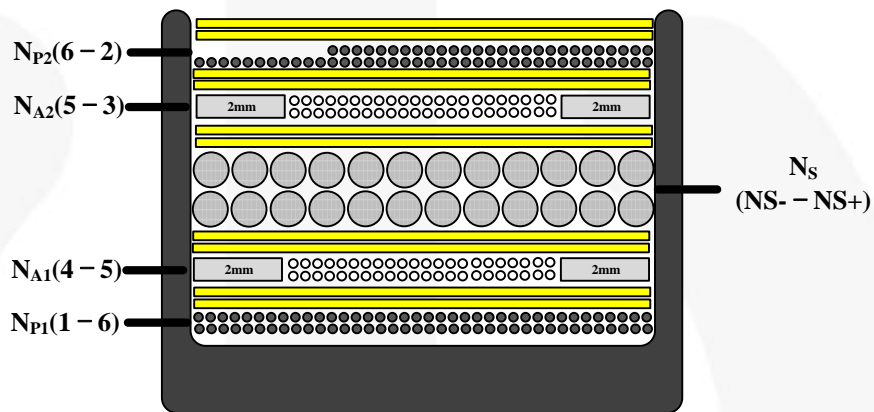

Figure 8. Transformer Winding Structure

Table 2. Winding Specifications

No.	Winding	Pin (S → F)	Wire	Turns	Winding Method
1	N_{P1}	1 → 6	0.13φ	73 Ts	Solenoid Winding
2	Insulation: Polyester Tape t = 0.025 mm, 2-Layer				
3	N_{A1}	4 → 5	0.13φ	20 Ts	Solenoid Winding
4	Insulation: Polyester Tape t = 0.025 mm, 2-Layer				
5	N_S	NS- → NS+	0.2φ (TIW)	44 Ts	Solenoid Winding
6	Insulation: Polyester Tape t = 0.025 mm, 2-Layer				
7	N_{A2}	5 → 3	0.13φ	20 Ts	Solenoid Winding
8	Insulation: Polyester Tape t = 0.025 mm, 2-Layer				
9	N_{P2}	6 → 2	0.13φ	51 Ts	Solenoid winding
10	Insulation: Polyester Tape t = 0.025 mm, 2-Layer				

Table 3. Electrical Characteristics

	Pins	Specifications	Remark
Inductance	6 – 2	1.7 mH ±10%	60 kHz, 1 V
Leakage	6 – 2	30 μH	60 kHz, 1 V, Short All Output Pins

8. Evaluation Board Performance

Table 4. Test Condition & Equipment List

Ambient Temperature	$T_A = 25^\circ\text{C}$
Test Equipment	AC Power Source: PCR500L by Kikusui Power Analyzer: PZ4000000 by Yokogawa Electronic Load: PLZ303WH by KIKUSUI Multi Meter: 2002 by KEITHLEY, 45 by FLUKE Oscilloscope: 104Xi by LeCroy Thermometer: Thermal CAM SC640 by FLIR SYSTEMS LED: EHP-AX08EL/GT01H-P03 (3 W) by Everlight

8.1. Startup

Figure 9 shows the overall startup performance at rated output load when no dimmer is connected. The output load current starts flowing at least 0.06 s after the AC input power switch turns on for input voltage 230 V_{AC} condition. CH1: V_{IN} (100 V / div), CH2: V_{DD} (10 V / div), CH3: V_{CS} (500 mV / div), CH4: I_{LED} (100 mA / div), Time Scale: (100 ms / div), Load: 8 series-connected LEDs.

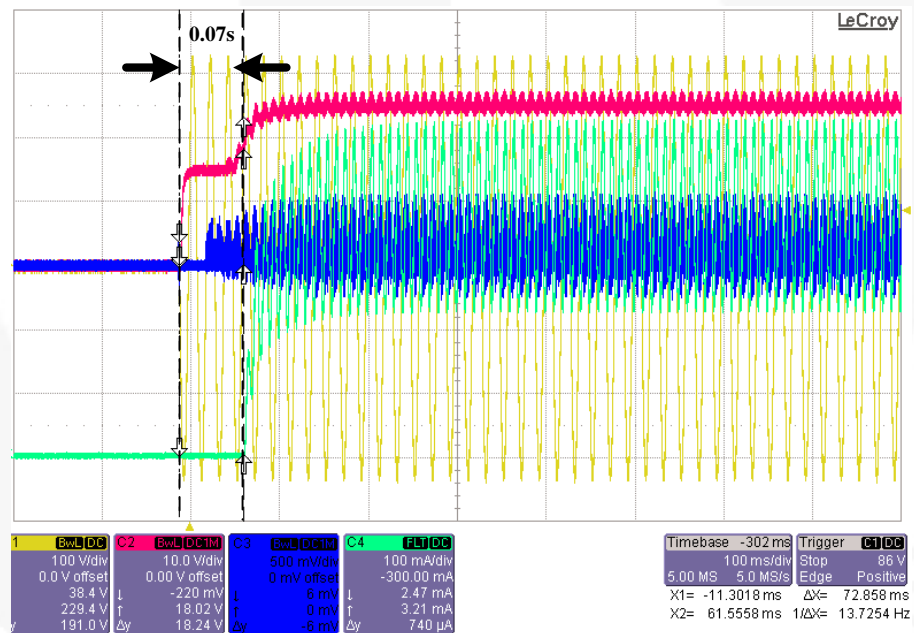

Figure 9. V_{IN} = 230 V_{AC} / 50 Hz

8.2. Operation Waveforms

Figure 10 through Figure 12 show AC input and output waveforms at rated output load. CH1: V_{IN} (100 V / div), CH2: V_{CS} (500 mV / div), CH3: I_{IN} (100 mA / div), CH4: I_{LED} (200 mA / div), Time Scale: (5 ms / div), Load: 8 series-connected LEDs.

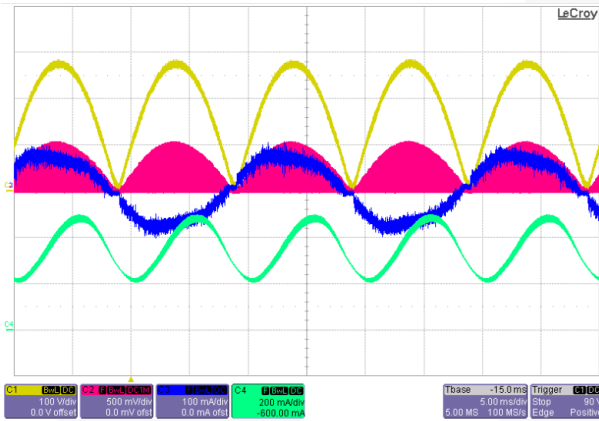

Figure 10. $V_{IN} = 198 V_{AC} / 50 \text{ Hz}$

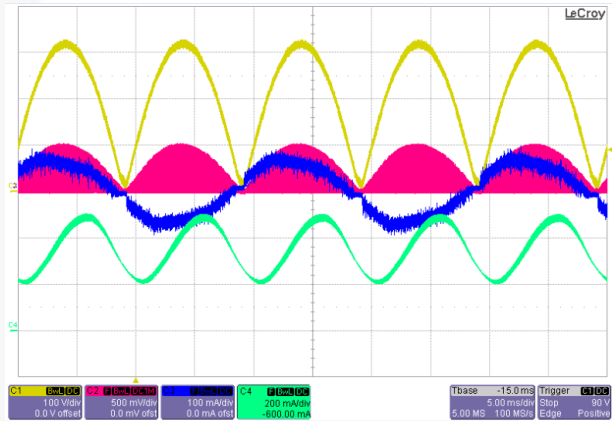

Figure 11. $V_{IN} = 230 V_{AC} / 50 \text{ Hz}$

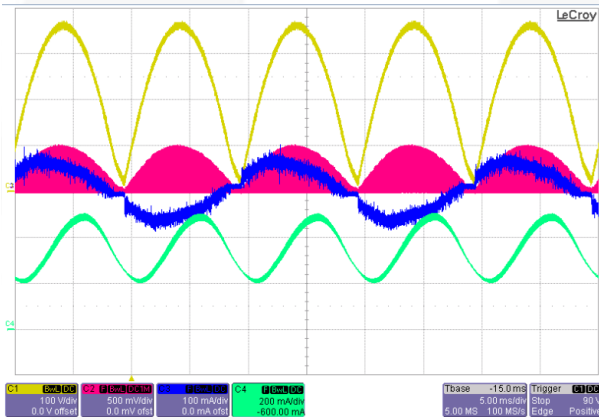

Figure 12. $V_{IN} = 264 V_{AC} / 50 \text{ Hz}$

8.3. Constant-Current Regulation

Output current deviation over the output voltage ranges, from 21 V to 27 V, is less than $\pm 0.56\%$ at each line voltage. Line regulation at the rated output voltage (24 V) is less than $\pm 0.14\%$. The results were measured with Electronic Load [CR Mode].

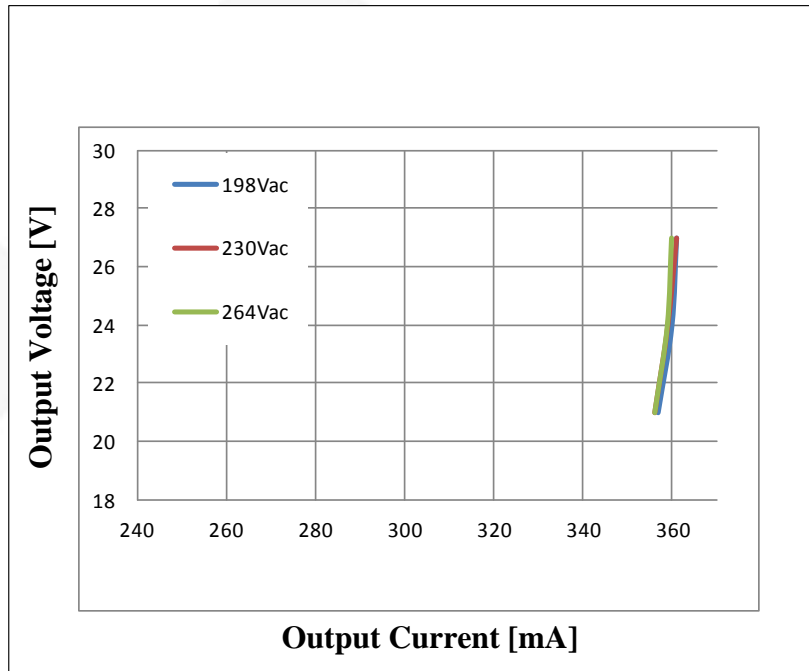

Figure 13. Constant-Current Regulation

Table 5. Constant-Current Regulation by Output Voltage Change (21 ~ 27 V)

Input Voltage	Min. Current [mA]	Max. Current [mA]	Tolerance
198 V _{AC} [60 Hz]	360	361	$\pm 0.14\%$
230 V _{AC} [60 Hz]	357	361	$\pm 0.56\%$
264 V _{AC} [60 Hz]	357	360	$\pm 0.42\%$

Table 6. Constant-Current Regulation by Line Voltage Change (198 ~ 264 V_{AC})

Output Voltage	198 V _{AC} [50 Hz]	230 V _{AC} [50 Hz]	264 V _{AC} [50 Hz]	Tolerance
27 V	360 mA	361 mA	360 mA	$\pm 0.14\%$
24 V	360 mA	360 mA	359 mA	$\pm 0.14\%$
21 V	358 mA	357 mA	357 mA	$\pm 0.14\%$

8.4. Short- / Open-LED Protections

Figure 14 shows a waveform for the protection and AR operation when the LED is shorted. Once the LED short occurs, SLP is triggered and the controller then shuts down the switching MOSFET. After 4 s, the Startup sequence reinitiates. This behavior lasts until the fault condition is removed. Systems can restart automatically when normal condition resumes at least 4 seconds. CH1: V_{IN} (100 V / div), CH3: V_{GATE} (10 V / div), CH4: V_{OUT} (5 V / div), Time Scale: (1 s / div), Load: 8 series-connected LEDs.

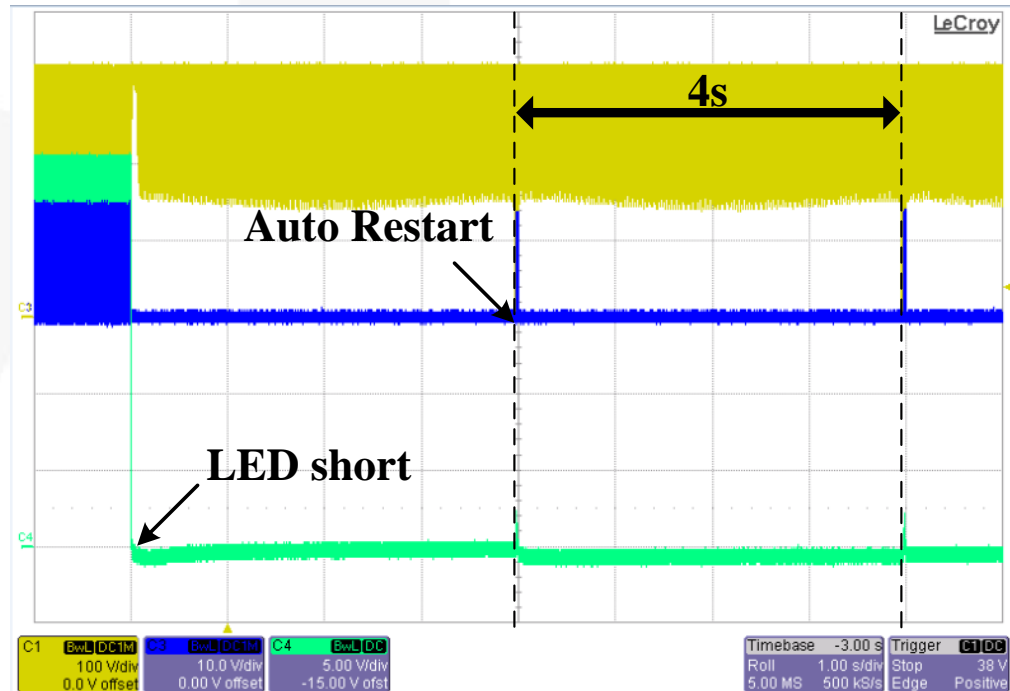

Figure 14. $V_{IN} = 230 V_{AC} / 50 Hz$

Figure 15 shows a waveform for the protection and AR operation when the LED is opened. Once the LED load is disconnected, V_S OVP or V_{DD} OVP is triggered and the controller then shuts down the switching MOSFET. After 4 s, Startup sequence reinitiates. This behavior lasts until the fault condition is removed. Systems can restart automatically when normal condition resumes at least 4 seconds. CH1: V_{IN} (100 V / div), CH3: V_{GATE} (10 V / div), CH4: V_{OUT} (5 V / div), Time Scale: (1 s / div), Load: 8 series-connected LEDs.

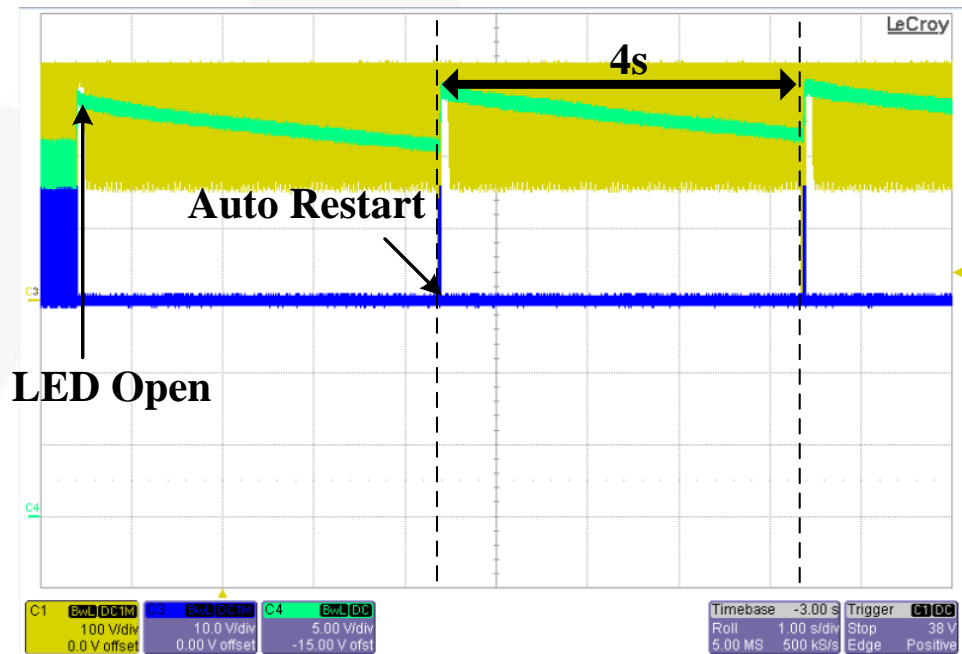

Figure 15. $V_{IN} = 230 V_{AC} / 50 Hz$

If the LED load is re-connected after an open-LED condition, the output capacitor is quickly discharged through the LED load and the inrush current due to the discharge could destroy LED load.

8.5. Secondary Diode / Sensing Resistor Short Protection

Figure 16 shows a waveform for the protection operation when the secondary diode is shorted. V_{CS} is monitored during the gate turn-on time to detect over-current except for LEB time. Once V_{CS} goes higher than V_{CS-OC} (1.8 V) after the LEB time, OCP is triggered and the controller then shuts down the switching MOSFET. I_{peak} amplitude can be adjusted by using different magnetizing inductance. CH1: V_{IN} (100 V / div), CH2: V_{CS} (500 mV / div), CH3: V_{GATE} (10 V / div), Time Scale: (10 ms / div), Load: 8 series-connected LEDs.

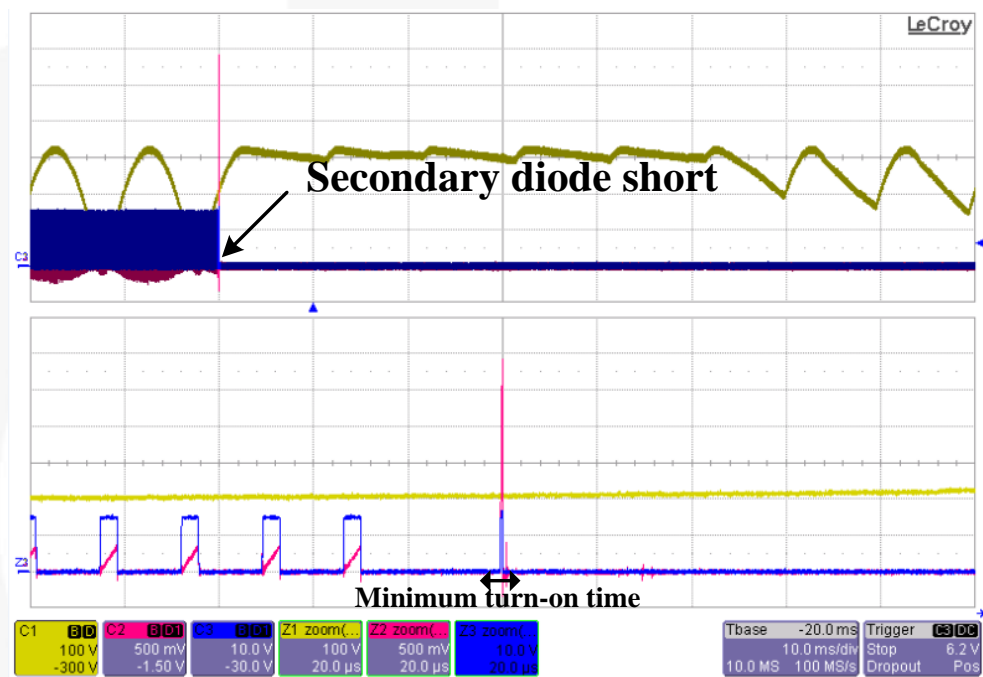

Figure 16. $V_{IN} = 230 V_{AC} / 50 Hz$

After 4 s, startup operation starts again. This behavior lasts until the fault condition is removed. Systems can restart automatically when normal condition resumes at least 4 seconds.

Figure 17 shows a waveform for the protection operation when the sensing resistor is shorted. If V_{CS} doesn't reach $V_{CS-SRSP}$ (0.1 V) within the initial two switching operations during the Startup period, SRSP is triggered and the controller then shuts down the switching MOSFET. CH1: V_{IN} (100 V / div), CH2: V_{CS} (500 mV / div), CH3: V_{GATE} (10 V / div), Time Scale: (10 ms / div), Load: 8 series-connected LEDs.

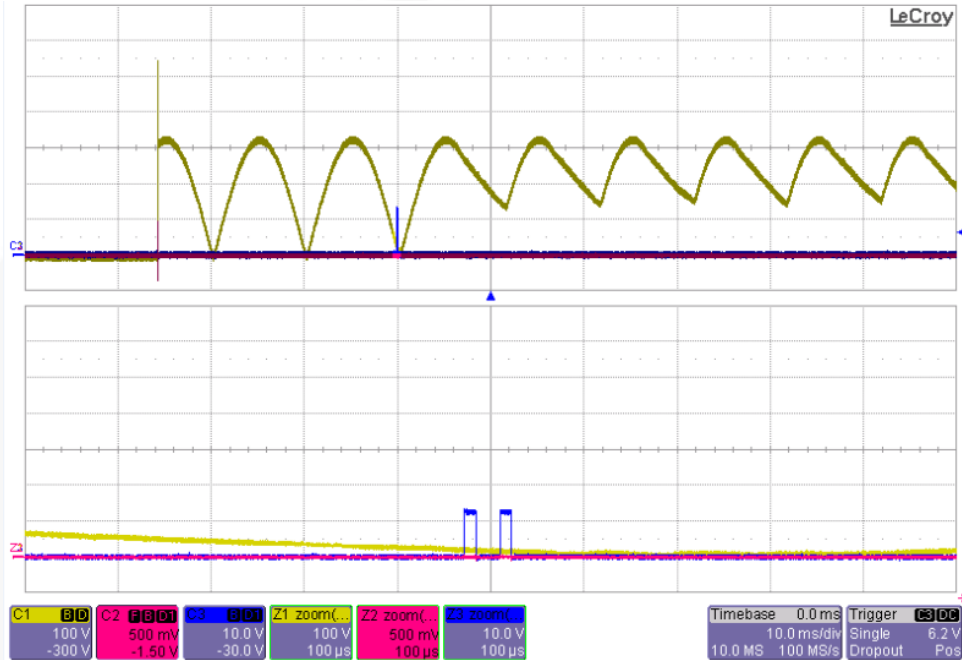

Figure 17. $V_{IN} = 230 V_{AC} / 50 Hz$

After 4 s, Startup operation starts again. This behavior lasts until the fault condition is removed. Systems can restart automatically when normal condition resumes at least 4 seconds.

8.6. Efficiency

System efficiency is over 83% from 198 ~ 264 V_{AC}. The results were measured using actual, rated LED loads 5 minutes after startup.

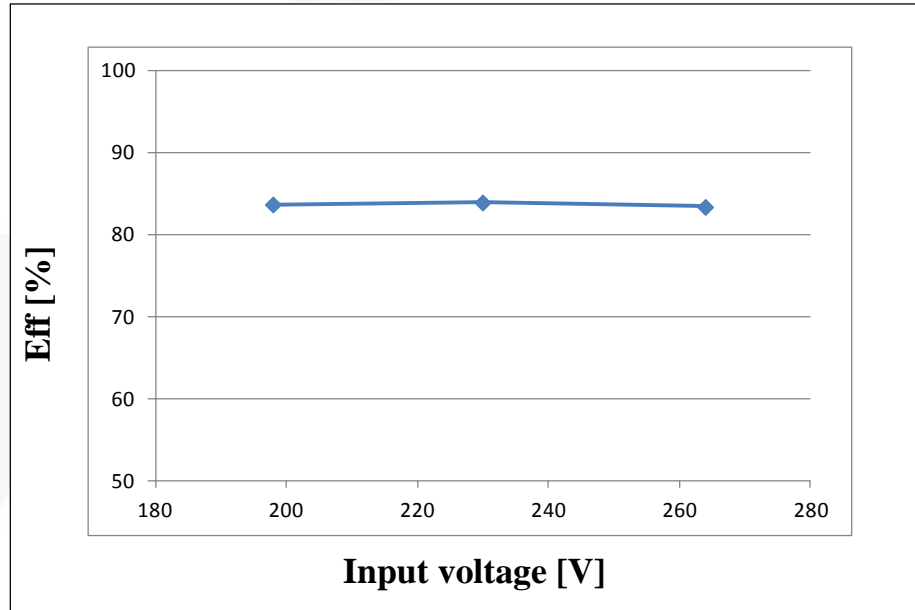

Figure 18. System Efficiency

Table 7. System Efficiency

Input Voltage	Input Power	Output Current	Output Voltage	Output Power	Efficiency
198 V _{AC} [60 Hz]	10.32 W	0.360 A	24 V	8.640 W	83.70%
230 V _{AC} [60 Hz]	10.26 W	0.359 A	24 V	8.616 W	83.94%
264 V _{AC} [60 Hz]	10.33 W	0.359 A	24 V	8.616 W	83.40%

8.7. Power Factor (PF) & Total Harmonic Distortion (THD)

The FL7734MX evaluation board shows excellent THD performance, less than 13%. Power factor has enough margins from 0.9. The results were measured using actual, rated LED loads 5 minutes after startup.

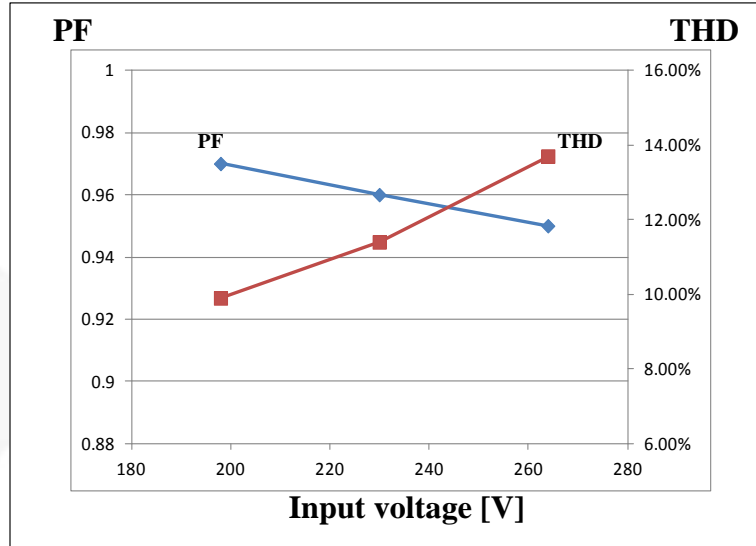

Figure 19. Power Factor & Total Harmonic Distortion

Table 8. Power Factor & Total Harmonic Distortion

Input Voltage	Output Current	Output Voltage	Power Factor	THD
198 V _{AC} [60 Hz]	0.360 A	24 V	0.97	9.9%
230 V _{AC} [60 Hz]	0.359 A	24 V	0.96	11.4%
264 V _{AC} [60 Hz]	0.359 A	24 V	0.95	13.7%

8.8. Dimming Operation

Figure 20 to Figure 22 shows the overall startup performance with dimmer connected at the rated output load. The output load current starts flowing 0.36 s after the AC input power switch turns on at small dimmer phase angle for input voltage 230 V_{AC} condition. CH1: V_{IN} (100 V / div), CH2: V_{DD} (10 V / div), CH4: I_{LED} (100 mA / div), Time Scale: (100 ms / div), Load: 8 series-connected LEDs.

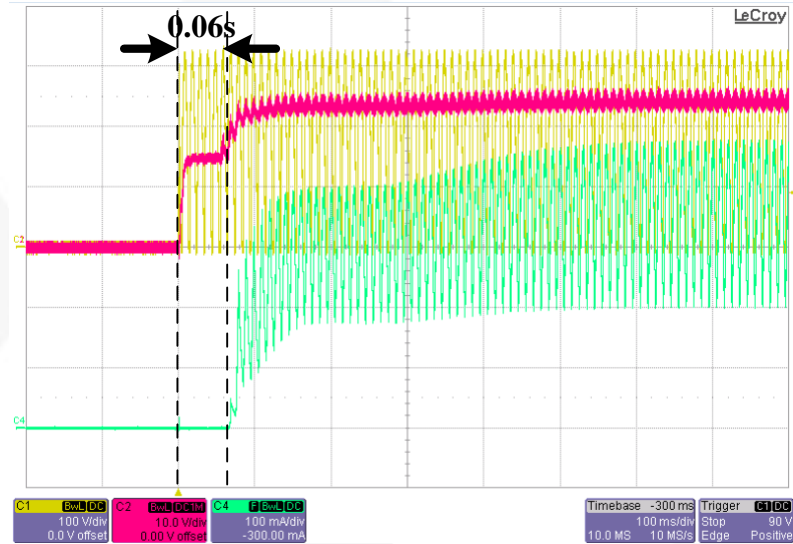

Figure 20. Max Phase Angle Dimming

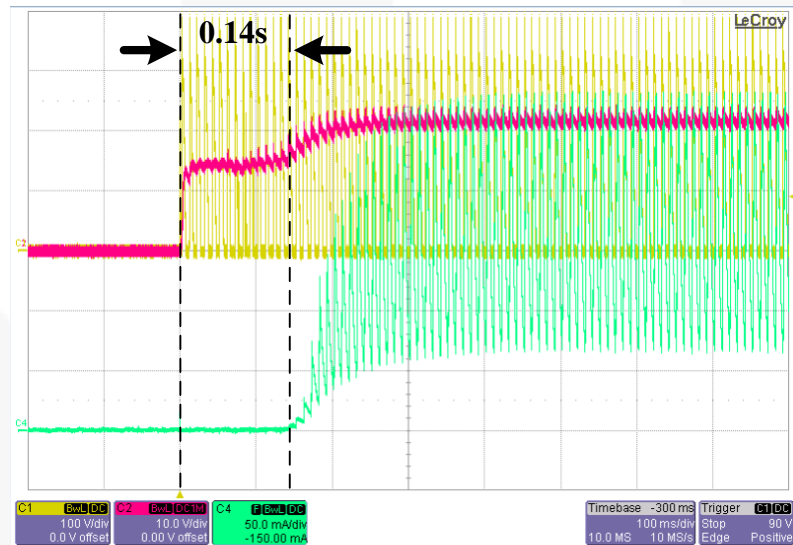

Figure 21. Half Phase Angle Dimming

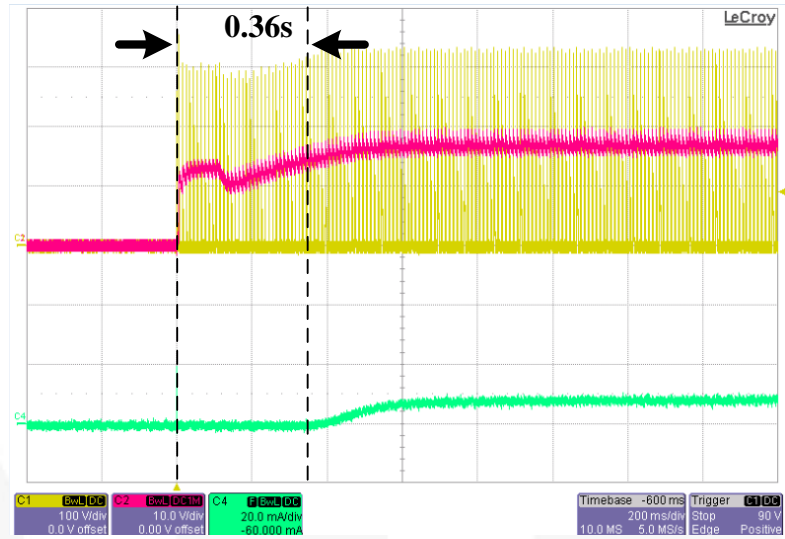

Figure 22. Min Phase Angle Dimming

Figure 23 demonstrates the dimming operation with a dimmer connected at the rated output load. Active DIM Control in FL7734MX provides stable dimmer operation and implements flicker-free dimming operation. CH1: V_{IN} (100 V / div), CH2: CS (500 mV / div), CH4: I_{LED} (100 mA / div), Time Scale: (100 ms / div), Load: 8 series-LEDs.

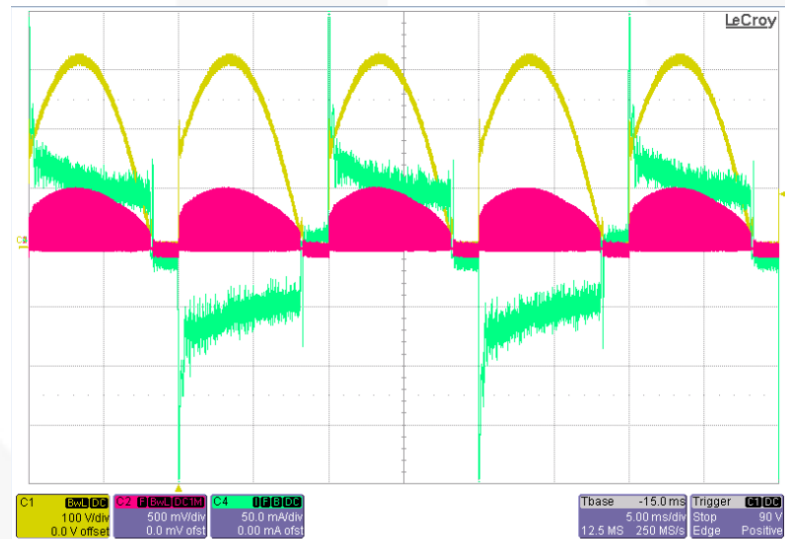

Figure 23. Max. Phase Angle Dimming

Figure 24 shows a dimming curve which is obtained by rotating the dimmer switch. Regardless of input line voltage $\pm 10\%$ variation, LED current is constantly regulated from 180 to 130° dimmer phase angle. When the phase angle is below 130°, LED current decreases linearly according to internal dimming reference modulation.

FL7734MX dimming control method can meet NEMA SSL-7A specification. Figure 25 indicates the maximum and minimum dimmed output range as specified by NEMA SSL-7A.

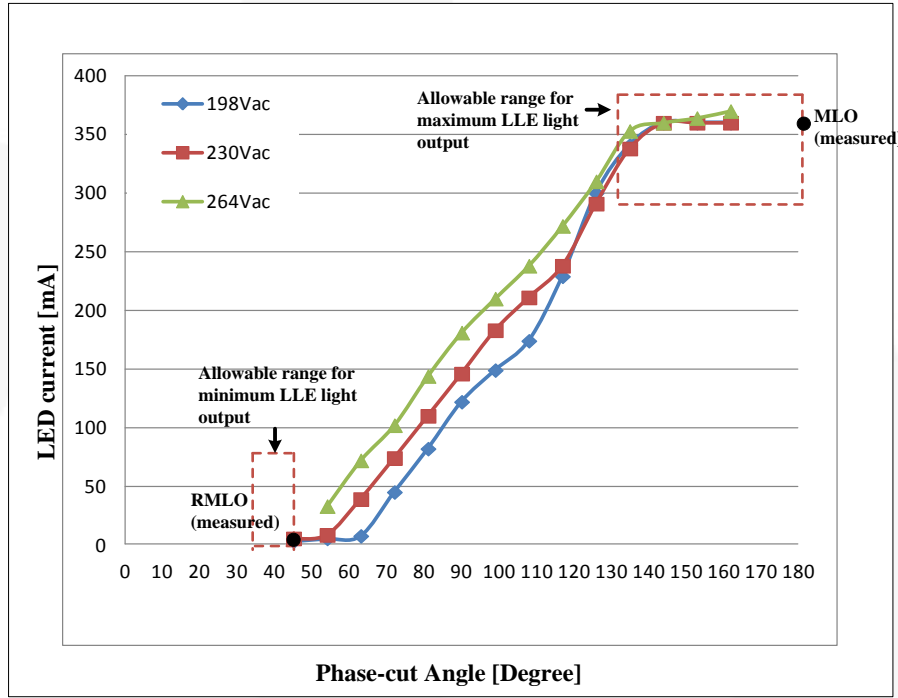

Figure 24. Dimming Curve

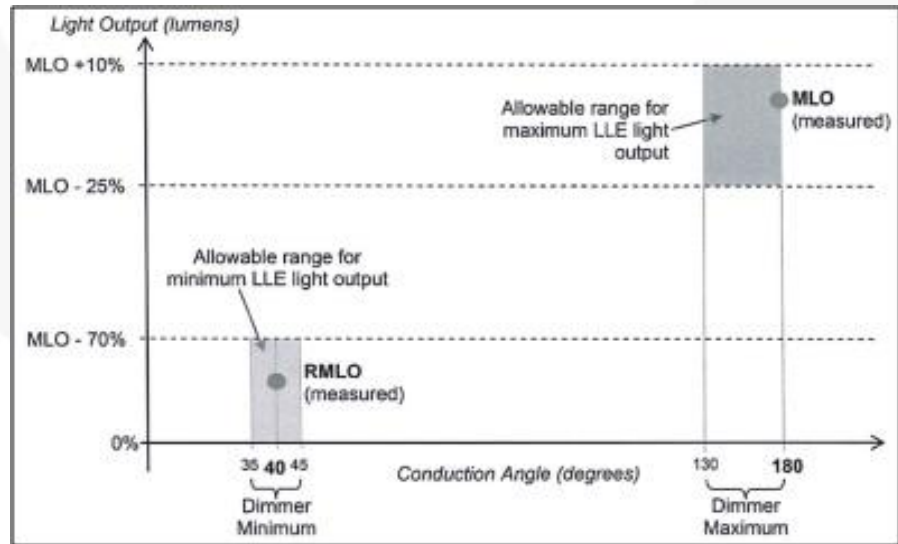

Figure 25. NEMA SSL-7A Specification



Table 9 demonstrates that FL7734MX evaluation board has excellent dimmer compatibility without flicker and the minimum output current can be less than 5% of the rated output current when evaluated with most dimmer. It also operates well with both forward phase dimmer and reverse phase dimmer.

Table 9. Dimmer compatibility

Manufacturer	Dimmer S/N	Condition	Max. Current [mA]	Min. Current [mA]	Flicker
BUSCH	2247U	230 V/50 Hz	361	11	NO
BUSCH	2250	230 V/50 Hz	361	8.3	NO
BUSCH	2200	230 V/50 Hz	360	13.6	NO
GIRA	226200	230 V/50 Hz	359	7	NO
JUNG	225NVDE	230 V/50 Hz	361	7.5	NO
JUNG	ST550	230 V/50 Hz	361	0	NO
JUNG	266GDE	230 V/50 Hz	360	9.7	NO
JUNG	244EX	230 V/50 Hz	363	6.5	NO
PEHA	436	230 V/50 Hz	362	10	NO
GIRA	2608	230 V/50 Hz	360	10	NO
Vossloh-Schwabe	172774	230 V/50 Hz	360	7.6	NO
KOPP	8033	230 V/50 Hz	360	11.8	NO
MERTEN	572199	230 V/50 Hz	359	4	NO
JIN HEUNG	SA04003	220 V/60 Hz	361	8.7	NO
JIN HEUNG	SA04003-3004	220 V/60 Hz	361	4	NO
NANO	SKD-500	220 V/60 Hz	360	4.5	NO
Legrand	0 488 69	100-240/50-60 Hz	355	3.1	NO
DAESUNG	SKD-500	220 V/60 Hz	359	2.3	NO
CLIPSAL	32E450TM	230 V/50 Hz	361	43	NO
MERTEN	577129	230 V/50 Hz	359	50	NO
EVERFLORISH	EF700DC	230 V/50 Hz	359	46	NO
GIRA	4210	230 V/50 Hz	360	46	NO

8.9. Operating Temperature

Temperatures on all components on this board are less than 72°C. The results were measured using the rated LED loads after 60 minutes burn-in.

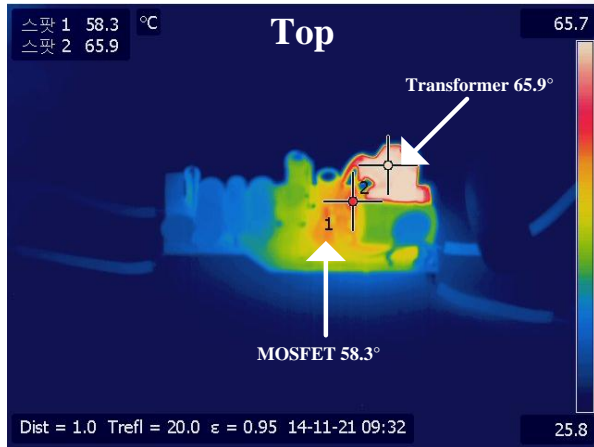

Figure 26. Non-Dimming Mode $V_{IN}=230 V_{AC}$

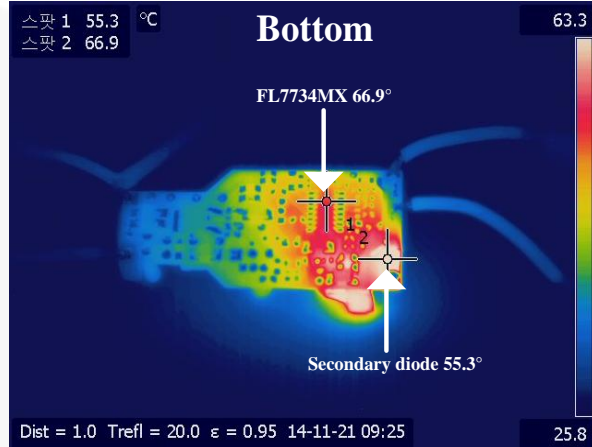

Figure 27. Non-Dimming Mode $V_{IN}=230 V_{AC}$

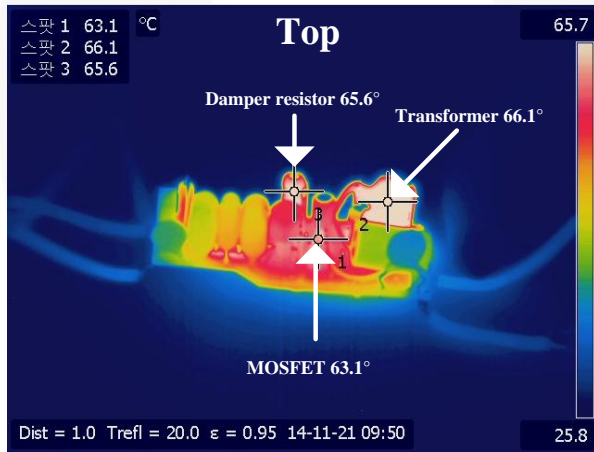

Figure 28. Dimming Mode $V_{IN}=230 V_{AC}$

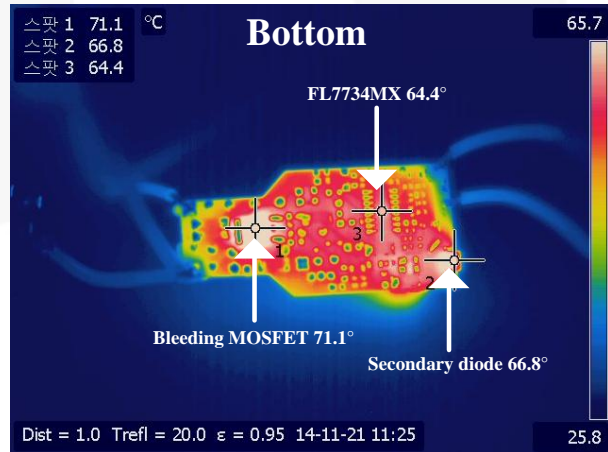

Figure 29. Dimming Mode $V_{IN}=230 V_{AC}$

8.10. Electromagnetic Interference (EMI)

All measurements were conducted in observance of EN55022 criteria. The results were measured using rated LED loads after 60 minutes burn-in.

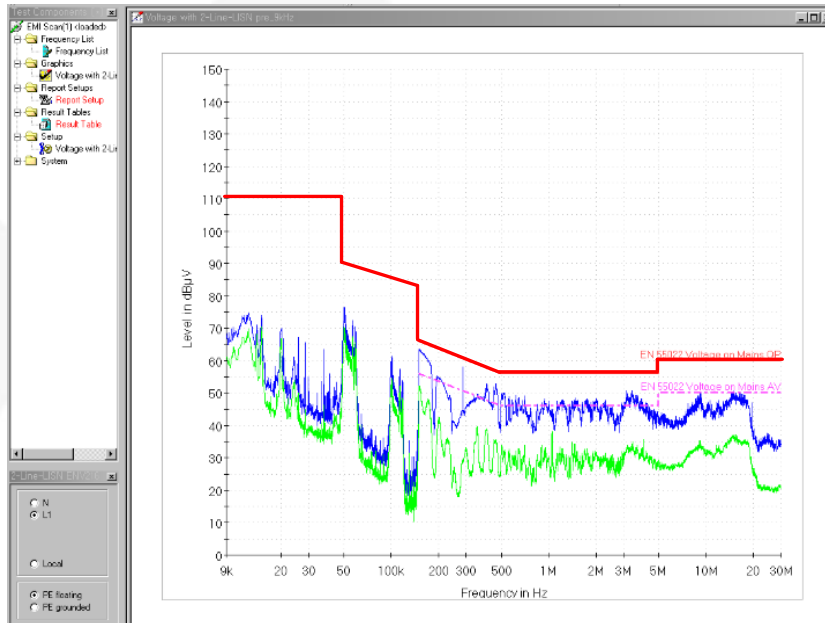

Figure 30. V_{IN} [230V_{AC}, Live]

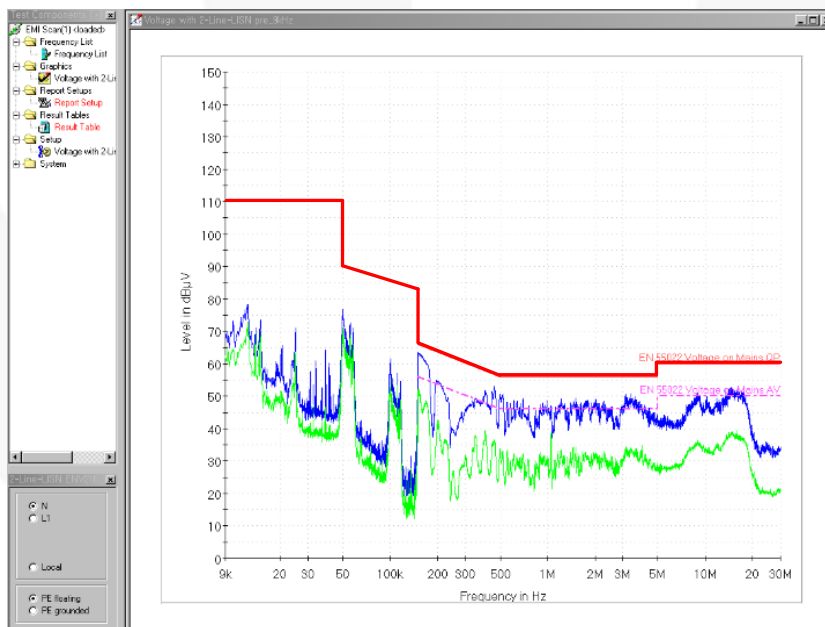

Figure 31. V_{IN} [230 V_{AC}, Neutral]



9. Revision History

Rev.	Date	Description
1.0.0	Feb. 2015	Initial Release

WARNING AND DISCLAIMER

Replace components on the Evaluation Board only with those parts shown on the parts list (or Bill of Materials) in the Users' Guide. Contact an authorized Fairchild representative with any questions.

The Evaluation board (or kit) is for demonstration purposes only and neither the Board nor this User's Guide constitute a sales contract or create any kind of warranty, whether express or implied, as to the applications or products involved. Fairchild warrants that its products meet Fairchild's published specifications, but does not guarantee that its products work in any specific application. Fairchild reserves the right to make changes without notice to any products described herein to improve reliability, function, or design. Either the applicable sales contract signed by Fairchild and Buyer or, if no contract exists, Fairchild's standard Terms and Conditions on the back of Fairchild invoices, govern the terms of sale of the products described herein.

DISCLAIMER

FAIRCHILD SEMICONDUCTOR RESERVES THE RIGHT TO MAKE CHANGES WITHOUT FURTHER NOTICE TO ANY PRODUCTS HEREIN TO IMPROVE RELIABILITY, FUNCTION, OR DESIGN. FAIRCHILD DOES NOT ASSUME ANY LIABILITY ARISING OUT OF THE APPLICATION OR USE OF ANY PRODUCT OR CIRCUIT DESCRIBED HEREIN; NEITHER DOES IT CONVEY ANY LICENSE UNDER ITS PATENT RIGHTS, NOR THE RIGHTS OF OTHERS.

LIFE SUPPORT POLICY

FAIRCHILD'S PRODUCTS ARE NOT AUTHORIZED FOR USE AS CRITICAL COMPONENTS IN LIFE SUPPORT DEVICES OR SYSTEMS WITHOUT THE EXPRESS WRITTEN APPROVAL OF THE PRESIDENT OF FAIRCHILD SEMICONDUCTOR CORPORATION.

As used herein:

1. Life support devices or systems are devices or systems which, (a) are intended for surgical implant into the body, or (b) support or sustain life, or (c) whose failure to perform when properly used in accordance with instructions for use provided in the labeling, can be reasonably expected to result in significant injury to the user.
2. A critical component is any component of a life support device or system whose failure to perform can be reasonably expected to cause the failure of the life support device or system, or to affect its safety or effectiveness.

ANTI-COUNTERFEITING POLICY

Fairchild Semiconductor Corporation's Anti-Counterfeiting Policy. Fairchild's Anti-Counterfeiting Policy is also stated on our external website, www.fairchildsemi.com, under Sales Support.

Counterfeiting of semiconductor parts is a growing problem in the industry. All manufacturers of semiconductor products are experiencing counterfeiting of their parts. Customers who inadvertently purchase counterfeit parts experience many problems such as loss of brand reputation, substandard performance, failed applications, and increased cost of production and manufacturing delays. Fairchild is taking strong measures to protect ourselves and our customers from the proliferation of counterfeit parts. Fairchild strongly encourages customers to purchase Fairchild parts either directly from Fairchild or from Authorized Fairchild Distributors who are listed by country on our web page cited above. Products customers buy either from Fairchild directly or from Authorized Fairchild Distributors are genuine parts, have full traceability, meet Fairchild's quality standards for handling and storage and provide access to Fairchild's full range of up-to-date technical and product information. Fairchild and our Authorized Distributors will stand behind all warranties and will appropriately address any warranty issues that may arise. Fairchild will not provide any warranty coverage or other assistance for parts bought from Unauthorized Sources. Fairchild is committed to combat this global problem and encourage our customers to do their part in stopping this practice by buying direct or from authorized distributors.

Mouser Electronics

Authorized Distributor

Click to View Pricing, Inventory, Delivery & Lifecycle Information:

[Fairchild Semiconductor:](#)

[FEBFL7734_L55H008A](#)

Компания «Океан Электроники» предлагает заключение долгосрочных отношений при поставках импортных электронных компонентов на взаимовыгодных условиях!

Наши преимущества:

- Поставка оригинальных импортных электронных компонентов напрямую с производств Америки, Европы и Азии, а так же с крупнейших складов мира;
- Широкая линейка поставок активных и пассивных импортных электронных компонентов (более 30 млн. наименований);
- Поставка сложных, дефицитных, либо снятых с производства позиций;
- Оперативные сроки поставки под заказ (от 5 рабочих дней);
- Экспресс доставка в любую точку России;
- Помощь Конструкторского Отдела и консультации квалифицированных инженеров;
- Техническая поддержка проекта, помощь в подборе аналогов, поставка прототипов;
- Поставка электронных компонентов под контролем ВП;
- Система менеджмента качества сертифицирована по Международному стандарту ISO 9001;
- При необходимости вся продукция военного и аэрокосмического назначения проходит испытания и сертификацию в лаборатории (по согласованию с заказчиком);
- Поставка специализированных компонентов военного и аэрокосмического уровня качества (Xilinx, Altera, Analog Devices, Intersil, Interpoint, Microsemi, Actel, Aeroflex, Peregrine, VPT, Syfer, Eurofarad, Texas Instruments, MS Kennedy, Miteq, Cobham, E2V, MA-COM, Hittite, Mini-Circuits, General Dynamics и др.);

Компания «Океан Электроники» является официальным дистрибьютором и эксклюзивным представителем в России одного из крупнейших производителей разъемов военного и аэрокосмического назначения «JONHON», а так же официальным дистрибьютором и эксклюзивным представителем в России производителя высокотехнологичных и надежных решений для передачи СВЧ сигналов «FORSTAR».



JONHON

«JONHON» (основан в 1970 г.)

Разъемы специального, военного и аэрокосмического назначения:

(Применяются в военной, авиационной, аэрокосмической, морской, железнодорожной, горно- и нефтедобывающей отраслях промышленности)

«FORSTAR» (основан в 1998 г.)

ВЧ соединители, коаксиальные кабели,
кабельные сборки и микроволновые компоненты:

(Применяются в телекоммуникациях гражданского и специального назначения, в средствах связи, РЛС, а так же военной, авиационной и аэрокосмической отраслях промышленности).



Телефон: 8 (812) 309-75-97 (многоканальный)

Факс: 8 (812) 320-03-32

Электронная почта: ocean@oceanchips.ru

Web: <http://oceanchips.ru/>

Адрес: 198099, г. Санкт-Петербург, ул. Калинина, д. 2, корп. 4, лит. А