

# D2AW

Sealed Ultra Subminiature Basic Switch

## Long stroke seal switch with high reliability and high insulation performance

- <Clipping contact> Double reliability by twin contacts (=Clipping contact). Foreign materials are cleaned out by the sliding contacts.
- <Quiet operation> Quiet operating sound by sliding contact construction is needed for high grade car.
- <High insulation performance> High performance of Insulation resistance by unique contact structure.

RoHS Compliant



## Model Number Legend

D2AW-□□□□□□

1 2 3 4 5 6

### 1. Mounting Structure

- A: Without posts
- ER: With posts on right
- EL: With posts on left

### 2. Ratings

- 0: 0.1 A at 12 VDC

### 3. Actuator

- 0: Pin plunger
- 5: Long straight leaf lever
- 6: Leaf lever
- 7: Simulated roller leaf lever
- 8: Long leaf lever

### 4. Contact Form

- 2: SPST-NC
- 3: SPST-NO

### 5. Terminals

- D: Straight PCB terminals
- H: Solder terminals

### 6. Option Code

- Customized Code

### List of Models

Due to the idiosyncrasies of the automotive parts industry, a business decision is required on individual items to determine when to start supply. Contact your OMRON representative for information on individual models.

Actuator	Terminals	Model	Without posts	With posts on right	With posts on left
		Contact Form			
<b>Pin plunger</b> 	Solder terminals	SPST-NC	D2AW-A002H	D2AW-ER002H	D2AW-EL002H
		SPST-NO	D2AW-A003H	D2AW-ER003H	D2AW-EL003H
	PCB terminals	SPST-NC	D2AW-A002D	D2AW-ER002D	D2AW-EL002D
		SPST-NO	D2AW-A003D	D2AW-ER003D	D2AW-EL003D
<b>Long straight leaf lever</b> 	Solder terminals	SPST-NC	D2AW-A052H	D2AW-ER052H	D2AW-EL052H
		SPST-NO	D2AW-A053H	D2AW-ER053H	D2AW-EL053H
	PCB terminals	SPST-NC	D2AW-A052D	D2AW-ER052D	D2AW-EL052D
		SPST-NO	D2AW-A053D	D2AW-ER053D	D2AW-EL053D
<b>Leaf lever</b> 	Solder terminals	SPST-NC	D2AW-A062H	D2AW-ER062H	D2AW-EL062H
		SPST-NO	D2AW-A063H	D2AW-ER063H	D2AW-EL063H
	PCB terminals	SPST-NC	D2AW-A062D	D2AW-ER062D	D2AW-EL062D
		SPST-NO	D2AW-A063D	D2AW-ER063D	D2AW-EL063D
<b>Simulated roller leaf lever</b> 	Solder terminals	SPST-NC	D2AW-A072H	D2AW-ER072H	D2AW-EL072H
		SPST-NO	D2AW-A073H	D2AW-ER073H	D2AW-EL073H
	PCB terminals	SPST-NC	D2AW-A072D	D2AW-ER072D	D2AW-EL072D
		SPST-NO	D2AW-A073D	D2AW-ER073D	D2AW-EL073D
<b>Long leaf lever</b> 	Solder terminals	SPST-NC	D2AW-A082H	D2AW-ER082H	D2AW-EL082H
		SPST-NO	D2AW-A083H	D2AW-ER083H	D2AW-EL083H
	PCB terminals	SPST-NC	D2AW-A082D	D2AW-ER082D	D2AW-EL082D
		SPST-NO	D2AW-A083D	D2AW-ER083D	D2AW-EL083D

### Contact Specifications

Contact	Specification	Slide
	Material	Sliver Plated
Minimum applicable load ( see note )		5 VDC 1 mA

**Note:** For more information on the minimum applicable load, refer to *Using Micro Loads*.

### Ratings

Rating voltage	Resistive load
12 VDC	0.1 A

**Note:** The rating values apply under the following test conditions.

1. Ambient temperature:  $20 \pm 2^\circ\text{C}$
2. Ambient humidity:  $65 \pm 5\%$
3. Operating frequency: 20 operations/min

## Characteristics

<b>Permissible operating speed</b>		30 mm to 500 mm/s (pin plunger models)
<b>Permissible operating frequency</b>	<b>Mechanical</b>	30 operations/min max.
	<b>Electrical</b>	20 operations/min max.
<b>Insulation resistance</b>		100 MΩ min. (at 500 VDC)
<b>Contact resistance (initial value)</b>		100 mΩ max.
<b>Dielectric strength *1</b>	<b>Between terminals of the same polarity</b>	600 VAC 50/60 Hz 1min
	<b>Between current-carrying metal parts and ground</b>	1,500 VAC 50/60 Hz 1min
	<b>Between terminals and non-current-carrying metal parts</b>	1,500 VAC 50/60 Hz 1min
<b>Vibration resistance</b>	<b>Malfunction</b>	10 to 55 Hz, 1.5 mm double amplitude
<b>Shock resistance</b>	<b>Destruction</b>	1,000 m/s <sup>2</sup> max.
	<b>Malfunction</b>	300 m/s <sup>2</sup> max.
<b>Durability *2</b>	<b>Mechanical</b>	200,000 operations min. (30 operations/min)
	<b>Electrical</b>	200,000 operations min. (20 operations/min)
<b>Degree of protection</b>		IEC IP67
<b>Ambient operating temperature</b>		-40 to 85°C (at 60%RH max.) (with no icing or condensation)
<b>Ambient operation humidity</b>		95%RH max. (for +5 to +35°C)
<b>Weight</b>		Approx. 0.7 g (for pin plunger models with terminals)

Note: The data given above are initial values.

\*1. The values for dielectric strength shown are for models with a Separator.  
Refer to your OMRON website.

\*2. For testing conditions, consult your OMRON sales representative.

## Mounting Structure and Reference Positions for Operating Characteristics (Unit: mm)

### ● Without posts

D2AW-A□

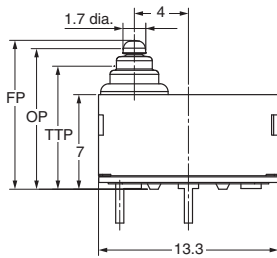

### ● Models with Posts

D2AW-E□

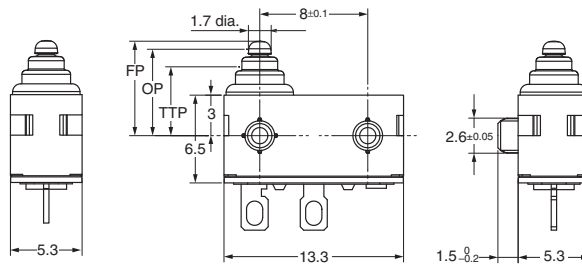

### Mounting Hole Dimensions (Reference)

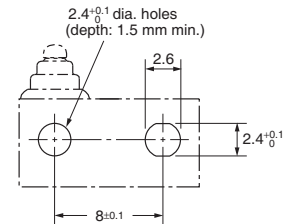

## Terminals (Unit: mm)

### ● PCB terminals

SPST-NO



SPST-NC



### <PCB Mounting Dimensions (Reference)>

SPST-NO

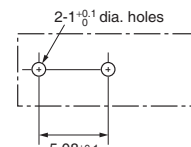

SPST-NC

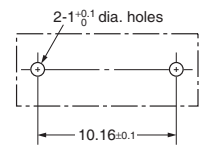

### ● Solder terminals

SPST-NO

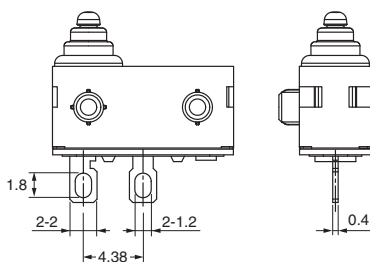

SPST-NC

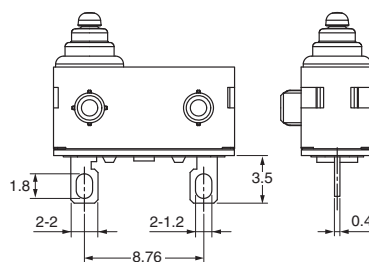

## Dimensions (Unit: mm) / Operating Characteristics

The following illustrations and drawings are for solder terminal models. PCB terminal models are omitted from the drawings. Refer to *Terminals* for these terminals. When ordering, replace □ with the code for the rating that you need. For the combination of models, refer to *List of Models*.

### ● Pin plunger

D2AW-□00□□



Operating characteristics	Type	Without posts	Models with Posts
Operating Force	OF Max.	1.00N {101 gf}	
Releasing Force	RF Min.	0.10N {10 gf}	
Overtravel	OT	1.4 mm (reference value)	
Movement Differential	MD Max.	0.25 mm	
Free Position	FP Max.	11.2 mm	7.2 mm
Operating Position	OP	10.4 ± 0.3 mm	6.4 ± 0.3 mm
Total Travel Position	TTP	9.1 mm	5.1 mm

### ● Long straight leaf lever

D2AW-□05□□

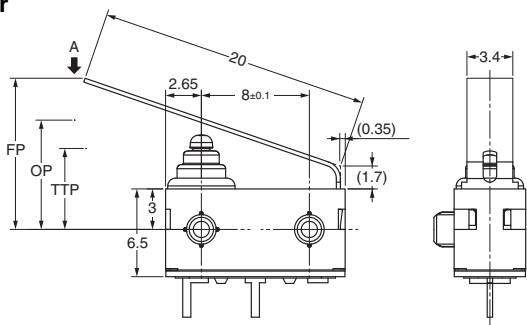

Operating characteristics	Type	Without posts	Models with Posts
Operating Force	OF Max.	1.50N {152 gf}	
Releasing Force	RF Min.	0.10N {10 gf}	
Overtravel	OT	2.5 mm (reference value)	
Movement Differential	MD Max.	0.7 mm	
Free Position	FP Max.	15.9 mm	11.9 mm
Operating Position	OP	12.1 ± 0.8 mm	8.1 ± 0.8 mm
Total Travel Position	TTP	10.0 mm	6.0 mm

### ● Leaf lever

D2AW-□06□□



Operating characteristics	Type	Without posts	Models with Posts
Operating Force	OF Max.	2.00N {203 gf}	
Releasing Force	RF Min.	0.20N {20 gf}	
Overtravel	OT	1.8 mm (reference value)	
Movement Differential	MD Max.	0.5 mm	
Free Position	FP Max.	13.3 mm	9.3 mm
Operating Position	OP	11.4 ± 0.5 mm	7.4 ± 0.5 mm
Total Travel Position	TTP	9.8 mm	5.8 mm

### ● Simulated roller leaf lever

D2AW-□07□□



Operating characteristics	Type	Without posts	Models with Posts
Operating Force	OF Max.	1.80N {183gf}	
Releasing Force	RF Min.	0.20N {20 gf}	
Overtravel	OT	2.0 mm (reference value)	
Movement Differential	MD Max.	0.5 mm	
Free Position	FP Max.	17.0 mm	13.0 mm
Operating Position	OP	14.8 ± 0.5 mm	10.8 ± 0.5 mm
Total Travel Position	TTP	12.9 mm	8.9 mm

### ● Long leaf lever

D2AW-□08□□



Operating characteristics	Type	Without posts	Models with Posts
Operating Force	OF Max.	0.90N {91 gf}	
Releasing Force	RF Min.	0.05N {5 gf}	
Overtravel	OT	2.8 mm (reference value)	
Movement Differential	MD Max.	0.7 mm	
Free Position	FP Max.	23.0 mm	19.0 mm
Operating Position	OP	19.4 ± 1.5 mm	15.4 ± 1.5 mm
Total Travel Position	TTP	16.8 mm	12.8 mm

Note1. Unless otherwise specified, a tolerance of ±0.2 mm applies to all dimensions.

Note2. The operating characteristics are for operation in the A direction (↓).

## Precautions

Please refer to "Safety Precautions for All Detection Switches" for correct use.

### Cautions

#### ●Degree of Protection

- Do not use this product underwater.  
Although molded lead wire models satisfy the test conditions for the standard given below, this test is to check the ingress of water into the switch enclosure after submerging the Switch in water for a given time. Satisfying this test condition does not mean that the Switch can be used underwater.

JIS C0920:

Degrees of protection provided by enclosures of electrical apparatus (IP Code)

IEC 60529:

Degrees of protection provided by enclosures (IP Code)

Degree of protection: IP67

(check water intrusion after immersion for 30 min. submerged 1m underwater)

- Do not operate the Switch when it is exposed to water spray, or when water drops adhere to the Switch surface, or during sudden temperature changes, otherwise water may intrude into the interior of the Switch due to a suction effect.
- Prevent the Switch from coming into contact with oil and chemicals.  
Otherwise, damage to or deterioration of Switch materials may result.
- Do not use the Switch in areas where it is exposed to silicon adhesives, oil, or grease. Otherwise faulty contact may result due to the generation of silicon oxide.

#### ●Soldering

When soldering the lead wire to the terminal, first insert the lead wire conductor through the terminal hole and then conduct soldering.

Make sure that the temperature of the soldering iron tip does not exceed 300°C, and complete the soldering within 3 seconds. Do not apply any external force for 1 minute after soldering.

Soldering at an excessively high temperature or soldering for more than 3 seconds may deteriorate the characteristics of the Switch.

In case of automatic soldering, please do not apply the heat beyond 260°C within 5 seconds. Pay careful attention so that flux or solder liquid does not flow over the edge of the PCB panel.

#### ●Side-actuated (Cam/Dog) Operation

- When using a cam or dog to operate the Switch, factors such as the operating speed, operating frequency, push-button indentation, and material and shape of the cam or dog will affect the durability of the Switch. Confirm performance specifications under actual operating conditions before using the Switch in applications.

### Correct Use

#### ●Mounting

- Turn OFF the power supply before mounting or removing the Switch, wiring, or performing maintenance or inspection. Failure to do so may result in electric shock or burning.
- For models with posts, secure the posts by thermal caulking or by pressing into an attached device. When pressed into an attached device, provide guides on the opposite ends of the posts to ensure that they do not fall out or rattle. Thermal caulking conditions varies according to the equipment, jig and base used for switch mounting. Consult your OMRON sales representative for details.

#### ●Operating Body

- Use an operating body with low frictional resistance and of a shape that will not interfere with the sealing rubber, otherwise the plunger may be damaged or the sealing may deteriorate.

#### ●Handling

- Do not handle the Switch in a way that may cause damage to the sealing rubber.
- When handling the Switch, ensure that pressure is not applied to the posts in the directions shown in the following diagram. Also, ensure that uneven pressure or pressure in a direction other than the operating direction is not applied to the Actuator as shown in the following diagram. Otherwise, the post, Actuator, or Switch may be damaged, or the service life may be reduced.



#### ●Using Micro Loads

- Even when using micro load models within the operating range shown below, if inrush/surge current occurs, it may increase the contact wear and so decrease durability. Therefore, insert a contact protection circuit where necessary.

- Application examples provided in this document are for reference only. In actual applications, confirm equipment functions and safety before using the product.
- Consult your OMRON representative before using the product under conditions which are not described in the manual or applying the product to nuclear control systems, railroad systems, aviation systems, vehicles, combustion systems, medical equipment, amusement machines, safety equipment, and other systems or equipment that may have a serious influence on lives and property if used improperly. Make sure that the ratings and performance characteristics of the product provide a margin of safety for the system or equipment, and be sure to provide the system or equipment with double safety mechanisms.

**Note: Do not use this document to operate the Unit.**

Компания «Океан Электроники» предлагает заключение долгосрочных отношений при поставках импортных электронных компонентов на взаимовыгодных условиях!

Наши преимущества:

- Поставка оригинальных импортных электронных компонентов напрямую с производств Америки, Европы и Азии, а так же с крупнейших складов мира;
- Широкая линейка поставок активных и пассивных импортных электронных компонентов (более 30 млн. наименований);
- Поставка сложных, дефицитных, либо снятых с производства позиций;
- Оперативные сроки поставки под заказ (от 5 рабочих дней);
- Экспресс доставка в любую точку России;
- Помощь Конструкторского Отдела и консультации квалифицированных инженеров;
- Техническая поддержка проекта, помощь в подборе аналогов, поставка прототипов;
- Поставка электронных компонентов под контролем ВП;
- Система менеджмента качества сертифицирована по Международному стандарту ISO 9001;
- При необходимости вся продукция военного и аэрокосмического назначения проходит испытания и сертификацию в лаборатории (по согласованию с заказчиком);
- Поставка специализированных компонентов военного и аэрокосмического уровня качества (Xilinx, Altera, Analog Devices, Intersil, Interpoint, Microsemi, Actel, Aeroflex, Peregrine, VPT, Syfer, Eurofarad, Texas Instruments, MS Kennedy, Miteq, Cobham, E2V, MA-COM, Hittite, Mini-Circuits, General Dynamics и др.);

Компания «Океан Электроники» является официальным дистрибьютором и эксклюзивным представителем в России одного из крупнейших производителей разъемов военного и аэрокосмического назначения «JONHON», а так же официальным дистрибьютором и эксклюзивным представителем в России производителя высокотехнологичных и надежных решений для передачи СВЧ сигналов «FORSTAR».



## JONHON

«JONHON» (основан в 1970 г.)

Разъемы специального, военного и аэрокосмического назначения:

(Применяются в военной, авиационной, аэрокосмической, морской, железнодорожной, горно- и нефтедобывающей отраслях промышленности)

«FORSTAR» (основан в 1998 г.)

ВЧ соединители, коаксиальные кабели, кабельные сборки и микроволновые компоненты:

(Применяются в телекоммуникациях гражданского и специального назначения, в средствах связи, РЛС, а так же военной, авиационной и аэрокосмической отраслях промышленности).



Телефон: 8 (812) 309-75-97 (многоканальный)

Факс: 8 (812) 320-03-32

Электронная почта: [ocean@oceanchips.ru](mailto:ocean@oceanchips.ru)

Web: <http://oceanchips.ru/>

Адрес: 198099, г. Санкт-Петербург, ул. Калинина, д. 2, корп. 4, лит. А