



# 500 MHz Dual Integrated DCL with Differential Drive/Receive, Level Setting DACs, and Per Pin PMU

## ADATE302-02

### FEATURES

#### Driver

- 3-level driver with high-Z mode and built-in clamps
- Precision trimmed output resistance
- Low leakage mode (typically <math><10\text{ nA}</math>)
- Voltage range:  $-2.0\text{ V}$  to  $+6.0\text{ V}$
- 1.0 ns minimum pulse width, 1 V terminated

#### Comparator

- Window and differential comparator
- >1 GHz input equivalent bandwidth

#### Load

- $\pm 12\text{ mA}$  maximum current capability

#### Per pin PMU

- Force voltage range:  $-2.0\text{ V}$  to  $+6.0\text{ V}$
- 5 current ranges: 25 mA, 2 mA, 200  $\mu\text{A}$ , 20  $\mu\text{A}$ , and 2  $\mu\text{A}$

#### Levels

- 14-bit DAC for DCL levels
- Typically  $<\pm 5\text{ mV INL}$  (calibrated)
- 16-bit DAC for PMU levels
- Typically  $<\pm 1.5\text{ mV INL}$  (calibrated) linearity in FV mode

#### HVOUT output buffer

- 0 V to 13.5 V output range

#### Packages

- 84-ball, 9 mm  $\times$  9 mm, flip-chip BGA
- 100-lead TQFP\_EP
- 1.7 W per channel with no load

### APPLICATIONS

- Automatic test equipment
- Semiconductor test systems
- Board test systems
- Instrumentation and characterization equipment

### GENERAL DESCRIPTION

The ADATE302-02 is a complete, single-chip solution that performs the pin electronic functions of the driver, the comparator, and the active load (DCL), per pin PMU, and dc levels for ATE applications. The device also contains an HVOUT driver with a VHH buffer capable of generating up to 13.5 V.

The driver features three active states: data high mode, data low mode, and term mode, as well as an inhibit state. The inhibit state, in conjunction with the integrated dynamic clamp, facilitates the implementation of a high speed active termination. The output voltage range is  $-2.0\text{ V}$  to  $+6.0\text{ V}$  to accommodate a wide variety of test devices.

The ADATE302-02 can be used as either a dual single-ended drive/receive channel or a single differential drive/receive channel. Each channel of the ADATE302-02 features a high speed window comparator for functional testing as well as a per pin PMU with FV or FI and MV or MI functions. All necessary dc levels for DCL functions are generated by on-chip 14-bit DACs. The per pin PMU features an on-chip 16-bit DAC for high accuracy and contains integrated range resistors to minimize external component counts.

The ADATE302-02 uses a serial bus to program all functional blocks and has an on-board temperature sensor for monitoring the device temperature.

#### Rev. A

Information furnished by Analog Devices is believed to be accurate and reliable. However, no responsibility is assumed by Analog Devices for its use, nor for any infringements of patents or other rights of third parties that may result from its use. Specifications subject to change without notice. No license is granted by implication or otherwise under any patent or patent rights of Analog Devices. Trademarks and registered trademarks are the property of their respective owners.

## TABLE OF CONTENTS

|                                  |    |  |    |
|----------------------------------|----|--|----|
| Features .....                   | 1  | Absolute Maximum Ratings .....                   | 20 |
| Applications.....                | 1  | Thermal Resistance.....                          | 20 |
| General Description .....        | 1  | Explanation of Test Levels.....                  | 20 |
| Revision History .....           | 2  | ESD Caution.....                                 | 20 |
| Functional Block Diagram .....   | 3  | Pin Configuration and Function Descriptions..... | 21 |
| Specifications.....              | 4  | Typical Performance Characteristics .....        | 27 |
| Total Function.....              | 4  | Serial Peripheral Interface Details.....         | 39 |
| Driver .....                     | 5  | Definition of SPI Word.....                      | 40 |
| Reflection Clamp.....            | 7  | Write Operation.....                             | 41 |
| Normal Window Comparator .....   | 7  | Read Operation .....                             | 42 |
| Differential Comparator .....    | 9  | Reset Operation .....                            | 43 |
| Active Load.....                 | 11 | Register Map .....                               | 44 |
| PMU .....                        | 12 | Details of Registers .....                       | 45 |
| External Sense (PMUS_CHx).....   | 16 | User Information .....                           | 47 |
| DUTGND Input .....               | 17 | Details of DACs vs. Levels.....                  | 48 |
| Serial Peripheral Interface..... | 17 | Recommended PMU Mode Switching Sequences .....   | 50 |
| HVOUT Driver.....                | 17 | Block Diagrams.....                              | 53 |
| Overvoltage Detector (OVD) ..... | 18 | Outline Dimensions .....                         | 57 |
| 16-Bit DAC Monitor Mux.....      | 19 | Ordering Guide .....                             | 58 |

## REVISION HISTORY

### 4/09—Rev. 0 to Rev. A

|  |            |
|--|------------|
| Added 100-Lead TQFP_EP Package.....                  | Throughout |
| Added Figure 3, Renumbered Figures Sequentially..... | 22         |
| Added Table 17, Renumbered Tables Sequentially ..... | 22         |
| Updated Outline Dimensions .....                     | 52         |
| Changes to Ordering Guide .....                      | 53         |

### 6/08—Revision 0: Initial Version

# FUNCTIONAL BLOCK DIAGRAM

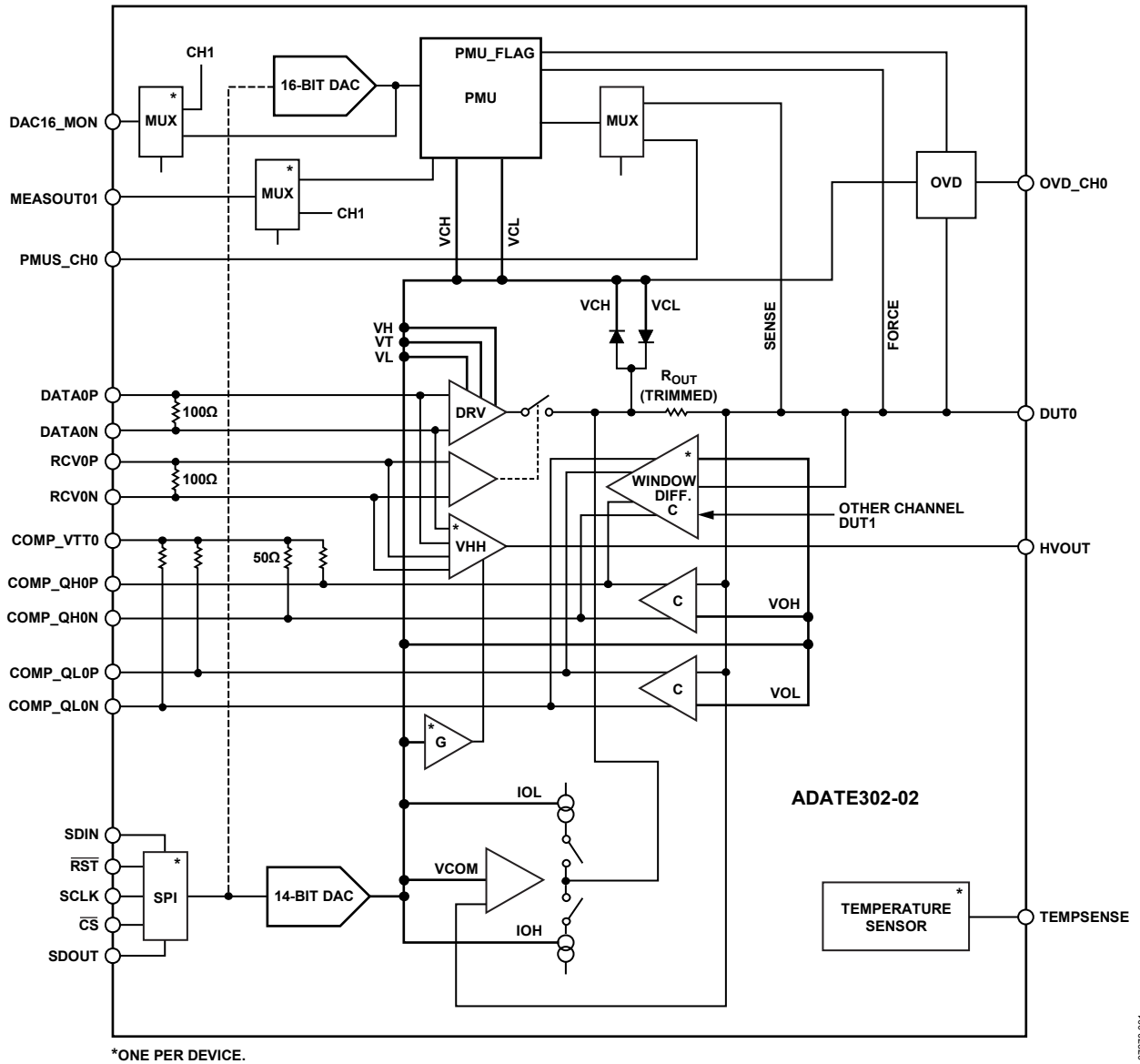

Figure 1. Functional Block Diagram with One of Two Channels Shown

100-96270

## SPECIFICATIONS

$V_{DD} = 10.0\text{ V}$ ,  $V_{CC} = 3.3\text{ V}$ ,  $V_{SS} = -5.75\text{ V}$ ,  $V_{PLUS} = 16.75\text{ V}$ ,  $V_{COMP\_VTTX} = 1.5\text{ V}$ ,  $V_{REF} = 5.0\text{ V}$ ,  $V_{REF\_GND} = 0.0\text{ V}$ . All default test conditions are as defined in Table 38. All specified values are at  $T_j = 80^\circ\text{C}$ , where  $T_j$  corresponds to the internal temperature sensor, unless otherwise noted. Temperature coefficients are measured at  $T_j = 80^\circ\text{C} \pm 20^\circ\text{C}$ , unless otherwise noted. Typical values are based on design, simulation analyses, and/or limited bench evaluations. Typical values are not tested or guaranteed. Test levels are specified in the Explanation of Test Levels section.

## TOTAL FUNCTION

Table 1.

| Parameter  | Min   | Typ   | Max   | Unit             | Test Level | Conditions/Comments  |
|--|-------|-------|-------|------------------|------------|--|
| <b>TOTAL FUNCTION</b>  |       |       |       |                  |            |  |
| Output Leakage Current   |       |       |       |                  |            |  |
| PE Disable, Range E  | -20.0 | +6.0  | +20.0 | nA               | P          | $-2.0\text{ V} < V_{DUTX} < +6.0\text{ V}$ ; PMU and PE disabled via SPI; $V_{CH} = 7.0\text{ V}$ , $V_{CL} = -2.5\text{ V}$                           |
| PE Disable, Range A, B, C, D   |       | 7.5   |       | nA               | $C_T$      | $-2.0\text{ V} < V_{DUTX} < +6.0\text{ V}$ ; PMU and PE disabled via SPI; $V_{CH} = 7.0\text{ V}$ , $V_{CL} = -2.5\text{ V}$                           |
| High-Z Mode  | -400  | +15   | +400  | nA               | P          | $-2.0\text{ V} < V_{DUTX} < +6.0\text{ V}$ ; PMU disabled and PE enabled via SPI; RCVx pins active, $V_{CH} = 7.0\text{ V}$ , $V_{CL} = -2.5\text{ V}$ |
| Output Capacitance   |       | 4     |       | pF               | S          | VTERM mode operation   |
| DUT Pin Range  | -2.0  |       | +6.0  | V                | D          |  |
| <b>POWER SUPPLIES</b>  |       |       |       |                  |            |  |
| Total Supply Range, $V_{PLUS}$ to $V_{SS}$   |       | 22.5  | 23.25 | V                | D          | Defines PSRR conditions  |
| $V_{PLUS}$ Supply, $V_{PLUS}$  | 16.25 | 16.75 | 17.25 | V                | D          | Defines PSRR conditions  |
| Positive Supply, $V_{DD}$  | 9.5   | 10.0  | 10.5  | V                | D          | Defines PSRR conditions  |
| Negative Supply, $V_{SS}$  | -6.0  | -5.75 | -5.5  | V                | D          | Defines PSRR conditions  |
| Logic Supply, $V_{CC}$   | 3.1   | 3.3   | 3.5   | V                | D          | Defines PSRR conditions  |
| Comparator Termination, $V_{COMP\_VTTX}$   | 1     | 1.5   | 3.3   | V                | D          |  |
| $V_{PLUS}$ Supply Current, $I_{PLUS}$  | -1.0  | +1.3  | +4.0  | mA               | P          | HVOUT disabled   |
| $V_{PLUS}$ Supply Current, $I_{PLUS}$  | 4.0   | 12.7  | 17.0  | mA               | P          | HVOUT enabled, RCVx pins active, no load, $V_{HH} = 12\text{ V}$   |
| Logic Supply Current, $I_{CC}$   | 1.0   | 2.7   | 10.0  | mA               | P          | Quiescent (SPI is static)  |
| Comparator Termination Current, $I_{COMP\_VTTX}$   | 40.0  | 46    | 70.0  | mA               | P          |  |
| Positive Supply Current, $I_{DD}$  | 140.0 | 190   | 256.0 | mA               | P          | Load power down ( $I_{OH} = I_{OL} = 0\text{ mA}$ )  |
|  | 170.0 | 231   | 311.0 | mA               | P          | Load active off ( $I_{OH} = I_{OL} = 12\text{ mA}$ )   |
| Negative Supply Current, $I_{SS}$  | 200.0 | 272   | 406.0 | mA               | P          | Load power down ( $I_{OH} = I_{OL} = 0\text{ mA}$ )  |
|  | 230.0 | 311   | 461.0 | mA               | P          | Load active off ( $I_{OH} = I_{OL} = 12\text{ mA}$ )   |
| Total Power Dissipation  | 2.5   | 3.55  | 4.0   | W                | P          | Load power down ( $I_{OH} = I_{OL} = 0\text{ mA}$ )  |
|  | 3.0   | 4.2   | 5.5   | W                | P          | Load active off ( $I_{OH} = I_{OL} = 12\text{ mA}$ )   |
| <b>TEMPERATURE MONITORS</b>  |       |       |       |                  |            |  |
| Temperature Sensor Gain  |       | 10    |       | mV/K             | $C_T$      |  |
| Temperature Sensor Accuracy Without Calibration over $25^\circ\text{C}$ to $100^\circ\text{C}$ |       | 6     |       | $^\circ\text{C}$ | $C_T$      | Temperature voltage available on Pin A1 at all times and on Pin K1 when selected (see Table 25 and Table 37)   |
| <b>VREF INPUT</b>  |       |       |       |                  |            |  |
| Reference Input Voltage Range for DACs (VREF Pin)  | 4.95  | 5     | 5.05  | V                | D          | Referenced to $V_{REF\_GND}$ ; not referenced to $V_{DUTGND}$  |
| Input Bias Current   |       | 0.08  | 100   | $\mu\text{A}$    | P          | Tested with 5 V applied  |

**DRIVER**

VH – VL ≥ 200 mV (to meet dc/ac specifications).

**Table 2.**

| Parameter   | Min   | Typ  | Max   | Unit  | Test Level       | Conditions/Comments  |
|---|-------|------|-------|-------|------------------|--|
| <b>DC SPECIFICATIONS</b>  |       |      |       |       |                  |  |
| High-Speed Differential Logic Input Characteristics (DATAx, RCVx) |       |      |       |       |                  |  |
| Input Termination Resistance                                      | 92    | 100  | 108   | Ω     | P                | Push 6 mA into xP pins, force 1.3 V on xN pins; measure voltage from xP to xN, calculate resistance (V/I)  |
| Input Voltage Differential  | 0.2   |      | 1.0   | V     | P <sub>F</sub>   |  |
| Common-Mode Voltage   | 0.85  |      | 3.5   | V     | P <sub>F</sub>   |  |
| Input Bias Current  | -20.0 | +4.0 | +20.0 | μA    | P                | Each pin tested at 2.85 V and 0.35 V, while other high speed pin left open   |
| Pin Output Characteristics  |       |      |       |       |                  |  |
| Output High Range, VH   | -1.9  |      | +6.0  | V     | D                |  |
| Output Low Range, VL  | -2.0  |      | +5.9  | V     | D                |  |
| Output Term Range, VT   | -2.0  |      | +6.0  | V     | D                |  |
| Functional Amplitude (VH – VL)                                    | 0.0   | 8.0  |       | V     | D                | Amplitude can be programmed to VH = VL, accuracy specifications apply when VH – VL ≥ 200 mV  |
| DC Output Current Limit Source                                    | 75    | 100  | 120   | mA    | P                | Driver high, VH = 6.0 V, short DUTx pin to -2.0 V, measure current   |
| DC Output Current Limit Sink                                      | -120  | -100 | -75   | mA    | P                | Driver low, VL = -2.0 V, short DUTx pin to 6.0 V, measure current  |
| Output Resistance, ±50 mA   | 45.0  | 48.5 | 51.0  | Ω     | P                | Source: driver high, VH = 3.0 V, I <sub>DUTx</sub> = 1 mA and 50 mA; sink: driver low, VL = 0.0 V, I <sub>DUTx</sub> = -1 mA and -50 mA; ΔV <sub>DUTx</sub> /ΔI <sub>DUTx</sub>  |
| <b>ABSOLUTE ACCURACY</b>  |       |      |       |       |                  |  |
| VH, VL, VT Uncalibrated Accuracy                                  | -300  | ±75  | +300  | mV    | P                | VH tests done with VL = -2.5 V and VT = -2.5 V; VL tests done with VH = 7.5 V and VT = 7.5 V; VT tests done with VL = -2.5 V and VH = 7.5 V; unless otherwise specified  |
| VH, VL, VT Offset Tempco  |       | ±450 |       | μV/°C | C <sub>T</sub>   | Error measured at calibration points of 0 V and 5 V  |
| VH, VL, VT DNL  |       | ±1   |       | mV    | C <sub>T</sub>   | Measured at calibration points   |
| VH, VL, VT INL  | -10   | ±2.5 | +10   | mV    | P                | After two-point gain/offset calibration  |
| VH, VL, VT Resolution   |       | 0.6  | 1     | mV    | P <sub>F</sub>   | After two-point gain/offset calibration; measured over driver output ranges  |
| DUTGND Voltage Accuracy   | -7    | ±1.3 | +7    | mV    | P                | After two-point gain/offset calibration; range/number of DAC bits as measured at calibration points of 0 V and 5 V   |
| VH, VL, VT Crosstalk  |       | ±2   |       | mV    | C <sub>T</sub>   | Over ±0.1 V range; measured at end points of VH, VL, and VT functional range   |
| Overall Voltage Accuracy  |       | ±10  |       | mV    | C <sub>T</sub>   | VL = -2.0 V: VH = -1.9 V → 6.0 V, VT = -2.0 V → 6.0 V; VH = 6.0 V: VL = -2.0 V → 5.9 V, VT = -2.0 V → 6.0 V; VT = 1.5 V: VL = -2.0 V → 5.9 V, VH = -1.9 V → 6.0 V; dc crosstalk on VL, VH, VT output level when other driver DACs are varied |
| VH, VL, VT DC PSRR  |       | ±15  |       | mV/V  | C <sub>T</sub>   | Sum of INL, crosstalk, DUTGND, and tempco over ±5°C, after gain/offset calibration   |
| <b>AC SPECIFICATIONS</b>  |       |      |       |       |                  |  |
| Rise/Fall Times   |       |      |       |       |                  | Toggle DATAx pins  |
| 0.2 V Programmed Swing  |       | 683  |       | ps    | C <sub>B</sub>   | VH = 0.2 V, VL = 0.0 V, terminated; 20% to 80%   |
| 1.0 V Programmed Swing  |       | 521  |       | ps    | C <sub>B</sub>   | VH = 1.0 V, VL = 0.0 V, terminated; 20% to 80%   |
| 1.8 V Programmed Swing  | 430   | 524  | 630   | ps    | P/C <sub>B</sub> | VH = 1.8 V, VL = 0.0 V, terminated; 20% to 80%   |
| 2.0 V Programmed Swing  |       | 531  |       | ps    | C <sub>B</sub>   | VH = 2.0 V, VL = 0.0 V, terminated; 20% to 80%   |
| 3.0 V Programmed Swing  |       | 589  |       | ps    | C <sub>B</sub>   | VH = 3.0 V, VL = 0.0 V, terminated; 20% to 80%   |
| 3.0 V Programmed Swing  |       | 811  |       | ps    | C <sub>B</sub>   | VH = 3.0 V, VL = 0.0 V, unterminated; 10% to 90%   |
| 5.0 V Programmed Swing  |       | 1105 |       | ps    | C <sub>B</sub>   | VH = 5.0 V, VL = 0.0 V, unterminated; 10% to 90%   |
| Rise to Fall Matching   |       | 6    |       | ps    | C <sub>B</sub>   | VH = 1.0 V, VL = 0.0 V, terminated; rise to fall within one channel  |

# ADATE302-02

| Parameter  | Min | Typ   | Max | Unit  | Test Level     | Conditions/Comments   |
|--|-----|-------|-----|-------|----------------|---|
| Minimum Pulse Width  |     |       |     |       |                | Toggle DATAx pins   |
| 2.0 V Programmed Swing   |     | 1.2   |     | ns    | C <sub>B</sub> | VH = 2.0 V, VL = 0.0 V, terminated; timing error ±27 ps                 |
|  |     | 1.2   |     | ns    | C <sub>B</sub> | VH = 2.0 V, VL = 0.0 V, terminated; less than 10% amplitude degradation |
|  |     | 1.0   |     | ns    | C <sub>B</sub> | VH = 2.0 V, VL = 0.0 V, terminated; less than 20% amplitude degradation |
| Maximum Toggle Rate  |     | 500   |     | MHz   | C <sub>B</sub> | VH = 2.0 V, VL = 0.0 V, terminated, 18% amplitude degradation           |
| Dynamic Performance, Drive (VH to VL and VL to VH)             |     |       |     |       |                | Toggle DATAx pins   |
| Propagation Delay Time   |     | 2.1   |     | ns    | C <sub>B</sub> | VH = 2.0 V, VL = 0.0 V, terminated                                      |
| Propagation Delay Tempco                                       |     | 4.5   |     | ps/°C | C <sub>T</sub> | VH = 1.8 V, VL = 0.0 V, terminated                                      |
| Delay Matching   |     |       |     |       |                | VH = 2.0 V, VL = 0.0 V, terminated                                      |
| Edge to Edge   |     | 41    |     | ps    | C <sub>B</sub> | Rising vs. falling  |
| Channel to Channel   |     | ±15   |     | ps    | C <sub>B</sub> | Rising vs. rising, falling vs. falling                                  |
| Delay Change vs. Duty Cycle                                    |     | ±30   |     | ps    | C <sub>B</sub> | VH = 3.0 V, VL = 0.0 V, terminated; 5% to 95% duty cycle; 1 MHz         |
| Overshoot and Undershoot                                       |     | 48    |     | mV    | C <sub>B</sub> | VH = 3.0 V, VL = 0.0 V, terminated                                      |
| Settling Time (VH to VL)                                       |     |       |     |       |                | Toggle DATAx pins   |
| To Within 3% of Final Value                                    |     | 1.2   |     | ns    | C <sub>B</sub> | VH = 3.0 V, VL = 0.0 V, terminated                                      |
| To Within 1% of Final Value                                    |     | 14    |     | ns    | C <sub>B</sub> | VH = 3.0 V, VL = 0.0 V, terminated                                      |
| Dynamic Performance, VTERM (VH or VL to VT and VT to VH or VL) |     |       |     |       |                | Toggle RCVx pins  |
| Propagation Delay Time   |     | 2.7   |     | ns    | C <sub>B</sub> | VH = 3.0 V, VT = 1.5 V, VL = 0.0 V, terminated                          |
| Delay Matching, Edge to Edge                                   |     | 59    |     | ps    | C <sub>B</sub> | VH = 3.0 V, VT = 1.5 V, VL = 0.0 V, terminated; rising vs. falling      |
| Propagation Delay Tempco                                       |     | 5.5   |     | ps/°C | C <sub>T</sub> | VH = 3.0 V, VT = 1.5 V, VL = 0.0 V, terminated                          |
| Transition Time, Active to VT, VT to Active                    |     | 0.614 |     | ns    | C <sub>B</sub> | VH = 3.0 V, VT = 1.5 V, VL = 0.0 V, terminated; 20% to 80%              |
| Dynamic Performance, Inhibit (VH or VL to/from Inhibit)        |     |       |     |       |                | Toggle RCVx pins  |
| Propagation Delay Time   |     |       |     |       |                | VH = +1.0 V, VL = -1.0 V, terminated                                    |
| Active to Inhibit  |     | 2.7   |     | ns    | C <sub>B</sub> |   |
| Inhibit to Active  |     | 3.7   |     | ns    | C <sub>B</sub> |   |
| Transition Time  |     |       |     |       |                | VH = +1.0 V, VL = -1.0 V, terminated; 20% to 80%                        |
| Active to Inhibit  |     | 1.3   |     | ns    | C <sub>B</sub> |   |
| Inhibit to Active  |     | 0.4   |     | ns    | C <sub>B</sub> |   |
| I/O Spike  |     | 157   |     | mV    | C <sub>B</sub> | VH = 0.0 V, VL = 0.0 V, terminated                                      |

**REFLECTION CLAMP**

Clamp accuracy specifications apply when VCH > VCL.

**Table 3.**

| Parameter               | Min  | Typ  | Max  | Unit  | Test Level     | Conditions/Comments  |
|-------------------------|------|------|------|-------|----------------|--|
| VCH                     |      |      |      |       |                |  |
| Range                   | -1.0 |      | +6.0 | V     | D              |  |
| Uncalibrated Accuracy   | -200 | ±45  | +200 | mV    | P              | Driver high-Z, sinking 1 mA; VCH error measured at calibration points of 0 V and 5 V   |
| Resolution              |      | 0.6  | 0.75 | mV    | P <sub>F</sub> | Driver high-Z, sinking 1 mA; after two-point gain/offset calibration; range/number of DAC bits as measured at calibration points of 0 V and 5 V  |
| DNL                     |      | ±1   |      | mV    | C <sub>T</sub> | Driver high-Z, sinking 1 mA; after two-point gain/offset calibration   |
| INL                     | -40  | ±2   | +40  | mV    | P              | Driver high-Z, sinking 1 mA; after two-point gain/offset calibration; measured over VCH range of -1 V to +6 V                                    |
| Tempco                  |      | -0.5 |      | mV/°C | C <sub>T</sub> | Measured at calibration points   |
| VCL                     |      |      |      |       |                |  |
| Range                   | -2   |      | +5.0 | V     | D              |  |
| Uncalibrated Accuracy   | -200 | ±70  | +200 | mV    | P              | Driver high-Z, sourcing 1 mA; VCL error measured at calibration points of 0 V and 5 V  |
| Resolution              |      | 0.6  | 0.75 | mV    | P <sub>F</sub> | Driver high-Z, sourcing 1 mA; after two-point gain/offset calibration; range/number of DAC bits as measured at calibration points of 0 V and 5 V |
| DNL                     |      | ±1   |      | mV    | C <sub>T</sub> | Driver high-Z, sourcing 1 mA; after two-point gain/offset calibration  |
| INL                     | -40  | ±2   | +40  | mV    | P              | Driver high-Z, sourcing 1 mA; after two-point gain/offset calibration; measured over VCL range of -2 V to +5 V                                   |
| Tempco                  |      | 0.6  |      | mV/°C | C <sub>T</sub> | Measured at calibration points   |
| DC CLAMP CURRENT LIMIT  |      |      |      |       |                |  |
| VCH                     | -120 | -83  | -60  | mA    | P              | Driver high-Z, VCH = 0 V, VCL = -2.0 V, V <sub>DUTx</sub> = 5 V  |
| VCL                     | 60   | 86   | 120  | mA    | P              | Driver high-Z, VCH = 6.0 V, VCL = 5.0 V, V <sub>DUTx</sub> = 0.0 V   |
| DUTGND VOLTAGE ACCURACY | -7   | ±1   | +7   | mV    | P              | Over ±0.1 V range; measured at the end points of VCH and VCL functional range  |

**NORMAL WINDOW COMPARATOR**

VOH tests done with VOL = -2.0 V, VOL tests done with VOH = 6.0 V, unless otherwise specified.

**Table 4.**

| Parameter  | Min  | Typ  | Max  | Unit  | Test Level     | Conditions/Comments  |
|--|------|------|------|-------|----------------|--|
| DC SPECIFICATIONS                                      |      |      |      |       |                |  |
| Input Voltage Range                                    | -2.0 |      | +6.0 | V     | D              |  |
| Differential Voltage Range                             | ±0.1 |      | ±8.0 | V     | D              |  |
| Comparator Input Offset Voltage Accuracy, Uncalibrated | -150 | ±30  | +150 | mV    | P              | Offset measured at calibration points of 0 V and 5 V   |
| Comparator Threshold Resolution                        |      | 0.61 | 1    | mV    | P <sub>F</sub> | After two-point gain/offset calibration; range/number of DAC bits as measured at calibration points of 0 V and 5 V |
| Comparator Threshold DNL                               |      | ±1   |      | mV    | C <sub>T</sub> | After two-point gain/offset calibration  |
| Comparator Threshold INL                               | -7   | ±1.2 | +7   | mV    | P              | After two-point gain/offset calibration; measured over VOH, VOL range of -2.0 V to +6.0 V                          |
| Comparator Input Offset Voltage Tempco                 |      | ±200 |      | µV/°C | C <sub>T</sub> | Measured at calibration points   |

# ADATE302-02

| Parameter  | Min                            | Typ                            | Max                    | Unit  | Test Level     | Conditions/Comments   |
|--|--------------------------------|--------------------------------|------------------------|-------|----------------|---|
| DUTGND Voltage Accuracy                                  | -7                             | ±0.5                           | +7                     | mV    | P              | Over ±0.1 V range; measured at end points of VOH and VOL functional range   |
| Comparator Uncertainty Range                             |                                | 5.3                            |                        | mV    | C <sub>B</sub> | V <sub>DUTx</sub> = 0 V, sweep comparator threshold to determine uncertainty region   |
| DC Hysteresis  |                                | 0.5                            |                        | mV    | C <sub>B</sub> | V <sub>DUTx</sub> = 0 V   |
| DC PSRR  |                                | ±5                             |                        | mV/V  | C <sub>T</sub> | Measured at calibration points  |
| Digital Output Characteristics                           |                                |                                |                        |       |                |   |
| Internal Pull-Up Resistance to Comparator, COMP_VTTx Pin | 46                             | 50                             | 54                     | Ω     | P              | Pull 1 mA and 10 mA from Logic 1 leg and measure ΔV to calculate resistance; measured ΔV/9 mA; done for both comparator logic states  |
| V <sub>COMP_VTTx</sub> Range                             | 1                              | 1.5                            | 3.3                    | V     | D              |   |
| Common-Mode Voltage                                      |                                | V <sub>COMP_VTTx</sub><br>-0.3 |                        | V     | C <sub>T</sub> | Measured with 100 Ω differential termination  |
|  | V <sub>COMP_VTTx</sub><br>-0.5 |                                | V <sub>COMP_VTTx</sub> | V     | P              | Measured with no external termination   |
| Differential Voltage                                     |                                | 250                            |                        | mV    | C <sub>T</sub> | Measured with 100 Ω differential termination  |
|  | 450                            | 500                            | 550                    | mV    | P              | Measured with no external termination   |
| Rise/Fall Time, 20% to 80%                               |                                | 222                            |                        | ps    | C <sub>B</sub> | Measured with each comparator leg terminated 50 Ω to GND  |
| AC SPECIFICATIONS  |                                |                                |                        |       |                | Input transition time = 600 ps, 10% to 90%; measured with each comparator leg terminated 50 Ω to GND; unless otherwise specified  |
| Propagation Delay, Input to Output                       |                                | 1.4                            |                        | ns    | C <sub>B</sub> | V <sub>DUTx</sub> = 0 V to 1.0 V swing, driver VTERM mode, VT = 0.0 V; high-side measurement: VOH = 0.5 V, VOL = -2.0 V; low-side measurement: VOH = 6.0 V, VOL = 0.5 V   |
| Propagation Delay Tempco                                 |                                | 4                              |                        | ps/°C | C <sub>T</sub> | V <sub>DUTx</sub> = 0 V to 0.9 V swing, driver VTERM mode, VT = 0.0 V; VOL = VOH = 0.45 V   |
| Propagation Delay Matching                               |                                |                                |                        |       |                | V <sub>DUTx</sub> = 0 V to 1.0 V swing, driver VTERM mode, VT = 0.0 V; high-side measurement: VOH = 0.5 V, VOL = -2.0 V; low-side measurement: VOH = 6.0 V, VOL = 0.5 V   |
| High Transition to Low Transition                        |                                | 39                             |                        | ps    | C <sub>B</sub> |   |
| High to Low Comparator                                   |                                | ±30                            |                        | ps    | C <sub>B</sub> |   |
| Propagation Delay Change with Respect to                 |                                |                                |                        |       |                |   |
| Slew Rate, 600 ps and 1 ns (10% to 90%)                  |                                | 19                             |                        | ps    | C <sub>B</sub> | V <sub>DUTx</sub> = 0 V to 0.5 V swing, driver VTERM mode, VT = 0.0 V; high-side measurement: VOH = 0.25 V, VOL = -2.0 V; low-side measurement: VOH = 6.0 V, VOL = 0.25 V   |
| Overdrive, 250 mV and 1.0 V                              |                                | 65                             |                        | ps    | C <sub>B</sub> | For 250 mV: V <sub>DUTx</sub> = 0 V to 0.5 V swing; for 1.0 V: V <sub>DUTx</sub> = 0 V to 1.25 V swing; driver VTERM mode, VT = 0.0 V; high-side measurement: VOH = 0.25 V, VOL = -2.0 V; low-side measurement: VOH = 6.0 V, VOL = 0.25 V; input transition time = 400 ps (10%/90%) |
| Pulse Width, 1 ns, 5 ns, 10 ns, and 15 ns                |                                | 27                             |                        | ps    | C <sub>B</sub> | V <sub>DUTx</sub> = 0 V to 1.0 V swing @ 32.0 MHz, driver VTERM mode, VT = 0.0 V; high-side measurement: VOH = 0.5 V, VOL = -2.0 V; low-side measurement: VOH = 6.0 V, VOL = 0.5 V; input transition time = 400 ps (10%/90%)  |
| Duty Cycle, 5% to 95%                                    |                                | 11.8                           |                        | ps    | C <sub>B</sub> | V <sub>DUTx</sub> = 0 V to 1.0 V swing @ 1.0 MHz, driver VTERM mode, VT = 0.0 V; high-side measurement: VOH = 0.5 V, VOL = -2.0 V; low-side measurement: VOH = 6.0 V, VOL = 0.5 V; input transition time = 400 ps (10%/90%)   |



| Parameter                              | Min | Typ  | Max | Unit | Test Level     | Conditions/Comments  |
|--|-----|------|-----|------|----------------|--|
| Minimum Pulse Width                    |     | 1    |     | ns   | C <sub>B</sub> | V <sub>DUTX</sub> = 0 V to 1.0 V swing, driver VTERM mode, VT = 0.0 V; less than 10% amplitude degradation measured by shmoo; input transition time = 400 ps (10%/90%) |
| Input Equivalent Bandwidth, Terminated |     | 1000 |     | MHz  | C <sub>B</sub> | V <sub>DUTX</sub> = 0 V to 1.0 V swing, driver VTERM mode, VT = 0.0 V; as measured by shmoo; input transition time = 400 ps (10%/90%)                                  |
| ERT High-Z Mode, 3 V, 20% to 80%       |     | 0.9  |     | ns   | C <sub>B</sub> | V <sub>DUTX</sub> = 0 V to 3.0 V swing, driver high-Z; as measured by shmoo  |

**DIFFERENTIAL COMPARATOR**

VOH tests done with VOL = -1.1 V, VOL tests done with VOH = 1.1 V, unless otherwise specified.

**Table 5.**

| Parameter  | Min   | Typ  | Max  | Unit  | Test Level     | Conditions/Comments  |
|--|-------|------|------|-------|----------------|--|
| <b>DC SPECIFICATIONS</b>                                 |       |      |      |       |                |  |
| Input Voltage Range                                      | -1.5  |      | +4.5 | V     | D              |  |
| Operational Differential Voltage Range                   | ±0.05 |      | ±1.1 | V     | D              |  |
| Maximum Differential Voltage Range                       |       |      | ±8   | V     | D              |  |
| Comparator Input Offset Voltage Accuracy, Uncalibrated   | -150  | ±25  | +150 | mV    | P              | Offset measured at differential calibration points of +1 V and -1 V, with common mode = 0 V  |
| VOH, VOL Resolution                                      |       | 0.61 | 1    | mV    | P <sub>F</sub> | After two-point gain/offset calibration; range/number of DAC bits as measured at differential calibration points of +1 V and -1 V, with common mode = 0 V  |
| VOH, VOL DNL   |       | ±1   |      | mV    | C <sub>T</sub> | After two-point gain/offset calibration; common mode = 0 V   |
| VOH, VOL INL   | -7    | ±1.0 | +7   | mV    | P              | After two-point gain/offset calibration; measured over VOH, VOL range of -1.1 V to +1.1 V, common mode = 0 V   |
| VOH, VOL Offset Voltage Tempco                           |       | ±200 |      | µV/°C | C <sub>T</sub> | Measured at calibration points   |
| Comparator Uncertainty Range                             |       | 18   |      | mV    | C <sub>B</sub> | V <sub>DUTX</sub> = 0 V, sweep comparator threshold to determine uncertainty region  |
| DC Hysteresis  |       | 0.5  |      | mV    | C <sub>B</sub> | V <sub>DUTX</sub> = 0 V  |
| CMRR   |       |      | 1    | mV/V  | P              | Offset measured at common-mode voltage points of -1.5 V and +4.5 V, with differential voltage = 0 V  |
| DC PSRR  |       | ±15  |      | mV/V  | C <sub>T</sub> | Measured at calibration points   |
| <b>AC SPECIFICATIONS</b>                                 |       |      |      |       |                |  |
| Propagation Delay, Input to Output                       |       | 1.4  |      | ns    | C <sub>B</sub> | Input transition time = 600 ps, 10% to 90%, measured with each comparator leg terminated 50 Ω to GND<br>V <sub>DUT0</sub> = 0 V, V <sub>DUT1</sub> = -0.5 V to +0.5 V swing, driver VTERM mode, VT = 0.0 V; high-side measurement: VOH = 0.0 V, VOL = -1.1 V; low-side measurement: VOH = 1.1 V, VOL = 0.0 V; repeat for other DUT channel |
| Propagation Delay Tempco                                 |       | 4    |      | ps/°C | C <sub>T</sub> | V <sub>DUT0</sub> = 0 V, V <sub>DUT1</sub> = -0.5 V to +0.5 V swing, driver VTERM mode, VT = 0.0 V; VOL = VOH = 0.0 V; repeat for other DUT channel  |
| Propagation Delay Matching                               |       |      |      |       |                | V <sub>DUT0</sub> = 0 V, V <sub>DUT1</sub> = -0.5 V to +0.5 V swing, driver VTERM mode, VT = 0.0 V; high-side measurement: VOH = 0.0 V, VOL = -1.1 V; low-side measurement: VOH = 1.1 V, VOL = 0.0 V; repeat for other DUT channel   |
| High Transition to Low Transition High to Low Comparator |       | 27   |      | ps    | C <sub>B</sub> |  |
| Propagation Delay Change with Respect to                 |       | ±32  |      | ps    | C <sub>B</sub> | V <sub>DUT0</sub> = 0 V, V <sub>DUT1</sub> = -0.5 V to +0.5 V swing, driver VTERM mode, VT = 0.0 V; high-side measurement: VOH = 0.0 V, VOL = -1.1 V; low-side measurement: VOH = 1.1 V,   |

# ADATE302-02

| Parameter                                 | Min | Typ | Max | Unit | Test Level     | Conditions/Comments   |
|---|-----|-----|-----|------|----------------|---|
| Slew Rate, 400 ps and 1 ns (10% to 90%)   |     | 25  |     | ps   | C <sub>B</sub> | VOL = 0.0 V; repeat for other DUT channel<br>V <sub>DUT0</sub> = 0 V, V <sub>DUT1</sub> = -0.5 V to +0.5 V swing, driver VTERM mode, VT = 0.0 V; high-side measurement: VOH = 0.0 V, VOL = -1.1 V; low-side measurement: VOH = 1.1 V, VOL = 0.0 V; repeat for other DUT channel           |
| Overdrive, 250 mV and 750 mV              |     | 79  |     | ps   | C <sub>B</sub> | V <sub>DUT0</sub> = 0 V, for 250 mV: V <sub>DUT1</sub> = 0 V to 0.5 V swing; for 750 mV: V <sub>DUT1</sub> = 0 V to 1.0 V swing, driver VTERM mode, VT = 0.0 V; VOH = -0.25 V; repeat for other DUT channel with comparator threshold = 0.25 V  |
| Pulse Width, 1 ns, 5 ns, 10 ns, and 15 ns |     | 56  |     | ps   | C <sub>B</sub> | V <sub>DUT0</sub> = 0 V, V <sub>DUT1</sub> = -0.5 V to +0.5 V swing @ 32 MHz, driver VTERM mode, VT = 0.0 V; high-side measurement: VOH = 0.0 V, VOL = -1.1 V; low-side measurement: VOH = 1.1 V, VOL = 0.0 V; repeat for other DUT channel   |
| Duty Cycle, 5% to 95%                     |     | 16  |     | ps   | C <sub>B</sub> | V <sub>DUT0</sub> = 0 V, V <sub>DUT1</sub> = -0.5 V to +0.5 V swing @ 32 MHz, driver VTERM mode, VT = 0.0 V; high-side measurement: VOH = 0.0 V, VOL = -1.1 V; low-side measurement: VOH = 1.1 V, VOL = 0.0 V; repeat for other DUT channel   |
| Minimum Pulse Width                       |     | 1   |     | ns   | C <sub>B</sub> | V <sub>DUT0</sub> = 0 V, V <sub>DUT1</sub> = -0.5 V to +0.5 V swing, driver VTERM mode, VT = 0.0 V; high-side measurement: VOH = 0.0 V, VOL = -1.1 V; low-side measurement: VOH = 1.1 V, VOL = 0.0 V; less than 22% amplitude degradation measured by shmoo; repeat for other DUT channel |
| Input Equivalent Bandwidth, Terminated    |     | 500 |     | MHz  | C <sub>B</sub> | V <sub>DUT0</sub> = 0 V, V <sub>DUT1</sub> = -0.5 V to +0.5 V swing, driver VTERM mode, VT = 0.0 V; high-side measurement: VOH = 0.0 V, VOL = -1.1 V; low-side measurement: VOH = 1.1 V, VOL = 0.0 V  |

**ACTIVE LOAD**

See Table 30 for load control information.

**Table 6.**

| Parameter  | Min    | Typ  | Max    | Unit  | Test Level     | Conditions/Comments  |
|--|--------|------|--------|-------|----------------|--|
| <b>DC SPECIFICATIONS</b>                                 |        |      |        |       |                |  |
| Load active on, RCVx pins active, unless otherwise noted |        |      |        |       |                |  |
| <b>Input Characteristics</b>                             |        |      |        |       |                |  |
| VCOM Voltage Range                                       | -1.75  |      | +5.75  | V     | D              |  |
| V <sub>DUTx</sub> Range                                  | -2.0   |      | +6.0   | V     | D              |  |
| VCOM Accuracy, Uncalibrated                              | -200   | ±25  | +200   | mV    | P              | IOH = IOL = 6 mA, VCOM error measured at calibration points of 0 V and 5 V   |
| VCOM Resolution  |        | 0.61 | 1      | mV    | P <sub>F</sub> | IOH = IOL = 6 mA, after two-point gain/offset calibration; range/number of DAC bits as measured at calibration points of 0 V and 5 V                                       |
| VCOM DNL   |        | ±1   |        | mV    | C <sub>T</sub> | IOH = IOL = 6 mA, after two-point gain/offset calibration  |
| VCOM INL   | -7     | ±2   | +7     | mV    | P              | IOH = IOL = 6 mA, after two-point gain/offset calibration; measured over VCOM range of -1.75 V to +5.75 V  |
| DUTGND Voltage Accuracy                                  | -7     | ±1   | +7     | mV    | P              | Over ±0.1 V range; measured at end points of VCOM functional range   |
| <b>Output Characteristics</b>                            |        |      |        |       |                |  |
| <b>IOL</b>   |        |      |        |       |                |  |
| Maximum Source Current                                   | 12     |      |        | mA    | D              |  |
| Uncalibrated Offset                                      | -600.0 | ±100 | +600.0 | µA    | P              | IOH = 0 mA, VCOM = 1.5 V, V <sub>DUTx</sub> = 0.0 V, IOL offset calculated from calibration points of 1 mA and 11 mA   |
| Uncalibrated Gain  | -12    | ±1   | +12    | %     | P              | IOH = 0 mA, VCOM = 1.5 V, V <sub>DUTx</sub> = 0.0 V, IOL gain calculated from calibration points of 1 mA and 11 mA   |
| Resolution   |        | 1.5  | 2      | µA    | P <sub>F</sub> | IOH = 0 mA, VCOM = 1.5 V, V <sub>DUTx</sub> = 0.0 V, after two-point gain/offset calibration; range/number of DAC bits as measured at calibration points of 1 mA and 11 mA |
| DNL  |        | ±3.0 |        | µA    | C <sub>T</sub> | IOH = 0 mA, VCOM = 1.5 V, V <sub>DUTx</sub> = 0.0 V, after two-point gain/offset calibration   |
| INL  | -70    | ±20  | +70    | µA    | P              | IOH = 0 mA, VCOM = 1.5 V, V <sub>DUTx</sub> = 0.0 V, after two-point gain/offset calibration; measured over IOL range of 0 mA to 12 mA                                     |
| 90% Commutation Voltage                                  |        |      | 0.25   | V     | P              | IOH = IOL = 12 mA, VCOM = 2.0 V, measure IOL reference at V <sub>DUTx</sub> = -1.0 V, measure IOL current at V <sub>DUTx</sub> = 1.75 V, ensure >90% of reference current  |
| <b>IOH</b>   |        |      |        |       |                |  |
| Maximum Sink Current                                     | 12     |      |        | mA    | D              |  |
| Uncalibrated Offset                                      | -600.0 | ±100 | +600.0 | µA    | P              | IOL = 0 mA, VCOM = 1.5 V, V <sub>DUTx</sub> = 3.0 V, IOH offset calculated from calibration points of 1 mA and 11 mA   |
| Uncalibrated Gain  | -12    | ±1   | +12    | %     | P              | IOL = 0 mA, VCOM = 1.5 V, V <sub>DUTx</sub> = 3.0 V, IOH gain calculated from calibration points of 1 mA and 11 mA   |
| Resolution   |        | 1.5  | 2      | µA    | P <sub>F</sub> | IOL = 0 mA, VCOM = 1.5 V, V <sub>DUTx</sub> = 3.0 V, after two-point gain/offset calibration; range/number of DAC bits as measured at calibration points of 1 mA and 11 mA |
| DNL  |        | ±3.0 |        | µA    | C <sub>T</sub> | IOL = 0 mA, VCOM = 1.5V, V <sub>DUTx</sub> = 3.0 V, after two-point gain/offset calibration  |
| INL  | -70    | ±20  | +70    | µA    | P              | IOL = 0 mA, VCOM = 1.5V, V <sub>DUTx</sub> = 3.0 V, after two-point gain/offset calibration; measured over IOH range of 0 mA to 12 mA                                      |
| 90% Commutation Voltage                                  |        |      | 0.25   | V     | P              | IOH = IOL = 12 mA, VCOM = 2.0 V, measure IOH reference at V <sub>DUTx</sub> = 5.0 V, measure IOH current at V <sub>DUTx</sub> = 2.25 V, ensure >90% of reference current   |
| Output Current Tempco                                    |        | ±1.5 |        | µA/°C | C <sub>T</sub> | Measured at calibration points   |

# ADATE302-02

| Parameter  | Min | Typ | Max | Unit | Test Level     | Conditions/Comments  |
|--|-----|-----|-----|------|----------------|--|
| AC SPECIFICATIONS  |     |     |     |      |                |  |
| Dynamic Performance  |     |     |     |      |                |  |
| Propagation Delay, Load Active On to Load Active Off; 50%, 90% |     | 4.1 |     | ns   | C <sub>B</sub> | Toggle RCVx pins, DUTx terminated 50 Ω to GND, IOH = IOL = 12 mA, VH = VL = 0 V, VCOM = +1.25 V for IOL and VCOM = -1.25 V for IOH; measured from 50% point of RCVxP - RCVxN to 90% point of final output, repeat for drive low and high |
| Propagation Delay, Load Active Off to Load Active On; 50%, 90% |     | 11  |     | ns   | C <sub>B</sub> | Toggle RCVx pins, DUTx terminated 50 Ω to GND, IOH = IOL = 12 mA, VH = VL = 0 V, VCOM = +1.25 V for IOL and VCOM = -1.25 V for IOH; measured from 50% point of RCVxP - RCVxN to 90% point of final output, repeat for drive low and high |
| Propagation Delay Matching                                     |     | 6.9 |     | ns   | C <sub>B</sub> | Toggle RCVx pins, DUTx terminated 50 Ω to GND, IOH = IOL = 12 mA, VH = VL = 0 V, VCOM = +1.25 V for IOL and VCOM = -1.25 V for IOH; active on vs. active off, repeat for drive low and high  |
| Load Spike   |     | 156 |     | mV   | C <sub>B</sub> | Toggle RCVx pins, DUTx terminated 50 Ω to GND, IOH = IOL = 0 mA, VH = VL = 0 V, VCOM = +1.25 V for IOL and VCOM = -1.25 V for IOH; repeat for drive low and high   |
| Settling Time to 90%   |     | 1.6 |     | ns   | C <sub>B</sub> | Toggle RCVx pins, DUTx terminated 50 Ω to GND, IOH = IOL = 12 mA, VH = VL = 0 V, VCOM = +1.25 V for IOL and VCOM = -1.25 V for IOH; measured at 90% of final value   |

## PMU

FV = force voltage, MV = measure voltage, FI = force current, MI = measure current, FN = force nothing.

Table 7.

| Parameter  | Min  | Typ | Max  | Unit   | Test Level     | Conditions/Comments   |
|--|------|-----|------|--------|----------------|---|
| FORCE VOLTAGE (FV)                                 |      |     |      |        |                |   |
| Current Range A                                    | ±25  |     |      | mA     | D              |   |
| Current Range B                                    | ±2   |     |      | mA     | D              |   |
| Current Range C                                    | ±200 |     |      | μA     | D              |   |
| Current Range D                                    | ±20  |     |      | μA     | D              |   |
| Current Range E                                    | ±2   |     |      | μA     | D              |   |
| Force Input Voltage Range at Output For All Ranges | -2.0 |     | +6.0 | V      | D              |   |
| Force Voltage Uncalibrated Accuracy for Range C    | -100 | ±25 | +100 | mV     | P              | PMU enabled, FV, PE disabled, error measured at calibration points of 0 V and 5 V   |
| Force Voltage Uncalibrated Accuracy for All Ranges |      | ±25 |      | mV     | C <sub>T</sub> | PMU enabled, FV, PE disabled, error measured at calibration points of 0 V and 5 V; repeat for each PMU current range  |
| Force Voltage Offset Tempco for All Ranges         |      | ±25 |      | μV/°C  | C <sub>T</sub> | Measured at calibration points for each PMU current range   |
| Force Voltage Gain Tempco for All Ranges           |      | ±75 |      | ppm/°C | C <sub>T</sub> | Measured at calibration points for each PMU current range   |
| Forced Voltage INL                                 | -7   | ±2  | +7   | mV     | P              | PMU enabled, FV, Range C, PE disabled, after two-point gain/offset calibration; measured over output range of -2.0 V to +6.0 V  |
| Force Voltage Compliance vs. Current Load          |      |     |      |        |                | PMU enabled, FV, PE disabled, force -2.0 V, measure voltage while PMU sinking zero- and full-scale current; measure ΔV; force 6.0 V, measure voltage while PMU sourcing zero- and full-scale current; measure ΔV; repeat for each PMU current range |
| Range A  |      | ±4  |      | mV     | C <sub>T</sub> |   |
| Range B to Range E                                 |      | ±1  |      | mV     | C <sub>T</sub> |   |

| Parameter  | Min   | Typ    | Max  | Unit    | Test Level     | Conditions/Comments   |
|--|-------|--------|------|---------|----------------|---|
| Current Limit, Source and Sink                         |       |        |      |         |                |   |
| Range A  | 108   | 135    | 180  | % FS    | P              | PMU enabled, FV, PE disabled; sink: force 2.5 V, short DUTx to 6.0 V; source: force 2.5 V, short DUTx to -1.0 V; Range A FS = 25 mA, 108% FS = 27 mA, 180% FS = 45 mA   |
| Range B to Range E                                     | 120   | 140    | 180  | % FS    | P              | PMU enabled, FV, PE disabled; sink: force 2.5 V, short DUTx to 6.0 V; source: force 2.5 V, short DUTx to -1.0 V; repeat for each PMU current range; example: Range B FS = 2 mA, 120% FS = 2.4 mA, 180% FS = 3.6 mA  |
| DUTGND Voltage Accuracy                                | -7    | ±1     | +7   | mV      | P              | Over ±0.1 V range; measured at end points of FV functional range  |
| MEASURE CURRENT (MI)                                   |       |        |      |         |                | $V_{DUTx}$ externally forced to 0.0 V, unless otherwise specified; ideal MEASOUT transfer functions:<br>$V_{MEASOUT01} [V] = (I_{MEASOUT01} \times 5/FSR) + 2.5 + V_{DUTGND}$<br>$I(V_{MEASOUT01}) [A] = (V_{MEASOUT01} - V_{DUTGND} - 2.5) \times FSR/5$ |
| Measure Current, Pin DUTx Voltage Range for All Ranges | -2.0  |        | +6.0 | V       | D              |   |
| Measure Current Uncalibrated Accuracy                  |       |        |      |         |                |   |
| Range A  |       | ±650   |      | µA      | C <sub>T</sub> | PMU enabled, FIMI, PE disabled, error at calibration points of -20 mA and 20 mA, error = $(I(V_{MEASOUT01}) - I_{DUTx})$  |
| Range B  | -400  | ±20    | +400 | µA      | P              | PMU enabled, FIMI, PE disabled, error at calibration points of -1.6 mA and 1.6 mA, error = $(I(V_{MEASOUT01}) - I_{DUTx})$  |
| Range C  |       | ± 2.00 |      | µA      | C <sub>T</sub> | PMU enabled, FIMI, PE disabled, error at calibration points of ±80% FS, error = $(I(V_{MEASOUT01}) - I_{DUTx})$   |
| Range D  |       | ±0.20  |      | µA      | C <sub>T</sub> | PMU enabled, FIMI, PE disabled, error at calibration points of ±80% FS, error = $(I(V_{MEASOUT01}) - I_{DUTx})$   |
| Range E  |       | ±0.02  |      | µA      | C <sub>T</sub> | PMU enabled, FIMI, PE disabled, error at calibration points of ±80% FS, error = $(I(V_{MEASOUT01}) - I_{DUTx})$   |
| Measure Current Offset Tempco                          |       |        |      |         |                |   |
| Range A  |       | ±2.5   |      | µA/°C   | C <sub>T</sub> | Measured at calibration points  |
| Range B  |       | ±125   |      | nA/°C   | C <sub>T</sub> | Measured at calibration points  |
| Range C  |       | ±20    |      | nA/°C   | C <sub>T</sub> | Measured at calibration points  |
| Range D and Range E                                    |       | ±4     |      | nA/°C   | C <sub>T</sub> | Measured at calibration points  |
| Measure Current Gain Error, Nominal Gain = 1           |       |        |      |         |                |   |
| Range A  |       | -3.5   |      | %       | C <sub>T</sub> | PMU enabled, FIMI, PE disabled, gain error from calibration points of ±80% FS   |
| Range B  | -20   | ±2     | +20  | %       | P              | PMU enabled, FIMI, PE disabled, gain error from calibration points of ±1.6 mA   |
| Range C to Range E                                     |       | ±2     |      | %       | C <sub>T</sub> | PMU enabled, FIMI, PE disabled, gain error from calibration points of ±80% FS   |
| Measure Current Gain Tempco                            |       |        |      |         |                |   |
| Range A  |       | ±300   |      | ppm/°C  | C <sub>T</sub> | Measured at calibration points  |
| Range B to Range E                                     |       | ±50    |      | ppm/°C  | C <sub>T</sub> | Measured at calibration points  |
| Measure Current INL                                    |       |        |      |         |                |   |
| Range A  |       | ±0.05  |      | % FSR   | C <sub>T</sub> | PMU enabled, FIMI, PE disabled, after two-point gain/offset calibration, measured over FSR output of -25 mA to +25 mA   |
| Range B  | -0.02 | ±0.005 | 0.02 | % FSR   | P              | PMU enabled, FIMI, PE disabled, after two-point gain/offset calibration measured over FSR output of -2 mA to +2 mA  |
| Range B to Range E                                     |       | ±0.005 |      | % FSR   | C <sub>T</sub> | PMU enabled, FIMI, PE disabled, after two-point gain/offset calibration; measured over FSR output   |
| FVMI DUT Pin Voltage Rejection                         | -0.01 |        | 0.01 | % FSR/V | P              | PMU enabled, FVMI, PE disabled, force -1 V and +5 V into load of 1 mA; measure $\Delta I$ reported at MEASOUT01   |
| DUTGND Voltage Accuracy                                |       | ±2.5   |      | mV      | C <sub>T</sub> | Over ±0.1 V range; measured at end points of MI functional range  |

# ADATE302-02

| Parameter  | Min  | Typ    | Max  | Unit   | Test Level     | Conditions/Comments  |
|--|------|--------|------|--------|----------------|--|
| FORCE CURRENT (FI)                                   |      |        |      |        |                | $V_{DUTx}$ externally forced to 0.0 V, unless otherwise specified<br>Ideal force current transfer function:<br>$I_{FORCE} = (PMUDAC - 2.5) \times (FSR/5)$   |
| Force Current, DUTx Pin Voltage Range for All Ranges | -2.0 |        | +6.0 | V      | D              |  |
| Force Current Uncalibrated Accuracy                  |      |        |      |        |                |  |
| Range A  | -5.0 | ±0.5   | +5.0 | mA     | P              | PMU enabled, FIMI, PE disabled, error at calibration points of -20 mA and +20 mA   |
| Range B  | -400 | ±40    | +400 | µA     | P              | PMU enabled, FIMI, PE disabled, error at calibration points of -1.6 mA and +1.6 mA   |
| Range C  | -40  | ±4     | +40  | µA     | P              | PMU enabled, FIMI, PE disabled, error at calibration points of ±80% FS   |
| Range D  | -4   | ±0.4   | +4   | µA     | P              | PMU enabled, FIMI, PE disabled, error at calibration points of ±80% FS   |
| Range E  | -400 | ±75    | +400 | nA     | P              | PMU enabled, FIMI, PE disabled, error at calibration points of ±80% FS   |
| Force Current Offset Tempco                          |      |        |      |        |                |  |
| Range A  |      | ±1     |      | µA/°C  | C <sub>T</sub> | Measured at calibration points   |
| Range B  |      | ±80    |      | nA/°C  | C <sub>T</sub> | Measured at calibration points   |
| Range C to Range E                                   |      | ±4     |      | nA/°C  | C <sub>T</sub> | Measured at calibration points   |
| Forced Current Gain Error, Nominal Gain = 1          | -20  | ±4     | +20  | %      | P              | PMU enabled, FIMI, PE disabled, gain error from calibration points of ±80% FS  |
| Forced Current Gain Tempco                           |      |        |      |        |                | Measured at calibration points   |
| Range A  |      | -500   |      | ppm/°C | C <sub>T</sub> |  |
| Range B to Range E                                   |      | ±75    |      | ppm/°C | C <sub>T</sub> |  |
| Force Current INL                                    |      |        |      |        |                |  |
| Range A  | -0.3 | ±0.05  | +0.3 | % FSR  | P              | PMU enabled, FIMI, PE disabled, after two-point gain/offset calibration; measured over FSR output of -25 mA to +25 mA  |
| Range B to Range E                                   | -0.2 | ±0.015 | 0.2  | % FSR  | P              | PMU enabled, FIMI, PE disabled, after two-point gain/offset calibration; measured over FSR output  |
| Force Current Compliance vs. Voltage Load            |      |        |      |        |                | PMU enabled, FIMV, PE disabled; force positive full-scale current driving -2.0 V and +6.0 V, measure $\Delta I$ @ DUTx pin; force negative full-scale current driving -2.0 V and +6.0 V, measure $\Delta I$ @ DUTx pin |
| Range A to Range D                                   | -0.6 | ±0.06  | +0.6 | % FSR  | P              |  |
| Range E  | -1.0 | +±0.1  | +1.0 | % FSR  | P              |  |
| MEASURE VOLTAGE                                      |      |        |      |        |                |  |
| Measure Voltage Range                                | -2.0 |        | +6.0 | V      | D              |  |
| Measure Voltage Uncalibrated Accuracy                | -25  | ±2.0   | +25  | mV     | P              | PMU enabled, FVMV, Range B, PE disabled, error at calibration points of 0 V and 5 V, error = $(V_{MEASOUT01} - V_{DUTx})$  |
| Measure Voltage Offset Tempco                        |      | ±10    |      | µV/°C  | C <sub>T</sub> | Measured at calibration points   |
| Measure Voltage Gain Error                           | -2   | ±0.01  | +2   | %      | P              | PMU enabled, FVMV, Range B, PE disabled, gain error from calibration points of 0 V and 5 V   |
| Measure Voltage Gain Tempco                          |      | 25     |      | ppm/°C | C <sub>T</sub> | Measured at calibration points   |
| Measure Voltage INL                                  | -7   | ±1     | +7   | mV     | P              | PMU enabled, FVMV, Range B, PE disabled, after two-point gain/offset calibration; measured over output range of -2.0 V to +6.0 V   |
| Rejection of Measure V vs. $I_{DUTx}$                | -1.5 | ±0.1   | +1.5 | mV     | P              | PMU enabled, FVMV, Range D, PE disabled, force 0 V into load of -10 µA and +10 µA; measure $\Delta V$ reported at MEASOUT01  |

| Parameter  | Min  | Typ       | Max  | Unit     | Test Level     | Conditions/Comments   |  |
|--|------|-----------|------|----------|----------------|---|--|
| <b>MEASOUT01 DC CHARACTERISTICS</b>                |      |           |      |          |                |   |  |
| MEASOUT01 Voltage Range                            | -2.0 |           | +6.0 | V        | D              | PMU enabled, FVMV, PE disabled; source resistance: PMU force 6.0 V and load with 0 mA and 4 mA; sink resistance: PMU force -2.0 V and load with 0 mA and -4 mA; resistance = $\Delta V/\Delta I$ at MEASOUT01 pin |  |
| DC Output Current                                  |      |           | 4    | mA       | D              |   |  |
| MEASOUT01 Pin Output Impedance                     |      | 25        | 200  | $\Omega$ | P              |   |  |
| Output Leakage Current When Tristated              | -1   |           | +1   | $\mu$ A  | P              |   | Tested at -2.0 V and +6.0 V  |
| Output Short-Circuit Current                       | -25  |           | +25  | mA       | P              |   | PMU enabled, FVMV, PE disabled; source: PMU force 6.0 V, short MEASOUT01 to -2.0 V; sink: PMU force -2.0 V, short MEASOUT01 to 6.0 V |
| <b>VOLTAGE CLAMPS</b>                              |      |           |      |          |                |   |  |
| Low Clamp Range (VCL)                              | -2.0 |           | +4.0 | V        | D              | PMU enabled, FIMI, Range A, PE disabled, PMU clamps enabled, VCH = 5 V, VCL = -1 V, PMU force 1 mA and 25 mA into open; $\Delta V$ seen at DUTx pin   |  |
| High Clamp Range (VCH)                             | 0.0  |           | 6.0  | V        | D              |   |  |
| Positive Clamp Voltage Droop                       | -300 | +50       | +300 | mV       | P              |   |  |
| Negative Clamp Voltage Droop                       | -300 | -50       | +300 | mV       | P              | PMU enabled, FIMI, Range A, PE disabled, PMU clamps enabled, VCH = 5 V, VCL = -1 V, PMU force -1 mA and -25 mA into open; $\Delta V$ seen at DUTx pin   |  |
| Uncalibrated Accuracy                              | -250 | $\pm 100$ | +250 | mV       | P              | PMU enabled, FIMI, Range B, PE disabled, PMU damps enabled, PMU force $\pm 1$ mA into open; VCH errors at calibration points of 0 V and 5 V; VCL errors at the calibration points of 0 V and 4 V                  |  |
| INL  | -70  | $\pm 5$   | +70  | mV       | P              | PMU enabled, FIMI, Range B, PE disabled, PMU damps enabled, PMU force $\pm 1$ mA into open; after two-point gain/offset calibration; measured over PMU clamp range  |  |
| DUTGND Voltage Accuracy                            |      | $\pm 1$   |      | mV       | C <sub>T</sub> | Over $\pm 0.1$ V range; measured at end points of PMU clamp functional range  |  |
| <b>SETTLING/SWITCHING TIMES</b>                    |      |           |      |          |                |   |  |
| Voltage Force Settling Time to 0.1% of Final Value |      |           |      |          |                | SCAP = 330 pF, FFCAP = 220 pF<br>PMU enabled, FV, PE disabled, program PMUDAC steps of 500 mV and 5.0 V; simulation of worst case, 2000 pF load, PMUDAC step of 5.0 V   |  |
| Range A, 200 pF and 2000 pF Load                   |      | 15        |      | $\mu$ s  | S              | PMU enabled, FV, PE disabled, start with PMUDAC programmed to 0.0 V, program PMUDAC to 500 mV   |  |
| Range B, 200 pF and 2000 pF Load                   |      | 20        |      | $\mu$ s  | S              |   |  |
| Range C, 200 pF and 2000 pF Load                   |      | 124       |      | $\mu$ s  | S              |   |  |
| Range D, 200 pF and 2000 pF Load                   |      | 1015      |      | $\mu$ s  | S              |   |  |
| Range E, 200 pF and 2000 pF Load                   |      | 3455      |      | $\mu$ s  | S              |   |  |
| Range A, 200 pF and 2000 pF Load                   |      | 8.0       |      | $\mu$ s  | C <sub>B</sub> |   |  |
| Range B, 200 pF and 2000 pF Load                   |      | 8.0       |      | $\mu$ s  | C <sub>B</sub> |   |  |
| Range C, 200 pF and 2000 pF Load                   |      | 8.0       |      | $\mu$ s  | C <sub>B</sub> |   |  |
| Range D, 200 pF Load                               |      | 8.1       |      | $\mu$ s  | C <sub>B</sub> |   |  |
| Range D, 2000 pF Load                              |      | 585       |      | $\mu$ s  | C <sub>B</sub> |   |  |
| Range E, 200 pF Load                               |      | 8.1       |      | $\mu$ s  | C <sub>B</sub> |   |  |
| Range E, 2000 pF Load                              |      | 590       |      | $\mu$ s  | C <sub>B</sub> |   |  |

# ADATE302-02

| Parameter  | Min | Typ    | Max | Unit  | Test Level     | Conditions/Comments   |
|--|-----|--------|-----|-------|----------------|---|
| Voltage Force Settling Time to 1.0% of Final Value |     |        |     |       |                | PMU enabled, FV, PE disabled, start with PMUDAC programmed to 0.0 V, program PMUDAC to 5.0 V  |
| Range A, 200 pF and 2000 pF Load                   |     | 4.2    |     | μs    | C <sub>B</sub> |   |
| Range B, 200 pF Load                               |     | 4.4    |     | μs    | C <sub>B</sub> |   |
| Range B, 2000 pF Load                              |     | 7.6    |     | μs    | C <sub>B</sub> |   |
| Range C, 200 pF Load                               |     | 6.3    |     | μs    | C <sub>B</sub> |   |
| Range C, 2000 pF Load                              |     | 8.1    |     | μs    | C <sub>B</sub> |   |
| Range D, 200 pF Load                               |     | 130    |     | μs    | C <sub>B</sub> |   |
| Range D, 2000 pF Load                              |     | 280    |     | μs    | C <sub>B</sub> |   |
| Range E, 200 pF Load                               |     | 390    |     | μs    | C <sub>B</sub> |   |
| Range E, 2000 pF Load                              |     | 605    |     | μs    | C <sub>B</sub> |   |
| Current Force Settling Time to 0.1% of Final Value |     |        |     |       |                | PMU enabled, FI, PE disabled, start with PMUDAC programmed to 0 current, program PMUDAC to FS current   |
| Range A, 200 pF in Parallel with 120 Ω             |     | 8.2    |     | μs    | S              |   |
| Range B, 200 pF in Parallel with 1.5 kΩ            |     | 9.4    |     | μs    | S              |   |
| Range C, 200 pF in Parallel with 15.0 kΩ           |     | 30     |     | μs    | S              |   |
| Range D, 200 pF in Parallel with 150 kΩ            |     | 281    |     | μs    | S              |   |
| Range E, 200 pF in Parallel with 1.5 MΩ            |     | 2668   |     | μs    | S              |   |
| Current Force Settling Time to 1.0% of Final Value |     |        |     |       |                | PMU enabled, FI, PE disabled, start with PMUDAC programmed to 0 current, program PMUDAC to FS current   |
| Range A, 200 pF in Parallel with 120 Ω             |     | 3.3    |     | μs    | C <sub>B</sub> |   |
| Range B, 200 pF in Parallel with 1.5 kΩ            |     | 4.4    |     | μs    | C <sub>B</sub> |   |
| Range C, 200 pF in Parallel with 15.0 kΩ           |     | 8      |     | μs    | C <sub>B</sub> |   |
| Range D, 200 pF in Parallel with 150 kΩ            |     | 205    |     | μs    | C <sub>B</sub> |   |
| Range E, 200 pF in Parallel with 1.5 MΩ            |     | 505    |     | μs    | C <sub>B</sub> |   |
| INTERACTION AND CROSSTALK                          |     |        |     |       |                |   |
| Measure Voltage Channel-to-Channel Crosstalk       |     | ±0.125 |     | % FSR | C <sub>T</sub> | PMU enabled, FIMV, PE disabled, Range B, forcing 0 mA into 0 V load; other channel: Range A, forcing a step of 0 mA to 25 mA into 0 V load; report ΔV of MEASOUT01 pin under test; 0.125% × 8.0 V = 10 mV |
| Measure Current Channel-to-Channel Crosstalk       |     | ±0.01  |     | % FSR | C <sub>T</sub> |   |

## EXTERNAL SENSE (PMUS\_CHx)

Table 8.

| Parameter             | Min  | Typ | Max  | Unit | Test Level | Conditions/Comments         |
|-----------------------|------|-----|------|------|------------|-----------------------------|
| Voltage Range         | -2.0 |     | +6.0 | V    | D          |                             |
| Input Leakage Current | -20  |     | +20  | nA   | P          | Tested at -2.0 V and +6.0 V |



## DUTGND INPUT

Table 9.

| Parameter                              | Min  | Typ | Max  | Unit | Test Level | Conditions/Comments           |
|--|------|-----|------|------|------------|-------------------------------|
| Input Voltage Range, Referenced to GND | -0.1 |     | +0.1 | V    | D          |                               |
| Input Bias Current                     |      | 1   | 100  | μA   | P          | Tested at -100 mV and +100 mV |

## SERIAL PERIPHERAL INTERFACE

Table 10.

| Parameter                  | Min                   | Typ | Max             | Unit | Test Level     | Conditions/Comments   |
|----------------------------|-----------------------|-----|-----------------|------|----------------|---|
| Serial Input Logic High    | 1.8                   |     | V <sub>CC</sub> | V    | P <sub>F</sub> |   |
| Serial Input Logic Low     | 0                     |     | 0.7             | V    | P <sub>F</sub> |   |
| Input Bias Current         | -10                   | +1  | +10             | μA   | P              | Tested at 0.0 V and 3.3 V   |
| SCLK Clock Rate            |                       | 50  |                 | MHz  | P <sub>F</sub> |   |
| SCLK Pulse Width           |                       | 9   |                 | ns   | C <sub>T</sub> |   |
| SCLK Crosstalk on DUTx Pin |                       | 8   |                 | mV   | C <sub>B</sub> | PE disabled, PMU FV enabled and forcing 0 V   |
| Serial Output Logic High   | V <sub>CC</sub> - 0.4 |     | V <sub>CC</sub> | V    | P <sub>F</sub> | Sourcing 2 mA   |
| Serial Output Logic Low    | 0                     |     | 0.8             | V    | P <sub>F</sub> | Sinking 2 mA  |
| Update Time                |                       | 10  |                 | μs   | D              | Maximum delay time required for the part to enter a stable state after a serial bus command is loaded |

## HVOUT DRIVER

Table 11.

| Parameter                        | Min  | Typ  | Max                      | Unit  | Test Level     | Conditions/Comments   |
|----------------------------------|------|------|--------------------------|-------|----------------|---|
| VHH BUFFER                       |      |      |                          |       |                | VHH = (VT + 1 V) × 2 + DUTGND   |
| Voltage Range                    | 5.9  |      | V <sub>PLUS</sub> - 3.25 | V     | D              | V <sub>PLUS</sub> = 16.75 V nominal; in this condition, V <sub>HVOUT</sub> maximum = 13.5 V   |
| Output High                      | 13.5 |      |                          | V     | P              | VHH mode enabled, RCVx pins active, VHH level = full scale, sourcing 15 mA  |
| Output Low                       |      |      | 5.9                      | V     | P              | VHH mode enabled, RCVx pins active, VHH level = zero scale, sinking 15 mA   |
| Accuracy Uncalibrated            | -500 | ±100 | +500                     | mV    | P              | VHH mode enabled, RCVx pins active, V <sub>HVOUT</sub> error measured at calibration points of 7 V and 12 V   |
| Offset Tempco                    |      | 1    |                          | mV/°C | C <sub>T</sub> | Measured at calibration points  |
| Resolution                       |      | 1.21 | 1.5                      | mV    | P <sub>F</sub> | VHH mode enabled, RCVx pins active, after two-point gain/offset calibration; range/number of DAC bits as measured at calibration points of 7 V and 12 V       |
| INL                              | -30  | ±15  | +30                      | mV    | P              | VHH mode enabled, RCVx pins active, after two-point gain/offset calibration; measured over VHH range of 5.9 V to 13.5 V                                       |
| DUTGND Voltage Accuracy          |      | ±1   |                          | mV    | C <sub>T</sub> | Over ±0.1 V range; measured at end points of VHH functional range   |
| Output Resistance                |      | 1    | 10                       | Ω     | P              | VHH mode enabled, RCVx pins active, source: VHH = 10.0 V, I <sub>HVOUT</sub> = 0 mA and 15 mA; sink: VHH = 6.5 V, I <sub>HVOUT</sub> = 0 mA and -15 mA; ΔV/ΔI |
| DC Output Current Limit Source   | 60   |      | 100                      | mA    | P              | VHH mode enabled, RCVx pins active, VHH = 10.0 V, short HVOUT pin to 5.9 V, measure current   |
| DC Output Current Limit Sink     | -100 |      | -60                      | mA    | P              | VHH mode enabled, RCVx pins active, VHH = 6.5 V, short HVOUT pin to 14.1 V, measure current   |
| Rise Time (From VL or VH to VHH) |      | 175  |                          | ns    | C <sub>B</sub> | VHH mode enabled, toggle RCVx pins, VHH = 13.5 V, VL = VH = 3.0 V; 20% to 80%, for DATAx high and DATAx low   |

# ADATE302-02

| Parameter                           | Min  | Typ  | Max  | Unit  | Test Level     | Conditions/Comments   |
|-------------------------------------|------|------|------|-------|----------------|---|
| Fall Time (From VHH to VL or VH)    |      | 23   |      | ns    | C <sub>B</sub> | VHH mode enabled, toggle RCVx pins, VHH = 13.5 V, VL = VH = 3.0 V; 20% to 80%, for DATAx high and DATAx low   |
| Preshoot, Overshoot, and Undershoot |      | ±100 |      | mV    | C <sub>B</sub> | VHH mode enabled, toggle RCVx pins, VHH = 13.5 V, VL = VH = 3.0 V; for DATAx high and DATAx low   |
| <b>VL/VH BUFFER</b>                 |      |      |      |       |                |   |
| Voltage Range                       | -0.1 |      | +6.0 | V     | D              |   |
| Accuracy Uncalibrated               | -500 | ±100 | +500 | mV    | P              | VHH mode enabled, RCVx pins inactive, error measured at calibration points of 0 V and 5 V   |
| Offset Tempco                       |      | 1    |      | mV/°C | C <sub>T</sub> | Measured at calibration points  |
| Resolution                          |      | 0.61 | 0.75 | mV    | P <sub>F</sub> | VHH mode enabled, RCVx pins inactive, after two-point gain/offset calibration; range/number of DAC bits as measured at calibration points of 0 V and 5 V      |
| INL                                 | -20  | ±4   | +20  | mV    | P              | VHH mode enabled, RCVx pins inactive, after two-point gain/offset calibration; measured over range of -0.1 V to +6.0 V  |
| DUTGND Voltage Accuracy             |      | ±2   |      | mV    | C <sub>T</sub> | Over ±0.1 V range; measured at end points of VH and VL, functional range  |
| Output Resistance                   | 46   | 48   | 50   | Ω     | P              | VHH mode enabled, RCVx pins inactive, source: VH = 3.0 V, I <sub>HVOUT</sub> = 1 mA and 50 mA; sink: VL = 2.0 V, I <sub>HVOUT</sub> = -1 mA and -50 mA; ΔV/ΔI |
| DC Output Current Limit Source      | 60   |      | 100  | mA    | P              | VHH mode enabled, RCVx pins inactive, VH = 6.0 V, short HVOUT pin to -0.1 V, DATAx high, measure current  |
| DC Output Current Limit Sink        | -100 |      | -60  | mA    | P              | VHH mode enabled, RCVx pins inactive, VL = -0.1 V, short HVOUT pin to 6.0 V, DATAx low, measure current   |
| Rise Time (VL to VH)                |      | 10.0 |      | ns    | C <sub>B</sub> | VHH mode enabled, RCVx pins inactive, VL = 0.0 V, VH = 3.0 V, toggle DATAx pins; 20% to 80%   |
| Fall Time (VH to VL)                |      | 11.3 |      | ns    | C <sub>B</sub> | VHH mode enabled, RCVx pins inactive, VL = 0.0 V, VH = 3.0 V, toggle DATAx pins; 20% to 80%   |
| Preshoot, Overshoot, and Undershoot |      | ±54  |      | mV    | C <sub>B</sub> | VHH mode enabled, RCV inactive, VL = 0.0 V, VH = 3.0 V, toggle DATAx pins   |

## OVERVOLTAGE DETECTOR (OVD)

Table 12.

| Parameter                           | Min  | Typ | Max  | Unit | Test Level     | Conditions/Comments  |
|-------------------------------------|------|-----|------|------|----------------|--|
| <b>DC CHARACTERISTICS</b>           |      |     |      |      |                |  |
| Programmable Voltage Range          | -3.0 |     | +7.0 | V    | D              |  |
| Accuracy Uncalibrated               | -200 |     | +200 | mV   | P              | OVD offset errors measured at programmed levels of 7.0 V and -3.0 V  |
| Hysteresis                          |      | 112 |      | mV   | C <sub>B</sub> |  |
| <b>LOGIC OUTPUT CHARACTERISTICS</b> |      |     |      |      |                |  |
| Off State Leakage                   |      | 10  | 1000 | nA   | P              | Disable OVD alarm, apply 3.3 V to OVD_CHx pin, measure leakage current   |
| Maximum On Voltage @100 μA          |      | 0.2 | 0.7  | V    | P              | Activate alarm, force 100 μA into OVD_CHx, measure active alarm voltage  |
| Propagation Delay                   |      | 1.8 |      | μs   | C <sub>B</sub> | For OVD high: DUTx = 0 V to 6 V swing, OVD_CHx high = 3.0 V, OVD_CHx low = -3.0 V; for OVD_CHx low: DUTx = 0 V to 6 V swing, OVD_CHx high = 7.0 V, OVD_CHx low = 3.0 V |

**16-BIT DAC MONITOR MUX**

**Table 13.**

| <b>Parameter</b>           | <b>Min</b> | <b>Typ</b> | <b>Max</b> | <b>Unit</b> | <b>Test Level</b> | <b>Conditions/Comments</b>                  |
|----------------------------|------------|------------|------------|-------------|-------------------|---|
| DC CHARACTERISTICS         |            |            |            |             |                   |   |
| Programmable Voltage Range | -2.5       |            | +7.5       | V           | D                 | PMUDAC = 0.0 V, FV, I = 0 μA, 200 μA; ΔV/ΔI |
| Output Resistance          |            | 16         |            | kΩ          | C <sub>T</sub>    |   |

## ABSOLUTE MAXIMUM RATINGS

Table 14.

| Parameter   | Rating               |
|---|----------------------|
| Supply Voltages                                     |                      |
| Positive Supply Voltage ( $V_{DD}$ to GND)          | -0.5 V to +11.0 V    |
| Positive $V_{CC}$ Supply Voltage ( $V_{CC}$ to GND) | -0.5 V to +4.0 V     |
| Negative Supply Voltage ( $V_{SS}$ to GND)          | -6.25 V to +0.5 V    |
| Supply Voltage Difference ( $V_{DD}$ to $V_{SS}$ )  | -1.0 V to +16.5 V    |
| Reference Ground (DUTGND to GND)                    | -0.5 V to +0.5 V     |
| AGND to DGND  | -0.5 V to +0.5 V     |
| VPLUS Supply Voltage ( $V_{PLUS}$ to GND)           | -0.5 V to +17.5 V    |
| Input Voltages                                      |                      |
| Input Common-Mode Voltage                           | $V_{SS}$ to $V_{DD}$ |
| Short-Circuit Voltage <sup>1</sup>                  | -3.0 V to +8.0 V     |
| High Speed Input Voltage <sup>2</sup>               | 0 to $V_{CC}$        |
| High Speed Differential Input Voltage <sup>3</sup>  | 0 to $V_{CC}$        |
| VREF  | -0.5 V to +5.5 V     |
| DUTx I/O Pin Current                                |                      |
| DCL Maximum Short-Circuit Current <sup>4</sup>      | ±140 mA              |
| Temperature   |                      |
| Operating Temperature, Junction                     | 125°C                |
| Storage Temperature Range                           | -65°C to +150°C      |

<sup>1</sup>  $R_L = 0 \Omega$ ,  $V_{DUTx}$  continuous short-circuit condition (VH, VL, VT, high-Z, VCOM, clamp modes).

<sup>2</sup> DATAxP, DATAxN, RCVxP, RCVxN, under source  $R = 0 \Omega$ .

<sup>3</sup> DATAxP to DATAxN, RCVxP, RCVxN.

<sup>4</sup>  $R_L = 0 \Omega$ ,  $V_{DUTx} = -3 V$  to +8 V; DCL current limit. Continuous short-circuit condition. ADATE302-02 must current limit and survive continuous short circuit.

Stresses above those listed under Absolute Maximum Ratings may cause permanent damage to the device. This is a stress rating only; functional operation of the device at these or any other conditions above those indicated in the operational section of this specification is not implied. Exposure to absolute maximum rating conditions for extended periods may affect device reliability.

## THERMAL RESISTANCE

Table 15. Thermal Resistance

| Package Type    | $\theta_{JA}$ | $\theta_{JC}$ | Unit |
|-----------------|---------------|---------------|------|
| 84-Ball CSP_BGA | 31.1          | 0.51          | °C/W |

## EXPLANATION OF TEST LEVELS

|                |   |
|----------------|---|
| D              | Definition                                  |
| S              | Design verification simulation              |
| P              | 100% production tested                      |
| P <sub>F</sub> | Functionally checked during production test |
| C <sub>T</sub> | Characterized on tester                     |
| C <sub>B</sub> | Characterized on bench                      |

## ESD CAUTION



**ESD (electrostatic discharge) sensitive device.** Charged devices and circuit boards can discharge without detection. Although this product features patented or proprietary protection circuitry, damage may occur on devices subjected to high energy ESD. Therefore, proper ESD precautions should be taken to avoid performance degradation or loss of functionality.

## PIN CONFIGURATIONS AND FUNCTION DESCRIPTIONS

|   | 10        | 9         | 8              | 7    | 6              | 5              | 4         | 3              | 2         | 1                   |
|---|-----------|-----------|----------------|------|----------------|----------------|-----------|----------------|-----------|---------------------|
| A | HVOUT     | PMUS_CH0  | VSSO_0 (DRIVE) | DUT0 | VDDO_0 (DRIVE) | VDDO_1 (DRIVE) | DUT1      | VSSO_1 (DRIVE) | PMUS_CH1  | TEMPSENSE           |
| B | VPLUS     | SCAP0     | VSS            | AGND | VDD            | VDD            | AGND      | VSS            | SCAP1     | VDD/VDD_TMPSENS     |
| C | FFCAP_0B  | AGND      | DATA0N         | VSS  | VDD            | VDD            | VSS       | DATA1N         | AGND      | FFCAP_1B            |
| D | OVD_CH0   | VDD       | DATA0P         |      |                |                |           | DATA1P         | VDD       | OVD_CH1             |
| E | FFCAP_0A  | VSS       | RCV0N          |      |                |                |           | RCV1N          | VSS       | FFCAP_1A            |
| F | AGND      | AGND      | RCV0P          |      |                |                |           | RCV1P          | AGND      | AGND                |
| G | COMP_QL0P | COMP_QL0N | COMP_VTT0      |      |                |                |           | COMP_VTT1      | COMP_QL1N | COMP_QL1P           |
| H | COMP_QH0P | COMP_QH0N | AGND           | VSS  | VDD            | VDD            | VSS       | AGND           | COMP_QH1N | COMP_QH1P           |
| J | AGND      | AGND      | AGND           | RST  | SDIN           | DGND           | DAC16_MON | AGND           | AGND      | AGND                |
| K | VREF_GND  | VREF      | AGND           | VCC  | SCLK           | SDOUT          | CS        | AGND           | DUTGND    | MEASOUT01/TEMPSENSE |

0779-002

Figure 2. 84-Ball BGA Pin Configuration, Bottom Side (BGA Balls Are Visible)

Table 16. Pin Function Descriptions

| BGA Designator | Mnemonic        | Description   |
|----------------|-----------------|---|
| A1             | TEMPSENSE       | Temperature Sense Output                              |
| A2             | PMUS_CH1        | PMU External Sense Path Channel 1                     |
| A3             | VSSO_1 (Drive)  | Driver Output Supply -5.75 V Channel 1                |
| A4             | DUT1            | Device Under Test Channel 1                           |
| A5             | VDDO_1 (Drive)  | Driver Output Supply +10.0 V Channel 1                |
| A6             | VDDO_0 (Drive)  | Driver Output Supply +10.0 V Channel 0                |
| A7             | DUT0            | Device Under Test Channel 0                           |
| A8             | VSSO_0 (Drive)  | Driver Output Supply -5.75 V Channel 0                |
| A9             | PMUS_CH0        | PMU External Sense Path Channel 0                     |
| A10            | HVOUT           | High Voltage Driver Output                            |
| B1             | VDD/VDD_TMPSENS | Temperature Sense Supply +10.0 V                      |
| B2             | SCAP1           | PMU Stability Capacitor Connection Channel 1 (330 pF) |

# ADATE302-02

| BGA Designator | Mnemonic  | Description   |
|----------------|-----------|---|
| B3             | VSS       | Supply –5.75 V  |
| B4             | AGND      | Analog Ground   |
| B5             | VDD       | Supply +10.0 V  |
| B6             | VDD       | Supply +10.0 V  |
| B7             | AGND      | Analog Ground   |
| B8             | VSS       | Supply –5.75 V  |
| B9             | SCAP0     | PMU Stability Capacitor Connection Channel 0 (330 pF)     |
| B10            | VPLUS     | Supply +16.75 V   |
| C1             | FFCAP_1B  | PMU Feedforward Capacitor Connection B Channel 1 (220 pF) |
| C2             | AGND      | Analog Ground   |
| C3             | DATA1N    | Driver Data Input (Negative) Channel 1                    |
| C4             | VSS       | Supply –5.75 V  |
| C5             | VDD       | Supply +10.0 V  |
| C6             | VDD       | Supply +10.0 V  |
| C7             | VSS       | Supply –5.75 V  |
| C8             | DATA0N    | Driver Data Input (Negative) Channel 0                    |
| C9             | AGND      | Analog Ground   |
| C10            | FFCAP_0B  | PMU Feedforward Capacitor Connection B Channel 0 (220 pF) |
| D1             | OVD_CH1   | Overvoltage Detection Flag Output Channel 1               |
| D2             | VDD       | Supply +10.0 V  |
| D3             | DATA1P    | Driver Data Input (Positive) Channel 1                    |
| D8             | DATA0P    | Driver Data Input (Positive) Channel 0                    |
| D9             | VDD       | Supply +10.0 V  |
| D10            | OVD_CH0   | Overvoltage Detection Flag Output Channel 0               |
| E1             | FFCAP_1A  | PMU Feedforward Capacitor Connection A Channel 1 (220 pF) |
| E2             | VSS       | Supply –5.75 V  |
| E3             | RCV1N     | Receive Data Input (Negative) Channel 1                   |
| E8             | RCV0N     | Receive Data Input (Negative) Channel 0                   |
| E9             | VSS       | Supply –5.75 V  |
| E10            | FFCAP_0A  | PMU Feedforward Capacitor Connection A Channel 0 (220 pF) |
| F1             | AGND      | Analog Ground   |
| F2             | AGND      | Analog Ground   |
| F3             | RCV1P     | Receive Data Input (Positive) Channel 1                   |
| F8             | RCV0P     | Receive Data Input (Positive) Channel 0                   |
| F9             | AGND      | Analog Ground   |
| F10            | AGND      | Analog Ground   |
| G1             | COMP_QL1P | Low-Side Comparator Output (Positive) Channel 1           |
| G2             | COMP_QL1N | Low-Side Comparator Output (Negative) Channel 1           |
| G3             | COMP_VTT1 | Comparator Supply Termination Channel 1                   |
| G8             | COMP_VTT0 | Comparator Supply Termination Channel 0                   |
| G9             | COMP_QL0N | Low-Side Comparator Output (Negative) Channel 0           |
| G10            | COMP_QL0P | Low-Side Comparator Output (Positive) Channel 0           |
| H1             | COMP_QH1P | High-Side Comparator Output (Positive) Channel 1          |
| H2             | COMP_QH1N | High-Side Comparator Output (Negative) Channel 1          |
| H3             | AGND      | Analog Ground   |
| H4             | VSS       | Supply –5.75 V  |
| H5             | VDD       | Supply +10.0 V  |
| H6             | VDD       | Supply +10.0 V  |
| H7             | VSS       | Supply –5.75 V  |
| H8             | AGND      | Analog Ground   |

| <b>BGA Designator</b> | <b>Mnemonic</b>     | <b>Description</b>   |
|-----------------------|---------------------|--|
| H9                    | COMP_QH0N           | High-Side Comparator Output (Negative) Channel 0   |
| H10                   | COMP_QH0P           | High-Side Comparator Output (Positive) Channel 0   |
| J1                    | AGND                | Analog Ground  |
| J2                    | AGND                | Analog Ground  |
| J3                    | AGND                | Analog Ground  |
| J4                    | DAC16_MON           | 16-Bit DAC Monitor Mux Output  |
| J5                    | DGND                | Digital Ground   |
| J6                    | SDIN                | Serial Peripheral Interface (SPI) Data In  |
| J7                    | RST                 | Serial Peripheral Interface (SPI) Reset  |
| J8                    | AGND                | Analog Ground  |
| J9                    | AGND                | Analog Ground  |
| J10                   | AGND                | Analog Ground  |
| K1                    | MEASOUT01/TEMPSENSE | Muxed Output Shared by PMU MEASOUT Channel 0, PMU MEASOUT Channel 1, Temperature Sense and Temperature Sense GND Reference |
| K2                    | DUTGND              | DUT Ground Reference   |
| K3                    | AGND                | Analog Ground  |
| K4                    | CS                  | Serial Peripheral Interface (SPI) Chip Select  |
| K5                    | SDOUT               | Serial Peripheral Interface (SPI) Data Out   |
| K6                    | SCLK                | Serial Peripheral Interface (SPI) Clock  |
| K7                    | VCC                 | Supply +3.3 V  |
| K8                    | AGND                | Analog Ground  |
| K9                    | VREF                | +5 V DAC Reference Voltage   |
| K10                   | VREF_GND            | DAC Ground Reference   |

# ADATE302-02

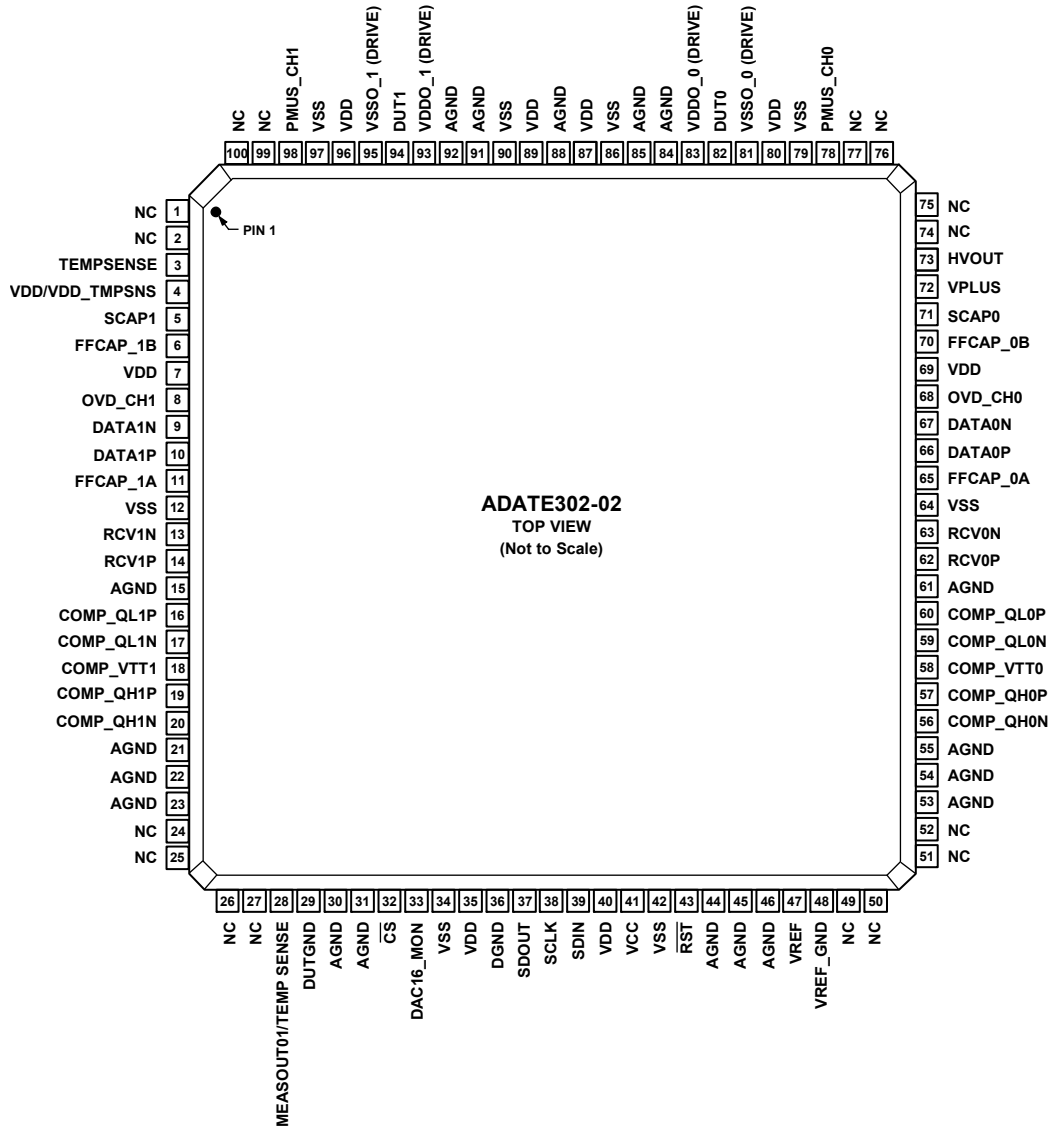

- NOTES**  
 1. NC = NO CONNECT.  
 2. EXPOSED PAD IS CONNEC TED TO V<sub>SS</sub>.

Figure 3. 100-Lead TQFP\_EP Pin Configuration

Table 17. Pin Function Descriptions

| Pin No. | Mnemonic       | Description   |
|---------|----------------|---|
| 1       | NC             | No Connect. No physical connection to die.                  |
| 2       | NC             | No Connect. No physical connection to die.                  |
| 3       | TEMPSENSE      | Temperature Sense Output.                                   |
| 4       | VDD/VDD_TMPSNS | Temperature Sense Supply +10.0 V.                           |
| 5       | SCAP1          | PMU Stability Capacitor Connection Channel 1 (330 pF).      |
| 6       | FFCAP_1B       | PMU Feed Forward Capacitor Connection B Channel 1 (220 pF). |
| 7       | VDD            | Supply +10.0 V.   |
| 8       | OVD_CH1        | Overvoltage Detection Flag Output Channel 1.                |
| 9       | DATA1N         | Driver Data Input (Negative) Channel 1.                     |
| 10      | DATA1P         | Driver Data Input (Positive) Channel 1.                     |
| 11      | FFCAP_1A       | PMU Feedforward Capacitor Connection A Channel 1 (220 pF).  |
| 12      | VSS            | Supply -5.75 V.   |



| Pin No. | Mnemonic             | Description  |
|---------|----------------------|--|
| 13      | RCV1N                | Receive Data Input (Negative) Channel 1.   |
| 14      | RCV1P                | Receive Data Input (Positive) Channel 1.   |
| 15      | AGND                 | Analog Ground.   |
| 16      | COMP_QL1P            | Low-Side Comparator Output (Positive) Channel 1.   |
| 17      | COMP_QL1N            | Low-Side Comparator Output (Negative) Channel 1.   |
| 18      | COMP_VTT1            | Comparator Supply Channel 1.   |
| 19      | COMP_QH1P            | High-Side Comparator Output (Positive) Channel 1.  |
| 20      | COMP_QH1N            | High-Side Comparator Output (Negative) Channel 1.  |
| 21      | AGND                 | Analog Ground.   |
| 22      | AGND                 | Analog Ground.   |
| 23      | AGND                 | Analog Ground.   |
| 24      | NC                   | No Connect. No physical connection to die.   |
| 25      | NC                   | No Connect. No physical connection to die.   |
| 26      | NC                   | No Connect. No physical connection to die.   |
| 27      | NC                   | No Connect. No physical connection to die.   |
| 28      | MEASOUT01/TEMP SENSE | Shared Muxed Output. Muxed output shared by PMU MEASOUT Channel 0, PMU MEASOUT Channel 1, and the temperature sense and temperature sense GND reference. |
| 29      | DUTGND               | Device Under Test Ground Reference.  |
| 30      | AGND                 | Analog Ground.   |
| 31      | AGND                 | Analog Ground.   |
| 32      | $\overline{CS}$      | Serial Peripheral Interface (SPI®) Chip Select.  |
| 33      | DAC16_MON            | 16-Bit DAC Monitor Mux Output.   |
| 34      | VSS                  | Supply -5.75 V.  |
| 35      | VDD                  | Supply +10.0 V.  |
| 36      | DGND                 | Digital Ground.  |
| 37      | SDOUT                | Serial Programmable Interface (SPI) Data Output.   |
| 38      | SCLK                 | Serial Programmable Interface (SPI) Clock.   |
| 39      | SDIN                 | Serial Programmable Interface (SPI) Data Input.  |
| 40      | VDD                  | Supply +10.0 V.  |
| 41      | VCC                  | Supply +3.3 V.   |
| 42      | $\overline{VSS}$     | Supply -5.75 V.  |
| 43      | RST                  | Serial Peripheral Interface (SPI) Reset.   |
| 44      | AGND                 | Analog Ground.   |
| 45      | AGND                 | Analog Ground.   |
| 46      | AGND                 | Analog Ground.   |
| 47      | VREF                 | +5 V DAC Reference Voltage.  |
| 48      | VREF_GND             | DAC Ground Reference.  |
| 49      | NC                   | No Connect. No physical connection to die.   |
| 50      | NC                   | No Connect. No physical connection to die.   |
| 51      | NC                   | No Connect. No physical connection to die.   |
| 52      | NC                   | No Connect. No physical connection to die.   |
| 53      | AGND                 | Analog Ground.   |
| 54      | AGND                 | Analog Ground.   |
| 55      | AGND                 | Analog Ground.   |
| 56      | Comp_QH0N            | High-Side Comparator Output (Negative) Channel 0.  |
| 57      | Comp_QH0P            | High-Side Comparator Output (Positive) Channel 0.  |
| 58      | Comp_VTT0            | Comparator Supply Channel 0.   |
| 59      | Comp_QL0N            | Low-Side Comparator Output (Negative) Channel 0.   |
| 60      | Comp_QL0P            | Low-Side Comparator Output (Positive) Channel 0.   |

# ADATE302-02

| Pin No. | Mnemonic       | Description  |
|---------|----------------|--|
| 61      | AGND           | Analog Ground.   |
| 62      | RCV0P          | Receive Data Input (Positive) Channel 0.                       |
| 63      | RCV0N          | Receive Data Input (Negative) Channel 0.                       |
| 64      | VSS            | Supply -5.75 V.  |
| 65      | FFCAP_0A       | PMU Feedforward Capacitor Connection A Channel 0 (220 pF).     |
| 66      | DATA0P         | Driver Data Input (Positive) Channel 0.                        |
| 67      | DATA0N         | Driver Data Input (Negative) Channel 0.                        |
| 68      | OVD_CH0        | Overvoltage Detection Flag Output Channel 0.                   |
| 69      | VDD            | Supply +10.0 V.  |
| 70      | FFCAP_0B       | PMU Feedforward Capacitor Connection B Channel 0 (220 pF).     |
| 71      | SCAP0          | PMU Stability Capacitor Connection Channel 0 (330 pF).         |
| 72      | VPLUS          | Supply +16.75 V.   |
| 73      | HVOUT          | High Voltage Driver Output.                                    |
| 74      | NC             | No Connect. No physical connection to die.                     |
| 75      | NC             | No Connect. No physical connection to die.                     |
| 76      | NC             | No Connect. No physical connection to die.                     |
| 77      | NC             | No Connect. No physical connection to die.                     |
| 78      | PMUS_CH0       | PMU External Sense Path Channel 0.                             |
| 79      | VSS            | Supply -5.75 V.  |
| 80      | VDD            | Supply +10.0 V.  |
| 81      | VSSO_0 (DRIVE) | Driver Output Supply -5.75 V Channel 0.                        |
| 82      | DUT0           | Device Under Test Channel 0.                                   |
| 83      | VDDO_0 (DRIVE) | Driver Output Supply +10.0 V Channel 0.                        |
| 84      | AGND           | Analog Ground.   |
| 85      | AGND           | Analog Ground.   |
| 86      | VSS            | Supply -5.75 V.  |
| 87      | VDD            | Supply +10.0 V.  |
| 88      | AGND           | Analog Ground.   |
| 89      | VDD            | Supply +10.0 V.  |
| 90      | VSS            | Supply -5.75 V.  |
| 91      | AGND           | Analog Ground.   |
| 92      | AGND           | Analog Ground.   |
| 93      | VDDO_1 (DRIVE) | Driver Output Supply +10.0 V Channel 1.                        |
| 94      | DUT1           | Device Under Test Channel 1.                                   |
| 95      | VSSO_1 (DRIVE) | Driver Output Supply -5.75 V Channel 1.                        |
| 96      | VDD            | Supply +10.0 V.  |
| 97      | VSS            | Supply -5.75 V.  |
| 98      | PMUS_CH1       | PMU External Sense Path Channel 1.                             |
| 99      | NC             | No Connect. No physical connection to die.                     |
| 100     | NC             | No Connect. No physical connection to die.                     |
| EP      |                | Exposed Pad. The exposed pad is connected to V <sub>SS</sub> . |

# TYPICAL PERFORMANCE CHARACTERISTICS

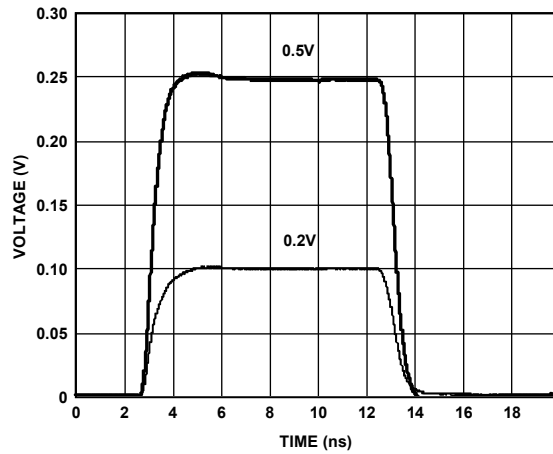

Figure 4. Driver Small Signal Response;  $V_H = 0.2\text{ V}, 0.5\text{ V}; V_L = 0.0\text{ V}; 50\ \Omega$  Termination

07278-080

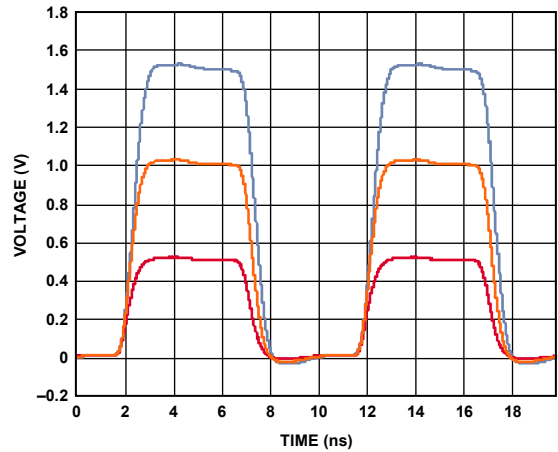

Figure 7. 100 MHz Driver Response;  $V_H = 1.0\text{ V}, 2.0\text{ V}, 3.0\text{ V}; V_L = 0.0\text{ V}; 50\ \Omega$  Termination

07278-085

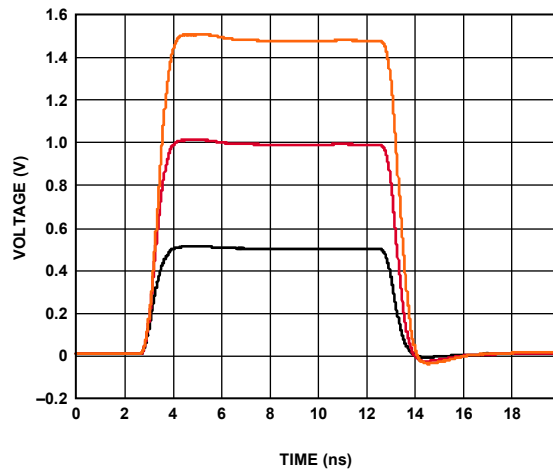

Figure 5. Driver Large Signal Response;  $V_H = 1.0\text{ V}, 2.0\text{ V}, 3.0\text{ V}; V_L = 0.0\text{ V}; 50\ \Omega$  Termination

07278-079

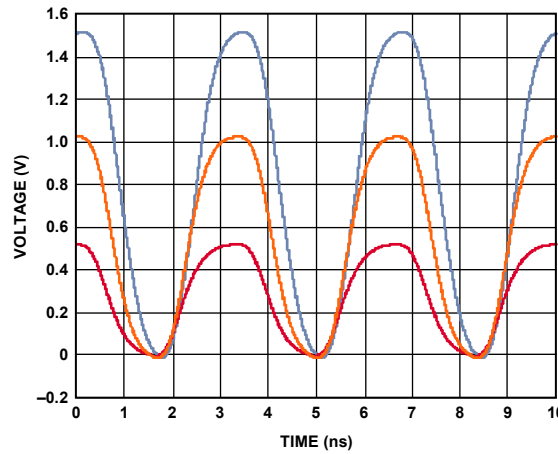

Figure 8. 300 MHz Driver Response;  $V_H = 1.0\text{ V}, 2.0\text{ V}, 3.0\text{ V}; V_L = 0.0\text{ V}; 50\ \Omega$  Termination

07278-084

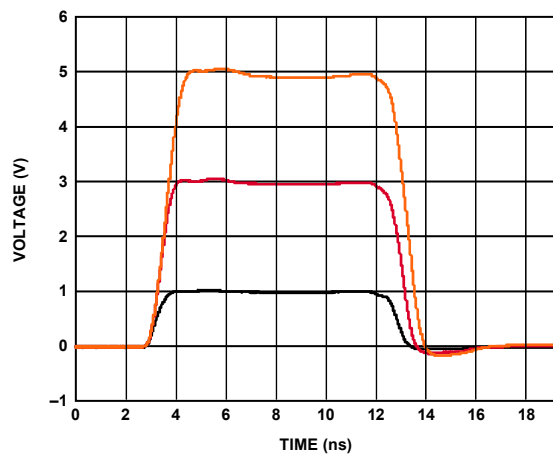

Figure 6. Driver Large Signal Response;  $V_H = 1.0\text{ V}, 3.0\text{ V}, 5.0\text{ V}; V_L = 0.0\text{ V}; 500\ \Omega$  Termination

07278-078

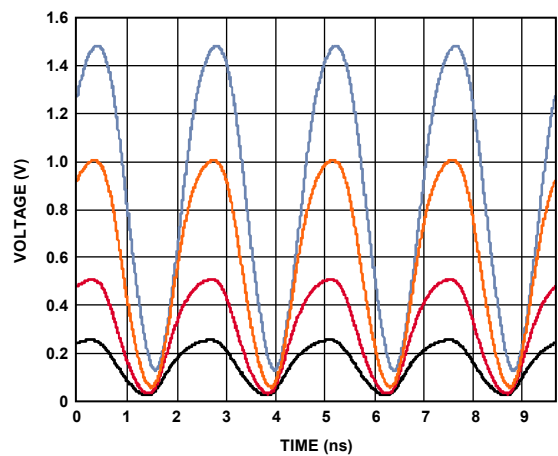

Figure 9. 400 MHz Driver Response;  $V_H = 0.5\text{ V}, 1.0\text{ V}, 2.0\text{ V}, 3.0\text{ V}; V_L = 0.0\text{ V}; 50\ \Omega$  Termination

07278-083

# ADATE302-02

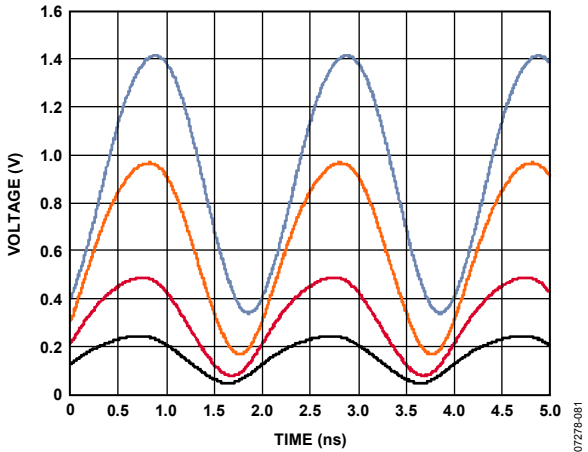

Figure 10. 500 MHz Driver Response;  $V_H = 0.5\text{ V}, 1.0\text{ V}, 2.0\text{ V}, 3.0\text{ V}; V_L = 0.0\text{ V}; 50\ \Omega$  Termination

07278-081

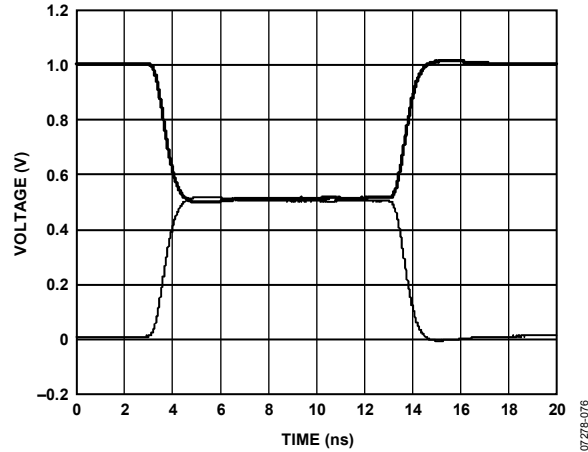

Figure 13. Driver Active ( $V_H/V_L$ ) to/from  $V_{TERM}$  Transition;  $V_H = 2.0\text{ V}; V_T = 1.0\text{ V}; V_L = 0.0\text{ V}$

07278-076

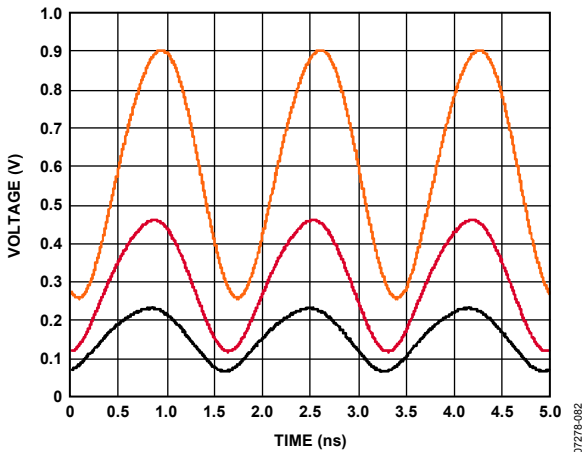

Figure 11. 600 MHz Driver Response;  $V_H = 0.5\text{ V}, 1.0\text{ V}, 2.0\text{ V}; V_L = 0.0\text{ V}; 50\ \Omega$  Termination

07278-082

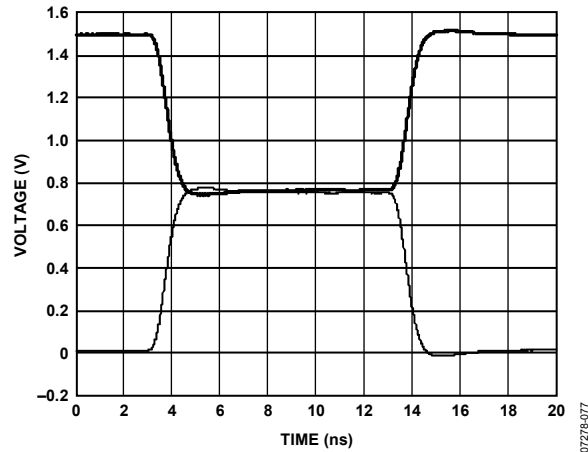

Figure 14. Driver Active ( $V_H/V_L$ ) to/from  $V_{TERM}$  Transition;  $V_H = 3.0\text{ V}; V_T = 1.5\text{ V}; V_L = 0.0\text{ V}$

07278-077

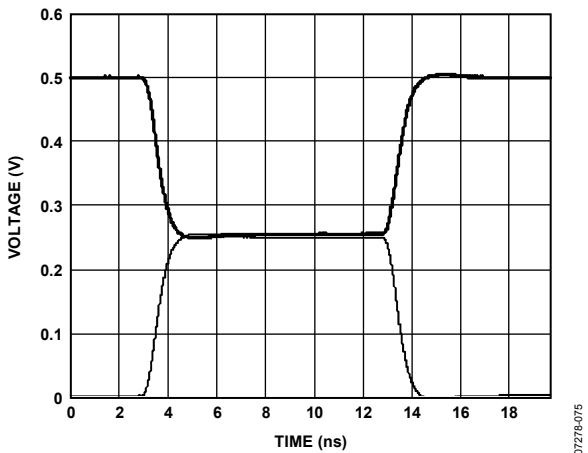

Figure 12. Driver Active ( $V_H/V_L$ ) to/from  $V_{TERM}$  Transition;  $V_H = 1.0\text{ V}; V_T = 0.5\text{ V}; V_L = 0.0\text{ V}$

07278-075

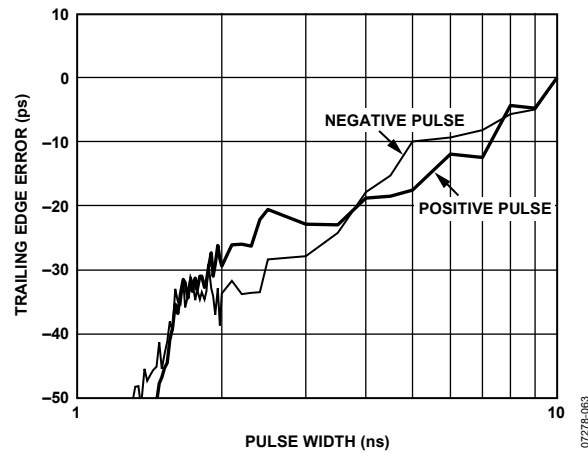

Figure 15. Driver Minimum Pulse Width;  $V_H = 0.2\text{ V}; V_L = 0.0\text{ V}$

07278-063

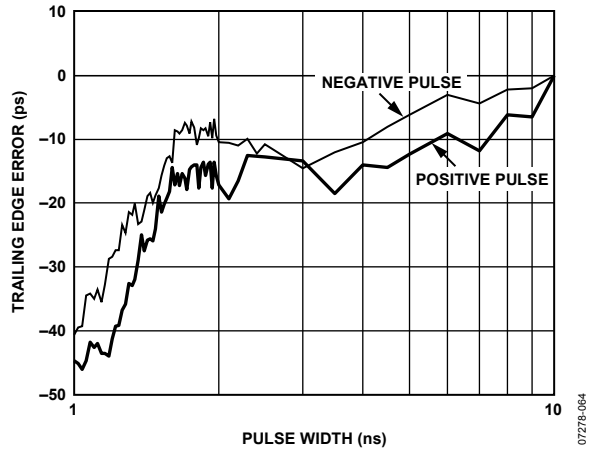

Figure 16. Driver Minimum Pulse Width;  
VH = 0.5 V; VL = 0.0 V

07278-064

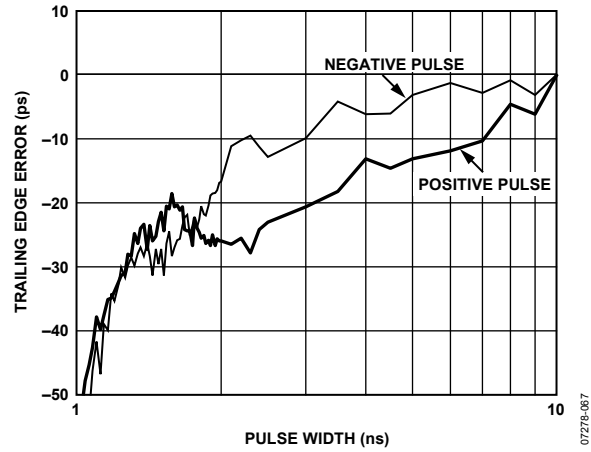

Figure 19. Driver Minimum Pulse Width;  
VH = 3.0 V; VL = 0.0 V

07278-067

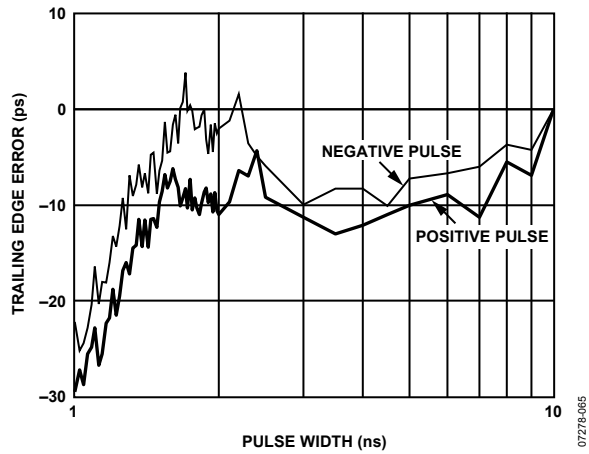

Figure 17. Driver Minimum Pulse Width;  
VH = 1.0 V; VL = 0.0 V

07278-065

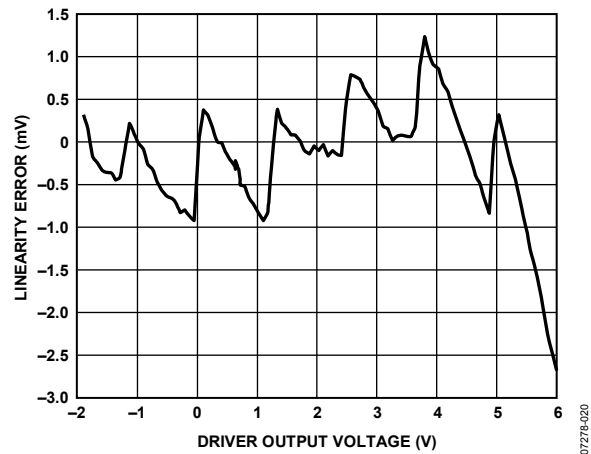

Figure 20. Driver VH Linearity Error

07278-020

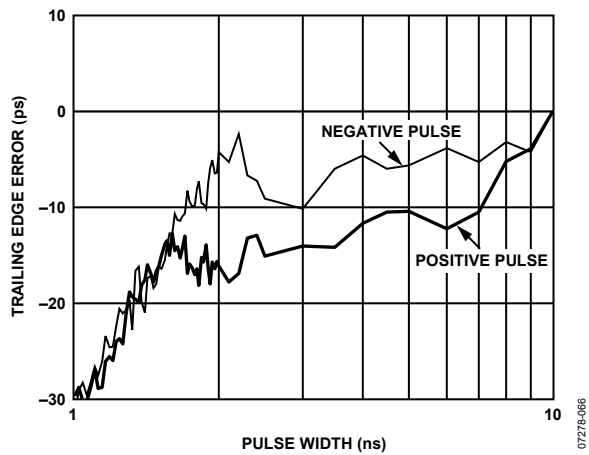

Figure 18. Driver Minimum Pulse Width;  
VH = 2.0 V; VL = 0.0 V

07278-066

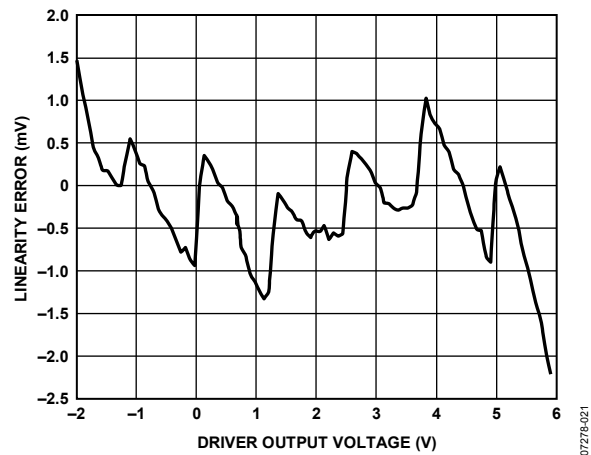

Figure 21. Driver VL Linearity Error

07278-021

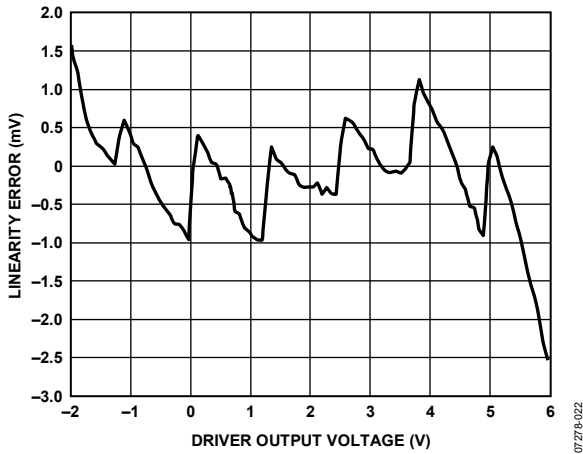

Figure 22. Driver VT Linearity Error

07278-022

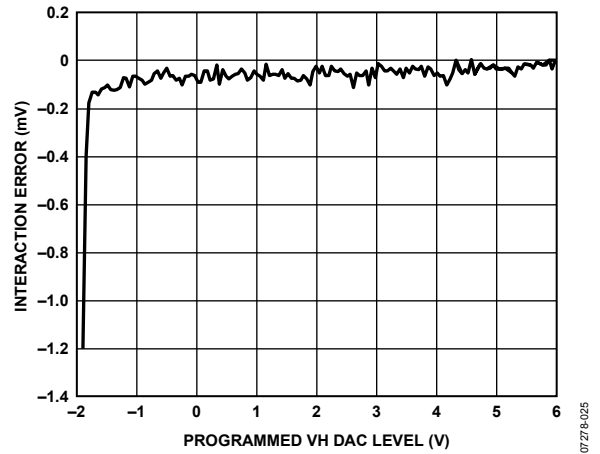

Figure 25. Driver Interaction Error;  
VL = -2.0 V; VH Swept from -1.9 V to +6.0 V

07278-025

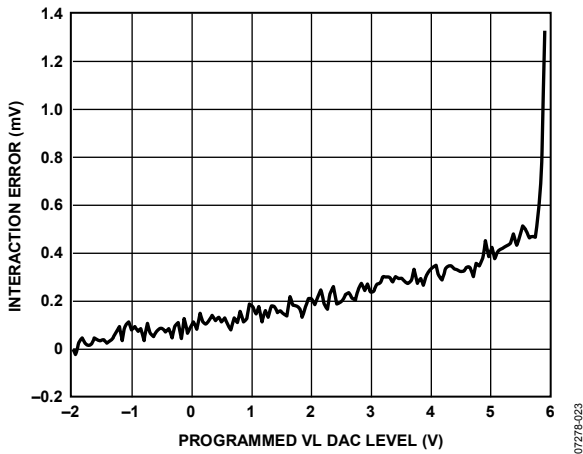

Figure 23. Driver Interaction Error;  
VH = 6.0 V; VL Swept from -2.0 V to +5.9 V

07278-023

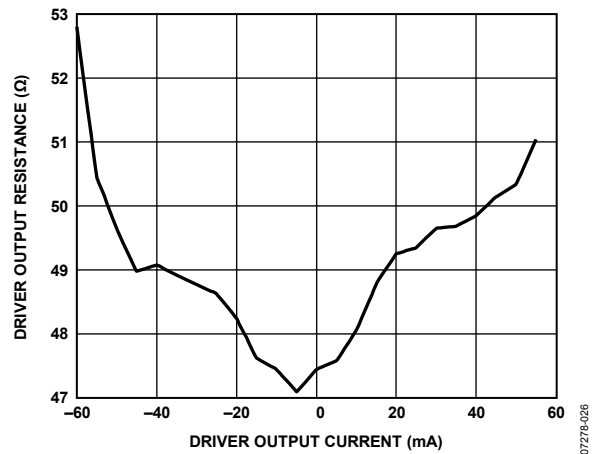

Figure 26. Driver Output Resistance vs. Output Current

07278-026

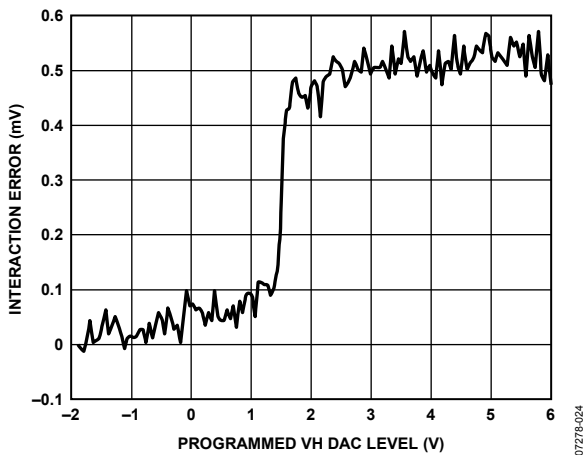

Figure 24. Driver Interaction Error;  
VT = 1.5 V; VH Swept from -1.9 V to +6.0 V

07278-024

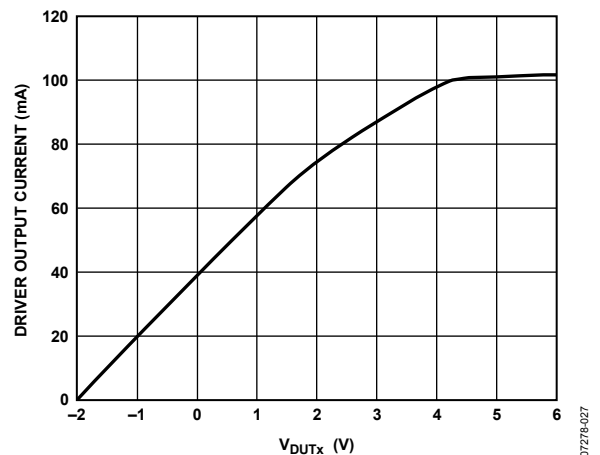

Figure 27. Driver Output Current Limit;  
Driver Programmed to -2.0 V; V<sub>DUTx</sub> Swept from -2.0 V to +6.0 V

07278-027

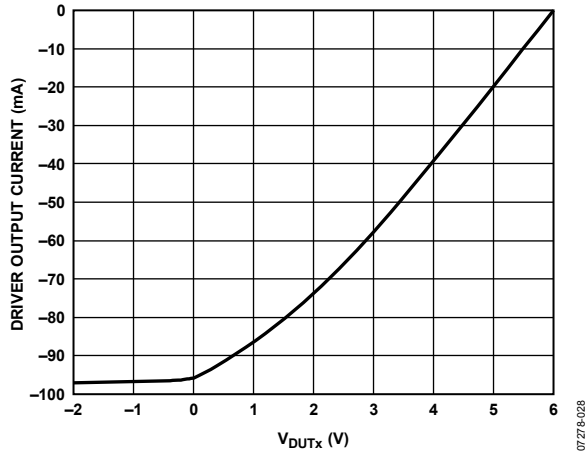

Figure 28. Driver Output Current Limit; Driver Programmed to 6.0 V;  $V_{DUTx}$  Swept from -2.0 V to +6.0 V

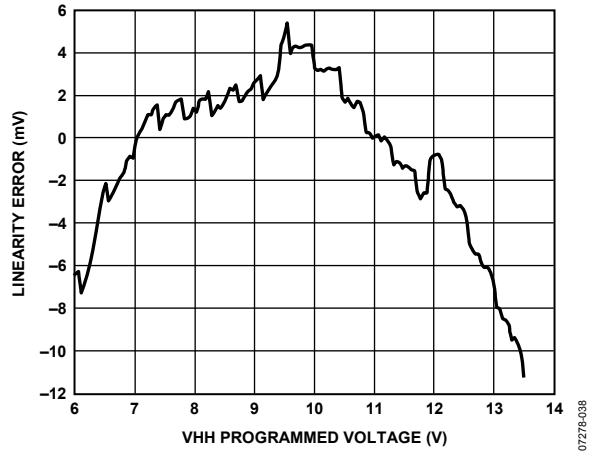

Figure 31. HVOUT VHH Linearity Error

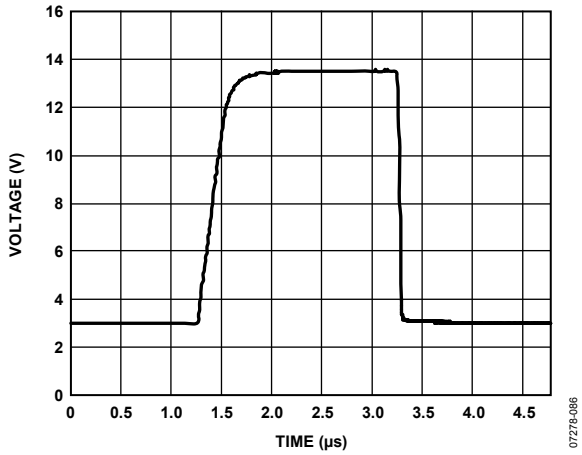

Figure 29. HVOUT VHH Response; VHH = 13.5 V

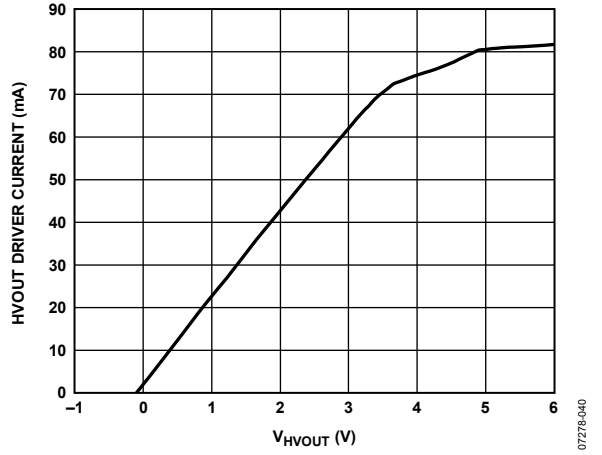

Figure 32. HVOUT VH Current Limit; VH = -0.1 V;  $V_{HVOUT}$  Swept from -0.1 V to +6.0 V

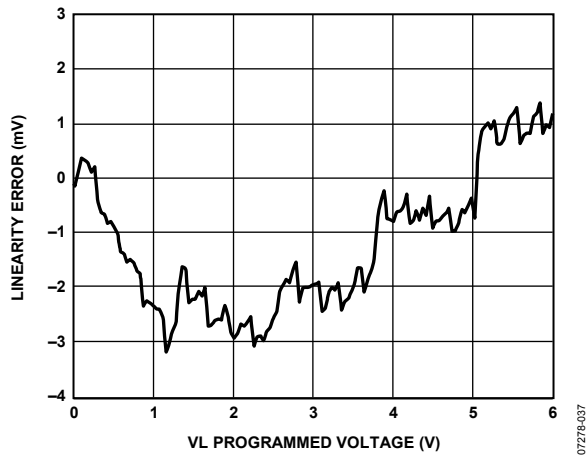

Figure 30. HVOUT VL Linearity Error

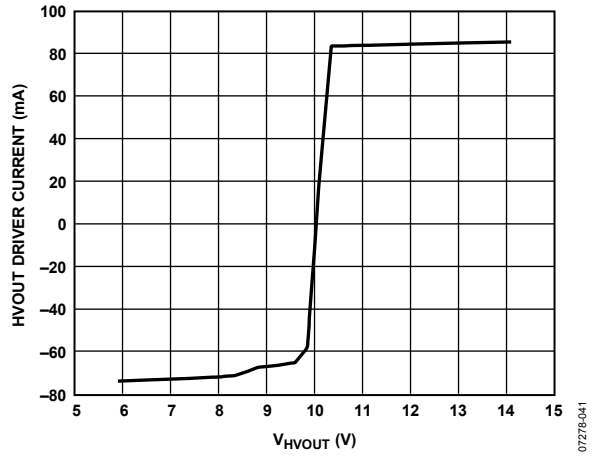

Figure 33. HVOUT VHH Current Limit; VHH = 10.0 V;  $V_{HVOUT}$  Swept from 5.9 V to 14.1 V

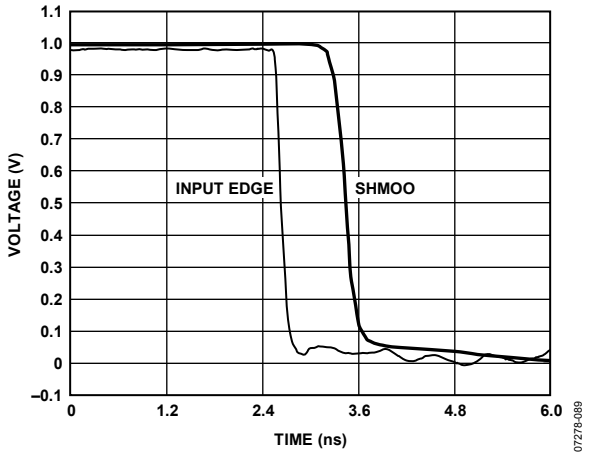

Figure 34. Comparator Shmoo;  
1.0 V Swing; 200 ps (10%/90%)

07276-089

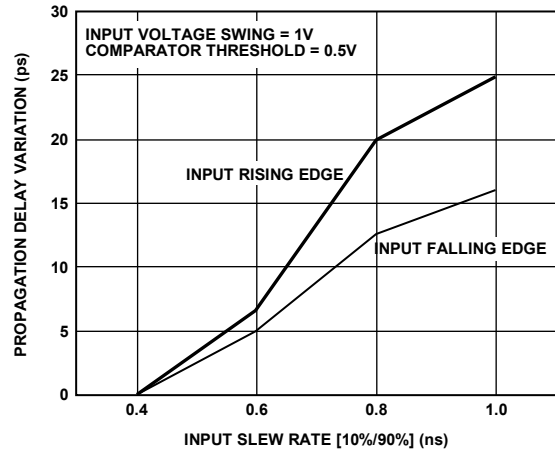

Figure 37. Comparator Slew Rate Dispersion

07276-087

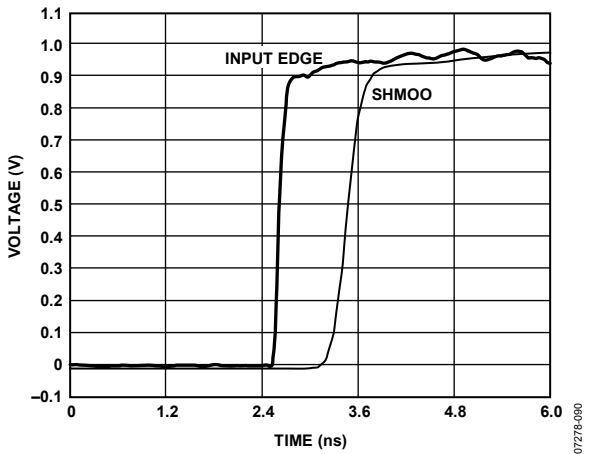

Figure 35. Comparator Shmoo;  
1.0 V Swing; 200 ps (10%/90%)

07276-090

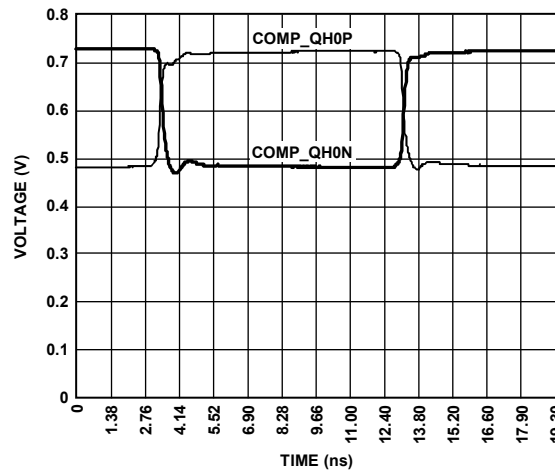

Figure 38. Comparator Output Waveform; COMP\_QH0P, COMP\_QH0N

07276-088

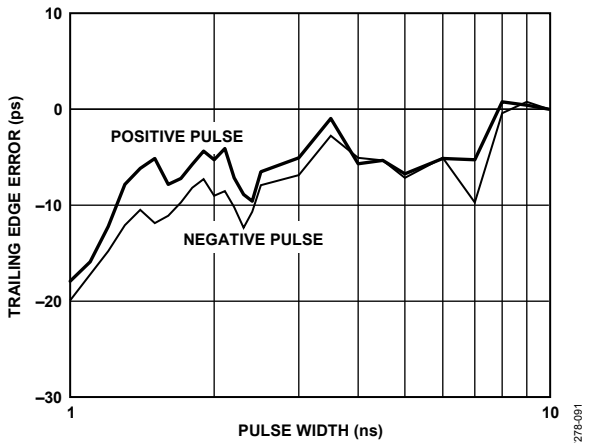

Figure 36. Comparator Minimum Pulse Width Input;  
1.0 V Swing; 200 ps (10%/90%)

07276-091

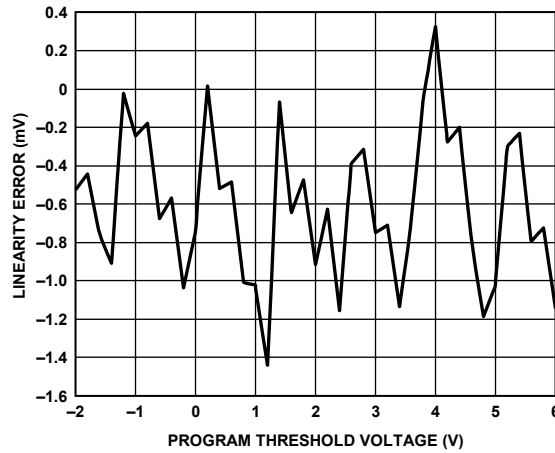

Figure 39. Comparator Threshold Linearity

07276-093



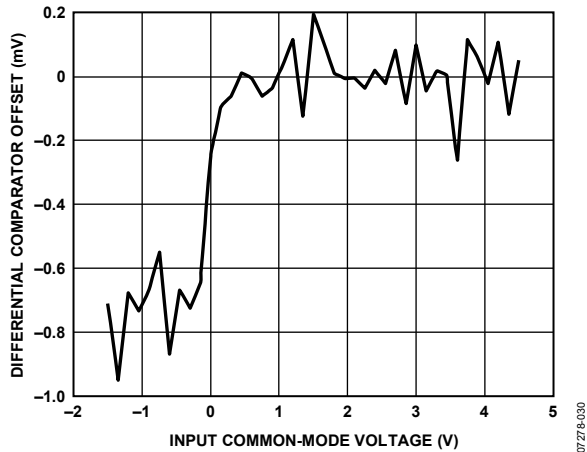

Figure 40. Differential Comparator CMRR

07278-030

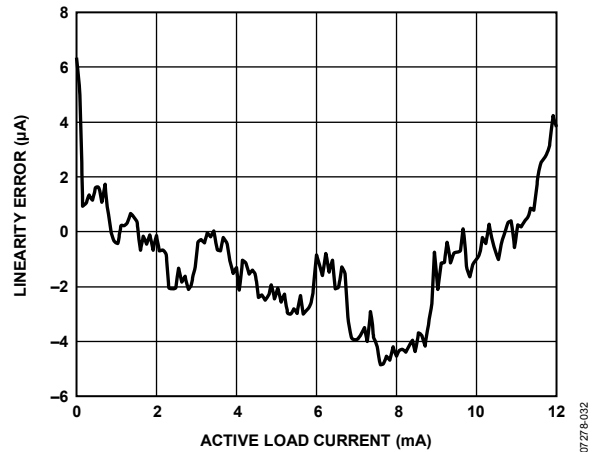

Figure 43. Active Load Current Linearity

07278-032

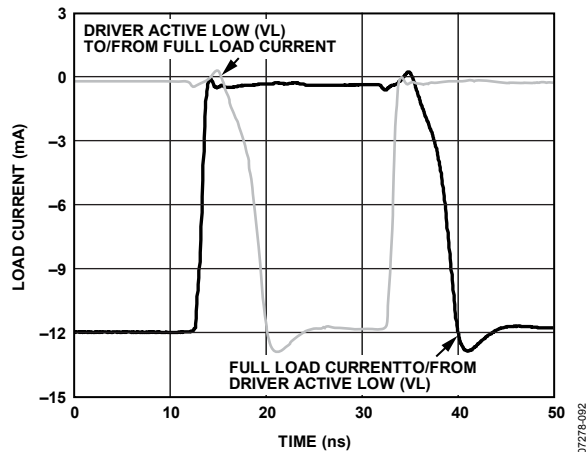

Figure 41. Active Load Response

07278-092

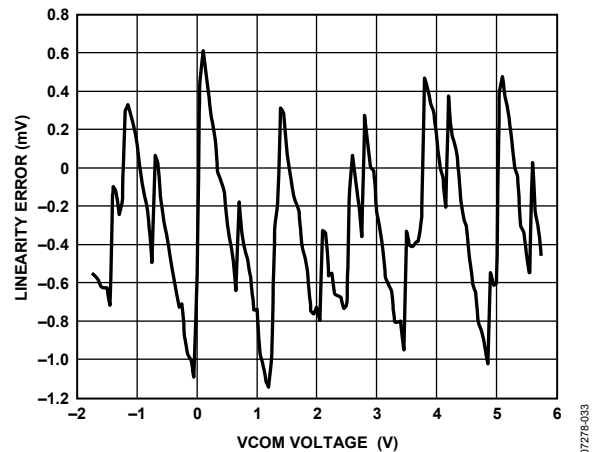

Figure 44. Active Load VCOM Linearity

07278-033

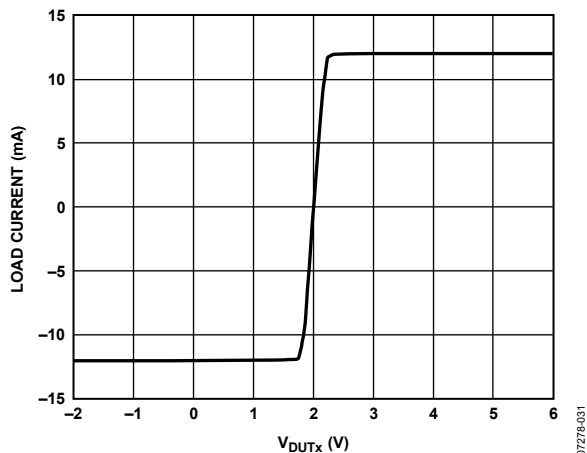

Figure 42. Active Load Commutation Response;  
VCOM = 2.0 V; IOH = IOL = 12 mA

07278-031

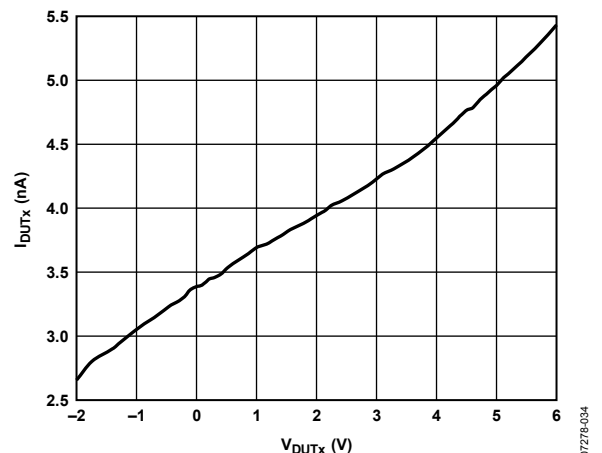

Figure 45. DUTx Pin Leakage Current in Low Leakage Mode

07278-034

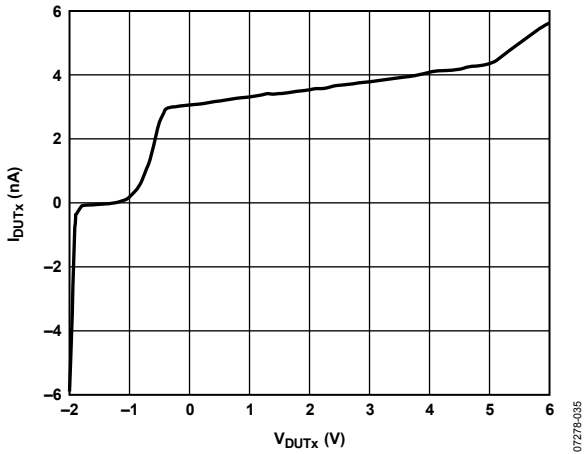

Figure 46. DUTx Pin Leakage Current in High-Z Mode

07278-035

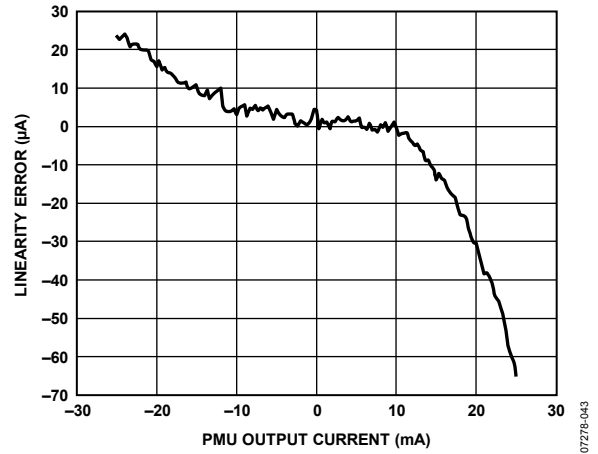

Figure 49. PMU Force Current Range A Linearity

07278-043

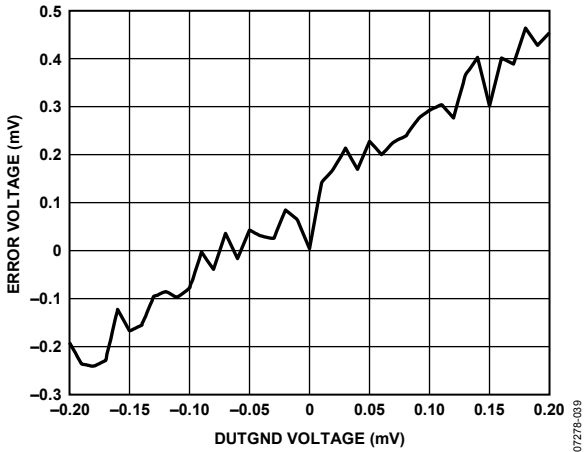

Figure 47. DUTGND Voltage Effects

07278-039

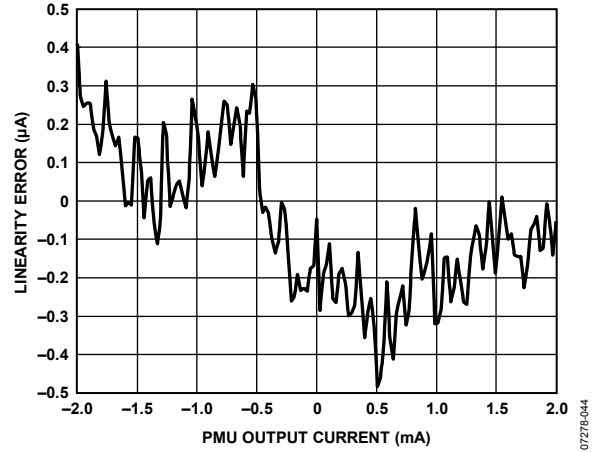

Figure 50. PMU Force Current Range B Linearity

07278-044

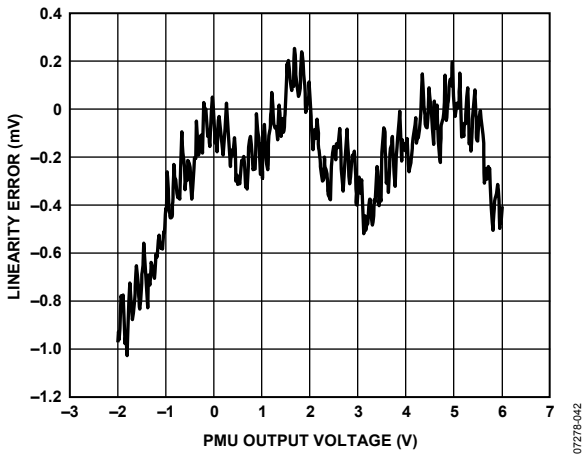

Figure 48. PMU Force Voltage Linearity

07278-042

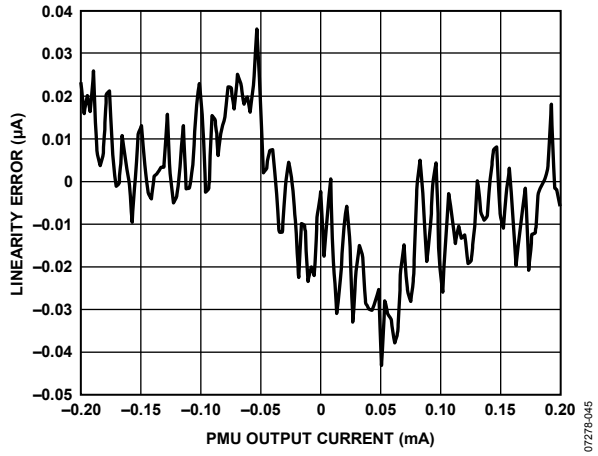

Figure 51. PMU Force Current Range C Linearity

07278-045

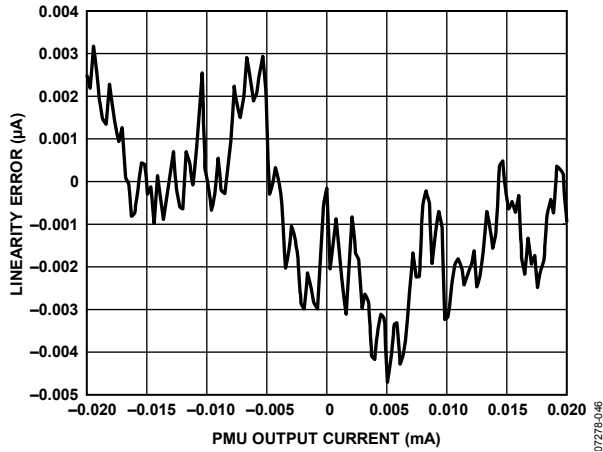

Figure 52. PMU Force Current Range D Linearity

07278-046

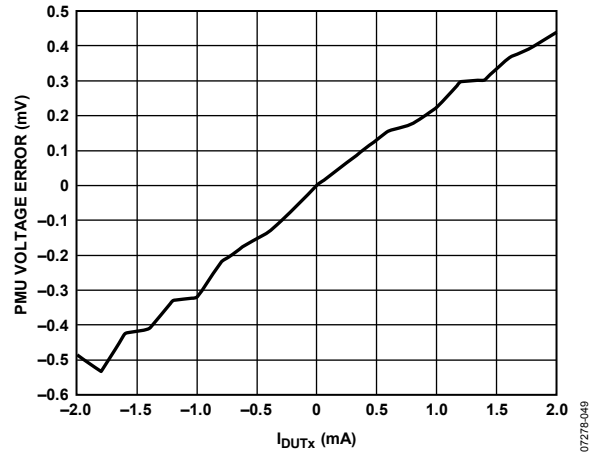

Figure 55. PMU Force Voltage Range B Output Voltage Error at -2.0 V vs. Output Current

07278-049

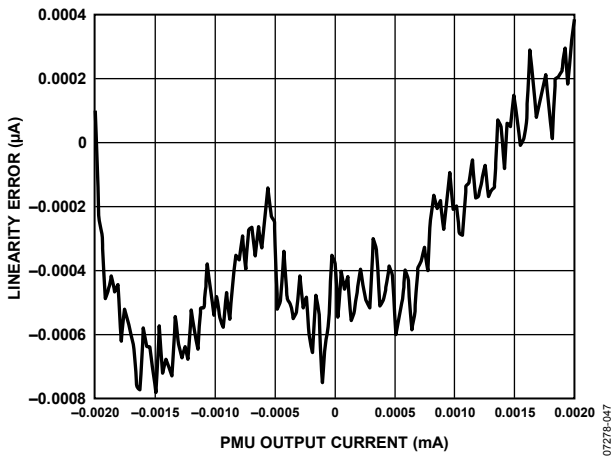

Figure 53. PMU Force Current Range E Linearity

07278-047

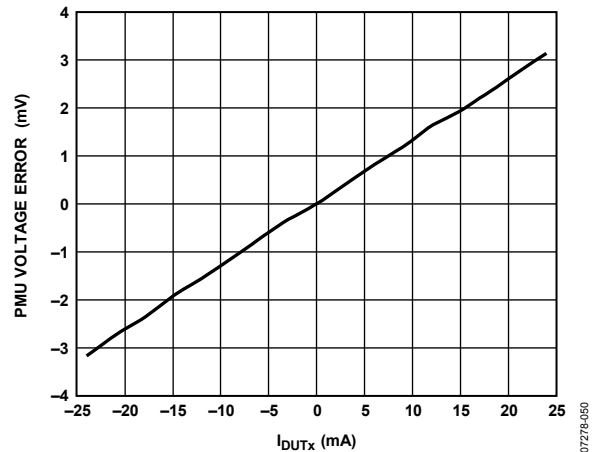

Figure 56. PMU Force Voltage Range A Output Voltage Error at 6.0 V vs. Output Current

07278-050

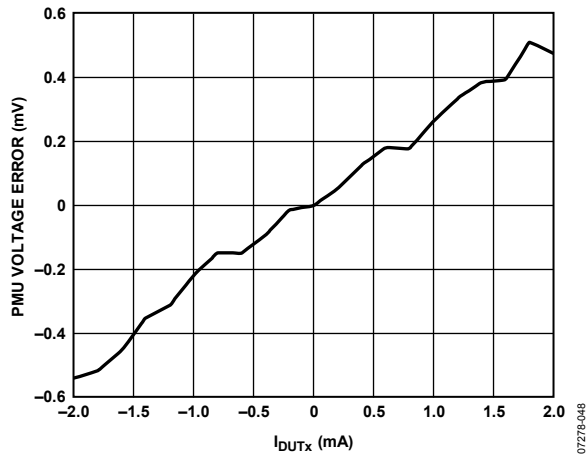

Figure 54. PMU Force Voltage Range B Output Voltage Error at 6.0 V vs. Output Current

07278-048

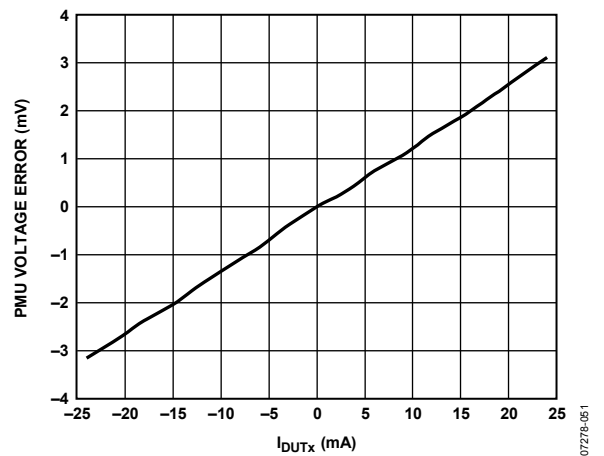

Figure 57. PMU Force Voltage Range A Output Voltage Error at -2.0 V vs. Output Current

07278-051

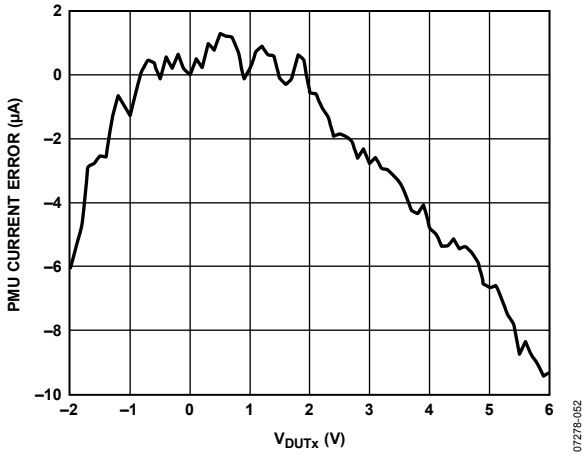

Figure 58. PMU Force Current Range A Output Current Error at -25 mA vs. Output Voltage

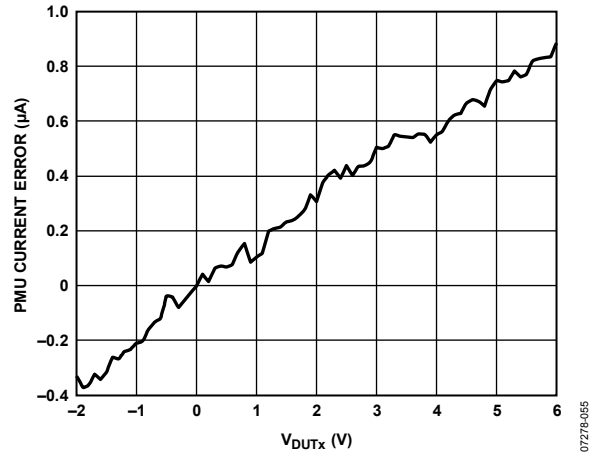

Figure 61. PMU Force Current Range B Output Current Error at 2 mA vs. Output Voltage; Output Voltage Is Pulled Externally

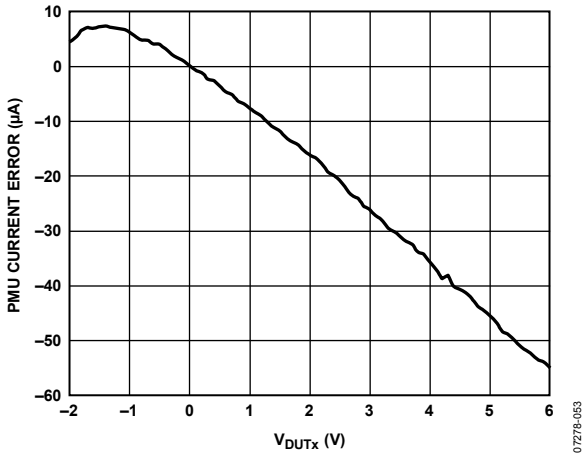

Figure 59. PMU Force Current Range A Output Current Error at 25 mA vs. Output Voltage; Output Voltage Is Pulled Externally

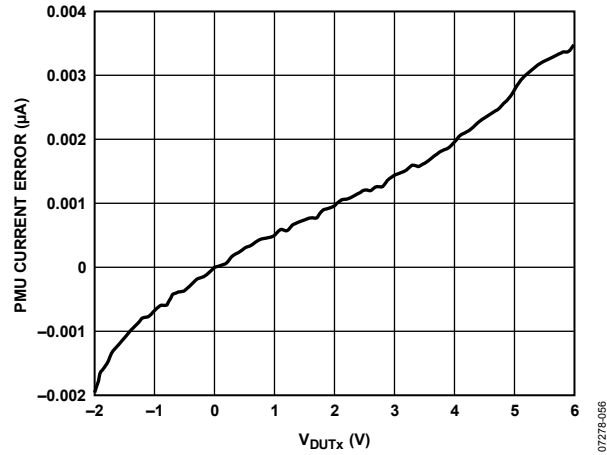

Figure 62. PMU Force Current Range E Output Current Error at -2 µA vs. Output Voltage; Output Voltage Is Pulled Externally

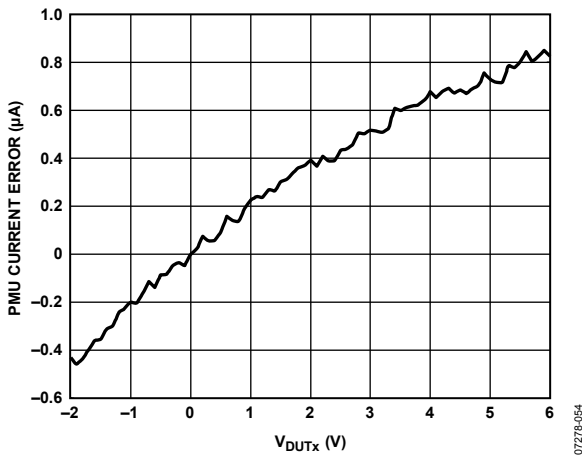

Figure 60. PMU Force Current Range B Output Current Error at -2 mA vs. Output Voltage; Output Voltage Is Pulled Externally

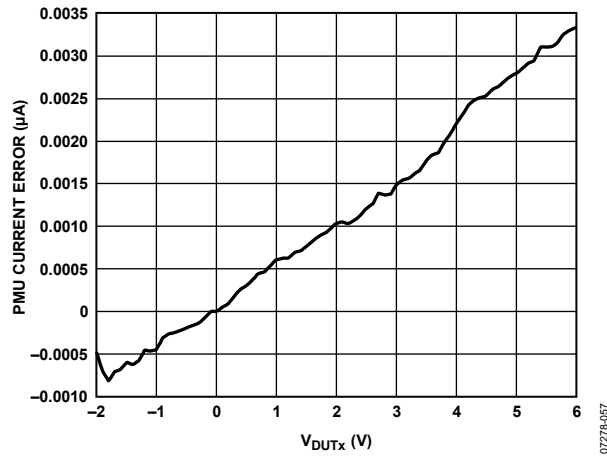

Figure 63. PMU Force Current Range E Output Current Error at 2 µA vs. Output Voltage; Output Voltage Is Pulled Externally

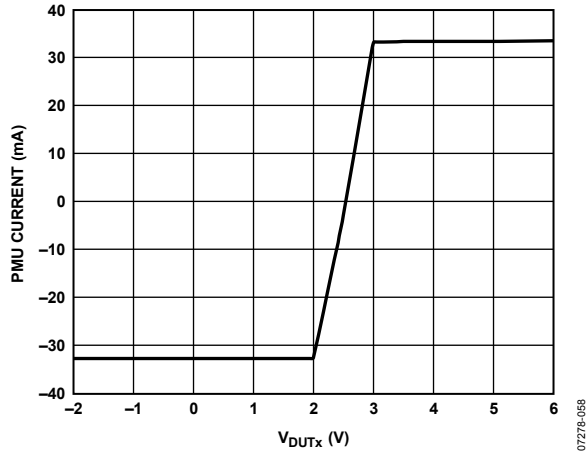

Figure 64. PMU Range A Internal Current Limit, Programmed to Force 2.5 V;  $V_{DUTx}$  Swept from -2.0 V to +6.0 V

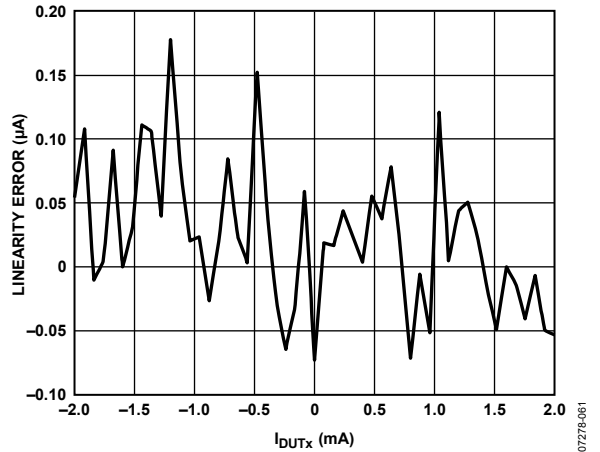

Figure 67. PMU Range B Measure Current Linearity

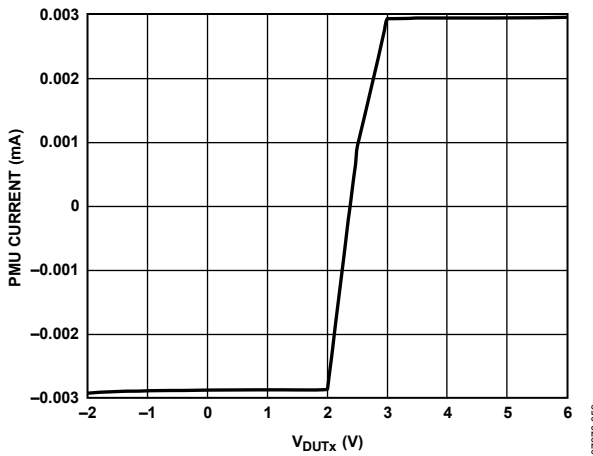

Figure 65. PMU Range E Internal Current Limit, Programmed to Force 2.5 V;  $V_{DUTx}$  Swept from -2.0 V to +6.0 V

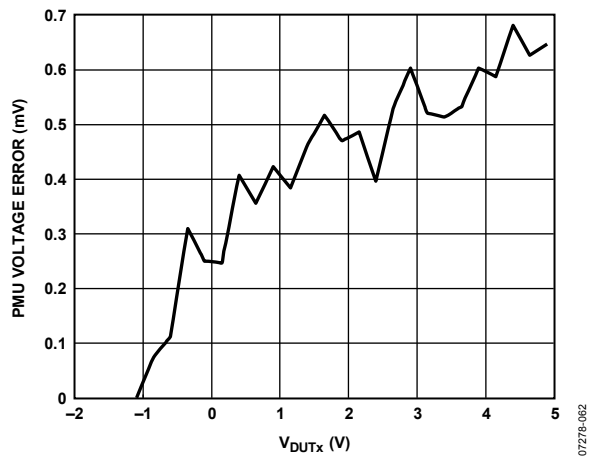

Figure 68. PMU Measure Current CMRR, Externally Pulling 1 mA, FVMI; Error of MI vs. External 1 mA

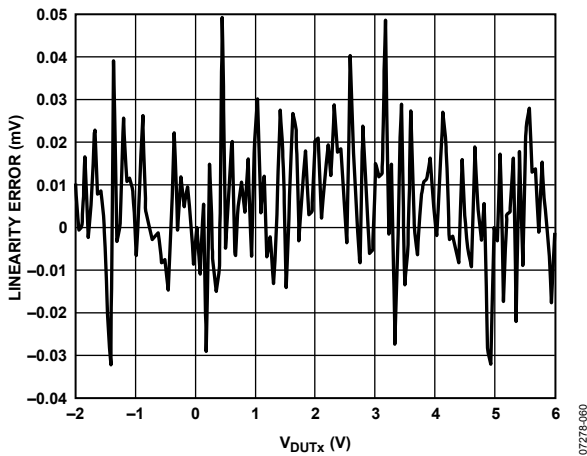

Figure 66. PMU Range B Measure Voltage Linearity

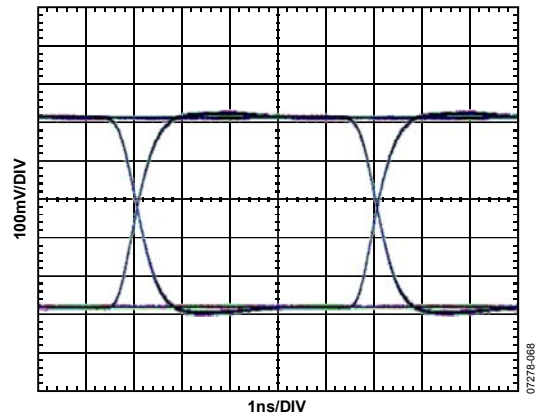

Figure 69. Eye Diagram, 200 Mbps, PRBS31;  $V_H = 1.0 V$ ;  $V_L = 0.0 V$

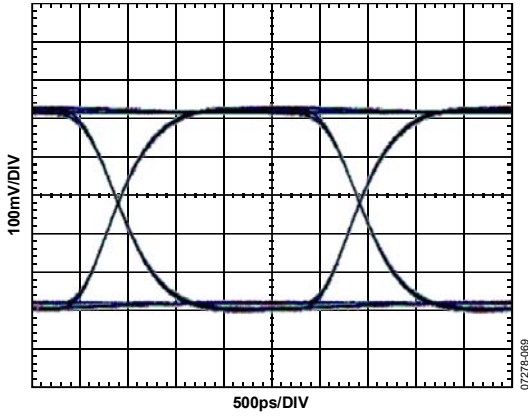

Figure 70. Eye Diagram, 400 Mbps, PRBS31;  
 $V_H = 1.0\text{ V}$ ;  $V_L = 0.0\text{ V}$

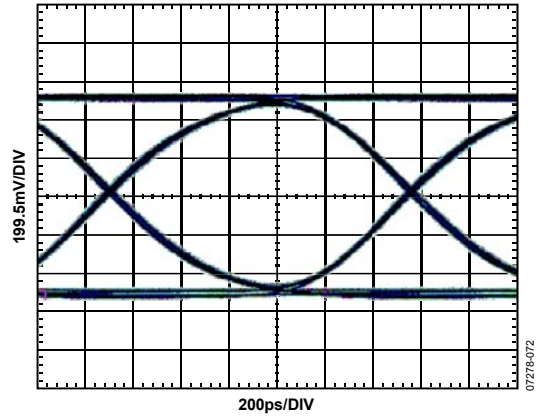

Figure 73. Eye Diagram, 800 Mbps, PRBS31;  
 $V_H = 2.0\text{ V}$ ;  $V_L = 0.0\text{ V}$

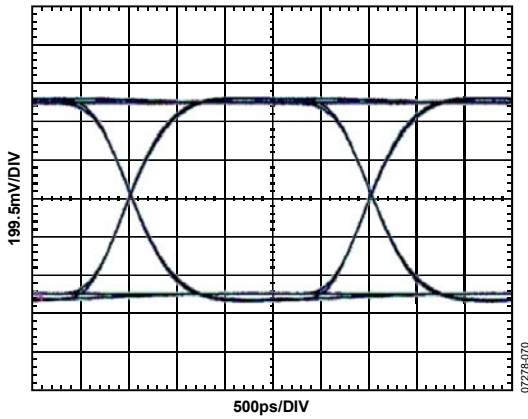

Figure 71. Eye Diagram, 400 Mbps, PRBS31;  
 $V_H = 2.0\text{ V}$ ;  $V_L = 0.0\text{ V}$

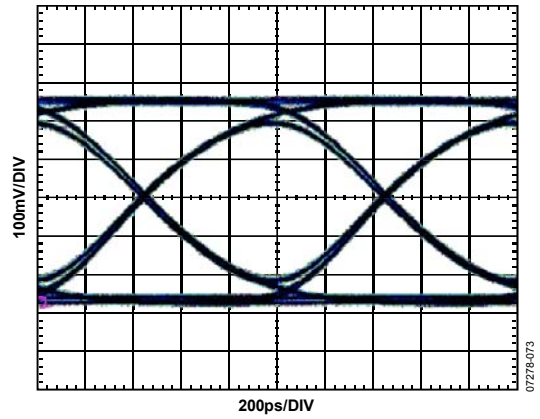

Figure 74. Eye Diagram, 1000 Mbps, PRBS31;  
 $V_H = 1.0\text{ V}$ ;  $V_L = 0.0\text{ V}$

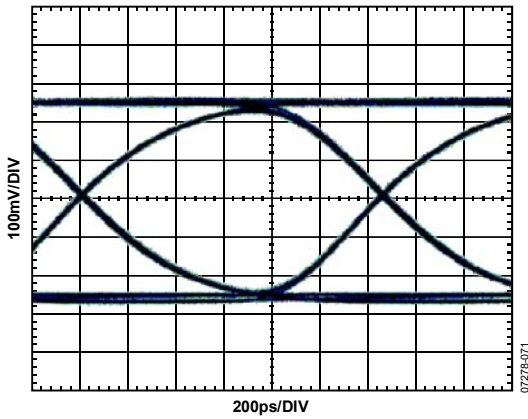

Figure 72. Eye Diagram, 800 Mbps, PRBS31;  
 $V_H = 1.0\text{ V}$ ;  $V_L = 0.0\text{ V}$

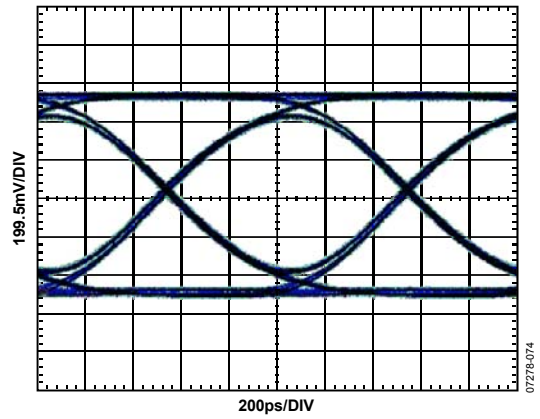

Figure 75. Eye Diagram, 1000 Mbps, PRBS31;  
 $V_H = 2.0\text{ V}$ ;  $V_L = 0.0\text{ V}$

## SERIAL PERIPHERAL INTERFACE DETAILS

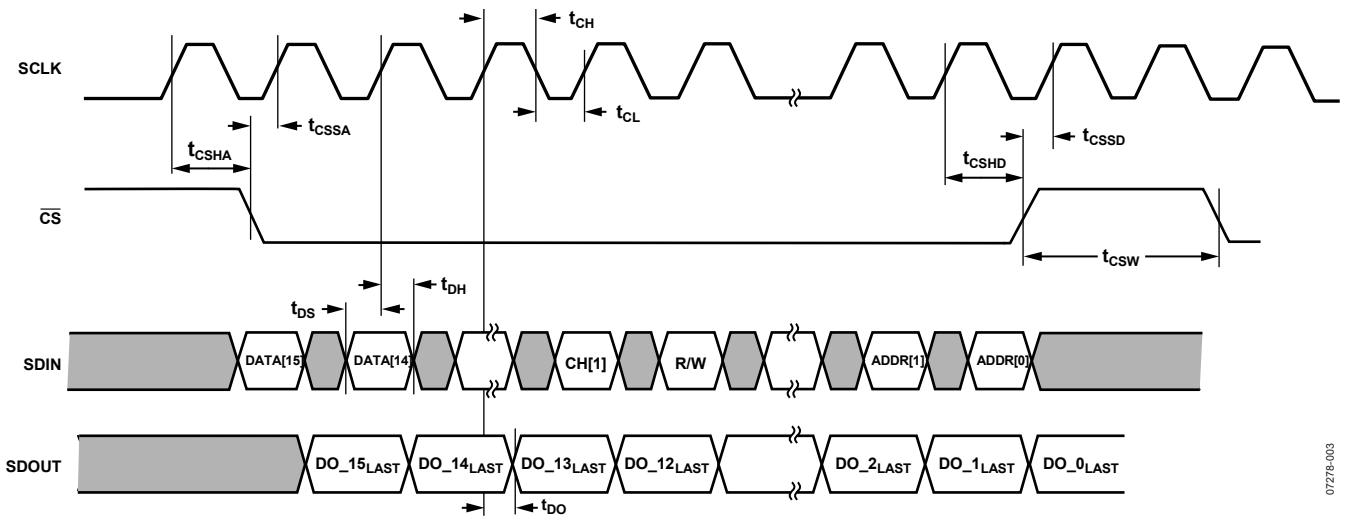

Figure 76. SPI Timing Diagram

07278-003

Table 18. Serial Peripheral Interface Timing Requirements

| Symbol            | Parameter  | Min | Max  | Unit        |
|-------------------|--|-----|------|-------------|
| t <sub>CH</sub>   | SCLK minimum high  | 9.0 |      | ns          |
| t <sub>CL</sub>   | SCLK minimum low   | 9.0 |      | ns          |
| t <sub>CSHA</sub> | $\overline{CS}$ assert hold  | 3.0 |      | ns          |
| t <sub>CSSA</sub> | $\overline{CS}$ assert setup   | 3.0 |      | ns          |
| t <sub>CSHD</sub> | $\overline{CS}$ deassert hold  | 3.0 |      | ns          |
| t <sub>CSSD</sub> | $\overline{CS}$ deassert setup   | 3.0 |      | ns          |
| t <sub>DH</sub>   | SDIN hold  | 3.0 |      | ns          |
| t <sub>DS</sub>   | SDIN setup   | 3.0 |      | ns          |
| t <sub>DO</sub>   | SDOUT Data Out   |     | 15.0 | ns          |
| t <sub>CSW</sub>  | $\overline{CS}$ minimum between assertions <sup>1</sup>  | 2   |      | SCLK cycles |
|                   | $\overline{CS}$ minimum directly after a read request  | 3   |      | SCLK cycles |
| t <sub>CSTP</sub> | Minimum delay after $\overline{CS}$ is deasserted before SCLK can be stopped (not shown in Figure 76); this allows any internal operations to complete | 16  |      | SCLK cycles |

<sup>1</sup> Extra cycle is needed after read request to prime read data into SPI shift register.

# ADATE302-02

## DEFINITION OF SPI WORD

The SPI can take variable length words, depending on the operation. At most, the word is 24 bits long: 16 bits of data, two channel selects, one R/W selector, and a 5-bit address.

Depending on the operation, the data can be smaller (or nonexistent in the case of a read operation).

### Example 1

Write 16 bits of data to a register or DAC; unused MSBs are ignored. For example, Bit 15 and Bit 14 are ignored, and Bit 13 through Bit 0 are applied to the 14-bit DAC.

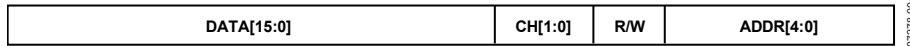

Figure 77.

### Example 2

Write 14 bits of data to the DAC.

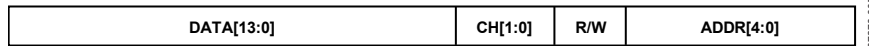

Figure 78.

### Example 3a

Write two bits of data to the 2-bit register.



Figure 79.

### Example 3b

Write two bits of data to the 2-bit register. Bit 15 through Bit 2 are ignored, while Bit 1 through Bit 0 are applied to the register.



Figure 80.

### Example 4

Read request and follow with a 2<sup>nd</sup> instruction (could be NOP) to clock out the data.

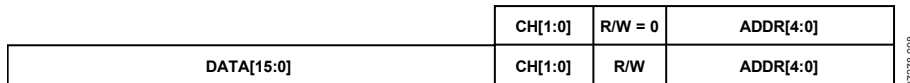

Figure 81.

Table 19. Channel Selection

| Channel 1 | Channel 0 | Channel Selected                               |
|-----------|-----------|--|
| 0         | 0         | NOP (no channel selected, no register changes) |
| 0         | 1         | Channel 0 selected                             |
| 1         | 0         | Channel 1 selected                             |
| 1         | 1         | Channel 0 and Channel 1 selected               |

Table 20. R/W Definition

| R/W | Description  |
|-----|--|
| 0   | Current register specified by address is shifted out of SDOOUT on next shift operation |
| 1   | Current data is written to register specified by address and channel select            |



**WRITE OPERATION**

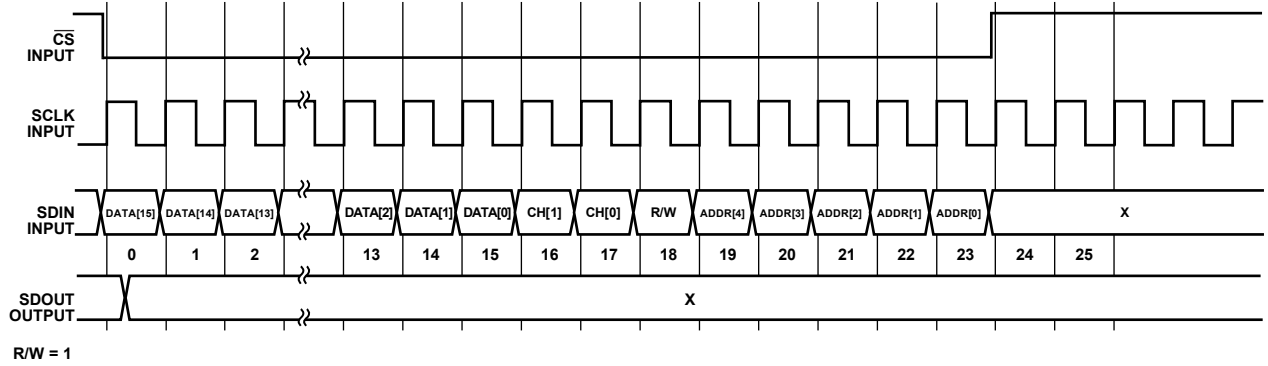

Figure 82. 16-Bit SPI Write

07278-009

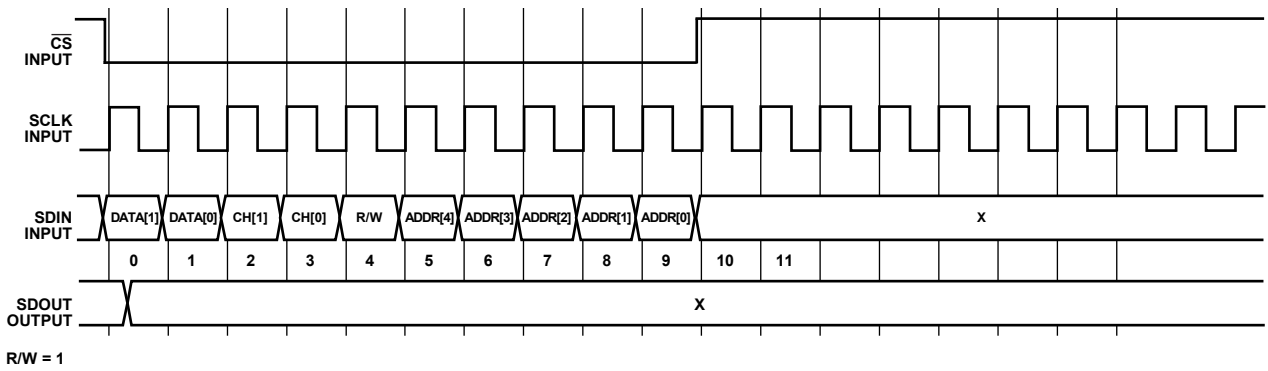

Figure 83. 2-Bit SPI Write

07278-010

# ADATE302-02

## READ OPERATION

The read operation is a two-stage operation. First, a word is shifted in, specifying which register to read.  $\overline{CS}$  is deasserted for three clock cycles, and then a second word is shifted in to get the readback data. This second word can be either another operation or an NOP address. If another operation is shifted in, it needs to shift in at least eight bits of data to read back the

previous specified data. The NOP address can be used for this read if there is no need to write/read another register. It is strongly recommended that the NOP address be used for all reads for clarity of operations.

Any register read that is less than 16 bits has zeros filled in the top bits to make it a 16-bit word.

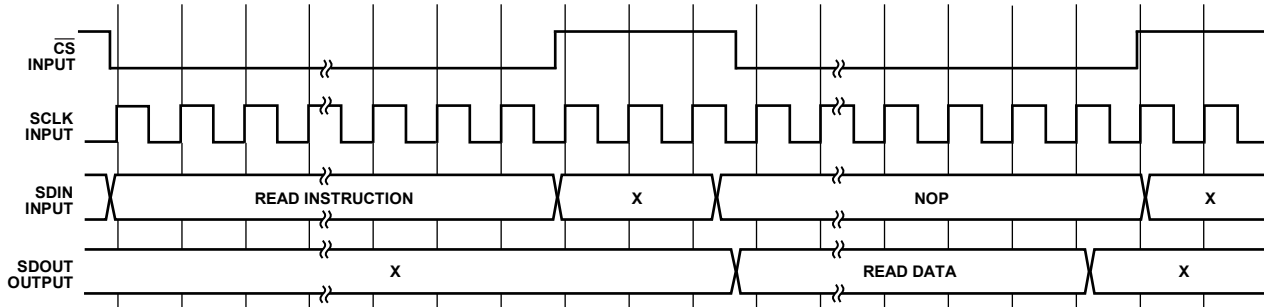

Figure 84. SPI Read Overview

07Z78-011

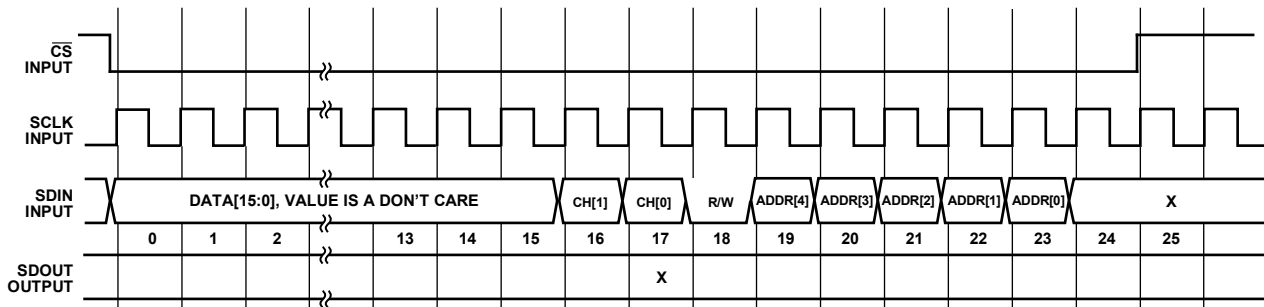
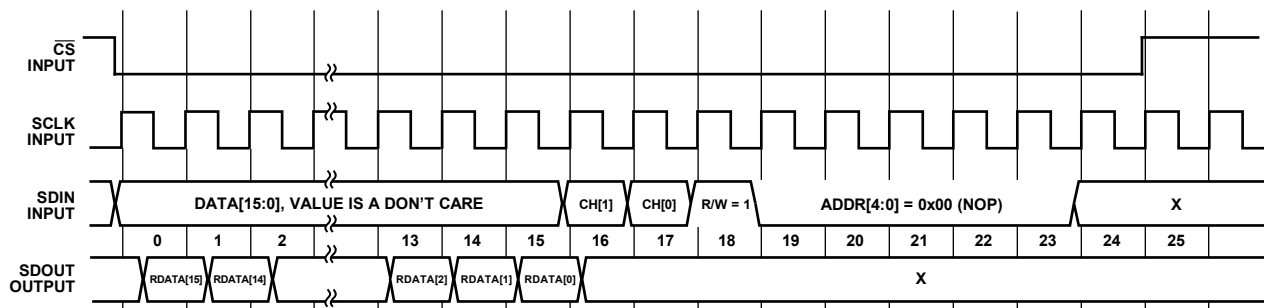

Figure 85. SPI Read—Details of Read Request

07Z78-012



RDATA IS THE REGISTER VALUE BEING READ.

Figure 86. SPI Read—Details of Read Out

07Z78-013

**RESET OPERATION**

The ADATE302-02 contains an asynchronous reset feature. The ADATE302-02 can be reset to the default values shown in Table 21

by utilizing the  $\overline{\text{RST}}$  pin. To initiate the reset operation, deassert the  $\overline{\text{RST}}$  pin for a minimum of 100 ns and deassert the  $\overline{\text{CS}}$  pin for a minimum of two SCLK cycles.

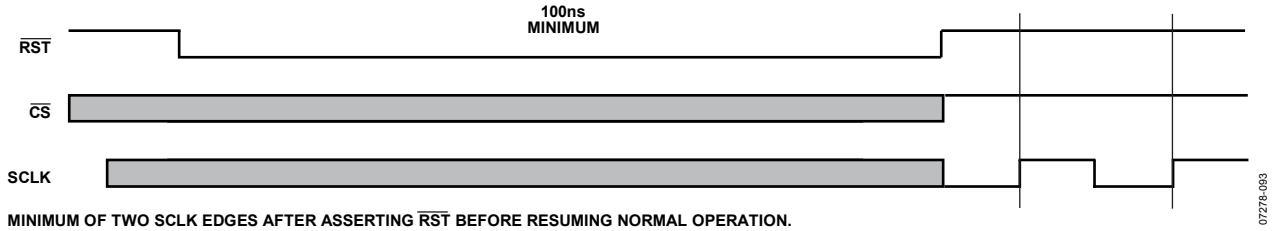

Figure 87. Reset Operation

# ADATE302-02

## REGISTER MAP

The ADDR[4:0] bits determine the destination register of the data being written to the ADATE302-02.

**Table 21. Register Selection**

| Data[15:0] | CH[1:0] | R/W | ADDR[4:0]    | Register Selected              | Reset State |
|------------|---------|-----|--------------|--------------------------------|-------------|
| N/A        | N/A     | N/A | 0x00         | NOP                            | N/A         |
| Data[13:0] | CH[1:0] | R/W | 0x01         | VH DAC level                   | 4096d       |
| Data[13:0] | CH[1:0] | R/W | 0x02         | VL DAC level                   | 4096d       |
| Data[13:0] | CH[1:0] | R/W | 0x03         | VT/VCOM DAC level              | 4096d       |
| Data[13:0] | CH[1:0] | R/W | 0x04         | VOL DAC level                  | 4096d       |
| Data[13:0] | CH[1:0] | R/W | 0x05         | VOH DAC level                  | 4096d       |
| Data[13:0] | CH[1:0] | R/W | 0x06         | VCH DAC level                  | 4096d       |
| Data[13:0] | CH[1:0] | R/W | 0x07         | VCL DAC level                  | 4096d       |
| Data[13:0] | CH[1:0] | R/W | 0x08         | V(IOH ) DAC level              | 4096d       |
| Data[13:0] | CH[1:0] | R/W | 0x09         | V(IOL ) DAC level              | 4096d       |
| Data[13:0] | CH[1]   | R/W | 0x0A         | OVD high level                 | 4096d       |
| Data[13:0] | CH[0]   | R/W | 0x0A         | OVD low level                  | 4096d       |
| Data[15:0] | CH[1:0] | R/W | 0x0B         | PMUDAC level                   | 16384d      |
| Data[2:0]  | CH[1:0] | R/W | 0x0C         | PE/PMU enable                  | 000b        |
| Data[2:0]  | CH[1:0] | R/W | 0x0D         | Channel state                  | 000b        |
| Data[9:0]  | CH[1:0] | R/W | 0x0E         | PMU state                      | 0d          |
| Data[2:0]  | CH[1:0] | R/W | 0x0F         | PMU measure enable             | 000b        |
| Data[0]    | CH[1:0] | R/W | 0x10         | Differential comparator enable | 0b          |
| Data[1:0]  | CH[1:0] | R/W | 0x11         | 16-bit DAC monitor             | 00b         |
| Data[1:0]  | CH[1:0] | R/W | 0x12         | OVD_CHx alarm mask             | 01b         |
| Data[2:0]  | CH[1:0] | R   | 0x13         | OVD_CHx alarm state            | N/A         |
| N/A        | N/A     | N/A | 0x14 to 0x1F | Reserved                       | N/A         |

## DETAILS OF REGISTERS

**Table 22. PE/PMU Enable (ADDR[4:0] = 0x0C)**

| Bit     | Name       | Description   |
|---------|------------|---|
| Data[2] | PMU enable | 0 = disable PMU force output and clamps, place PMU in MV mode<br>1 = enable PMU force output  |
| Data[1] | Force VT   | 0 = normal driver operation<br>1 = force driver to $V_T$<br>When set to 0, the PMU State bits are ignored, except for PMU Sense Path (Data[7]). |
| Data[0] | PE disable | 0 = enable driver functions<br>1 = disable driver (low leakage)<br>See Table 30 for complete functionality of this bit.                         |

**Table 23. Channel State (ADDR[4:0] = 0x0D)**

| Bit     | Name              | Description   |
|---------|-------------------|---|
| Data[2] | HVOUT mode select | 0 = HVOUT driver in low impedance<br>1 = enable HVOUT driver<br>This bit affects Channel 0 only. Ensure that Channel 0 bit in SPI write is active.<br>Channel 1 bit in SPI write is don't care. |
| Data[1] | Load enable       | 0 = disable load<br>1 = enable load<br>See Table 30 for complete functionality of this bit.   |
| Data[0] | Driver high-Z/VT  | 0 = enable driver high-Z function<br>1 = enable driver VTERM function<br>See Table 30 for complete functionality of this bit.   |

**Table 24. PMU State (ADDR[4:0] = 0x0E)<sup>1, 2</sup>**

| Bit       | Name                | Description   |
|-----------|---------------------|---|
| Data[9:8] | PMU input selection | 00 = $V_{DUTGND}$ (calibrated for 0.0 V voltage reference)<br>01 = $2.5 V + V_{DUTGND}$ (calibrated for 0.0 A current reference)<br>1X = PMUDAC |
| Data[7]   | PMU sense path      | 0 = internal sense<br>1 = external sense  |
| Data[6]   | Reserved            |   |
| Data[5]   | PMU clamp enable    | 0 = disable clamps<br>1 = enable clamps   |
| Data[4]   | PMU measure V/I     | 0 = measure voltage mode<br>1 = measure current mode  |
| Data[3]   | PMU force V/I       | 0 = force voltage mode<br>1 = force current mode  |
| Data[2:0] | PMU range           | 0XX = Range E (2 $\mu$ A)<br>100 = Range D (20 $\mu$ A)<br>101 = Range C (200 $\mu$ A)<br>110 = Range B (2 mA)<br>111 = Range A (25 mA)         |

<sup>1</sup> Note that when the ADDR[4:0] = 0x0C PMU enable bit (Data[2]) = 0, the PMU force outputs and clamps are disabled, and the PMU is placed into measure voltage mode. Data[9:8] and Data[6:0] of the PMU state register are ignored, and only Data[7], the PMU sense path bit, is valid.

<sup>2</sup> X = don't care.

# ADATE302-02

**Table 25. PMU Measure Enable (ADDR[4:0] = 0x0F)<sup>1</sup>**

| Bit       | Name                    | Description   |
|-----------|-------------------------|---|
| Data[2:1] | MEASOUT01 select        | 00 = PMU MEASOUT Channel 0<br>01 = PMU MEASOUT Channel 1<br>10 = Temp sensor ground reference<br>11 = Temp sensor |
| Data[0]   | MEASOUT01 output enable | 0 = MEASOUT01 is tristated<br>1 = MEASOUT01 is enabled  |

<sup>1</sup> This register is written to or read from if either of the CH[1:0] bits is 1.

**Table 26. Differential Comparator Enable (ADDR[4:0] = 0x10)<sup>1</sup>**

| Bit     | Name                           | Description  |
|---------|--------------------------------|--|
| Data[0] | Differential comparator enable | 0 = differential comparator is disabled, Channel 0 normal window comparator (NWC) outputs are on Channel 0<br>1 = differential comparator is enabled, the differential comparator outputs are on Channel 0 |

<sup>1</sup> This register is written to or read from if either of the CH[1:0] bits is 1.

**Table 27. DAC16\_MON (16-Bit DAC Monitor) (ADDR[4:0] = 0x11)<sup>1</sup>**

| Bit     | Name                  | Description  |
|---------|-----------------------|--|
| Data[1] | 16-bit DAC mux enable | 0 = 16-bit DAC mux is tristated<br>1 = 16-bit DAC mux is enabled |
| Data[0] | 16-bit DAC mux select | 0 = 16-bit DAC Channel 0<br>1 = 16-bit DAC Channel 1             |

<sup>1</sup> This register is written to or read from if either of the CH[1:0] bits is 1.

**Table 28. OVD\_CHx Alarm Mask (ADDR[4:0] = 0x12)**

| Bit     | Name     | Description   |
|---------|----------|---|
| Data[1] | PMU mask | 0 = disable PMU alarm flag<br>1 = enable PMU alarm flag |
| Data[0] | OVD mask | 0 = disable OVD alarm flag<br>1 = enable OVD alarm flag |

**Table 29. OVD\_CHx Alarm State (ADDR[4:0] = 0x13)<sup>1</sup>**

| Bit     | Name           | Description  |
|---------|----------------|--|
| Data[2] | PMU clamp flag | 0 = PMU not clamped<br>1 = PMU clamped                                   |
| Data[1] | OVD high flag  | 0 = DUT voltage < OVD high voltage<br>1 = DUT voltage > OVD high voltage |
| Data[0] | OVD low flag   | 0 = DUT voltage > OVD low voltage<br>1 = DUT voltage < OVD low voltage   |

<sup>1</sup> This register is a read-only register.

## USER INFORMATION

Table 30. Driver and Load Truth Table<sup>1</sup>

| Registers                                 |   |  |   | Signals |      | Driver State          | Load State |
|---|---|--|---|---------|------|-----------------------|------------|
| PE Disable<br>Data[0]<br>ADDR[4:0] = 0x0C | Force VT<br>Data[1]<br>ADDR[4:0] = 0x0C | Load Enable<br>Data[1]<br>ADDR[4:0] = 0x0D | Driver High-Z/VT<br>Data[0]<br>ADDR[4:0] = 0x0D | DATAx   | RCVx |                       |            |
| 1   | X                                       | X  | X   | X       | X    | High-Z without clamps | Power-down |
| 0   | 1                                       | X  | X   | X       | X    | VT                    | Power-down |
| 0   | 0                                       | 0  | 0   | 0       | 0    | VL                    | Power-down |
| 0   | 0                                       | 0  | 0   | 0       | 1    | High-Z with clamps    | Power-down |
| 0   | 0                                       | 0  | 0   | 1       | 0    | VH                    | Power-down |
| 0   | 0                                       | 0  | 0   | 1       | 1    | High-Z with clamps    | Power-down |
| 0   | 0                                       | 0  | 1   | 0       | 0    | VL                    | Power-down |
| 0   | 0                                       | 0  | 1   | 0       | 1    | VT                    | Power-down |
| 0   | 0                                       | 0  | 1   | 1       | 0    | VH                    | Power-down |
| 0   | 0                                       | 0  | 1   | 1       | 1    | VT                    | Power-down |
| 0   | 0                                       | 1  | 0   | 0       | 0    | VL                    | Active off |
| 0   | 0                                       | 1  | 0   | 0       | 1    | High-Z with clamps    | Active on  |
| 0   | 0                                       | 1  | 0   | 1       | 0    | VH                    | Active off |
| 0   | 0                                       | 1  | 0   | 1       | 1    | High-Z with clamps    | Active on  |
| 0   | 0                                       | 1  | 1   | 0       | 0    | VL                    | Active on  |
| 0   | 0                                       | 1  | 1   | 0       | 1    | High-Z with clamps    | Active on  |
| 0   | 0                                       | 1  | 1   | 1       | 0    | VH                    | Active on  |
| 0   | 0                                       | 1  | 1   | 1       | 1    | High-Z with clamps    | Active on  |

<sup>1</sup> X = don't care.

Table 31. HVOUT Truth Table<sup>1</sup>

| HVOUT Mode Select<br>Data[2]<br>ADDR[4:0] = 0x0D | Channel 0<br>RCV | Channel 0<br>Data | HVOUT Driver Output   |
|--|------------------|-------------------|---|
| 1  | 1                | X                 | VHH mode; $V_{HH} = (VT + 1V) \times 2 + DUTGND$ (Channel 0 VT DAC) |
| 1  | 0                | 0                 | VL (Channel 0 VL DAC)   |
| 1  | 0                | 1                 | VH (Channel 0 VH DAC)   |
| 0  | X                | X                 | Disabled (HVOUT pin set to 0 V low impedance)                       |

<sup>1</sup> X = don't care.

Table 32. Comparator Truth Table

| Differential<br>Comparator Enable<br>Data[0]<br>ADDR[4:0] = 0x10 | COMP_QH0  | COMP_QL0  | COMP_QH1  | COMP_QL1  |
|--|---|---|---|---|
| 0  | Normal window mode<br>Logic high: $VOH0 < V_{DUT0}$<br>Logic low: $VOH0 > V_{DUT0}$                                 | Normal window mode<br>Logic high: $VOL0 < V_{DUT0}$<br>Logic low: $VOL0 > V_{DUT0}$                                 | Normal window mode<br>Logic high: $VOH1 < V_{DUT1}$<br>Logic low: $VOH1 > V_{DUT1}$ | Normal window mode<br>Logic high: $VOL1 < V_{DUT1}$<br>Logic low: $VOL1 > V_{DUT1}$ |
| 1  | Differential comparator mode<br>Logic high: $VOH0 < V_{DUT0} - V_{DUT1}$<br>Logic low: $VOH0 > V_{DUT0} - V_{DUT1}$ | Differential comparator mode<br>Logic high: $VOL0 < V_{DUT0} - V_{DUT1}$<br>Logic low: $VOL0 > V_{DUT0} - V_{DUT1}$ | Normal window mode<br>Logic high: $VOH1 < V_{DUT1}$<br>Logic low: $VOH1 > V_{DUT1}$ | Normal window mode<br>Logic high: $VOL1 < V_{DUT1}$<br>Logic low: $VOL1 > V_{DUT1}$ |

# ADATE302-02

## DETAILS OF DACs vs. LEVELS

There are ten 14-bit DACs per channel. These DACs provide levels for the driver, comparator, load currents, VHH buffer, OVD, and clamp levels. There are three versions of output levels:

- -2.5 V to +7.5 V; tracks DUTGND. Controls VH, VL, VT/VCOM/VHH, VOH, VOL, VCH, and VCL levels.
- -3.0 V to +7.0 V; tracks DUTGND. Controls OVD levels.
- -2.5 V to +7.5 V; does not track DUTGND. Controls IOH and IOL levels.

There is one 16-bit DAC per channel. This DAC provides the levels for the PMU. The output level is:

- -2.5 V to +7.5 V; tracks DUTGND. Controls PMU levels.

**Table 33. Level Transfer Functions**

| DAC Transfer Function   | Programmable Range <sup>1</sup><br>(All 0s to All 1s) | Levels                              |
|---|---|-------------------------------------|
| $V_{OUT} = 2.0 \times (V_{REF} - V_{REF\_GND}) \times (\text{Code}/(2^{14})) - 0.5 \times (V_{REF} - V_{REF\_GND}) + V_{DUTGND}$<br>Code = $[V_{OUT} - V_{DUTGND} + 0.5 \times (V_{REF} - V_{REF\_GND})] \times [(2^{14})/(2.0 \times (V_{REF} - V_{REF\_GND}))]$                                   | -2.5 V to +7.5 V                                      | VH, VL, VT/VCOM, VOL, VOH, VCH, VCL |
| $V_{OUT} = 4.0 \times (V_{REF} - V_{REF\_GND}) \times (\text{Code}/(2^{14})) - 1.0 \times (V_{REF} - V_{REF\_GND}) + 2.0 + V_{DUTGND}$<br>Code = $[V_{OUT} - V_{DUTGND} - 2.0 + 1.0 \times (V_{REF} - V_{REF\_GND})] \times [(2^{14})/(4.0 \times (V_{REF} - V_{REF\_GND}))]$                       | -3.0 V to +17.0 V                                     | VHH                                 |
| $V_{OUT} = 2.0 \times (V_{REF} - V_{REF\_GND}) \times (\text{Code}/(2^{14})) - 0.6 \times (V_{REF} - V_{REF\_GND}) + V_{DUTGND}$<br>Code = $[V_{OUT} - V_{DUTGND} + 0.6 \times (V_{REF} - V_{REF\_GND})] \times [(2^{14})/(2.0 \times (V_{REF} - V_{REF\_GND}))]$                                   | -3.0 V to +7.0 V                                      | OVD                                 |
| $I_{OUT} = [2.0 \times (V_{REF} - V_{REF\_GND}) \times (\text{Code}/(2^{14})) - 0.5 \times (V_{REF} - V_{REF\_GND})] \times (0.012/5.0)$<br>Code = $[(I_{OUT} \times (5.0/0.012)) + 0.5 \times (V_{REF} - V_{REF\_GND})] \times [(2^{14})/(2.0 \times (V_{REF} - V_{REF\_GND}))]$                   | -6 mA to +18 mA                                       | IOH, IOL                            |
| $V_{OUT} = 2.0 \times (V_{REF} - V_{REF\_GND}) \times (\text{Code}/(2^{16})) - 0.5 \times (V_{REF} - V_{REF\_GND}) + V_{DUTGND}$<br>Code = $[V_{OUT} - V_{DUTGND} + 0.5 \times (V_{REF} - V_{REF\_GND})] \times [(2^{16})/(2.0 \times (V_{REF} - V_{REF\_GND}))]$                                   | -2.5 V to +7.5 V                                      | PMUDAC                              |
| $I_{OUT} = [2.0 \times (V_{REF} - V_{REF\_GND}) \times (\text{Code}/(2^{16})) - 0.5 \times (V_{REF} - V_{REF\_GND}) - 2.5] \times (0.050/5.0)$<br>Code = $[(I_{OUT} \times (5.0/0.050)) + 2.5 + 0.5 \times (V_{REF} - V_{REF\_GND})] \times [(2^{16})/(2.0 \times (V_{REF} - V_{REF\_GND}))]$       | -50 mA to +50 mA                                      | PMUDAC<br>(PMU FI Range A)          |
| $I_{OUT} = [2.0 \times (V_{REF} - V_{REF\_GND}) \times (\text{Code}/(2^{16})) - 0.5 \times (V_{REF} - V_{REF\_GND}) - 2.5] \times (0.004/5.0)$<br>Code = $[(I_{OUT} \times (5.0/0.004)) + 2.5 + 0.5 \times (V_{REF} - V_{REF\_GND})] \times [(2^{16})/(2.0 \times (V_{REF} - V_{REF\_GND}))]$       | -4 mA to +4 mA  | PMUDAC<br>(PMU FI Range B)          |
| $I_{OUT} = [2.0 \times (V_{REF} - V_{REF\_GND}) \times (\text{Code}/(2^{16})) - 0.5 \times (V_{REF} - V_{REF\_GND}) - 2.5] \times (0.0004/5.0)$<br>Code = $[(I_{OUT} \times (5.0/0.0004)) + 2.5 + 0.5 \times (V_{REF} - V_{REF\_GND})] \times [(2^{16})/(2.0 \times (V_{REF} - V_{REF\_GND}))]$     | -400 µA to +400 µA                                    | PMUDAC<br>(PMU FI Range C)          |
| $I_{OUT} = [2.0 \times (V_{REF} - V_{REF\_GND}) \times (\text{Code}/(2^{16})) - 0.5 \times (V_{REF} - V_{REF\_GND}) - 2.5] \times (0.00004/5.0)$<br>Code = $[(I_{OUT} \times (5.0/0.00004)) + 2.5 + 0.5 \times (V_{REF} - V_{REF\_GND})] \times [(2^{16})/(2.0 \times (V_{REF} - V_{REF\_GND}))]$   | -40 µA to +40 µA                                      | PMUDAC<br>(PMU FI Range D)          |
| $I_{OUT} = [2.0 \times (V_{REF} - V_{REF\_GND}) \times (\text{Code}/(2^{16})) - 0.5 \times (V_{REF} - V_{REF\_GND}) - 2.5] \times (0.000004/5.0)$<br>Code = $[(I_{OUT} \times (5.0/0.000004)) + 2.5 + 0.5 \times (V_{REF} - V_{REF\_GND})] \times [(2^{16})/(2.0 \times (V_{REF} - V_{REF\_GND}))]$ | -4 µA to +4 µA  | PMUDAC<br>(PMU FI Range E)          |

<sup>1</sup> Programmable range includes margin outside of specified part performance, allowing for offset/gain calibration.

**Table 34. Load Transfer Functions**

| Load Level | Transfer Function <sup>1</sup>    |
|------------|-----------------------------------|
| IOL        | $V(IOL)/5 V \times 12 \text{ mA}$ |
| IOH        | $V(IOH)/5 V \times 12 \text{ mA}$ |

<sup>1</sup> V(IOH), V(IOL) DAC levels are not referenced to DUTGND.

**Table 35. PMU Transfer Functions**

| PMU Mode        | Transfer Function   |
|-----------------|---|
| Force Voltage   | $V_{OUT} = \text{PMUDAC}$   |
| Measure Voltage | $V_{MEASOUT01} = V_{DUTx}$ (internal sense) or $V_{MEASOUT01} = V_{PMUS\_CHx}$ (external sense) |
| Force Current   | $I_{OUT} = [\text{PMUDAC} - (V_{REF}/2)]/(R^1 \times 5)$  |
| Measure Current | $V_{MEASOUT01} = (V_{REF}/2) + V_{DUTGND} + (I_{DUTx} \times 5 \times R^1)$                     |

<sup>1</sup> R = 20 Ω for Range A; 250 Ω for Range B; 2.5 kΩ for Range C; 25 kΩ for Range D; 250 kΩ for Range E.



**Table 36. PMU User Required Capacitors**

| Capacitor | Location   |
|-----------|--|
| 220 pF    | Across Pin C10 (FFCAP_0B) and Pin E10 (FFCAP_0A) |
| 220 pF    | Across Pin C1 (FFCAP_1B) and Pin E1 (FFCAP_1A)   |
| 330 pF    | Between GND and Pin B9 (SCAP0)                   |
| 330 pF    | Between GND and Pin B2 (SCAP1)                   |

**Table 37. Temperature Sensor**

| Temperature | Output          |
|-------------|-----------------|
| 0 K         | 0 V             |
| 300 K       | 3 V             |
| x K         | (x K) × 10 mV/K |

**Table 38. Default Test Conditions**

| Name                           | Default Test Condition  |
|--------------------------------|---|
| VH DAC Level                   | 2.0 V   |
| VL DAC Level                   | 0.0 V   |
| VT/VCOM DAC Level              | 1.0 V   |
| VOL DAC Level                  | -2.0 V  |
| VOH DAC Level                  | 6.0 V   |
| VCH DAC Level                  | 7.5 V   |
| VCL DAC Level                  | -2.5 V  |
| IOH DAC Level                  | 0.0 A   |
| IOL DAC Level                  | 0.0 A   |
| OVD Low DAC Level              | -2.5 V  |
| OVD High DAC Level             | 6.5 V   |
| PMUDAC DAC Level               | 0.0 V   |
| PE/PMU Enable                  | 0x0000: PMU disabled, not force VT, PE enabled                          |
| Channel State                  | 0x0000: HVOUT mode disabled, load disabled, VTERM inactive              |
| PMU State                      | 0x0000: input of DUTGND, internal sense, clamps disabled, FVMV, Range E |
| PMU Measure Enable             | 0x0000: MEASOUT01 pin tristated   |
| Differential Comparator Enable | 0x0000: normal window comparator mode                                   |
| 16-Bit DAC Monitor             | 0x0000: DAC16_MON tristated   |
| OVD_CHx Alarm Mask             | 0x0000: disable alarm functions   |
| Data Input                     | Logic low   |
| Receive Input                  | Logic low   |
| DUTx Pin                       | Unterminated  |
| Comparator Output              | Unterminated  |

# ADATE302-02

## RECOMMENDED PMU MODE SWITCHING SEQUENCES

To minimize any possible aberrations and voltage spikes on the DUT output, specific mode switching sequences are recommended for the following transitions:

- PMU disable to PMU enable
- PMU force voltage mode to PMU force current mode
- PMU force current mode to PMU force voltage mode.

### **PMU Disable to PMU Enable**

Step 1: See Table 39 for state of registers in PMU disabled mode.

**Table 39.**

| Register                                 | Bit       | Setting |
|--|-----------|---------|
| PE/PMU Enable Register, ADDR[4:0] = 0x0C | Data[2]   | 0       |
| PMU State Register, ADDR[4:0] = 0x0E     | Data[9:8] | XX      |
|  | Data[7]   | X       |
|  | Data[6]   | X       |
|  | Data[5]   | X       |
|  | Data[4]   | X       |
|  | Data[3]   | X       |
|  | Data[2:0] | XXX     |

Step 2: Write to Register ADDR[4:0] = 0x0E (see Table 40).

**Table 40.**

| Register                             | Bit       | Setting  | Comments   |
|--------------------------------------|-----------|----------|--|
| PMU State Register, ADDR[4:0] = 0x0E | Data[9:8] | 1X or 00 | Set desired input selection                                      |
|                                      | Data[7]   | X        |  |
|                                      | Data[6]   | X        |  |
|                                      | Data[5]   | X        |  |
|                                      | Data[4]   | X        |  |
|                                      | Data[3]   | 0        | This bit must be set to force voltage mode to reduce aberrations |
|                                      | Data[2:0] | XXX      | Set desired range  |

Step 3: Write to Register ADDR[4:0] = 0x0C (see Table 41).

**Table 41.**

| Register                                 | Bit     | Setting | Comments                                 |
|--|---------|---------|--|
| PE/PMU Enable Register, ADDR[4:0] = 0x0C | Data[2] | 1       | PMU is now enabled in force voltage mode |

**PMU Force Voltage Mode to PMU Force Current Mode**

Step 1: See Table 42 for state of registers in force voltage mode.

**Table 42.**

| Register                                 | Bit       | Setting |
|--|-----------|---------|
| PE/PMU Enable Register, ADDR[4:0] = 0x0C | Data[2]   | 1       |
| PMU State Register, ADDR[4:0] = 0x0E     | Data[9:8] | XX      |
|  | Data[7]   | X       |
|  | Data[6]   | X       |
|  | Data[5]   | X       |
|  | Data[4]   | X       |
|  | Data[3]   | 0       |
|  | Data[2:0] | XXX     |

Step 2: Write to Register ADDR[4:0] = 0x0E (see Table 43).

**Table 43.**

| Register                             | Bit       | Setting | Comments  |
|--------------------------------------|-----------|---------|---|
| PMU State Register, ADDR[4:0] = 0x0E | Data[9:8] | 01      | Set 2.5 V + $V_{DUTGND}$ input selection                                    |
|                                      | Data[7]   | X       |   |
|                                      | Data[6]   | X       |   |
|                                      | Data[5]   | X       |   |
|                                      | Data[4]   | X       | Set to force current mode<br>2 $\mu$ A range has the minimum offset current |
|                                      | Data[3]   | 1       |   |
|                                      | Data[2:0] | 0XX     |   |

Step 3: Write to Register ADDR[4:0] = 0x0B (see Table 44).

**Table 44.**

| Register                       | Bit        | Setting | Comments  |
|--------------------------------|------------|---------|---|
| PMUDAC Level, ADDR[4:0] = 0x0B | Data[15:0] | X       | Update the PMUDAC level register to the desired value |

Step 4: Write to Register ADDR[4:0] = 0x0E (see Table 45).

**Table 45.**

| Register                             | Bit       | Setting | Comments  |
|--------------------------------------|-----------|---------|---|
| PMU State Register, ADDR[4:0] = 0x0E | Data[9:8] | 1X      | PMUDAC input selection  |
|                                      | Data[7]   | X       |   |
|                                      | Data[6]   | X       |   |
|                                      | Data[5]   | X       |   |
|                                      | Data[4]   | X       | Set to force current mode<br>Set to the desired current range |
|                                      | Data[3]   | 1       |   |
|                                      | Data[2:0] | XXX     |   |

# ADATE302-02

## Transition from PMU Force Current Mode to PMU Force Voltage Mode

Step 1: See Table 46 for state of registers in force current mode.

**Table 46.**

| Register                                 | Bits      | Setting |
|--|-----------|---------|
| PE/PMU Enable Register, ADDR[4:0] = 0x0C | Data[2]   | 1       |
| PMU State Register, ADDR[4:0] = 0x0E     | Data[9:8] | XX      |
|  | Data[7]   | X       |
|  | Data[6]   | X       |
|  | Data[5]   | X       |
|  | Data[4]   | X       |
|  | Data[3]   | 1       |
|  | Data[2:0] | XXX     |

Step 2: Write to Register ADDR[4:0] = 0x0E (see Table 47).

**Table 47.**

| Register                             | Bits      | Setting | Comments                         |
|--------------------------------------|-----------|---------|----------------------------------|
| PMU State Register, ADDR[4:0] = 0x0E | Data[9:8] | 00      | Set DUTGND input selection       |
|                                      | Data[7]   | X       |                                  |
|                                      | Data[6]   | X       |                                  |
|                                      | Data[5]   | X       |                                  |
|                                      | Data[4]   | X       |                                  |
|                                      | Data[3]   | 0       | Set to force voltage mode        |
|                                      | Data[2:0] | XXX     | Set to the desired current range |

Step 3: Write to Register ADDR[4:0] = 0x0B (see Table 48).

**Table 48.**

| Register                       | Bits       | Setting | Comments  |
|--------------------------------|------------|---------|---|
| PMUDAC Level, ADDR[4:0] = 0x0B | Data[15:0] | X       | Update the PMUDAC level register to the desired value |

Step 4: Write to Register ADDR[4:0] = 0x0E (see Table 49).

**Table 49.**

| Register                             | Bits      | Setting | Comments               |
|--------------------------------------|-----------|---------|------------------------|
| PMU State Register, ADDR[4:0] = 0x0E | Data[9:8] | 1X      | PMUDAC input selection |
|                                      | Data[7]   | X       |                        |
|                                      | Data[6]   | X       |                        |
|                                      | Data[5]   | X       |                        |
|                                      | Data[4]   | X       |                        |
|                                      | Data[3]   | 0       | Force voltage mode     |
|                                      | Data[2:0] | XXX     |                        |

BLOCK DIAGRAMS

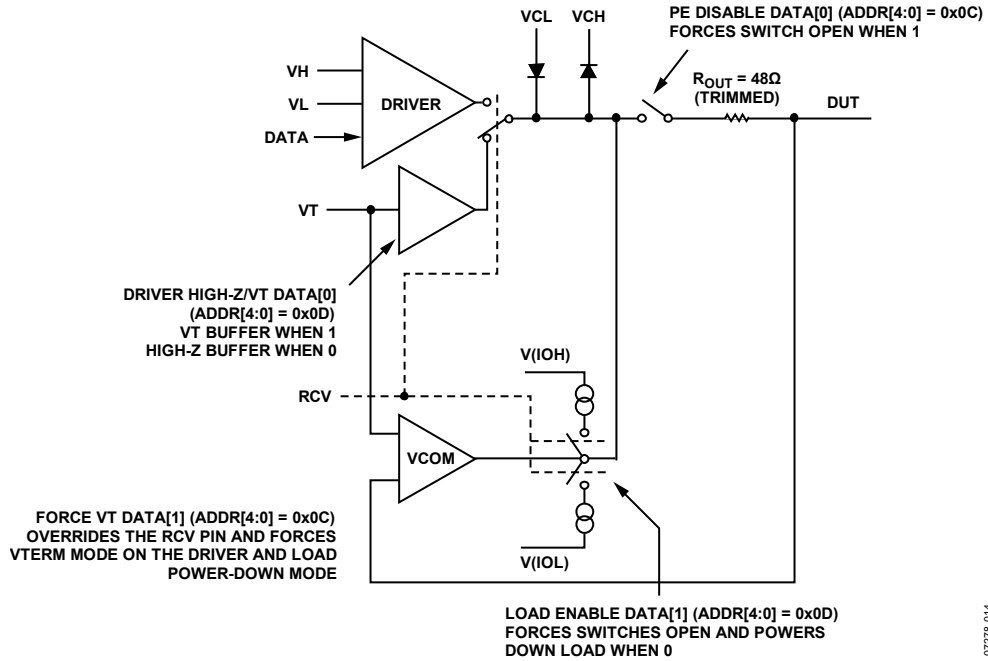

Figure 88. Driver and Load Block Diagram

07278-014

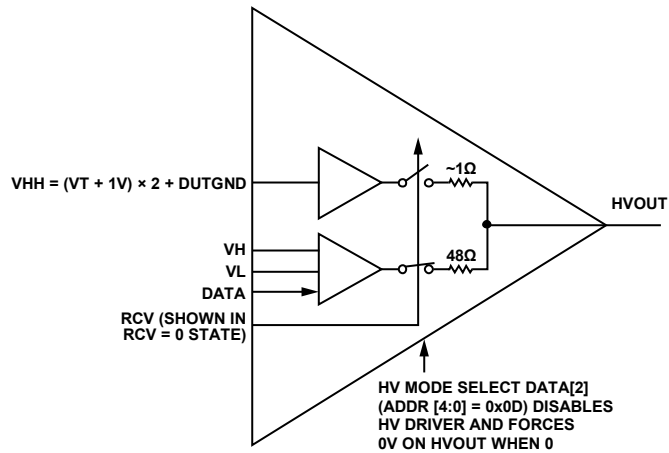
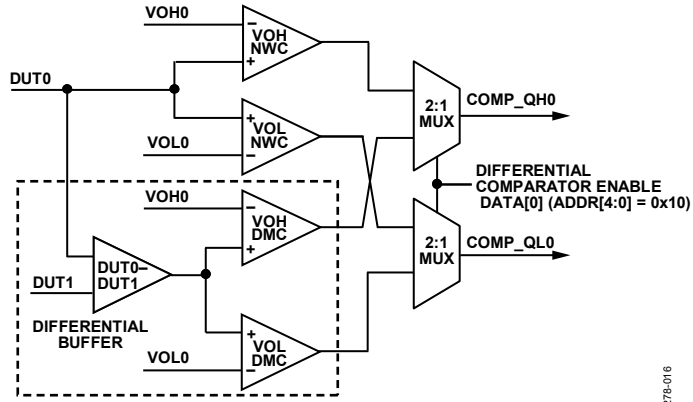

Figure 89. HVOUT Driver Output Stage

07278-015



NOTES  
1. DIFFERENTIAL COMPARATOR ONLY ON CHANNEL 0.

Figure 90. Comparator Block Diagram

07278-016

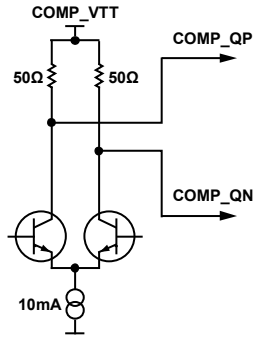
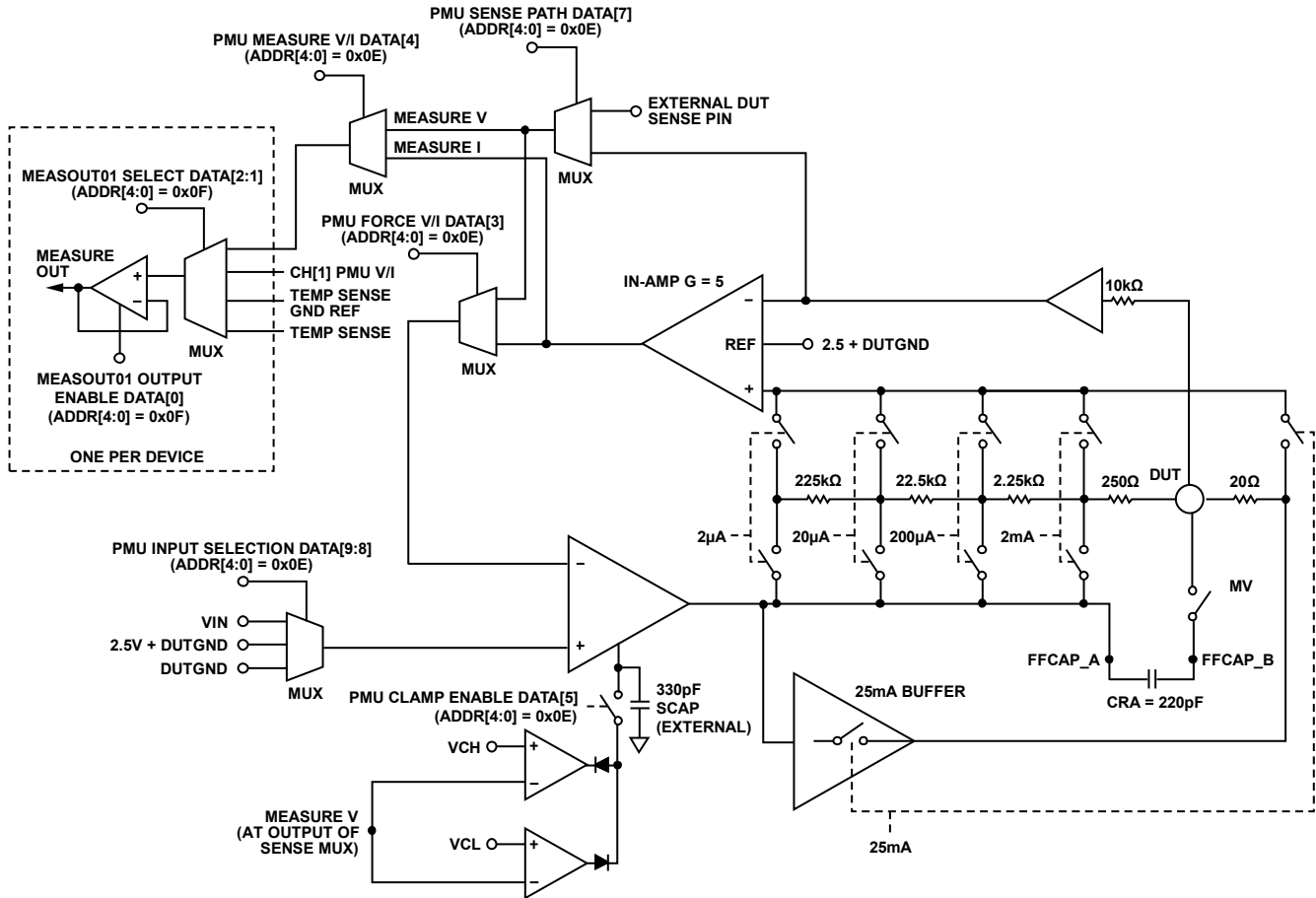

Figure 91. Comparator Output Scheme

07278-017



NOTES

1. SWITCHES CONNECTED WITH DOTTED LINES REPRESENT PMU RANGE DATA[2:0] (ADDR[4:0] = 0x0E); WHEN PMU ENABLE DATA[2] = 0 (ADDR[4:0] = 0x0C), ALL SWITCHES OPEN AND PMU POWERS DOWN.
2. THE EXTERNAL SENSE PATH MUST CLOSE THE LOOP TO ENABLE THE CLAMPS TO OPERATE CORRECTLY.
3. 25mA RANGE HAS ITS OWN OUTPUT BUFFER.
4. 25mA BUFFER WILL BE TRISTATED WHEN NOT IN USE.

Figure 92. PMU Block Diagram

07278-018

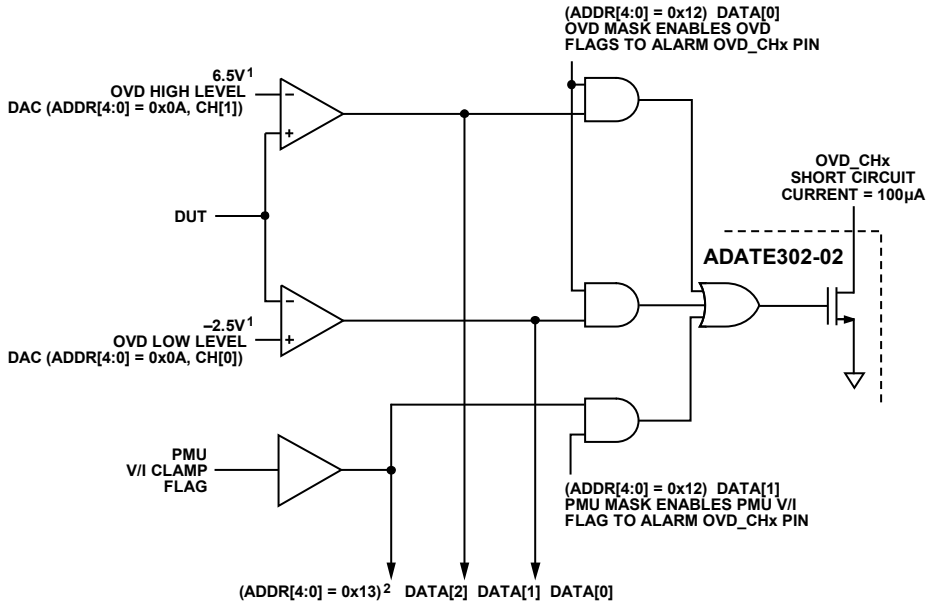

<sup>1</sup>THE OVD HIGH/LOW LEVEL DAC IS SHARED BY EACH CHANNEL; THEREFORE, ONLY ONE OVD HIGH/LOW VOLTAGE LEVEL CAN BE SET PER CHIP. THE OVD DACs PROVIDE A VOLTAGE RANGE OF -3V TO +7V. THE RECOMMENDED HIGH/LOW SETTINGS ARE +6.5V/-2.5V. (THESE VALUES NEED TO BE PROGRAMMED BY THE USER UPON STARTUP/RESET.)

<sup>2</sup>THIS IS A READ ONLY REGISTER THAT ALLOWS THE USER TO DETERMINE THE CAUSE OF THE ACTIVE OVD FLAG.

07278-019

Figure 93. OVD Block Diagram



OUTLINE DIMENSIONS

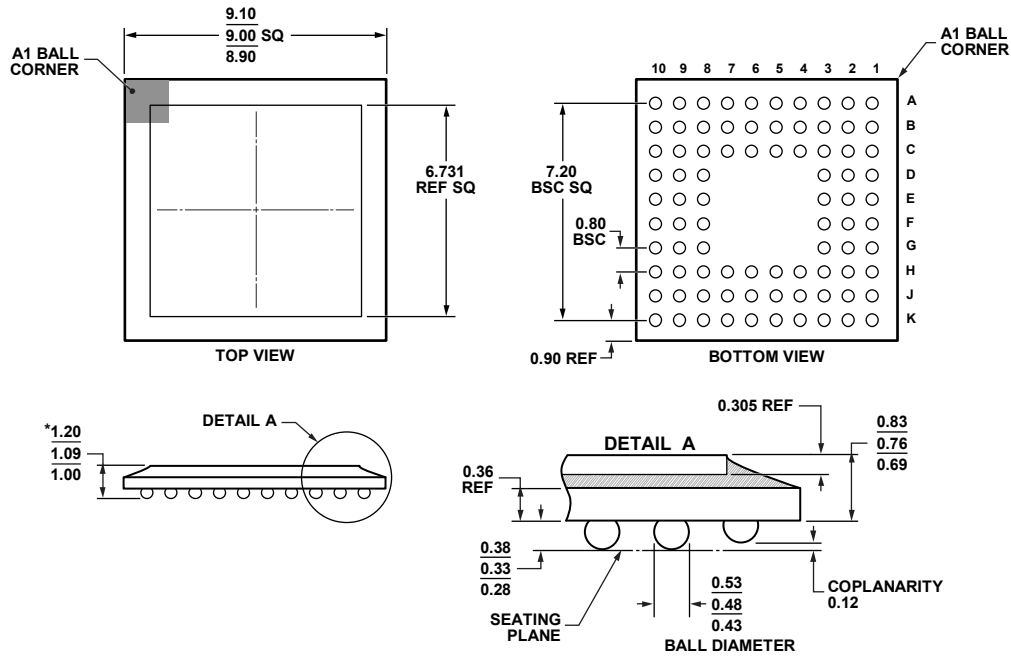

\*COMPLIANT TO JEDEC STANDARDS MO-219 WITH EXCEPTION TO PACKAGE HEIGHT.

Figure 94. 84-Ball Chip Scale Package Ball Grid Array [CSP\_BGA] (BC-84-2)

Dimensions shown in millimeters

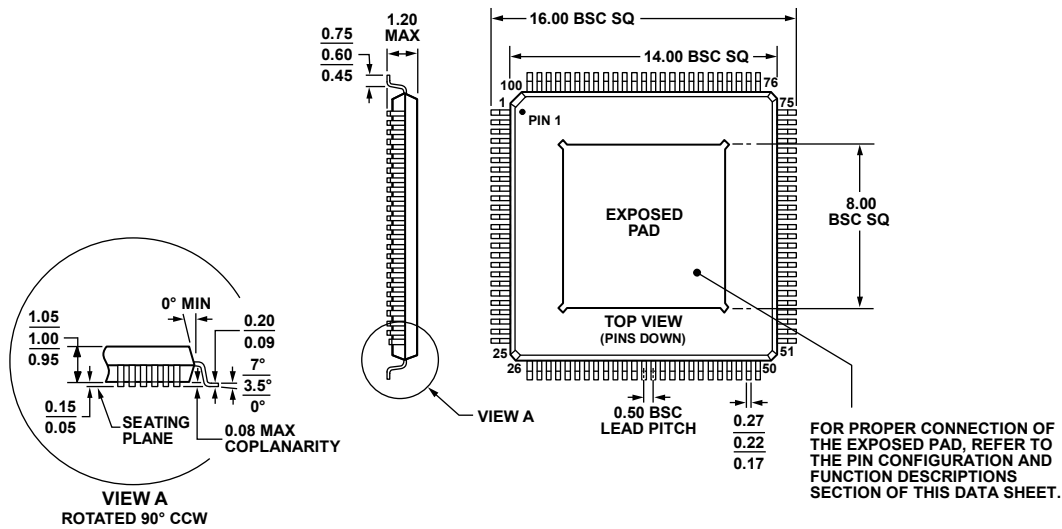

COMPLIANT TO JEDEC STANDARDS MS-026-AED-HU

Figure 95. 100-Lead Thin Quad Flatpack, Exposed Pad [TQFP\_EP] (SV-100-7)

Dimensions shown in millimeters

# A DATE302-02

## ORDERING GUIDE

| Model                         | Temperature Range | Package Description                                  | Package Option |
|-------------------------------|-------------------|--|----------------|
| A DATE302-02BBCZ <sup>1</sup> | -40°C to +85°C    | 84-Ball Chip Scale Package Ball Grid Array [CSP_BGA] | BC-84-2        |
| A DATE302-02BSVZ <sup>1</sup> | -40°C to +85°C    | 100-Lead Thin Quad Flatpack, Exposed Pad [TQFP_EP]   | SV-100-7       |

<sup>1</sup> Z = RoHS Compliant Part.

Компания «Океан Электроники» предлагает заключение долгосрочных отношений при поставках импортных электронных компонентов на взаимовыгодных условиях!

Наши преимущества:

- Поставка оригинальных импортных электронных компонентов напрямую с производств Америки, Европы и Азии, а так же с крупнейших складов мира;
- Широкая линейка поставок активных и пассивных импортных электронных компонентов (более 30 млн. наименований);
- Поставка сложных, дефицитных, либо снятых с производства позиций;
- Оперативные сроки поставки под заказ (от 5 рабочих дней);
- Экспресс доставка в любую точку России;
- Помощь Конструкторского Отдела и консультации квалифицированных инженеров;
- Техническая поддержка проекта, помощь в подборе аналогов, поставка прототипов;
- Поставка электронных компонентов под контролем ВП;
- Система менеджмента качества сертифицирована по Международному стандарту ISO 9001;
- При необходимости вся продукция военного и аэрокосмического назначения проходит испытания и сертификацию в лаборатории (по согласованию с заказчиком);
- Поставка специализированных компонентов военного и аэрокосмического уровня качества (Xilinx, Altera, Analog Devices, Intersil, Interpoint, Microsemi, Actel, Aeroflex, Peregrine, VPT, Syfer, Eurofarad, Texas Instruments, MS Kennedy, Miteq, Cobham, E2V, MA-COM, Hittite, Mini-Circuits, General Dynamics и др.);

Компания «Океан Электроники» является официальным дистрибьютором и эксклюзивным представителем в России одного из крупнейших производителей разъемов военного и аэрокосмического назначения «JONHON», а так же официальным дистрибьютором и эксклюзивным представителем в России производителя высокотехнологичных и надежных решений для передачи СВЧ сигналов «FORSTAR».



## JONHON

«JONHON» (основан в 1970 г.)

Разъемы специального, военного и аэрокосмического назначения:

(Применяются в военной, авиационной, аэрокосмической, морской, железнодорожной, горно- и нефтедобывающей отраслях промышленности)

«FORSTAR» (основан в 1998 г.)

ВЧ соединители, коаксиальные кабели,  
кабельные сборки и микроволновые компоненты:

(Применяются в телекоммуникациях гражданского и специального назначения, в средствах связи, РЛС, а так же военной, авиационной и аэрокосмической отраслях промышленности).



Телефон: 8 (812) 309-75-97 (многоканальный)

Факс: 8 (812) 320-03-32

Электронная почта: [ocean@oceanchips.ru](mailto:ocean@oceanchips.ru)

Web: <http://oceanchips.ru/>

Адрес: 198099, г. Санкт-Петербург, ул. Калинина, д. 2, корп. 4, лит. А