



FEATURES

- Efficiency up to 90.0% @72Vin 12Vout
- Ultra wide input range, 16.8V-137.5V
- 14.4V/1S, 200V/1S transient voltage
- Package with Industry Standard Pinout
- Package Dimension: 63.1mm*60.6mm*13mm(2.49"*2.39"*0.51")
- OUTPUT OVP,OCP(hiccup) OTP(auto recovery)
- Positive or Negative Remote ON/OFF
- Without tantalum capacitor inside module
- Operating Base plate Temperature range - 40°C to +100°C
- 4242VDC input to output reinforced isolation
- Unit operation monitor PIN option
- A fixed frequency pulse PIN option
- Hold up time PIN option
- UVLO set up PIN option
- RoHs Compliant
- 5 Years Product Warranty
- Heat-sink is option
- Meet requirements of EN50155
- UL60950-1, 2nd Edition (pending)

Delphi Series H80SV, Half Brick Family DC/DC Power Modules: 16.8~137.5 Vin, 54/48/24/15/12Vout,200W

The H80SV series Half-Brick is isolated 100W DC/DC converters with 4242VDC isolation. The H80SV family comes with a host of industry-standard features, such as over current protection, over voltage protection, over temperature protection and remote on/off. All models have an ultra-wide 8:1 input voltage range (16.8V to 137.5V). With operating temperature of -40°C to +85°C, it is suitable for customers' critical applications, such as process control and automation, transportation, data communication and telecom equipment, test equipment, medical device and everywhere where space on the PCB is critical.

APPLICATIONS

- Railway /Transportation system

SIMPLIFIED APPLICATION CIRCUIT

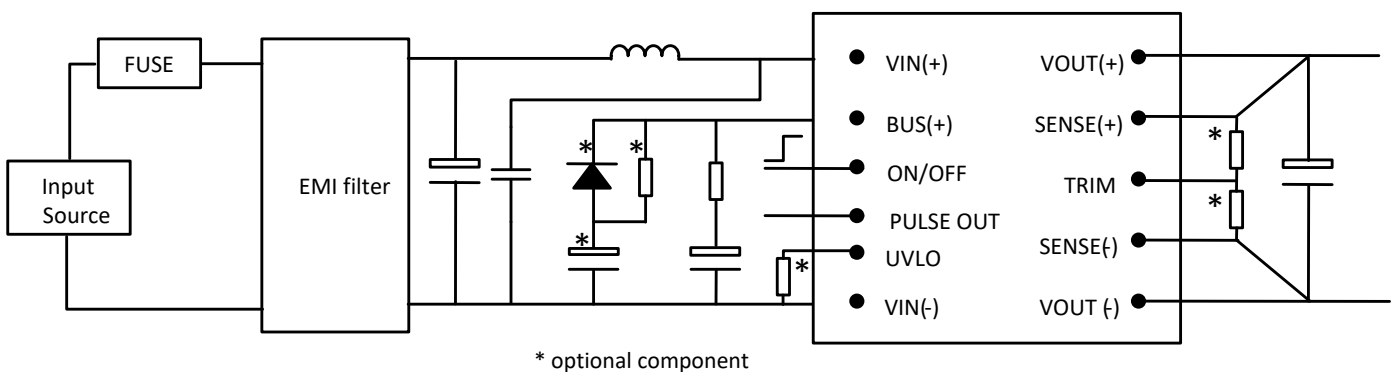

TECHNICAL SPECIFICATION

PARAMETER	NOTES and CONDITIONS	H80SV12008			
		Min.	Typ.	Max.	Units
1. ABSOLUTE MAXIMUM RATINGS					
1.1 Input Voltage	Non-operating			200	Vdc
1.2 Operating Temperature	Ambient temperature	-40		85	°C
	Baseplate temperature	-40		100	°C
1.3 Storage Temperature		-40		125	°C
1.4 Operating Altitude				5000	m
1.5 Operating Humidity		5		95	%rh
2. INPUT CHARACTERISTICS					
2.1 Operating Input Voltage	continuously	16.8	72	137.5	Vdc
	<1s			200	Vdc
2.2 Input Under-Voltage Lockout	UVLO external resistor open				
2.2.1 Turn-On Voltage Threshold		15.6	16.0	16.4	Vdc
2.2.2 Turn-Off Voltage Threshold		13.6	14.0	14.4	Vdc
2.3 Maximum Input Current	Full Load, Vin=16.8V		7	7.5	A
2.4 No-Load Input Current	Vin=72, Io=0A	30	60	90	mA
2.6 Off Converter Input Current	Vin=72V			30	mA
3. OUTPUT CHARACTERISTICS					
3.1 Output Voltage Set Point	Vin=72V, Io=0, Tc=25°C	11.88	12.00	12.12	Vdc
3.1.1 Load regulation	Vin=72V, Io=Io min to Io max		±0.05	±0.2	%
3.1.2 Line regulation	Vin=16.8V to 137.5V, Io=full load		±0.01	±0.2	%
3.1.3 Temperature regulation	Vin=72V, Tc= min to max case temperature		±0.004	±0.007	%/°C
3.1.4 Total output voltage range	Over sample, line, load, temperature, life	-2.5		+2.5	%
3.2 Output Voltage Ripple and Noise	5Hz to 20MHz bandwidth				
3.2.1 Peak-to-Peak	Vin=72V, Full Load,		30		mV
3.2.2 rms	Vin=72V, Full Load,		8		mV
3.3 Operating Output Current Range				8	A
3.4 Output DC Current-Limit Inception		10		24	A
4. DYNAMIC CHARACTERISTICS					
4.1 Output Voltage Current Transient	Vin=72V, 0.1A/μs				
4.1.1 Positive Step Change in Output Current	50% Io,max to 75%		280		mV
4.1.2 Negative Step Change in Output Current	75% Io,max to 50%		280		mV
4.2 Turn-On Transient					
4.2.1 Start-Up Time, From On/Off Control		200		460	ms
4.2.2 Start-Up Time, From Input		200		460	ms
4.2.3 Rise time (Vout from 10% to 90%)				100	ms
4.4 output capacitor				2200	μF
5. EFFICIENCY					
5.1 100% Load	Vin=72V		90.0		%
5.2 60% Load	Vin=72V		87.0		%
6. ISOLATION CHARACTERISTICS					
6.1 Input to Output				4242	Vdc
6.2 Input to base				4242	Vdc
6.3 Output to base				4242	Vdc
6.4 Isolation Resistance		10			MΩ
7. FEATURE CHARACTERISTICS					
7.1 Switching Frequency			140		kHz
7.2 ON/OFF Control	Positive or Negative logic optional				
7.2.1 Positive Remote On/Off Logic	ON/OFF pin floating, module ON				
7.2.1.1 Logic High (Module On)		3		5	V
7.2.1.2 Logic Low (Module Off)		0		0.4	V
7.2.2 Negative Remote On/Off Logic	ON/OFF pin floating, module OFF				
7.2.2.1 Logic Low (Module On)		0		0.4	V
7.2.2.2 Logic High (Module Off)		3		5	V
7.3 Output Voltage Trim Range		-20		10	%
7.4 Output Over-Voltage Protection	Over full temp range; % of nominal Vout	110	120	130	%
8 GENERAL SPECIFICATIONS					
8.1 MTBF			1.48		10 ⁶ hours
8.2 Weight	With heat spreader		125		grams
8.3 Over-Temperature Shutdown (NTC resistor)			125		°C
8.4 Over-Temperature Shutdown Restart Hysteresis			6		°C
8.5 Thermal Impedance	Vin=24V, full load, component to baseplate		0.77		K/W
	Vin=48V, full load, component to baseplate		0.85		K/W
	Vin=72V, full load, component to baseplate		0.99		K/W
	Vin=110V, full load, component to baseplate		1.05		K/W

ELECTRICAL CHARACTERISTICS CURVES

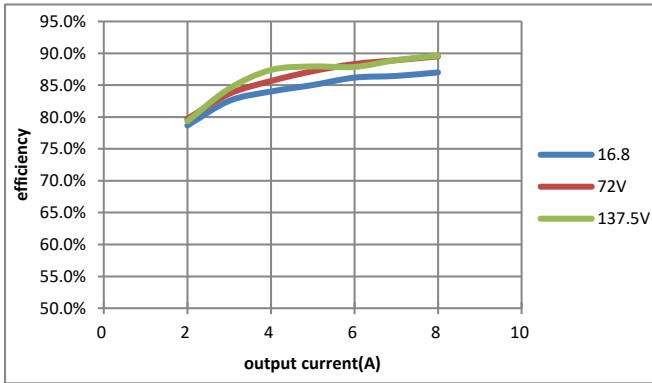

Figure 1: Efficiency vs. load current for 16.8, 72V and 137.5V input voltage at 25°C.

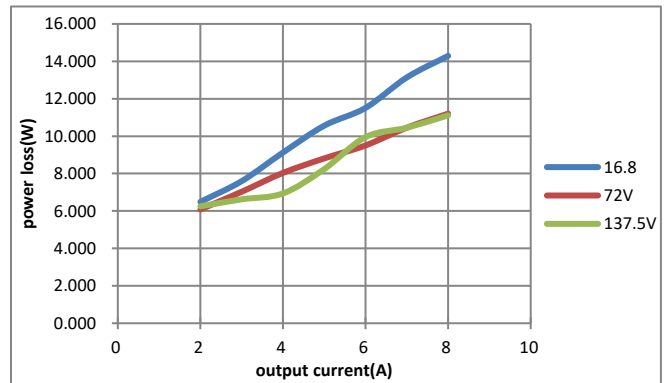

Figure 2: Power loss vs. load current for 16.8, 72V and 137.5V input voltage at 25°C.

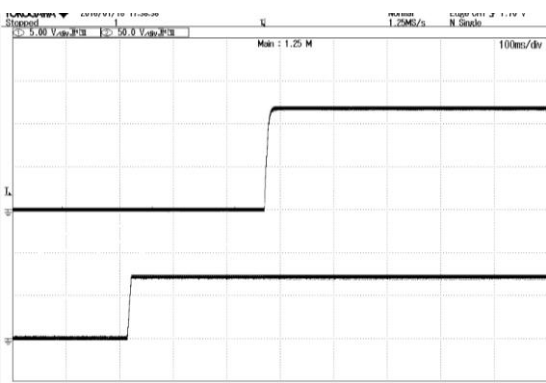

Figure 3: Turn-on transient at full load current (100ms/div). Top Trace: Vout: 5V/div; Bottom Trace: Vin: 50V/div

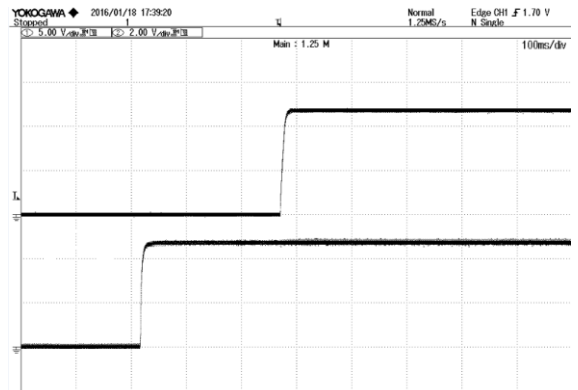

Figure 4: Turn-on transient at full load current (100ms/div). Top Trace: Vout: 5V/div; Bottom Trace: ON/OFF: 2V/div

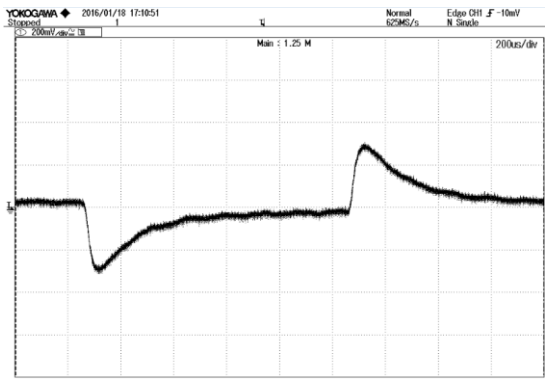

Figure 5: Output voltage response to step-change in load current (50%-75%-50% of full load; $di/dt = 0.1A/\mu s$). Trace: Vout; 200mV/div; Time: 200us/div

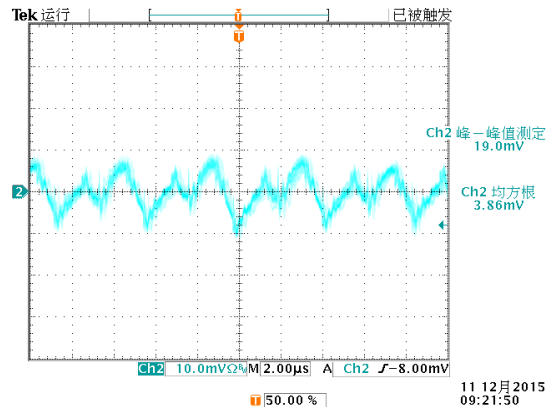

Figure 6: Output voltage ripple at $V_{in}=72V$ and full load (20mV/div, 2us/div) Bandwidth: 20 MHz.

FEATURE DESCRIPTION

Over-Current Protection

The modules include an internal output over-current protection circuit, which will endure current limiting for an unlimited duration during output overload. If the output current exceeds the OCP set point, the module will shut down, and always try to restart (hiccup mode) until the over current condition is corrected.

Over-Voltage Protection

The modules include an internal output over-voltage protection circuit, which monitors the voltage on the output terminals. If this voltage exceeds the over-voltage set point, the module will shut down, and always try to restart until the over current condition is corrected.

Over-Temperature Protection

The over-temperature protection consists of circuitry that provides protection from thermal damage. If the over-temperature is detected the module will shut down, and restart after the temperature is within specification.

Remote ON/OFF

The remote on/off feature on the module can be either negative or positive logic. Negative logic turns the module on during logic low and off during logic high. Positive logic turns the modules on during logic high and off during a logic low.

Remote on/off can be controlled by an external switch between the on/off terminal and the Vin (-) terminal. The switch can be an open collector or open drain. For negative logic if the remote on/off feature is not used, please short the on/off pin to Vin (-). For positive logic if the remote on/off feature is not used, please leave the on/off pin to floating.

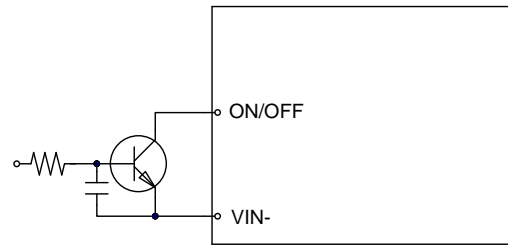

Figure 7 : Remote ON/OFF Implementation

PULSE OUT

This pin outputs a 1KHz 50% duty cycle pulse voltage with 12V amplitude. It is designed to provide a bootstrap signal for the input inrush current limit circuit, and also could indicate operating status with a LED connected. if you don't need it, please let it open.

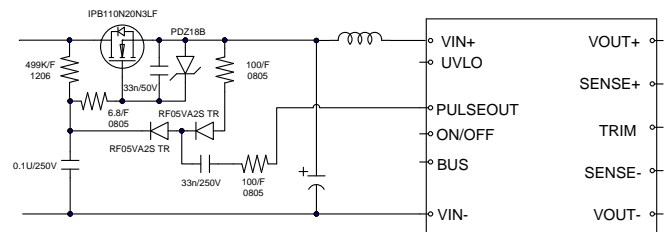

Figure 8: An Active Circuit Design For Inrush Current Limit

UVLO.

H80SV Series converters have an under voltage lockout feature that will shut down the converter if the input voltage falls below the adjustable threshold. Devices will automatically restart when input voltage rises above the UVLO threshold. The hysteresis built into this function prevents an indeterminate on/off condition at a single input voltage. The under voltage threshold is determined by the value of a resistor placed between the UVLO and VIN (-). Figure 9 shows a typical configuration.

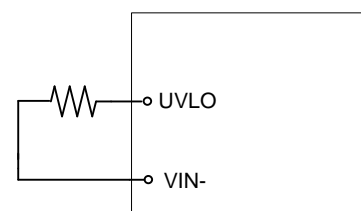

Figure 9: Under voltage Lockout Configuration

The table below shows UVLO values for various nominal input voltages and the required resistor.

Nominal Vin	24V		36V	48V	72V	96V	110V
Turn-off Threshold	12.0±0.4V	14.0±0.4V	21.2	28.4	42.8	57.2	65.6
			±0.4V	±0.4V	±1V	±1V	±2V
Turn-on Threshold	14.0±0.4V	16.0±0.4V	24.5	33.6	50.4	67.6	76.8
			±0.4V	±0.4V	±1V	±1V	±2V
UVLO External Resistor (KΩ)*	2.2Meg	open	24.9	12.4	6.19	4.12	3.48
	(UVLO to Vin+)						

Note: if need to configure UVLO turn off threshold to 12V, please make sure the output power is no more than 120w, even though the 12V operating is short duration.

Otherwise the input current maybe over spec and cause some issue.

Hold up time

Hold up time is defined as the duration of time that the DC/DC converter output will remain active following a loss of input power. The BUS+ pin is for hold-up time function. It is designed to work with an external circuit comprises C4, R4, D1. When input power supply is interrupt, the H80 DCDC use the energy stored in C4 to support operation. A typical configuration shows as Figure 10.

R4: 100ohm,KNP100JT-73100R/YAGEO

D1: 200V/3A,

If hold-up time function is not needed, just leave the 3 components open.

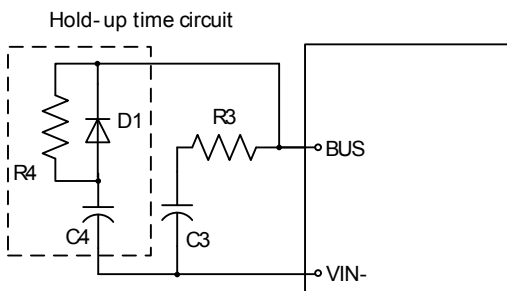

Figure 10: Connection of External Hold-up Circuit

This function provides energy that maintains the DC-DC converter in operation for 10mS of hold up

time. The capacity in the application is recommended as below.

Capacitance	24V	36V	48V	72V	96V	110V
For 10 mS	2400uF	2400uF	2400uF	2400uF	820uF	560uF
For 30 mS	7200uF	7200uF	7200uF	7200uF	2460uF	1680uF

The voltage BUS+ varies with input voltage and the relationship is showed in figure11. The red curve, BUS(+) keeps stable at 80V(80V~90V) when input voltage rise from 16.8V to 75V, when the input voltage is above 75V, then BUS(+) follows input voltage. The blue one, BUS(+) falls with input voltage until the input voltage falls to 72V(72V~80V), then BUS(+) will maintain 80V until input voltage falls below the UVLO.

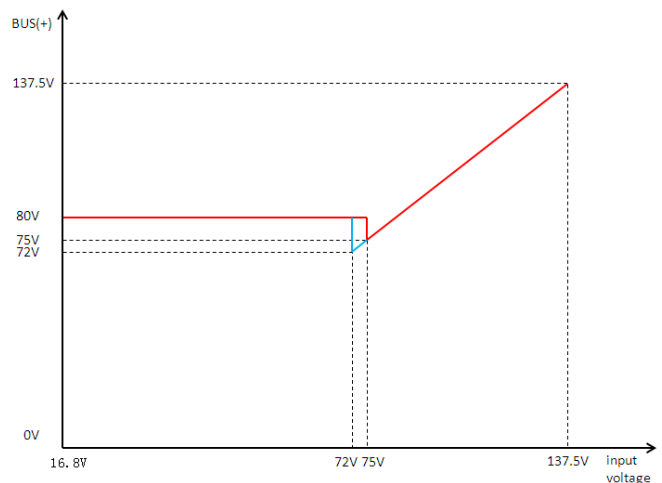

Figure 11: BUS(+) VS Input Voltage

Note: for the rated voltage of capacitor please refer to the BUS+ voltage curve showed in figure 11.

Output Voltage Adjustment (TRIM)

To increase or decrease the output voltage set point, connect an external resistor between the TRIM pin and SENSE (+) pin or SENSE (-) pin. The TRIM pin should be left open if this feature is not used.

For trim down, the external resistor value required to obtain a percentage of output voltage change Δ is

defined as:

$$R_{trim-down} = \left[\frac{5.11}{\Delta} - 10.22 \right] (k\Omega)$$

Ex. When Trim-down -10% (12V×0.9=10.8V)

$$R_{trim-down} = \left[\frac{5.11}{10\%} - 10.22 \right] (k\Omega) = 40.88 (k\Omega)$$

For trim up, the external resistor value required to obtain a percentage output voltage change Δ is defined as:

$$R_{trim-up} = \left[\frac{45}{\Delta} + 40 \right] k\Omega$$

Ex. When Trim-up +10% (12V×110%=13.2V)

$$R_{trim-up} = \left[\frac{45}{10\%} + 40 \right] = 490 (k\Omega)$$

DESIGN CONSIDERATIONS

Input Source Impedance

C1:1UF MLCC or film cap, placed as close to module as possible

C2:100UF ALCAP

L1:3.3uH inductor, depress the ripple current flow into C2

For better EMC performance, it is recommended that C2 be parallel connected with MLCC 1UF like C3

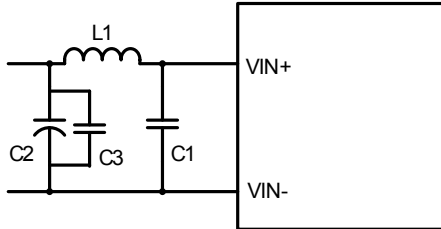

Figure 12 input filter design

Bus Cap and Resistor

An electrolytic cap (C3) at least 200uF and a resistor (R3) 3ohm connected between bus+ and Vin- is necessary. The cap provides/absorb transient power and make the DCDC operating stable. The series resistor R3 is recommended to depress the high frequency ripple current flow into C3.

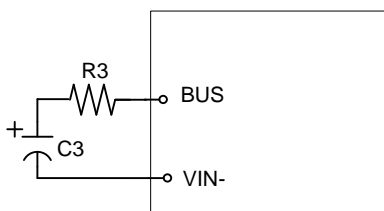

Figure 13 BUS pin circuit

Safety Considerations

The power module must be installed in compliance with the spacing and separation requirements of the end-user's safety agency standard, i.e., UL 60950-1, 2nd Edition, 2014-10-14, CSA C22.2 No. 60950-1-07, 2nd Edition, 2014-10, IEC 60950-1: 2005 + A1: 2009 + A2: 2013 and EN 60950-1: 2006 + A11: 2009 + A1: 2010 + A12: 2011 + A2: 2013, if the system in which the power module is to be used must meet safety agency requirements.

Reinforced insulation is provided between the input and output of the module. Input is considered as secondary hazardous voltage which main transient is up to 1500Vpk and output is considered as SELV circuit. The input source must be insulated from the ac mains by reinforced or double insulation. The input terminals of the module are not considered as operator accessible.

A SELV reliability test may require when install on the system where the module is used, in combination with the module, to ensure that under a single fault, hazardous voltage does not appear at the module's output.

Soldering and Cleaning Considerations

Post solder cleaning is usually the final board assembly process before the board or system undergoes electrical testing. Inadequate cleaning and/or drying may lower the reliability of a power module and severely affect the finished circuit board assembly test. Adequate cleaning and/or drying is especially important for un-encapsulated and/or open frame type power modules. For assistance on appropriate soldering and cleaning procedures, please contact Delta's technical support team.

EMC CIRCUIT

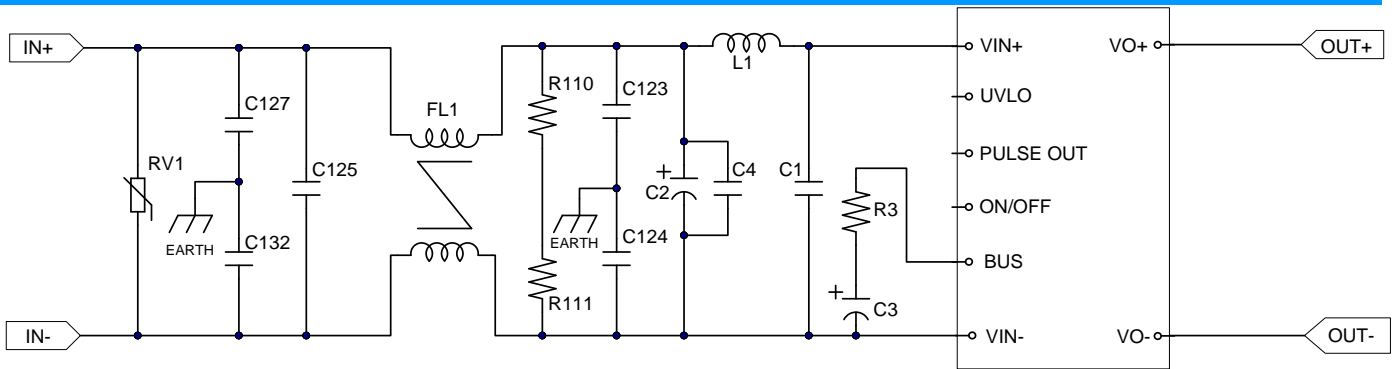

Figure 14 input filter design for EN50155

ID	PART NO.	TYPE	PARAMETERS	QTY	VENDOR
RV1 (MOV)	B72207S0131K101	Varistor	170VDC,1.2KA	1	EPCOS
C123, C124, C127, C132	R413F1100JU00M	Capacitor,Y2/X1	1000p,300VAC	4	KEMET
C125	R46KF310045M1M	Capacitor,X2	0.1uF,275VAC	1	KEMET
FL1	PH9455.105NL	Common choke	1mH	1	Pulse
R110,R111	RV1206FR-07100K	1206 1/4W	100k ohm	2	YAGEO
C1	C1210X474K251TX	MLCC	0.47uF/250V(2pcs parallel)	2	HOLY STONE
C4	C1210X474K251TX	MLCC	0.47uF/250V(2pcs parallel)	2	HOLY STONE
C2	EKXG201ELL101ML20S	Capacitor, Electrolytic	100uF,200V	1	NCC
C3	EKXJ251EC3121ML25S	Capacitor, Electrolytic	120uF,250V(2pcs parallel)	2	NCC
R3	PNP100JT-52 3R	RES WW 1W 3ohm J FR SMALL	3.01 ohm/1W	1	YAGEO
L1	CMLS104T-3R3MS	choke	3uH	1	Cyntec

THERMAL CONSIDERATIONS

The thermal curve is based on the test setup shown as figure13. The module is mounted on an Al plate and was cooled by cooling liquid.

Figure14 shows the location to monitor the temperature of the module's baseplate. The baseplate temperature in thermal curve is a reference for customer to make thermal evaluation and make sure the module is operated under allowable temperature. (Thermal curves shown in Figure15 are based on different input voltage).

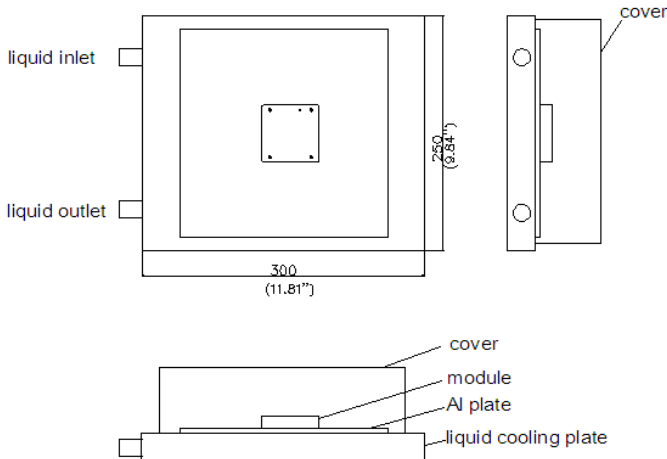

Figure 13: Test setup

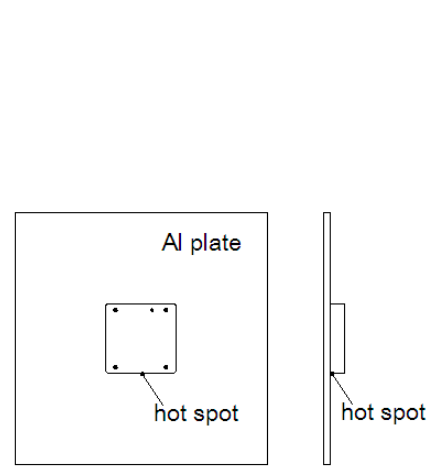

Figure 14: Temperature measured point

THERMAL CURVES

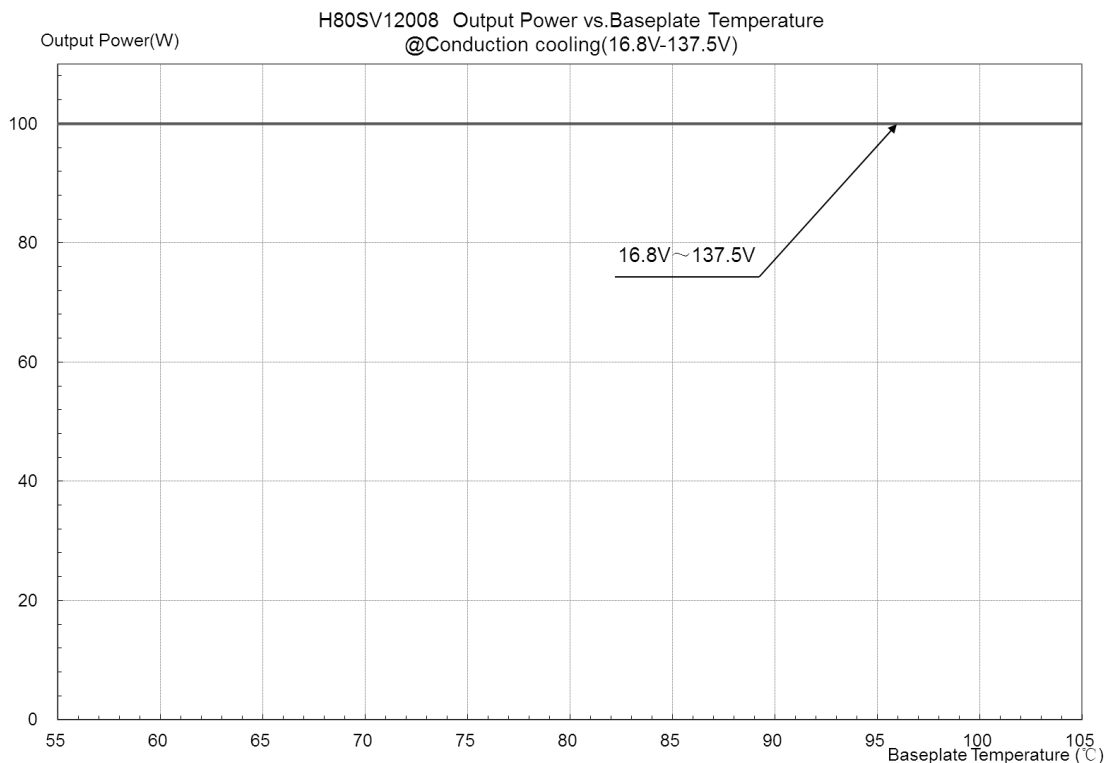
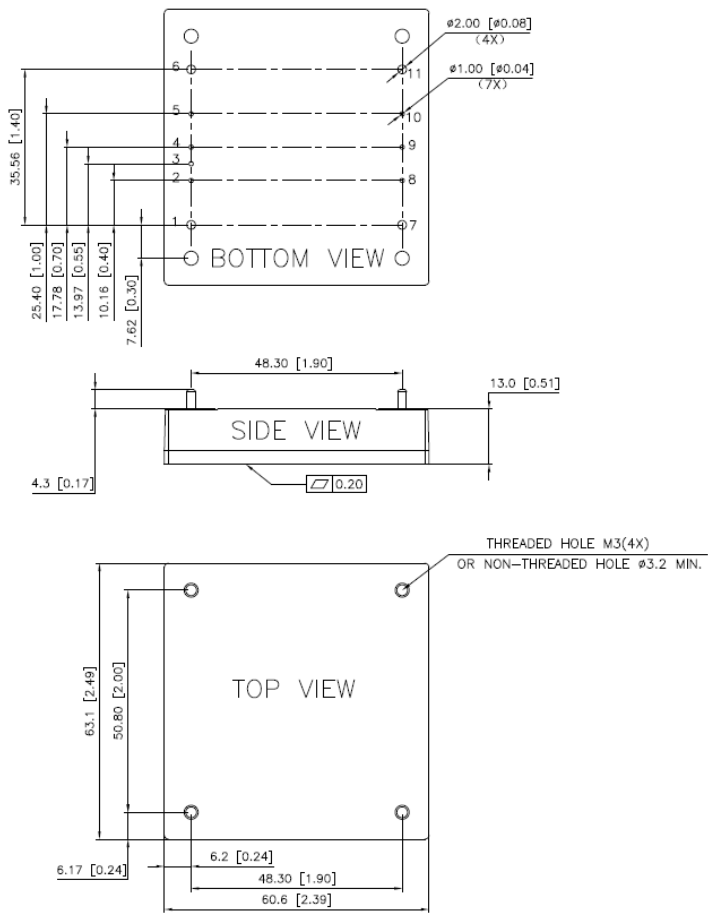

Figure 15: Output Power vs Baseplate temperature @Vin=16.8V~137.5 V

MECHANICAL DRAWING(BASEPLATE)



PIN #	FUNCTION
1	Vin+
2	UVLO
3	PULSE OUT
4	ON/OFF
5	BUS
6	Vin-
7	Vout+
8	Sense+
9	Trim
10	Sense-
11	Vout-

All dimensions in mm (inches)
Tolerance: X.X \pm 0.5 (X.XX \pm 0.02)
X.XX \pm 0.25 (X.XXX \pm 0.010)

Figure 16: The pin function and mechanical drawing



PART NUMBERING SYSTEM

H	80	S	V	12	008	P	R	F	S
Form Factor	Input Voltage	Number of Outputs	Product Series	Output Voltage	Output Current	ON/OFF Logic	Pin Length		Option Code
H - Half Brick	80 -16.8 ~137.5V	S - Single	V - Series Number	12 - 12V	008 - 8A	N - Negative P - Positive	N - 0.145" R - 0.170"	F - RoHS 6/6 (Lead Free) Space - RoHS5/6	A - Through Hole S - Screw Hole(M3*0.5)

RECOMMENDED PART NUMBER

MODEL NAME	INPUT	OUTPUT	EFF @ 100% LOAD
H80SV12008PRFS	16.8V~137.5V	7.5A	90.0%

Default remote on/off logic is negative and pin length is 0.170"

For different remote on/off logic and pin length, please refer to part numbering system above or contact your local sales office.

For modules with through-hole pins and the optional heat-spreader, they are intended for wave soldering assembly onto system boards; please do not subject such modules through reflow temperature profile.

CONTACT: www.deltaww.com/dcdc

USA:

Telephone:
East Coast: 978-656-3993
West Coast: 510-668-5100
Fax: (978) 656 3964

Email: dcdc@deltaww.com

Europe:

Phone: +31-20-655-0967
Fax: +31-20-655-0999

Asia & the rest of world:

Telephone: +886 3 4526107
ext 6220~6226
Fax: +886 3 4513485

WARRANTY

Delta offers a five (5) year limited warranty. Complete warranty information is listed on our web site or is available upon request from Delta.

Information furnished by Delta is believed to be accurate and reliable. However, no responsibility is assumed by Delta for its use, nor for any infringements of patents or other rights of third parties, which may result from its use. No license is granted by implication or otherwise under any patent or patent rights of Delta. Delta reserves the right to revise these specifications at any time, without notice.

Компания «Океан Электроники» предлагает заключение долгосрочных отношений при поставках импортных электронных компонентов на взаимовыгодных условиях!

Наши преимущества:

- Поставка оригинальных импортных электронных компонентов напрямую с производств Америки, Европы и Азии, а так же с крупнейших складов мира;
- Широкая линейка поставок активных и пассивных импортных электронных компонентов (более 30 млн. наименований);
- Поставка сложных, дефицитных, либо снятых с производства позиций;
- Оперативные сроки поставки под заказ (от 5 рабочих дней);
- Экспресс доставка в любую точку России;
- Помощь Конструкторского Отдела и консультации квалифицированных инженеров;
- Техническая поддержка проекта, помощь в подборе аналогов, поставка прототипов;
- Поставка электронных компонентов под контролем ВП;
- Система менеджмента качества сертифицирована по Международному стандарту ISO 9001;
- При необходимости вся продукция военного и аэрокосмического назначения проходит испытания и сертификацию в лаборатории (по согласованию с заказчиком);
- Поставка специализированных компонентов военного и аэрокосмического уровня качества (Xilinx, Altera, Analog Devices, Intersil, Interpoint, Microsemi, Actel, Aeroflex, Peregrine, VPT, Syfer, Eurofarad, Texas Instruments, MS Kennedy, Miteq, Cobham, E2V, MA-COM, Hittite, Mini-Circuits, General Dynamics и др.);

Компания «Океан Электроники» является официальным дистрибьютором и эксклюзивным представителем в России одного из крупнейших производителей разъемов военного и аэрокосмического назначения «JONHON», а так же официальным дистрибьютором и эксклюзивным представителем в России производителя высокотехнологичных и надежных решений для передачи СВЧ сигналов «FORSTAR».



JONHON

«JONHON» (основан в 1970 г.)

Разъемы специального, военного и аэрокосмического назначения:

(Применяются в военной, авиационной, аэрокосмической, морской, железнодорожной, горно- и нефтедобывающей отраслях промышленности)

«FORSTAR» (основан в 1998 г.)

ВЧ соединители, коаксиальные кабели, кабельные сборки и микроволновые компоненты:

(Применяются в телекоммуникациях гражданского и специального назначения, в средствах связи, РЛС, а так же военной, авиационной и аэрокосмической отраслях промышленности).



Телефон: 8 (812) 309-75-97 (многоканальный)

Факс: 8 (812) 320-03-32

Электронная почта: ocean@oceanchips.ru

Web: <http://oceanchips.ru/>

Адрес: 198099, г. Санкт-Петербург, ул. Калинина, д. 2, корп. 4, лит. А