

Cree® PLCC6 3 in 1 SMD LED SLV6D-FKB

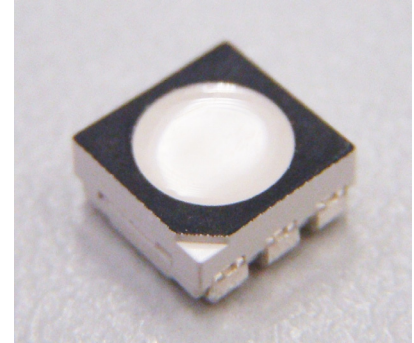

PRODUCT DESCRIPTION

These SMD LEDs are packaged in an industry standard PLCC6 package.

These high performance tricolor SMT LEDs are designed to work in a wide range of applications. A wide viewing angle and high brightness make these LEDs suitable for various full color applications.

The encapsulation resin contains UV inhibitors to minimize the effects of long-term exposure to direct sunlight, resulting in stable light output over the life of the LED.

FEATURES

- Size (mm): 5.5 x 5.5
- Dominant Wavelength:
Red (619 - 624nm)
Green (520 - 540nm)
Blue (460 - 480nm)
- Luminous Intensity (mcd)
Red (560 - 1120)
Green (900 - 1800)
Blue (180 - 450)
- Moisture Sensitivity Level: 5a
- Lead-Free
- RoHS Compliant
- Matte Surface

APPLICATIONS

- Decorative lighting
- Amusement

*: This part is tested under the condition of assembling it on a PCB with isolating the electrical path by silicone. The leads area of the LED is not IPx8 rated and it's required to insulate for moisture by customer in outdoor application.

ABSOLUTE MAXIMUM RATINGS ($T_A = 25^\circ\text{C}$)

| Items | Symbol | Absolute Maximum Rating | | | Unit |
|--|------------|-------------------------|-----|-----|---------------------------|
| | | R | G | B | |
| Forward Current ^{Note 1} | I_F | 50 | 35 | 35 | mA |
| Peak Forward Current ^{Note 2} | I_{FP} | 200 | 100 | 100 | mA |
| Reverse Voltage | V_R | 5 | 5 | 5 | V |
| Power Dissipation | P_D | 125 | 126 | 133 | mW |
| Operation Temperature | T_{opr} | -40 ~ +100 | | | $^\circ\text{C}$ |
| Storage Temperature | T_{stg} | -40 ~ +100 | | | $^\circ\text{C}$ |
| Junction Temperature | T_j | 110 | 110 | 110 | $^\circ\text{C}$ |
| Junction/ambient 1 chip on | R_{THJA} | 450 | 400 | 450 | $^\circ\text{C}/\text{W}$ |
| Junction/ambient 3 chips on | R_{THJA} | 650 | 580 | 680 | $^\circ\text{C}/\text{W}$ |
| Junction/solder point 1 chip on | R_{THJS} | 230 | 230 | 200 | $^\circ\text{C}/\text{W}$ |
| Junction/solder point 3 chips on | R_{THJS} | 230 | 230 | 200 | $^\circ\text{C}/\text{W}$ |
| Electrostatic Discharge Classification(MIL-STD-883E) | ESD | 1000 V | | | |

Note: 1.Single-color light.
2.Pulse width ≤ 0.1 msec, duty $\leq 1/10$.

TYPICAL ELECTRICAL & OPTICAL CHARACTERISTICS ($T_A = 25^\circ\text{C}$)

| Characteristics | Condition | Symbol | Values | | | Unit |
|---|--|------------------|---------|---------|---------|---------------|
| | | | R | G | B | |
| Dominant Wavelength | $I_F = 15$ mA(R) $I_F = 10$ mA(G) $I_F = 10$ mA(B) | λ_{DOM} | 619~624 | 520~540 | 460~480 | nm |
| Spectral bandwidth at 50% I_{REL} max | $I_F = 15$ mA(R) $I_F = 10$ mA(G) $I_F = 10$ mA(B) | $\Delta \lambda$ | 24 | 38 | 28 | nm |
| Forward Voltage | $I_F = 15$ mA(R) $I_F = 10$ mA(G) $I_F = 10$ mA(B) | $V_{F(avg)}$ | 2.0 | 2.8 | 3.0 | V |
| | | $V_{F(max)}$ | 2.5 | 3.6 | 3.8 | V |
| Luminous Intensity | $I_F = 15$ mA(R) $I_F = 10$ mA(G) $I_F = 10$ mA(B) | $I_{V(min)}$ | 560 | 900 | 180 | mcd |
| | | $I_{V(avg)}$ | 780 | 1200 | 280 | mcd |
| Reverse Current (max) | $V_R = 5$ V | I_R | 10 | 10 | 10 | μA |

Note: Continuous reverse voltage can cause LED damage.

INTENSITY BIN LIMIT (RED $I_f = 15$ mA, GREEN $I_f = 10$ mA, BLUE $I_f = 10$ mA)

Red

| Bin Code | Min.(mcd) | Max.(mcd) |
|----------|-----------|-----------|
| K | 560 | 710 |
| np | 635 | 805 |
| M | 710 | 900 |
| qr | 805 | 1010 |
| N | 900 | 1120 |

Green

| Bin Code | Min.(mcd) | Max.(mcd) |
|----------|-----------|-----------|
| N | 900 | 1120 |
| st | 1010 | 1260 |
| P | 1120 | 1400 |
| vw | 1260 | 1600 |
| Q | 1400 | 1800 |

Blue

| Bin Code | Min.(mcd) | Max.(mcd) |
|----------|-----------|-----------|
| E | 180 | 224 |
| bc | 202 | 252 |
| F | 224 | 280 |
| de | 252 | 318 |
| G | 280 | 355 |
| fg | 318 | 403 |
| H | 355 | 450 |

Tolerance of measurement of luminous intensity is $\pm 10\%$.

COLOR BIN LIMIT (RED $I_f = 15$ mA, GREEN $I_f = 10$ mA, BLUE $I_f = 10$ mA)

Red

| Bin Code | Min.(nm) | Max.(nm) |
|----------|----------|----------|
| RB | 619 | 624 |

Green

| Bin Code | Min.(nm) | Max.(nm) |
|----------|----------|----------|
| G7 | 520 | 525 |
| G23 | 522.5 | 527.5 |
| G8 | 525 | 530 |
| G45 | 527.5 | 532.5 |
| G9 | 530 | 535 |
| G67 | 532.5 | 537.5 |
| Ga | 535 | 540 |

Blue

| Bin Code | Min.(nm) | Max.(nm) |
|----------|----------|----------|
| B3 | 460 | 465 |
| B23 | 462.5 | 467.5 |
| B4 | 465 | 470 |
| B45 | 467.5 | 472.5 |
| B5 | 470 | 475 |
| B67 | 472.5 | 477.5 |
| B6 | 475 | 480 |

Tolerance of measurement of dominant wavelength is ± 1 nm.

ORDER CODE TABLE*

| Kit Number | Color | Luminous Intensity (mcd) | | Dominant Wavelength (nm) | | | | Pack- age |
|--------------------------|-------|--|------|--------------------------------------|-----------|-----------|-----------|--------------|
| | | Min. | Max. | Color Bin | Min. (nm) | Color Bin | Max. (nm) | |
| SLV6D-FKB-CKNNQEHHB7a363 | Red | 560 | 1120 | RB | 619 | RB | 624 | Reel |
| | Green | 900 | 1800 | G7 | 520 | Ga | 540 | Reel |
| | Blue | 180 | 450 | B3 | 460 | B6 | 480 | Reel |
| SLV6D-FKB-CK1N1E1BB7D3D3 | Red | Any 1 Intensity bin from K(560) - N(1120) | | RB | 619 | RB | 624 | Reel |
| | Green | Any 1 Intensity bin from N(900) - Q(1800) | | Any 1 hue bin from G7(520) - Ga(540) | | | | Reel |
| | Blue | Any 1 Intensity bin from E(180) - H(450) | | Any 1 hue bin from B3(460) - B6(480) | | | | Reel |
| SLV6D-FKB-CM1P1F1BB7D3D3 | Red | Any 1 Intensity bin from M(710) - N(1120) | | RB | 619 | RB | 624 | Reel |
| | Green | Any 1 Intensity bin from P(1120) - Q(1800) | | Any 1 hue bin from G7(520) - Ga(540) | | | | Reel |
| | Blue | Any 1 Intensity bin from F(224) - H(450) | | Any 1 hue bin from B3(460) - B6(480) | | | | Reel |

Notes:

1. The above kit numbers represent the order codes which include multiple intensity-bin and color-bin codes. Only one intensity-bin code and one color-bin code will be shipped on each reel. Single intensity-bin code and single color-bin code will be orderable in certain quantities.
2. For example, any 1 intensity-bin from K - N means only 1 intensity-bin (K or np or M or qr or N) will be shipped by Cree.
3. For example, any 1 color-bin from G7 - Ga means only 1 color-bin (G7 or G23 or G8 or G45 or G9 or G67 or Ga) will be shipped by Cree.
4. Please refer to the "Cree LED Lamp Reliability Test Standards" document ^{#1} for reliability test conditions.
5. Please refer to the "Cree LED Lamp Soldering & Handling" document ^{#2} for information about how to use this LED product safely.

#1: Refer to http://www.cree.com/led-components/media/documents/LED_Lamp_Reliability_Test_Standard.pdf

#2: Refer to <http://www.cree.com/led-components/media/documents/sh-HB.pdf>

GRAPHS

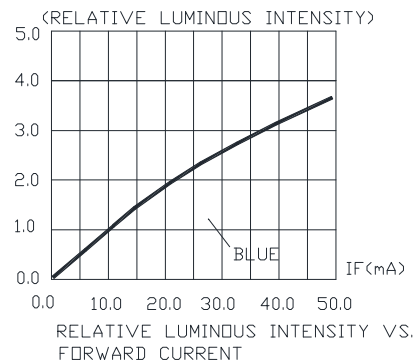
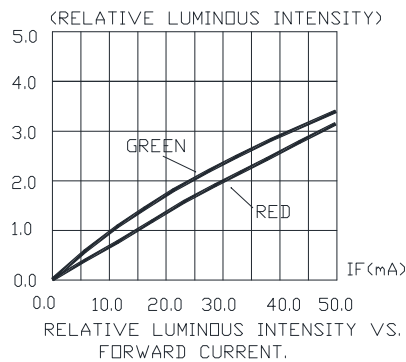
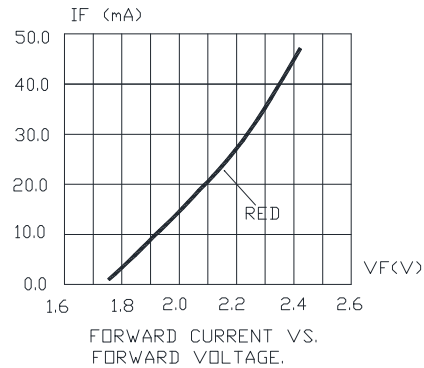
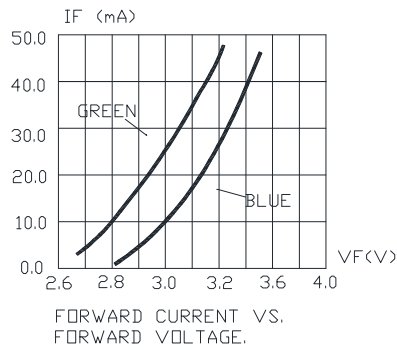
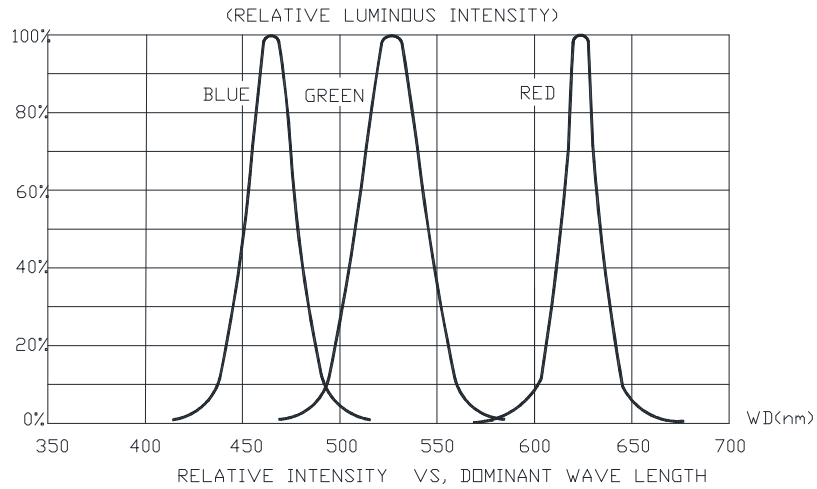

The above data are collected from statistical figures that do not necessarily correspond to the actual parameters of each single LED. Hence, these data will be changed without further notice.

GRAPHS

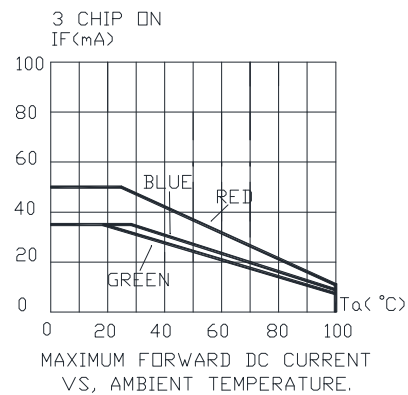
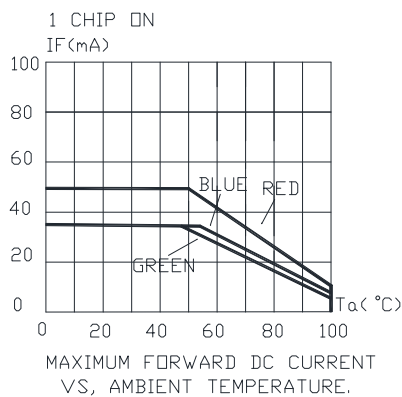
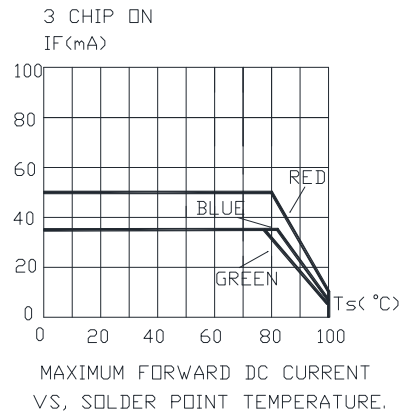
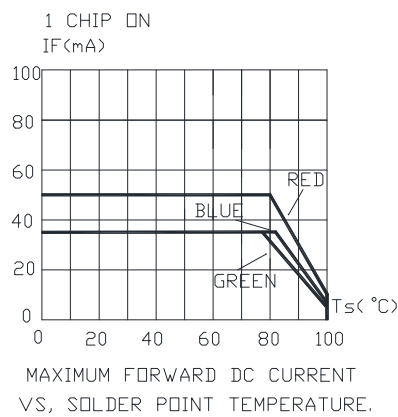
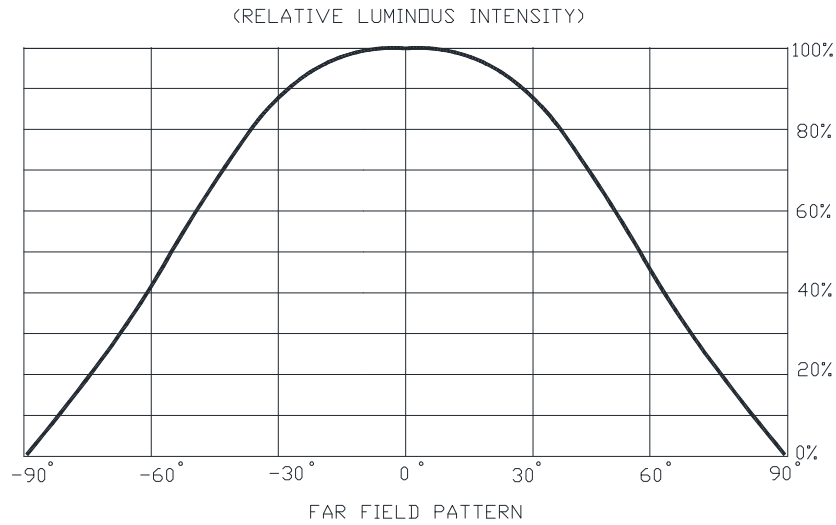

The above data are collected from statistical figures that do not necessarily correspond to the actual parameters of each single LED. Hence, these data will be changed without further notice.

MECHANICAL DIMENSIONS

All dimensions are in mm.

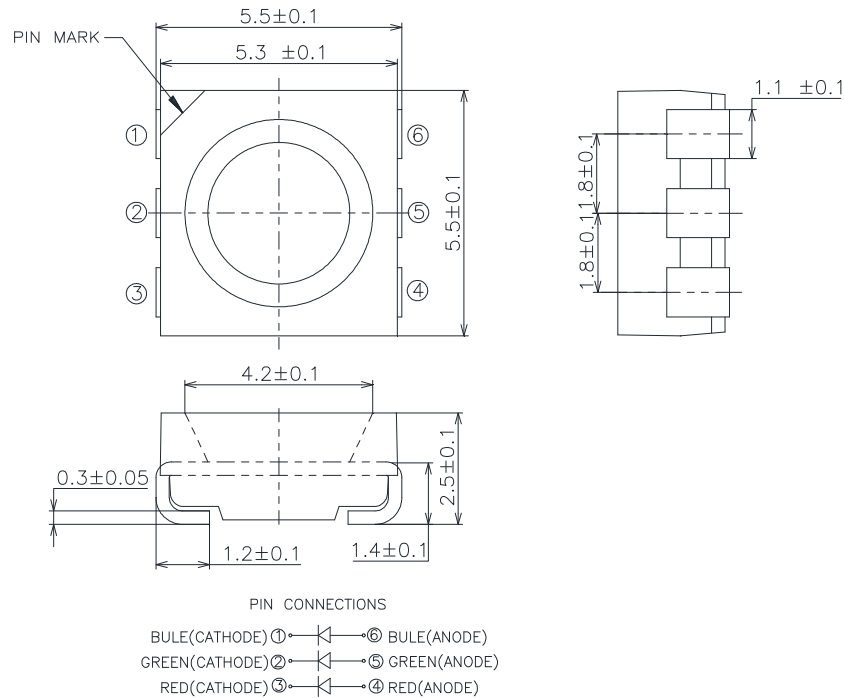

NOTES

RoHS Compliance

The levels of RoHS-restricted materials in this product are below the maximum concentration values (also referred to as the threshold limits) permitted for such substances, or are used in an exempted application in accordance with EU Directive 2011/65/EC (RoHS2), as implemented by EU member states on January 2, 2013 and amended on March 31, 2015 by EU Directive 2015/863/EU.

RoHS Declarations for this product can be obtained from your Cree representative or from the Product Ecology section of the Cree website.

Vision Advisory Claim

Users should be cautioned not to stare at the light of this LED product. The bright light can damage the eye.

KIT NUMBER SYSTEM

Cree LED lamps are tested and sorted into performance bins. A bin is specified by ranges of color, forward voltage, and brightness. Sorted LEDs are packaged for shipping in various convenient options. Please refer to the "Cree LED Lamp Packaging Standard" document for more information about shipping and packaging options.

Cree LEDs are sold by order codes in combinations of bins called kits. Order codes are configured in the following manner:

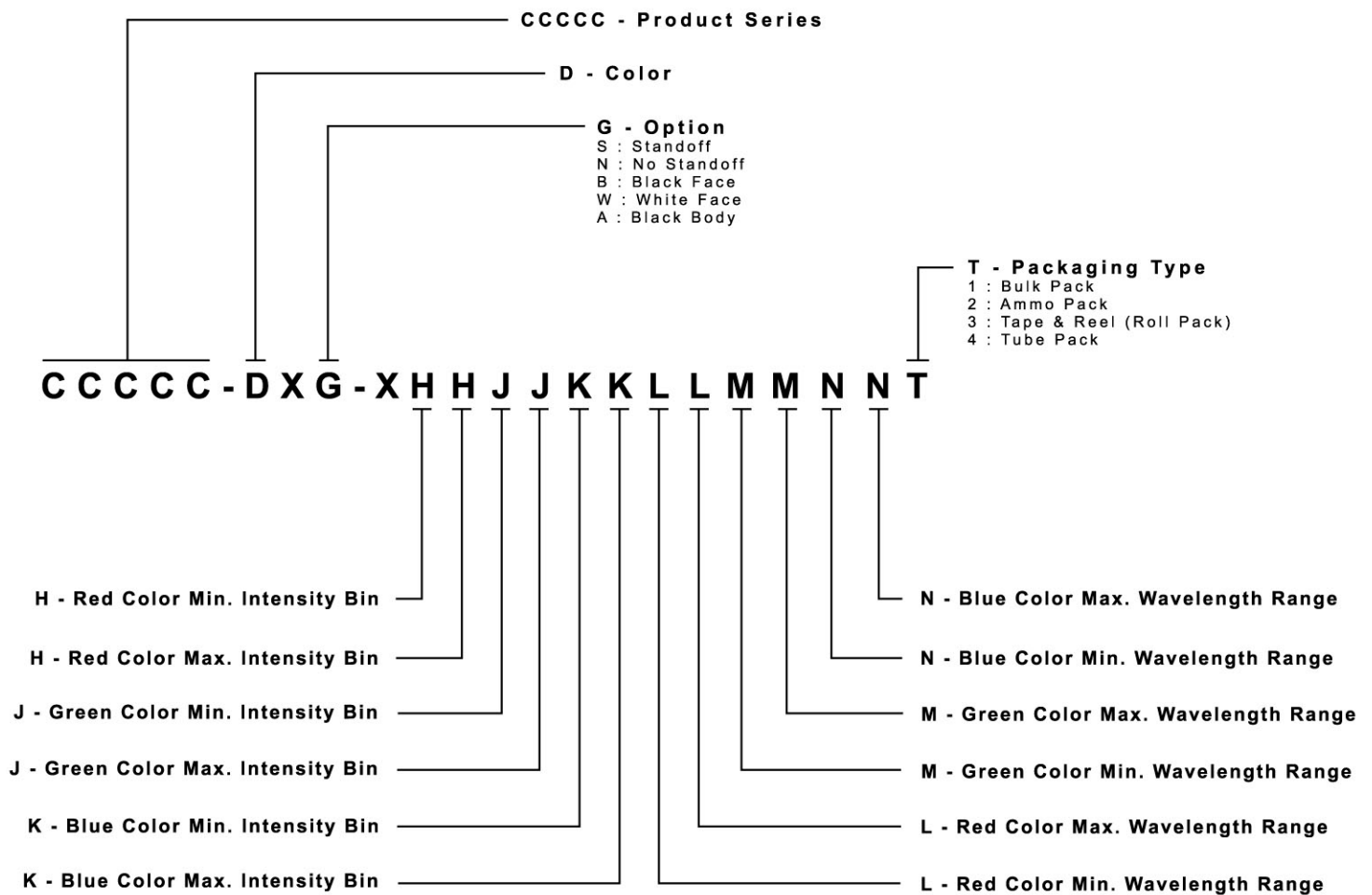

RELIABILITY

Tests and Results

| Test | Applicable Standards | Test Condition | Note | Number of Damaged |
|--|----------------------------|--|------------|-------------------|
| Temperature Cycle | JEITA ED-4701 100 105 | -40°C~25°C~100°C~25°C 30 mins, 5 mins, 30 mins, 5 mins | 100 cycles | 0/45 |
| Thermal Shock | MIL-STD-202G | -40°C~100°C 30 mins, 30 mins | 100 cycles | 0/45 |
| Moisture Resistance | JEITA ED-4701 200 203 | 25°C~65°C~ 90%RH 24hrs/1cycle | 10 cycles | 0/45 |
| High Temperature Storage | JEITA ED-4701 200 201 | T _A =100°C | 500 hrs | 0/45 |
| Temperature Humidity Storage | JEITA ED-4701 100 103 | T _A =60°C RH=90% | 500 hrs | 0/45 |
| Low Temperature Storage | JEITA ED-4701 200 202 | T _A =-40°C | 500 hrs | 0/45 |
| High Temperature Life Test | - | T _A =85°C I _F =15 mA | 1000 hrs | 0/45 |
| Life Test | - | T _A =25°C IF: R=30mA G=35mA B=20mA | 1000 hrs | 0/45 |
| High Humidity Heat Life Test | - | 60°C RH=90% I _F =15 mA | 500 hrs | 0/45 |
| Low Temperature Life Test | - | T _A =-40°C IF: R=30mA G=35mA B=20mA | 500 hrs | 0/45 |
| Resistance to Soldering Heat(Reflow Soldering) | JEITA ED-4701 300 301 | T _{sol} =250°C,10sec (Pre treatment 30°C,70%,168hrs) | 2 times | 0/45 |
| Vibration-variable Frequency | MIL-STE-883 Method 2007 | 20G min, 20 to 2000Hz, 4cycles, 4mins, Each x,y,z | / | 0/45 |
| Electrostatic Discharge Test | AEC(Q101-001) | Human body model 1000 V (Forward and reverse current conduct electricity each 1time) | / | 0/45 |

Failure Criteria

| Item | Symbol | Test Condition | Criteria for Judgment | |
|------------------------------|----------------|------------------------|---------------------------------|--------------------|
| | | | Min. | Max. |
| Forward Voltage | V _F | I _F = 20 mA | - | Initial Data x 1.1 |
| Reverse Current | I _R | V _R = 5 V | - | 10 μA |
| Luminous Flux/Intensity | Φ _V | I _F = 20 mA | Initial Data x 0.7 | - |
| Resistance to Soldering Heat | - | I _F = 20 mA | No dead lamps and visual damage | |
| Vibration-variable Frequency | - | I _F = 20 mA | No dead lamps and visual damage | |

REFLOW SOLDERING

- The SLV6D-FKB is rated as a MSL 5a product.
- The recommended floor life out of bag is 24hrs.
- The temperature profile is as below:

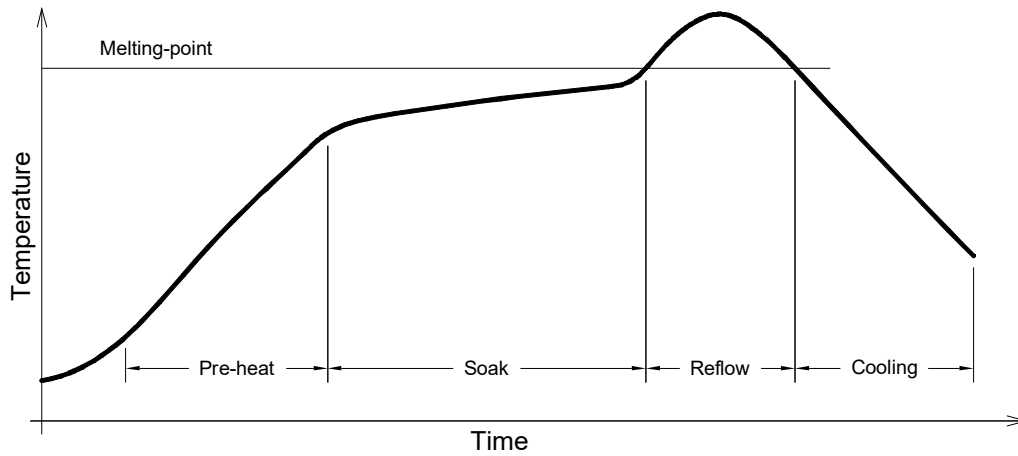

Use only with SLV6D-FKB

| Solder |
|--|
| Average ramp-up rate = 4°C/s max |
| Preheat temperature = 150°C ~200°C |
| Preheat time = 120s max |
| Ramp-down rate = 6°C/s max |
| Peak temperature = 250°C max |
| Time within 5°C of actual Peak Temperature = 10s max |
| Duration above 217°C is 60s max |

Soldering pad:

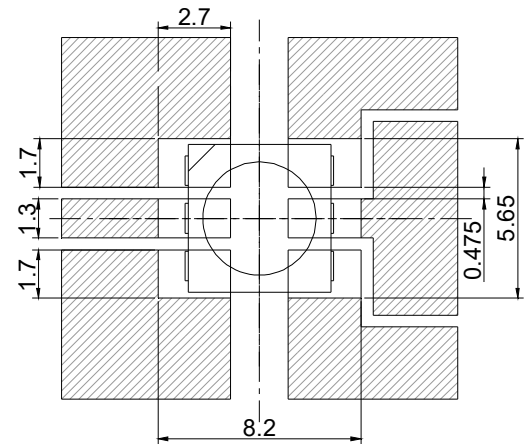

Refer to "<http://www.cree.com/led-components/media/documents/sh-HB.pdf>" for soldering & handling details.

NOTES

- The packaging sizes of these SMD products are very small and the resin is still soft after solidification. Users are required to handle with care. Never touch the resin surface of SMD products.
- To avoid damaging the product's surface and interior device, it is recommended to choose a special nozzle to pick up the SMD products during the process of SMT production. If handling is necessary, take special care when picking up these products. The following method is necessary:

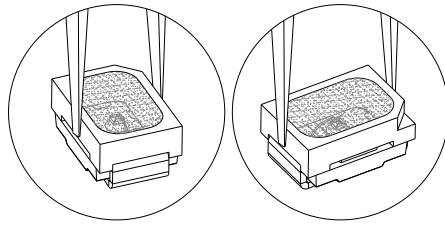

PACKAGING

- The boxes are not water resistant and they must be kept away from water and moisture.
- The LEDs are packed in cardboard boxes after packaging in normal or anti-electrostatic bags.
- Cardboard boxes will be used to protect the LEDs from mechanical shocks during transportation.
- The reel pack is applied in SMD LED.
- Max 3000 pcs per reel.

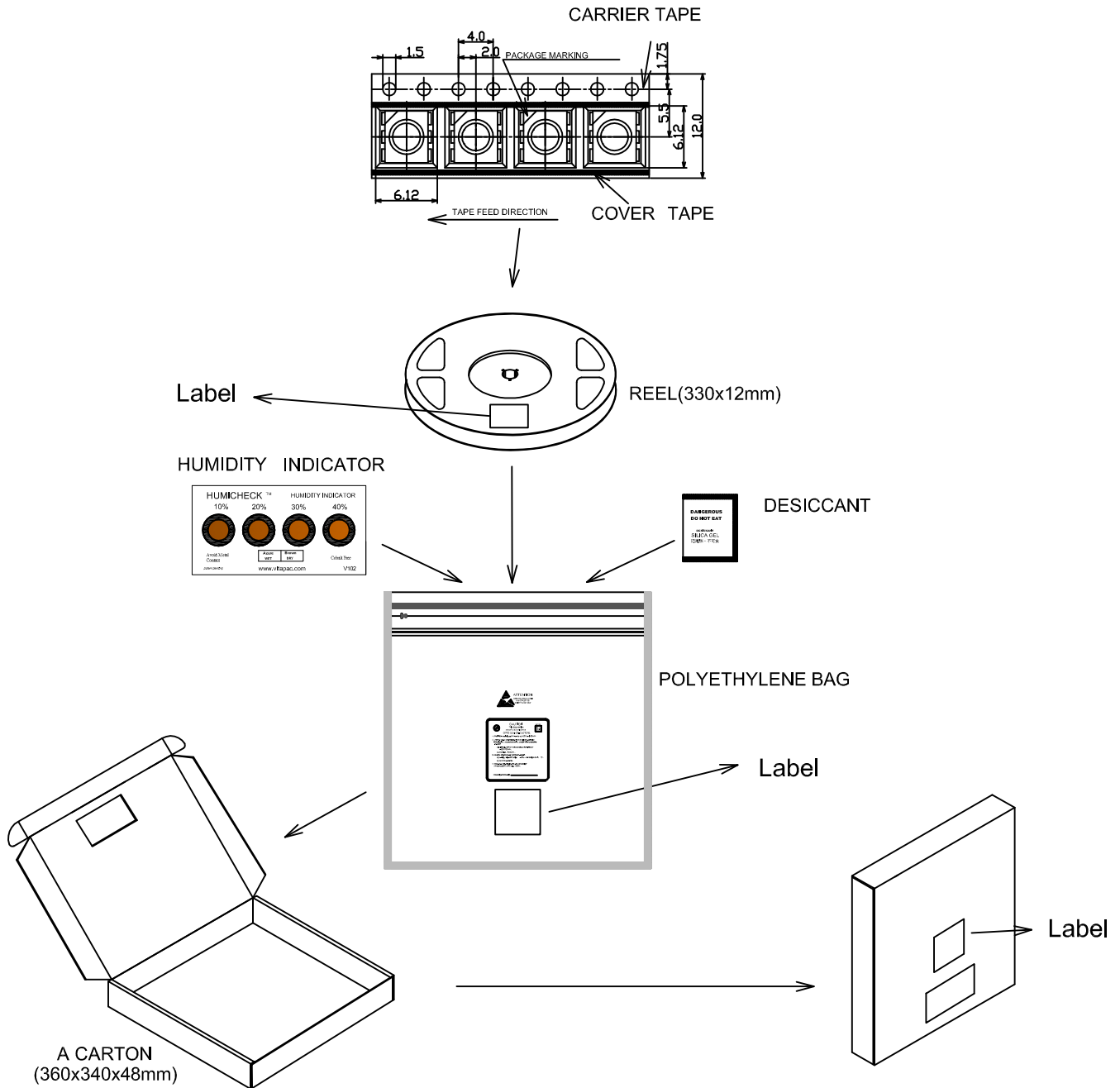

Компания «Океан Электроники» предлагает заключение долгосрочных отношений при поставках импортных электронных компонентов на взаимовыгодных условиях!

Наши преимущества:

- Поставка оригинальных импортных электронных компонентов напрямую с производств Америки, Европы и Азии, а так же с крупнейших складов мира;
- Широкая линейка поставок активных и пассивных импортных электронных компонентов (более 30 млн. наименований);
- Поставка сложных, дефицитных, либо снятых с производства позиций;
- Оперативные сроки поставки под заказ (от 5 рабочих дней);
- Экспресс доставка в любую точку России;
- Помощь Конструкторского Отдела и консультации квалифицированных инженеров;
- Техническая поддержка проекта, помощь в подборе аналогов, поставка прототипов;
- Поставка электронных компонентов под контролем ВП;
- Система менеджмента качества сертифицирована по Международному стандарту ISO 9001;
- При необходимости вся продукция военного и аэрокосмического назначения проходит испытания и сертификацию в лаборатории (по согласованию с заказчиком);
- Поставка специализированных компонентов военного и аэрокосмического уровня качества (Xilinx, Altera, Analog Devices, Intersil, Interpoint, Microsemi, Actel, Aeroflex, Peregrine, VPT, Syfer, Eurofarad, Texas Instruments, MS Kennedy, Miteq, Cobham, E2V, MA-COM, Hittite, Mini-Circuits, General Dynamics и др.);

Компания «Океан Электроники» является официальным дистрибьютором и эксклюзивным представителем в России одного из крупнейших производителей разъемов военного и аэрокосмического назначения «JONHON», а так же официальным дистрибьютором и эксклюзивным представителем в России производителя высокотехнологичных и надежных решений для передачи СВЧ сигналов «FORSTAR».



JONHON

«JONHON» (основан в 1970 г.)

Разъемы специального, военного и аэрокосмического назначения:

(Применяются в военной, авиационной, аэрокосмической, морской, железнодорожной, горно- и нефтедобывающей отраслях промышленности)

«FORSTAR» (основан в 1998 г.)

ВЧ соединители, коаксиальные кабели,
кабельные сборки и микроволновые компоненты:

(Применяются в телекоммуникациях гражданского и специального назначения, в средствах связи, РЛС, а так же военной, авиационной и аэрокосмической отраслях промышленности).



Телефон: 8 (812) 309-75-97 (многоканальный)

Факс: 8 (812) 320-03-32

Электронная почта: ocean@oceanchips.ru

Web: <http://oceanchips.ru/>

Адрес: 198099, г. Санкт-Петербург, ул. Калинина, д. 2, корп. 4, лит. А