

FEATURES

- High performance, single-/dual-axis accelerometer on a single IC chip
- 5 mm × 5 mm × 2 mm LCC package
- 1 mg resolution at 60 Hz
- Low power: 700 μA at $V_S = 5\text{ V}$ (typical)
- High zero g bias stability
- High sensitivity accuracy
- -40°C to $+125^\circ\text{C}$ temperature range
- X and Y axes aligned to within 0.1° (typical)
- Bandwidth adjustment with a single capacitor
- Single-supply operation
- 3500 g shock survival
- RoHS compliant
- Compatible with Sn/Pb- and Pb-free solder processes

APPLICATIONS

- Platform stabilization/leveling
- Navigation
- Alarms and motion detectors
- High accuracy, 2-axis tilt sensing
- Vibration monitoring and compensation
- Abuse event detection

GENERAL DESCRIPTION

The [ADXL103/ADXL203](#) are high precision, low power, complete single- and dual-axis accelerometers with signal conditioned voltage outputs, all on a single, monolithic IC. The [ADXL103/ADXL203](#) measure acceleration with a full-scale range of $\pm 1.7\text{ g}$, $\pm 5\text{ g}$, or $\pm 18\text{ g}$. The [ADXL103/ADXL203](#) can measure both dynamic acceleration (for example, vibration) and static acceleration (for example, gravity).

The typical noise floor is $110\ \mu\text{g}/\sqrt{\text{Hz}}$, allowing signals below 1 mg (0.06° of inclination) to be resolved in tilt sensing applications using narrow bandwidths ($< 60\text{ Hz}$).

The user selects the bandwidth of the accelerometer using Capacitor C_X and Capacitor C_Y at the X_{OUT} and Y_{OUT} pins. Bandwidths of 0.5 Hz to 2.5 kHz can be selected to suit the application.

The [ADXL103](#) and [ADXL203](#) are available in a 5 mm × 5 mm × 2 mm, 8-terminal ceramic LCC package.

FUNCTIONAL BLOCK DIAGRAMS

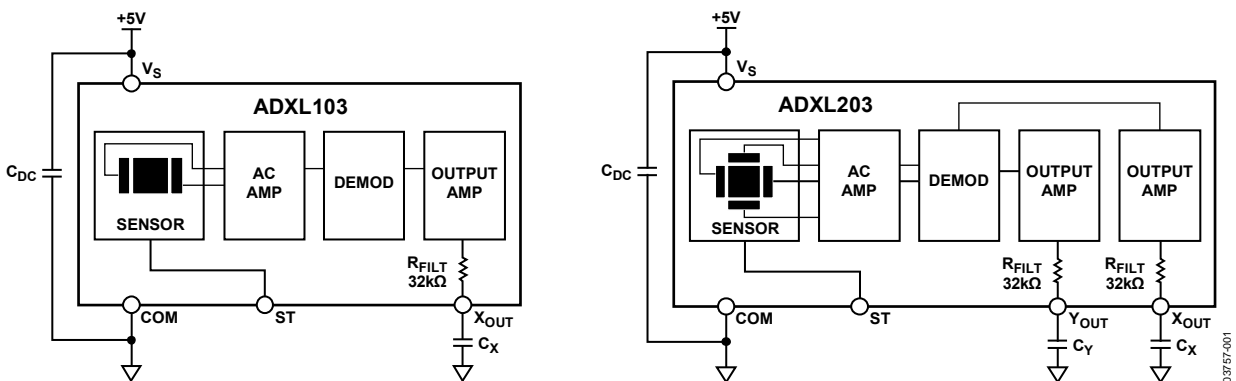

Figure 1.

Rev. F

[Document Feedback](#)

Information furnished by Analog Devices is believed to be accurate and reliable. However, no responsibility is assumed by Analog Devices for its use, nor for any infringements of patents or other rights of third parties that may result from its use. Specifications subject to change without notice. No license is granted by implication or otherwise under any patent or patent rights of Analog Devices. Trademarks and registered trademarks are the property of their respective owners.

One Technology Way, P.O. Box 9106, Norwood, MA 02062-9106, U.S.A.
 Tel: 781.329.4700 ©2004–2018 Analog Devices, Inc. All rights reserved.
[Technical Support](#) www.analog.com

TABLE OF CONTENTS

Features	1	Theory of Operation	13
Applications.....	1	Performance.....	13
General Description	1	Applications Information	14
Functional Block Diagrams.....	1	Power Supply Decoupling.....	14
Revision History	2	Setting the Bandwidth Using C_X and C_Y	14
Specifications.....	3	Self Test	14
Absolute Maximum Ratings.....	4	Design Trade-Offs for Selecting Filter Characteristics: The Noise/Bandwidth Trade-Off.....	14
ESD Caution.....	4	Using the ADXL103/ADXL203 with Operating Voltages Other than 5 V.....	15
Pin Configurations and Function Descriptions	5	Using the ADXL203 as a Dual-Axis Tilt Sensor	15
Typical Performance Characteristics	6	Outline Dimensions	16
ADXL103 and ADXL203	6	Ordering Guide	16
AD22293.....	9		
AD22035 and AD22037	10		
All Models	12		

REVISION HISTORY

5/2018—Rev. E to Rev. F

Changes to Features Section and Applications Section.....	1
Changes to Noise Parameter, Table 1.....	3
Changes to Ordering Guide.....	16
Deleted Automotive Products Section.....	16

1/2014—Rev. D to Rev. E

Changes to Ordering Guide	16
---------------------------------	----

9/2011—Rev. C to Rev. D

Added AD22293, AD22035, and AD22037	Throughout
Changes to Application Section and General Description Section.....	1
Changes to Table 1.....	3
Deleted Figure 13 and Figure 14: Renumbered Sequentially	7
Deleted Figure 17 and Figure 22.....	8
Added Figure 19 to Figure 24; Renumbered Sequentially	9
Added Figure 25 to Figure 34.....	10
Added All Models Section, Figure 35 to Figure 38	12
Changes to Figure 39.....	13
Changes to Ordering Guide	16
Changes to Automotive Products Section.....	16

5/2010—Rev. B to Rev. C

Changes to Figure 24 Caption.....	12
Added Automotive Products Section.....	12

4/2010—Rev. A to Rev. B

Changes to Features Section	1
Updated Outline Dimensions.....	12
Changes to Ordering Guide.....	12

2/2006—Rev. 0 to Rev. A

Changes to Features	1
Changes to Table 1.....	3
Changes to Figure 2.....	4
Changes to Figure 3 and Figure 4.....	5
Changes to the Performance Section	9

4/2004—Revision 0: Initial Version

SPECIFICATIONS

$T_A = -40^{\circ}\text{C}$ to $+125^{\circ}\text{C}$, $V_S = 5\text{ V}$, $C_X = C_Y = 0.1\ \mu\text{F}$, acceleration = 0 g , unless otherwise noted. All minimum and maximum specifications are guaranteed. All typical specifications are not guaranteed.

Table 1.

Parameter	Test Conditions	ADXL103/ADXL203			AD22293			AD22035/AD22037			Unit
		Min	Typ	Max	Min	Typ	Max	Min	Typ	Max	
SENSOR	Each axis										
Measurement Range ¹		±1.7			±5	±6		±18			g
Nonlinearity	% of full scale		±0.2	±1.25		±0.2	±1.25		±0.2	±1.25	%
Package Alignment Error			±1			±1			±1		Degrees
Alignment Error (ADXL203)	X to Y sensor		±0.1			±0.1			±0.1		Degrees
Cross-Axis Sensitivity			±1.5	±3		±1.5	±3		±1.5	±3	%
SENSITIVITY (RATIOMETRIC) ²	Each axis										
Sensitivity at $X_{\text{OUT}}, Y_{\text{OUT}}$	$V_S = 5\text{ V}$	960	1000	1040	293	312	331	94	100	106	mV/g
Sensitivity Change Due to Temperature ³	$V_S = 5\text{ V}$		±0.3			±0.3			±0.3		%
ZERO g BIAS LEVEL (RATIOMETRIC)	Each axis										
0 g Voltage at $X_{\text{OUT}}, Y_{\text{OUT}}$	$V_S = 5\text{ V}$	2.4	2.5	2.6	2.4	2.5	2.6	2.4	2.5	2.6	V
Initial 0 g Output Deviation from Ideal	$V_S = 5\text{ V}, 25^{\circ}\text{C}$		±25			±50			±125		mg
0 g Offset vs. Temperature			±0.1	±0.8		±0.3	±1.8		±1		mg/°C
NOISE											
Output Noise			1	3		0.4			0.2		mV rms
Noise Density			110			130			230		$\mu\text{g}/\sqrt{\text{Hz}}$ rms
FREQUENCY RESPONSE ⁴											
C_X, C_Y Range ⁵		0.002		10	0.002		10	0.002		10	μF
R_{FILT} Tolerance		24	32	40	24	32	40	24	32	40	k Ω
Sensor Resonant Frequency			5.5			5.5			5.5		kHz
SELF TEST ⁶											
Logic Input Low				1			1			1	V
Logic Input High		4			4			4			V
ST Input Resistance to GND		30	50		30	50		30	50		k Ω
Output Change at $X_{\text{OUT}}, Y_{\text{OUT}}$	ST 0 to ST 1	450	750	1100	125	250	375	60	80	100	mV
OUTPUT AMPLIFIER											
Output Swing Low	No load	0.05	0.2		0.05	0.2		0.05	0.2		V
Output Swing High	No load		4.5	4.8		4.5	4.8		4.5	4.8	V
POWER SUPPLY (V_{DD})											
Operating Voltage Range		3		6	3		6	3		6	V
Quiescent Supply Current			0.7	1.1		0.7	1.1		0.7	1.1	mA
Turn-On Time ⁷			20			20			20		ms

¹ Guaranteed by measurement of initial offset and sensitivity.

² Sensitivity is essentially ratiometric to V_S . For $V_S = 4.75\text{ V}$ to 5.25 V , sensitivity is 186 mV/V/g to 215 mV/V/g .

³ Defined as the output change from ambient-to-maximum temperature or ambient-to-minimum temperature.

⁴ Actual frequency response controlled by user-supplied external capacitor (C_X, C_Y).

⁵ Bandwidth = $1/(2 \times \pi \times 32\text{ k}\Omega \times C)$. For $C_X, C_Y = 0.002\ \mu\text{F}$, bandwidth = 2500 Hz . For $C_X, C_Y = 10\ \mu\text{F}$, bandwidth = 0.5 Hz . Minimum/maximum values are not tested.

⁶ Self-test response changes cubically with V_S .

⁷ Larger values of C_X, C_Y increase turn-on time. Turn-on time is approximately $160 \times C_X$ or $C_Y + 4\text{ ms}$, where C_X, C_Y are in μF .

ABSOLUTE MAXIMUM RATINGS

Table 2.

Parameter	Rating
Acceleration (Any Axis, Unpowered)	3500 g
Acceleration (Any Axis, Powered)	3500 g
Drop Test (Concrete Surface)	1.2 m
V _s	-0.3 V to +7.0 V
All Other Pins	(COM - 0.3 V) to (V _s + 0.3 V)
Output Short-Circuit Duration (Any Pin to Common)	Indefinite
Temperature Range (Powered)	-55°C to +125°C
Temperature Range (Storage)	-65°C to +150°C

Table 3. Package Characteristics

Package Type	θ _{JA}	θ _{JC}	Device Weight
8-Terminal Ceramic LCC	120°C/W	20°C/W	<1.0 gram

ESD CAUTION



ESD (electrostatic discharge) sensitive device. Charged devices and circuit boards can discharge without detection. Although this product features patented or proprietary protection circuitry, damage may occur on devices subjected to high energy ESD. Therefore, proper ESD precautions should be taken to avoid performance degradation or loss of functionality.

Stresses at or above those listed under Absolute Maximum Ratings may cause permanent damage to the product. This is a stress rating only; functional operation of the product at these or any other conditions above those indicated in the operational section of this specification is not implied. Operation beyond the maximum operating conditions for extended periods may affect product reliability.

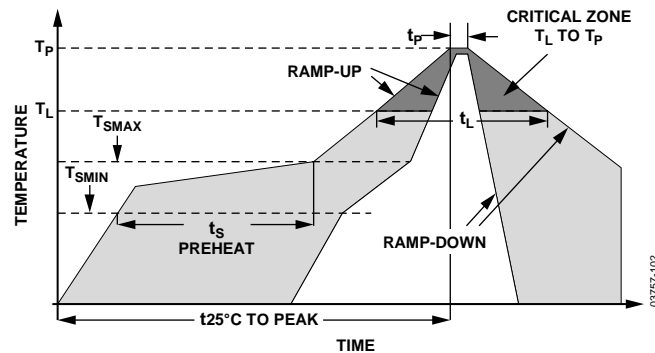
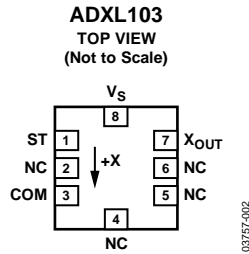

Figure 2. Recommended Soldering Profile

Table 4. Solder Profile Parameters

Profile Feature	Test Condition	
	Sn63/Pb37	Pb-Free
Average Ramp Rate (T _L to T _P)	3°C/second maximum	3°C/second maximum
Preheat		
Minimum Temperature (T _{S MIN})	100°C	150°C
Maximum Temperature (T _{S MAX})	150°C	200°C
Time (T _{S MIN} to T _{S MAX}) (t _S)	60 seconds to 120 seconds	60 seconds to 150 seconds
T _{S MAX} to T _L		
Ramp-Up Rate	3°C/second	3°C/second
Time Maintained Above Liquidous (T _L)		
Liquidous Temperature (T _L)	183°C	217°C
Time (t _L)	60 seconds to 150 seconds	60 seconds to 150 seconds
Peak Temperature (T _P)	240°C + 0°C/-5°C	260°C + 0°C/-5°C
Time Within 5°C of Actual Peak Temperature (t _P)	10 seconds to 30 seconds	20 seconds to 40 seconds
Ramp-Down Rate	6°C/second maximum	6°C/second maximum
Time 25°C to Peak Temperature	6 minutes maximum	8 minutes maximum

PIN CONFIGURATIONS AND FUNCTION DESCRIPTIONS



NOTES
1. NC = NO CONNECT. DO NOT CONNECT TO THIS PIN.

Figure 3. [ADXL103 Pin Configuration](#)

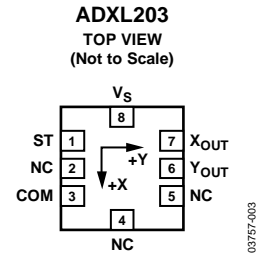

NOTES
1. NC = NO CONNECT. DO NOT CONNECT TO THIS PIN.

Figure 4. [ADXL203 Pin Configuration](#)

Table 5. [ADXL103 Pin Function Descriptions](#)

Pin No.	Mnemonic	Description
1	ST	Self Test
2	NC	Do Not Connect
3	COM	Common
4	NC	Do Not Connect
5	NC	Do Not Connect
6	NC	Do Not Connect
7	X _{OUT}	X Channel Output
8	V _S	3 V to 6 V

Table 6. [ADXL203 Pin Function Descriptions](#)

Pin No.	Mnemonic	Description
1	ST	Self Test
2	NC	Do Not Connect
3	COM	Common
4	NC	Do Not Connect
5	NC	Do Not Connect
6	Y _{OUT}	Y Channel Output
7	X _{OUT}	X Channel Output
8	V _S	3 V to 6 V

TYPICAL PERFORMANCE CHARACTERISTICS

ADXL103 AND ADXL203

V_s = 5 V for all graphs, unless otherwise noted.

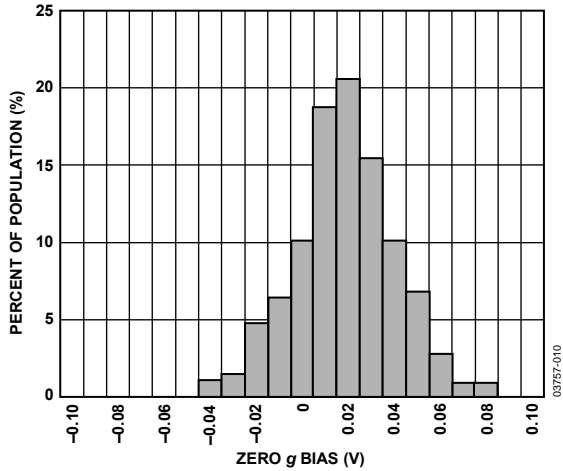

Figure 5. X-Axis Zero g Bias Deviation from Ideal at 25°C

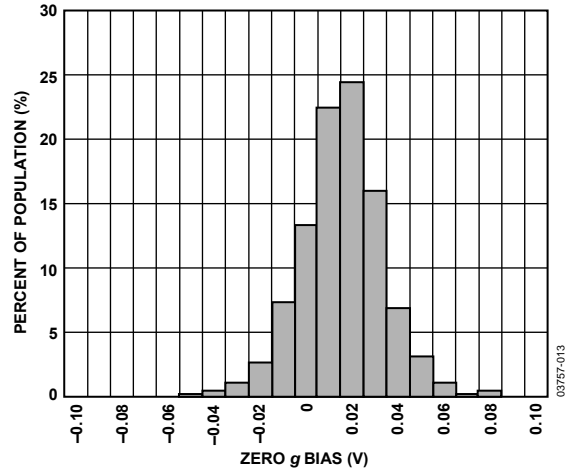

Figure 8. Y-Axis Zero g Bias Deviation from Ideal at 25°C

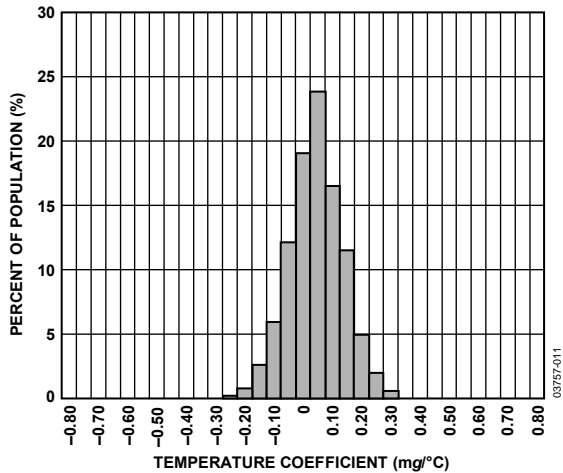

Figure 6. X-Axis Zero g Bias Temperature Coefficient

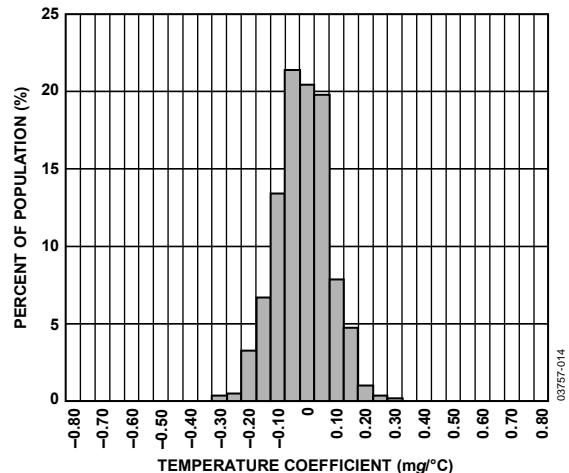

Figure 9. Y-Axis Zero g Bias Temperature Coefficient

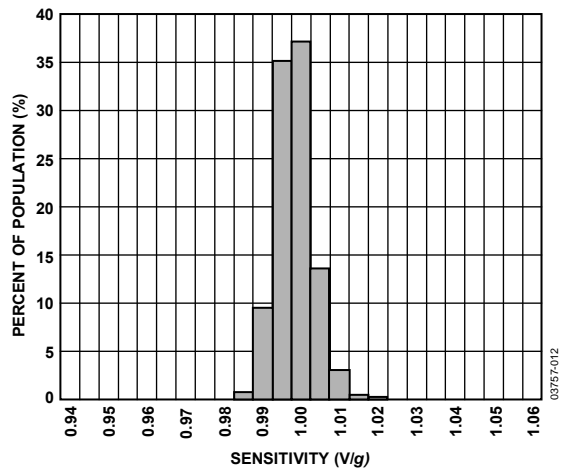

Figure 7. X-Axis Sensitivity at 25°C

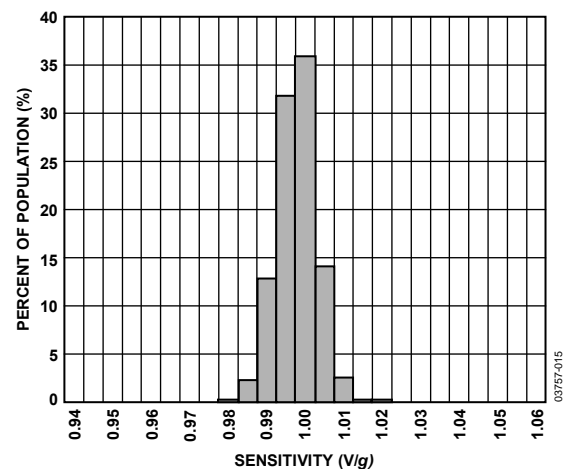

Figure 10. Y-Axis Sensitivity at 25°C

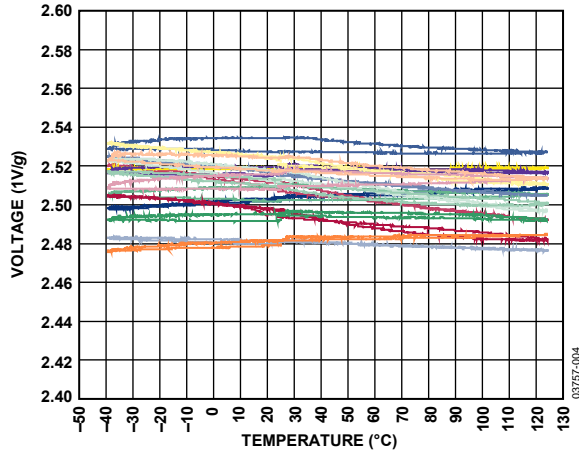

Figure 11. Zero g Bias vs. Temperature; Devices Soldered to PCB

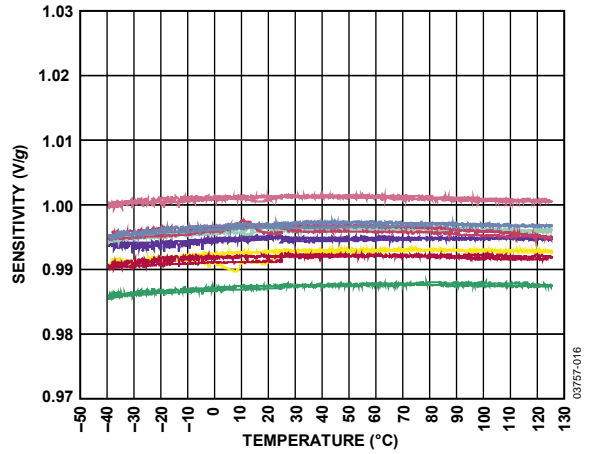

Figure 13. Sensitivity vs. Temperature; Devices Soldered to PCB

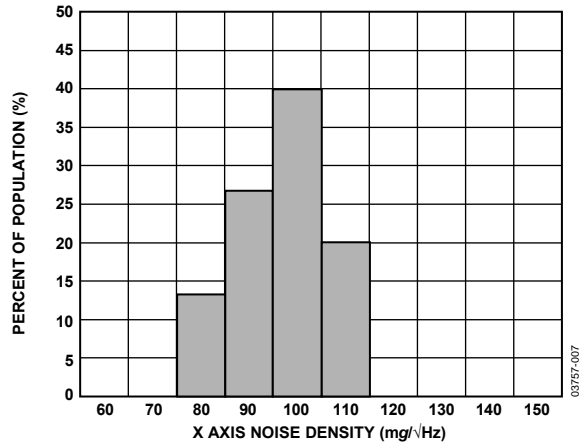

Figure 12. X-Axis Noise Density at 25°C

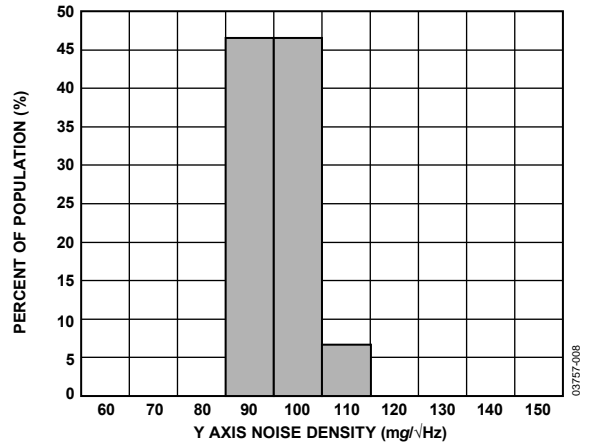

Figure 14. Y-Axis Noise Density at 25°C

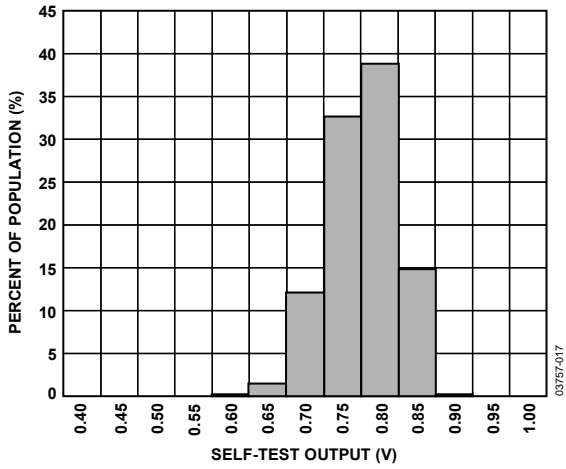

Figure 15. X-Axis Self-Test Response at 25°C

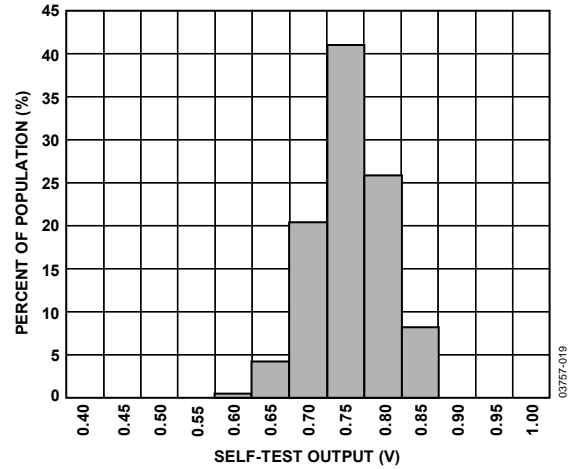

Figure 17. Y-Axis Self-Test Response at 25°C

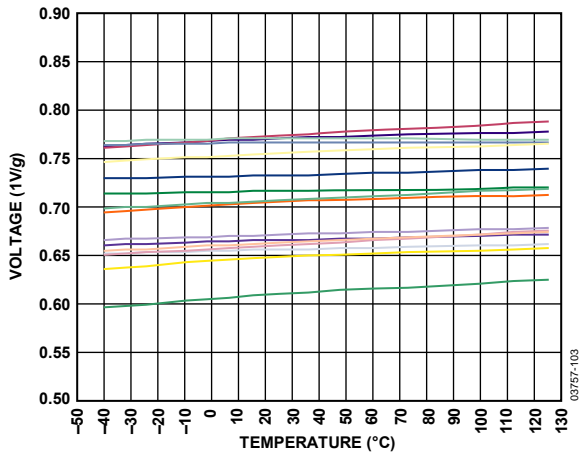

Figure 16. Self-Test Response vs. Temperature

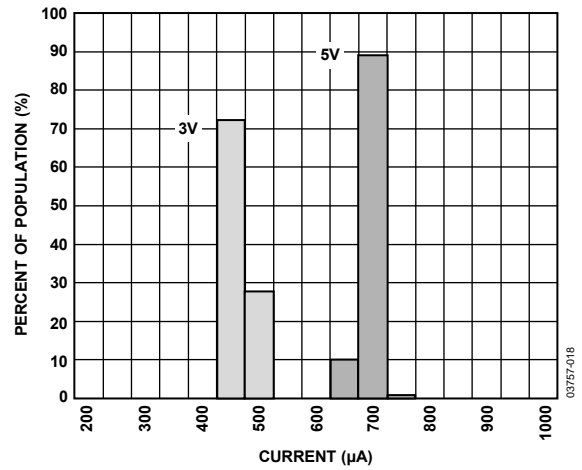

Figure 18. Supply Current at 25°C

AD22293

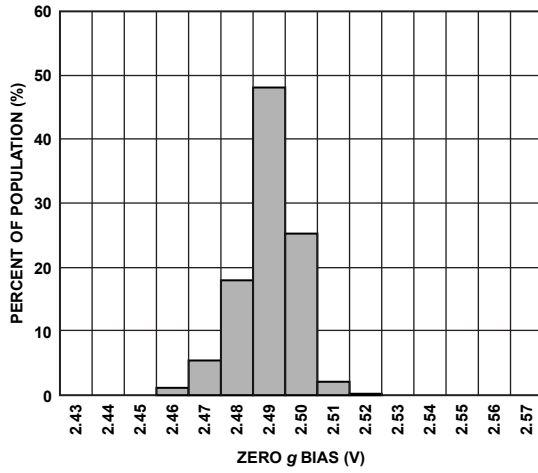

Figure 19. X-Axis Zero g Bias at 25°C

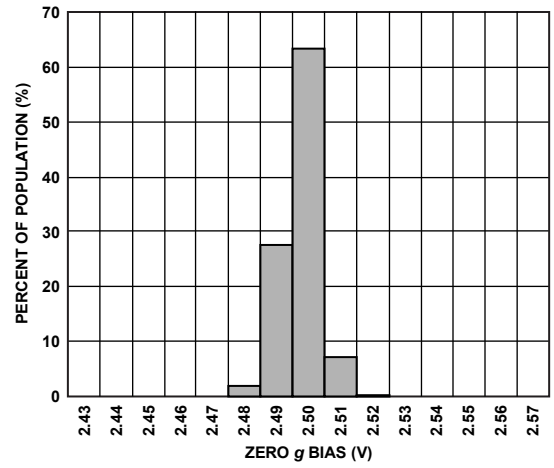

Figure 22. Y-Axis Zero g Bias at 25°C

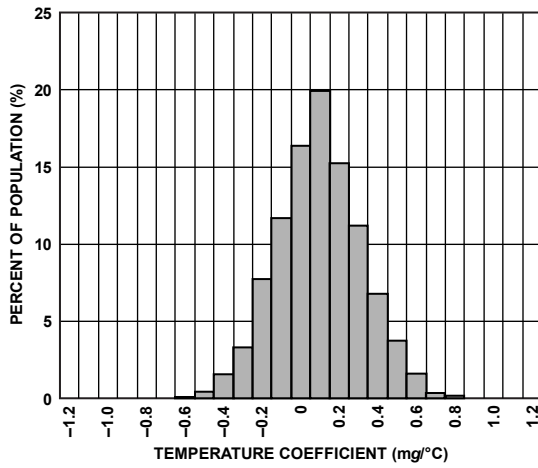

Figure 20. X-Axis Zero g Bias Temperature Coefficient

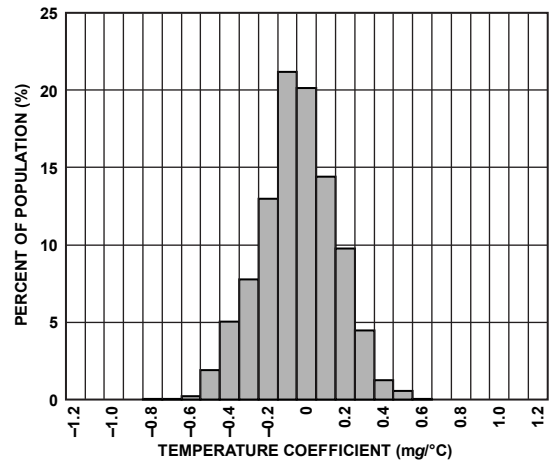

Figure 23. Y-Axis Zero g Bias Temperature Coefficient

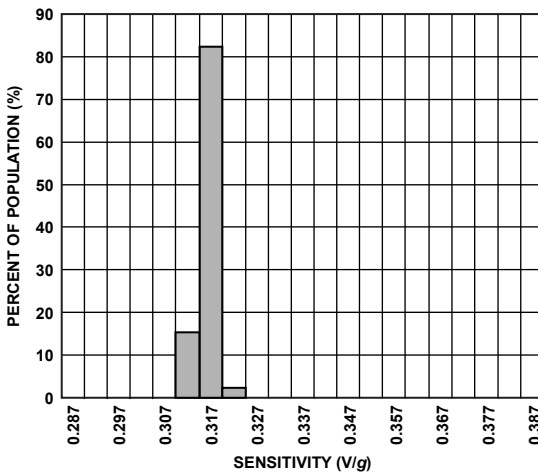

Figure 21. X-Axis Sensitivity at 25°C

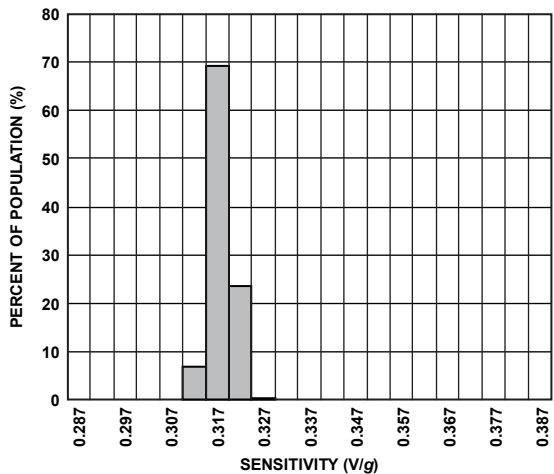

Figure 24. Y-Axis Sensitivity at 25°C

AD22035 AND AD22037

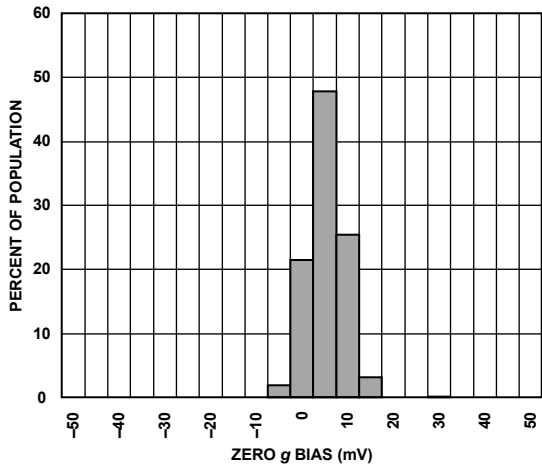

Figure 25. X-Axis Zero g Bias Deviation from Ideal at 25°C

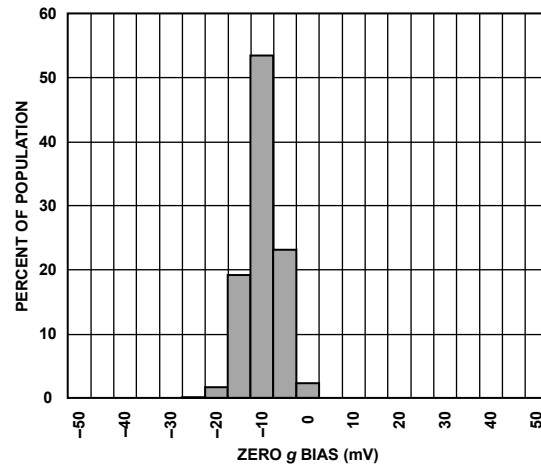

Figure 28. Y-Axis Zero g Bias Deviation from Ideal at 25°C

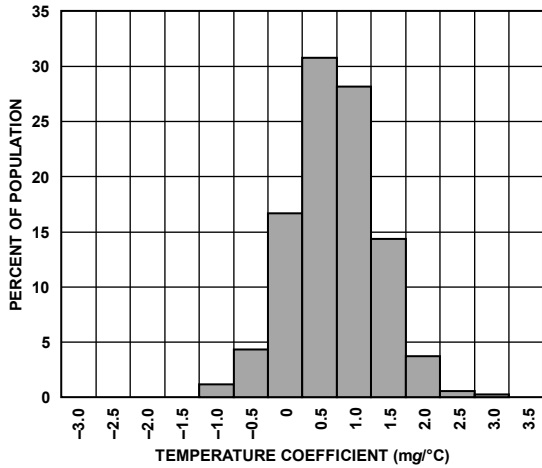

Figure 26. X-Axis Zero g Bias Temperature Coefficient

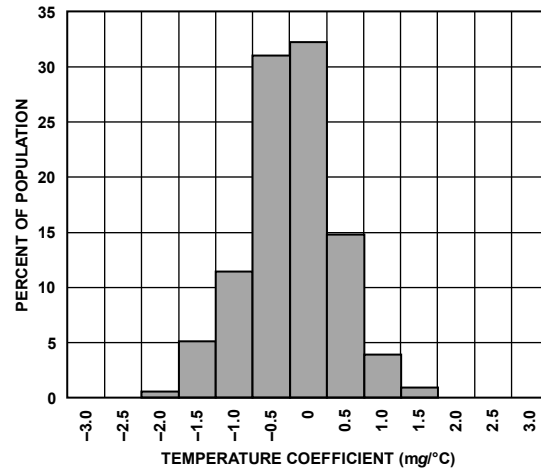

Figure 29. Y-Axis Zero g Bias Temperature Coefficient

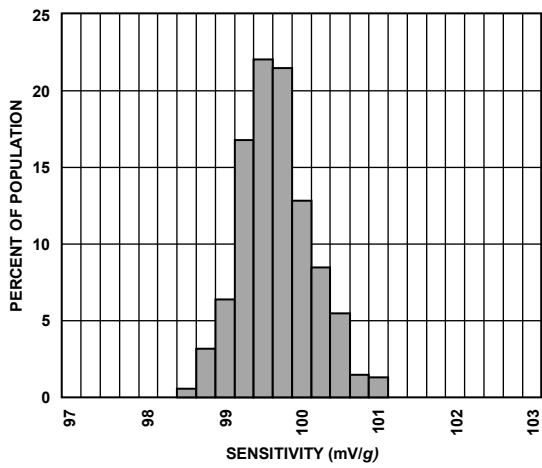

Figure 27. X-Axis Sensitivity at 25°C

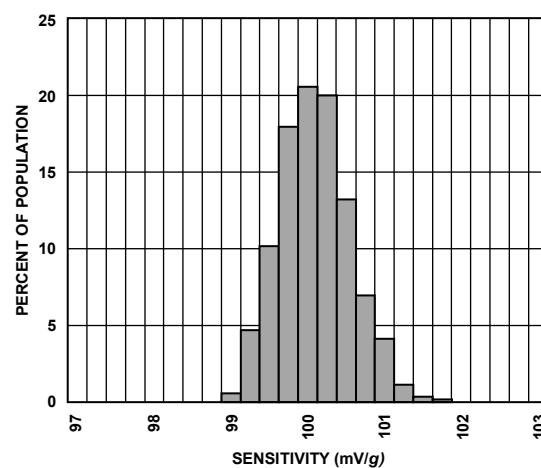

Figure 30. Y-Axis Sensitivity at 25°C

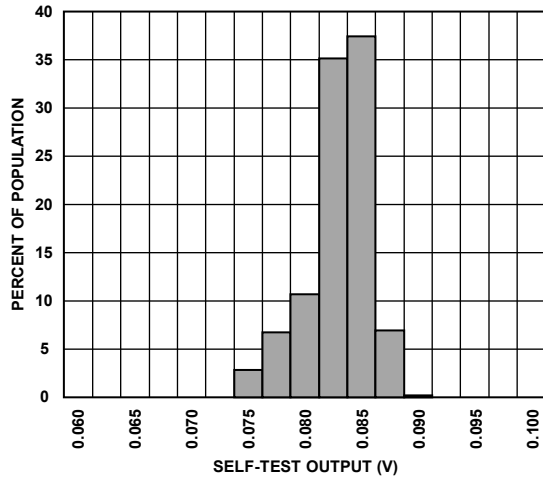

Figure 31. X-Axis Self Test Response at 25°C

03757-111

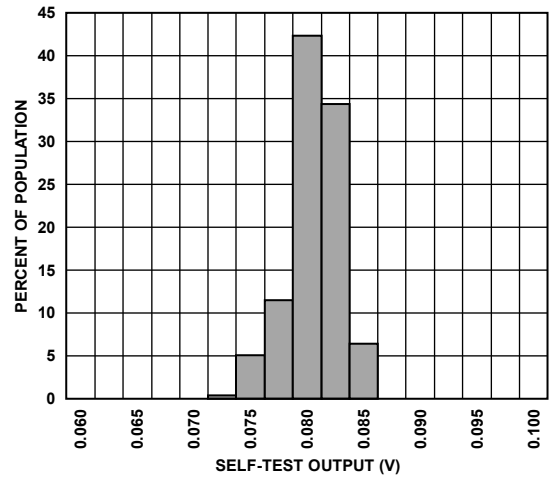

Figure 33. Y-Axis Self Test Response at 25°C

03757-114

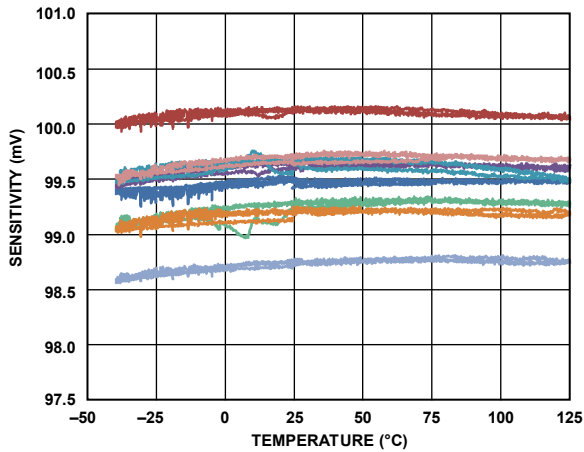

Figure 32. Sensitivity vs. Temperature; Devices Soldered to PCB

03757-112

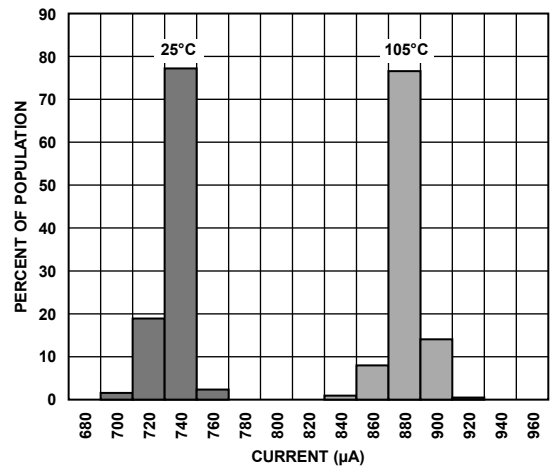

Figure 34. Supply Current vs. Temperature

03757-113

ALL MODELS

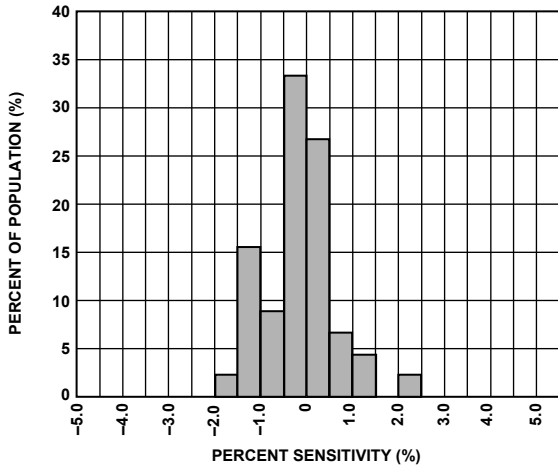

Figure 35. Z vs. X Cross-Axis Sensitivity

09781-023

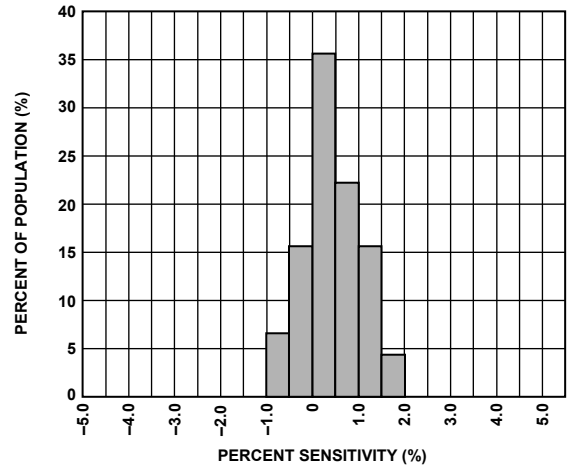

Figure 37. Z vs. Y Cross-Axis Sensitivity

09781-026

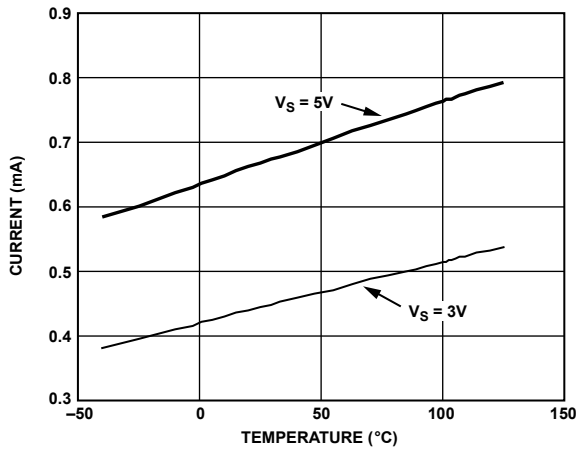

Figure 36. Supply Current vs. Temperature

09781-024

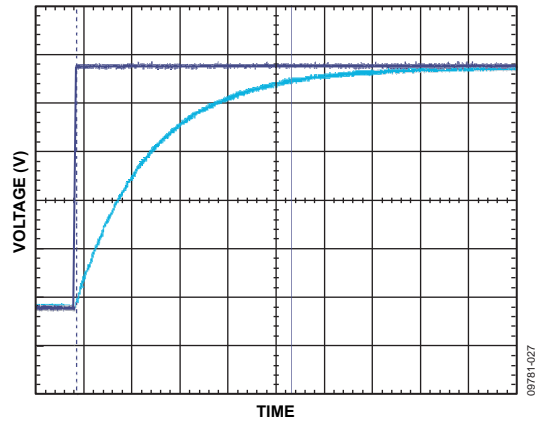

Figure 38. Turn-On Time; $C_x, C_y = 0.1 \mu F$, Time Scale = 2 ms/DIV

09781-027

THEORY OF OPERATION

The ADXL103/ADXL203 are complete acceleration measurement systems on a single, monolithic IC. The ADXL103 is a single-axis accelerometer, and the ADXL203 is a dual-axis accelerometer. Both devices contain a polysilicon surface micromachined sensor and signal conditioning circuitry to implement an open-loop acceleration measurement architecture. The output signals are analog voltages that are proportional to acceleration. The ADXL103/ADXL203 are capable of measuring both positive and negative accelerations from $\pm 1.7\text{ g}$ to at least $\pm 18\text{ g}$. The accelerometer can measure static acceleration forces, such as gravity, allowing it to be used as a tilt sensor.

The sensor is a surface micromachined polysilicon structure built on top of the silicon wafer. Polysilicon springs suspend the structure over the surface of the wafer and provide a resistance against acceleration forces. Deflection of the structure is measured using a differential capacitor that consists of independent fixed plates and plates attached to the moving mass. The fixed plates are driven by 180° out-of-phase square waves. Acceleration deflects the beam and unbalances the differential capacitor, resulting in an output square wave whose amplitude is proportional to acceleration. Phase-sensitive demodulation techniques then rectify the signal and determine the direction of the acceleration.

The output of the demodulator is amplified and brought off-chip through a $32\text{ k}\Omega$ resistor. At this point, the user can set the signal bandwidth of the device by adding a capacitor. This filtering improves measurement resolution and helps prevent aliasing.

PERFORMANCE

Rather than using additional temperature compensation circuitry, innovative design techniques ensure high performance is built in. As a result, there is essentially no quantization error or nonmonotonic behavior, and temperature hysteresis is very low (typically less than 10 mg over the -40°C to $+125^\circ\text{C}$ temperature range).

Figure 11 shows the 0 g output performance of eight devices (x and y axes) over a -40°C to $+125^\circ\text{C}$ temperature range.

Figure 13 demonstrates the typical sensitivity shift over temperature for $V_s = 5\text{ V}$. Sensitivity stability is optimized for $V_s = 5\text{ V}$ but is still very good over the specified range; it is typically better than $\pm 1\%$ over temperature at $V_s = 3\text{ V}$.

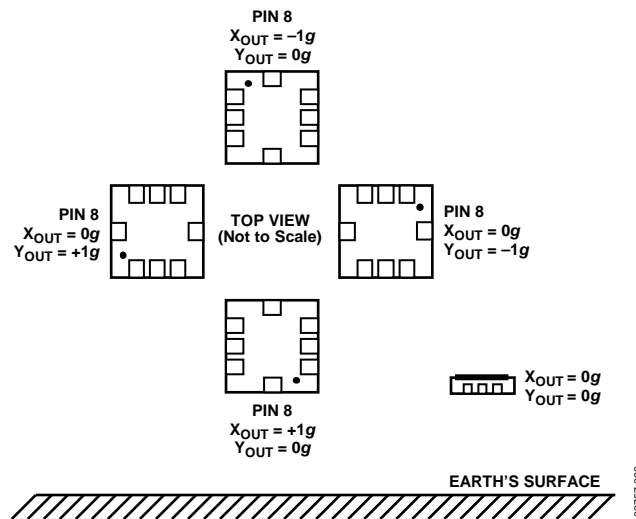

Figure 39. Output Response vs. Orientation

APPLICATIONS INFORMATION

POWER SUPPLY DECOUPLING

For most applications, a single 0.1 μF capacitor, C_{DC}, adequately decouples the accelerometer from noise on the power supply. However, in some cases, particularly where noise is present at the 140 kHz internal clock frequency (or any harmonic thereof), noise on the supply can cause interference on the ADXL103/ADXL203 output. If additional decoupling is needed, a 100 Ω (or smaller) resistor or ferrite beads can be inserted in the supply line of the ADXL103/ADXL203. Additionally, a larger bulk bypass capacitor (in the 1 μF to 22 μF range) can be added in parallel to C_{DC}.

SETTING THE BANDWIDTH USING C_X AND C_Y

The ADXL103/ADXL203 has provisions for band limiting the X_{OUT} and Y_{OUT} pins. Capacitors must be added at these pins to implement low-pass filtering for antialiasing and noise reduction. The equation for the 3 dB bandwidth is

$$f_{-3\text{dB}} = 1/(2\pi(32\text{ k}\Omega) \times C_{(X,Y)})$$

or more simply,

$$f_{-3\text{dB}} = 5\ \mu\text{F}/C_{(X,Y)}$$

The tolerance of the internal resistor (R_{FILT}) can vary typically as much as ±25% of its nominal value (32 kΩ); thus, the bandwidth varies accordingly. A minimum capacitance of 2000 pF for C_X and C_Y is required in all cases.

Table 7. Filter Capacitor Selection, C_X and C_Y

Bandwidth (Hz)	Capacitor (μF)
1	4.7
10	0.47
50	0.10
100	0.05
200	0.027
500	0.01

SELF TEST

The ST pin controls the self test feature. When this pin is set to V_S, an electrostatic force is exerted on the beam of the accelerometer. The resulting movement of the beam allows the user to test if the accelerometer is functional. The typical change in output is 750 mg (corresponding to 750 mV). This pin can be left open-circuit or connected to common in normal use.

Never expose the ST pin to voltages greater than V_S + 0.3 V. If the system design is such that this condition cannot be guaranteed (that is, multiple supply voltages are present), a low V_F clamping diode between ST and V_S is recommended.

DESIGN TRADE-OFFS FOR SELECTING FILTER CHARACTERISTICS: THE NOISE/BANDWIDTH TRADE-OFF

The accelerometer bandwidth selected ultimately determines the measurement resolution (smallest detectable acceleration). Filtering can lower the noise floor, improving the resolution of the accelerometer. Resolution is dependent on the analog filter bandwidth at X_{OUT} and Y_{OUT}.

The output of the ADXL103/ADXL203 has a typical bandwidth of 2.5 kHz. The user must filter the signal at this point to limit aliasing errors. The analog bandwidth must be no more than half the analog-to-digital sampling frequency to minimize aliasing. The analog bandwidth can be further decreased to reduce noise and improve resolution.

The ADXL103/ADXL203 noise has the characteristics of white Gaussian noise, which contributes equally at all frequencies and is described in terms of μg/√Hz (that is, the noise is proportional to the square root of the accelerometer bandwidth). Limit bandwidth to the lowest frequency needed by the application to maximize the resolution and dynamic range of the accelerometer.

With the single-pole roll-off characteristic, the typical noise of the ADXL103/ADXL203 is determined by

$$rmsNoise = (110\ \mu\text{g}/\sqrt{\text{Hz}}) \times (\sqrt{\text{BW} \times 1.6})$$

At 100 Hz, the noise is

$$rmsNoise = (110\ \mu\text{g}/\sqrt{\text{Hz}}) \times (\sqrt{100 \times 1.6}) = 1.4\ \text{mg}$$

Often, the peak value of the noise is desired. Peak-to-peak noise can only be estimated by statistical methods. Table 8 is useful for estimating the probabilities of exceeding various peak values, given the rms value.

Table 8. Estimation of Peak-to-Peak Noise

Peak-to-Peak Value	% of Time That Noise Exceeds Nominal Peak-to-Peak Value
2 × rms	32
4 × rms	4.6
6 × rms	0.27
8 × rms	0.006

Peak-to-peak noise values give the best estimate of the uncertainty in a single measurement; peak-to-peak noise is estimated by 6 × rms. Table 9 gives the typical noise output of the ADXL103/ADXL203 for various C_X and C_Y values.

Table 9. Filter Capacitor Selection (C_X, C_Y)

Bandwidth (Hz)	C _X , C _Y (μF)	RMS Noise (mg)	Peak-to-Peak Noise Estimate (mg)
10	0.47	0.4	2.6
50	0.1	1.0	6
100	0.047	1.4	8.4
500	0.01	3.1	18.7

USING THE ADXL103/ADXL203 WITH OPERATING VOLTAGES OTHER THAN 5 V

The ADXL103/ADXL203 is tested and specified at $V_S = 5$ V; however, it can be powered with V_S as low as 3 V or as high as 6 V. Some performance parameters change as the supply voltage is varied.

The ADXL103/ADXL203 output is ratiometric, so the output sensitivity (or scale factor) varies proportionally to the supply voltage. At $V_S = 3$ V, the output sensitivity is typically 560 mV/g.

The zero g bias output is also ratiometric, so the zero g output is nominally equal to $V_S/2$ at all supply voltages.

The output noise is not ratiometric but is absolute in volts; therefore, the noise density decreases as the supply voltage increases. This is because the scale factor (mV/g) increases while the noise voltage remains constant. At $V_S = 3$ V, the noise density is typically 190 $\mu\text{g}/\sqrt{\text{Hz}}$.

Self test response in g is roughly proportional to the square of the supply voltage. However, when ratiometricity of sensitivity is factored in with supply voltage, self test response in volts is roughly proportional to the cube of the supply voltage. So at $V_S = 3$ V, the self test response is approximately equivalent to 150 mV or equivalent to 270 mg (typical).

The supply current decreases as the supply voltage decreases. Typical current consumption at $V_{DD} = 3$ V is 450 μA .

USING THE ADXL203 AS A DUAL-AXIS TILT SENSOR

One of the most popular applications of the ADXL203 is tilt measurement. An accelerometer uses the force of gravity as an input vector to determine the orientation of an object in space.

An accelerometer is most sensitive to tilt when its sensitive axis is perpendicular to the force of gravity, that is, parallel to the earth's surface. At this orientation, its sensitivity to changes in tilt is highest. When the accelerometer is oriented on axis to gravity, that is, near its +1 g or -1 g reading, the change in output acceleration per degree of tilt is negligible. When the accelerometer is perpendicular to gravity, its output changes nearly 17.5 mg per degree of tilt. At 45°, its output changes at only 12.2 mg per degree, and resolution declines.

Dual-Axis Tilt Sensor: Converting Acceleration to Tilt

When the accelerometer is oriented so both its x-axis and y-axis are parallel to the earth's surface, it can be used as a 2-axis tilt sensor with a roll axis and a pitch axis. After the output signal from the accelerometer is converted to an acceleration that varies between -1 g and +1 g , the output tilt in degrees is calculated as

$$PITCH = ASIN(A_x/1 g)$$

$$ROLL = ASIN(A_y/1 g)$$

Be sure to account for overranges. It is possible for the accelerometers to output a signal greater than ± 1 g due to vibration, shock, or other accelerations.

OUTLINE DIMENSIONS

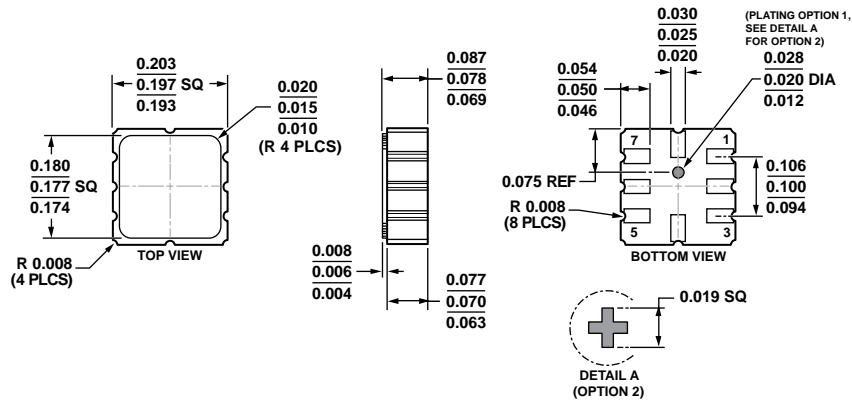

Figure 40. 8-Terminal Ceramic Leadless Chip Carrier [LCC] (E-8-1)
Dimensions shown in inches

ORDERING GUIDE

Model ¹	Axes	Device Generic	g-Range	Specified Voltage (V)	Temperature Range	Package Description	Package Option
ADXL103CE	1	ADXL103	±1.7	5	-40°C to +125°C	8-Terminal Ceramic LCC	E-8-1
ADXL103CE-REEL	1	ADXL103	±1.7	5	-40°C to +125°C	8-Terminal Ceramic LCC	E-8-1
AD22035Z	1	ADXL103	±18	5	-40°C to +125°C	8-Terminal Ceramic LCC	E-8-1
ADXL203CE	2	ADXL203	±1.7	5	-40°C to +125°C	8-Terminal Ceramic LCC	E-8-1
ADXL203CE-REEL	2	ADXL203	±1.7	5	-40°C to +125°C	8-Terminal Ceramic LCC	E-8-1
ADXL203EB						Evaluation Board	
AD22293Z	2	ADXL203	±5	5	-40°C to +125°C	8-Terminal Ceramic LCC	E-8-1
AD22293Z-RL	2	ADXL203	±5	5	-40°C to +125°C	8-Terminal Ceramic LCC	E-8-1
AD22293Z-RL7	2	ADXL203	±5	5	-40°C to +125°C	8-Terminal Ceramic LCC	E-8-1
AD22037Z	2	ADXL203	±18	5	-40°C to +125°C	8-Terminal Ceramic LCC	E-8-1

¹ Z = RoHS Compliant Part.

Компания «Океан Электроники» предлагает заключение долгосрочных отношений при поставках импортных электронных компонентов на взаимовыгодных условиях!

Наши преимущества:

- Поставка оригинальных импортных электронных компонентов напрямую с производств Америки, Европы и Азии, а так же с крупнейших складов мира;
- Широкая линейка поставок активных и пассивных импортных электронных компонентов (более 30 млн. наименований);
- Поставка сложных, дефицитных, либо снятых с производства позиций;
- Оперативные сроки поставки под заказ (от 5 рабочих дней);
- Экспресс доставка в любую точку России;
- Помощь Конструкторского Отдела и консультации квалифицированных инженеров;
- Техническая поддержка проекта, помощь в подборе аналогов, поставка прототипов;
- Поставка электронных компонентов под контролем ВП;
- Система менеджмента качества сертифицирована по Международному стандарту ISO 9001;
- При необходимости вся продукция военного и аэрокосмического назначения проходит испытания и сертификацию в лаборатории (по согласованию с заказчиком);
- Поставка специализированных компонентов военного и аэрокосмического уровня качества (Xilinx, Altera, Analog Devices, Intersil, Interpoint, Microsemi, Actel, Aeroflex, Peregrine, VPT, Syfer, Eurofarad, Texas Instruments, MS Kennedy, Miteq, Cobham, E2V, MA-COM, Hittite, Mini-Circuits, General Dynamics и др.);

Компания «Океан Электроники» является официальным дистрибьютором и эксклюзивным представителем в России одного из крупнейших производителей разъемов военного и аэрокосмического назначения «JONHON», а так же официальным дистрибьютором и эксклюзивным представителем в России производителя высокотехнологичных и надежных решений для передачи СВЧ сигналов «FORSTAR».



JONHON

«JONHON» (основан в 1970 г.)

Разъемы специального, военного и аэрокосмического назначения:

(Применяются в военной, авиационной, аэрокосмической, морской, железнодорожной, горно- и нефтедобывающей отраслях промышленности)

«FORSTAR» (основан в 1998 г.)

ВЧ соединители, коаксиальные кабели, кабельные сборки и микроволновые компоненты:

(Применяются в телекоммуникациях гражданского и специального назначения, в средствах связи, РЛС, а так же военной, авиационной и аэрокосмической отраслях промышленности).



Телефон: 8 (812) 309-75-97 (многоканальный)

Факс: 8 (812) 320-03-32

Электронная почта: ocean@oceanchips.ru

Web: <http://oceanchips.ru/>

Адрес: 198099, г. Санкт-Петербург, ул. Калинина, д. 2, корп. 4, лит. А