



### Typical Applications

The HMC631LP3(E) is ideal for:

- Cellular/3G & WiMAX Systems
- Wireless Infrastructure HPA & MPCA Error Correction
- Pre-Distortion or Feed-Forward Linearization
- Beam Forming & Nulling Circuits

### Features

- Continuous Phase Control: 360°
- Continuous Gain Control: 40 dB
- Output Noise Floor: -160 dBm/Hz
- Input IP3: +35 dBm
- 16 Lead 3x3mm SMT Package: 9mm<sup>2</sup>

### Functional Diagram

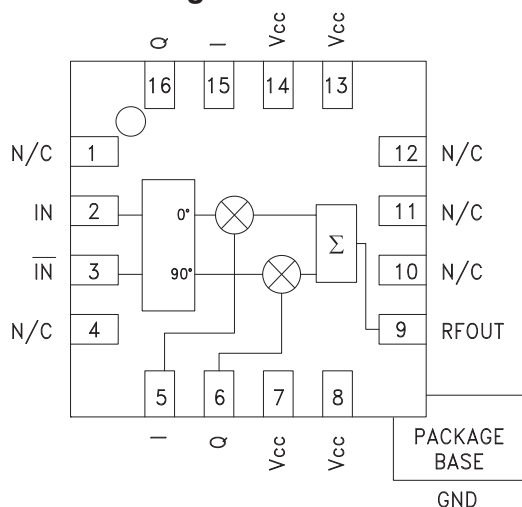

### General Description

The HMC631LP3 & HMC631LP3E are high dynamic range Vector Modulator RFICs which are targeted for RF predistortion and feed-forward cancellation circuits, as well as RF cancellation, beam forming and amplitude/phase correction circuits. The I & Q ports of the HMC631LP3(E) can be used to continuously vary the phase and amplitude of RF signals by up to 360 degrees and 40 dB respectively, while supporting a 3 dB modulation bandwidth of 200 MHz. With an output IP3 of +26 dBm and output noise floor of -160 dBm/Hz (at maximum gain setting), the IP3/noise floor ratio is 186 dB.

10

MODULATORS - SMT

### Electrical Specifications, $T_A = +25^\circ\text{C}$ , $V_{CC} = +8\text{V}$

Parameter	Min.	Typ.	Max.	Min.	Typ.	Max.	Units
Frequency Range		1.8 - 2.2		2.2 - 2.7			GHz
Maximum Gain <sup>(1)</sup>	-11	-9			-11		dB
Gain Variation Over Temperature		0.016	0.025		0.016		dB / °C
Gain Flatness Across Any 60 MHz Bandwidth		0.15			0.4		dB
Gain Range		40			40		dB
Input Return Loss		9			9		dB
Output Return Loss		13			10		dB
Input Power for 1dB Compression (P1dB)	15	18			21		dBm
Input Third Order Intercept (IP3)		35			37		dBm
Output Noise		-160			-160		dBm/Hz
Control Port Bandwidth (-3 dB)		200			200		MHz
Control Port Impedance		1.45k			1.45k		Ohms
Control Port Capacitance		0.22			0.22		pF
Control Voltage Range		+0.5 to +2.5			+0.5 to +2.5		Vdc
Group Delay Variation Over 60 MHz Bandwidth		20			20		ps
Supply Current (I <sub>cc</sub> )		93			93		mA

Unless otherwise noted, measurements are made @ max. gain setting and 45° phase setting. See application circuit for details.

<sup>(1)</sup>Includes loss of input balun (0.8 dB typ.)



**GaAs HBT VECTOR MODULATOR 1.8 - 2.7 MHz**

**Maximum Gain vs. Temperature**

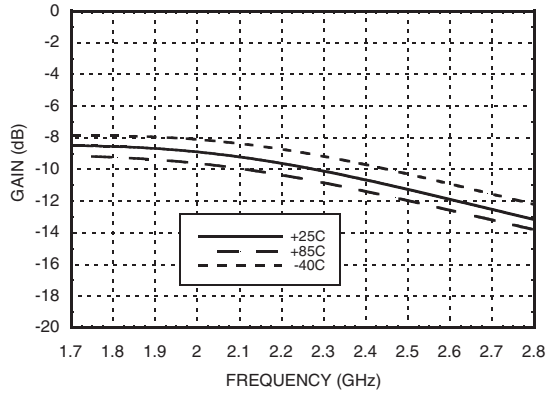

**Maximum Gain vs. Supply Voltage**

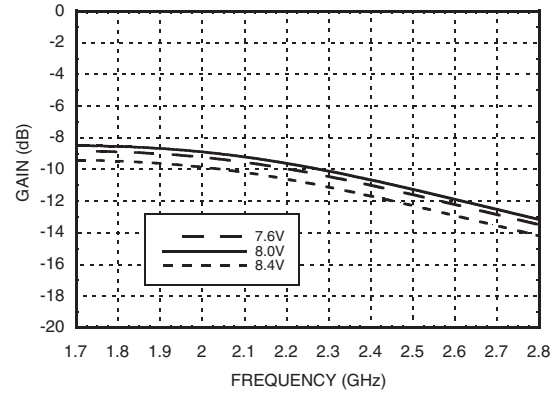

**Gain vs. Phase Settings @ F= 2 GHz**

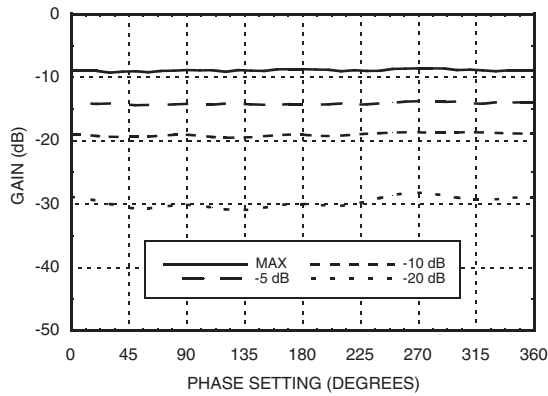

**Phase vs. Phase Settings @ F= 2 GHz vs. Various Gain Settings**

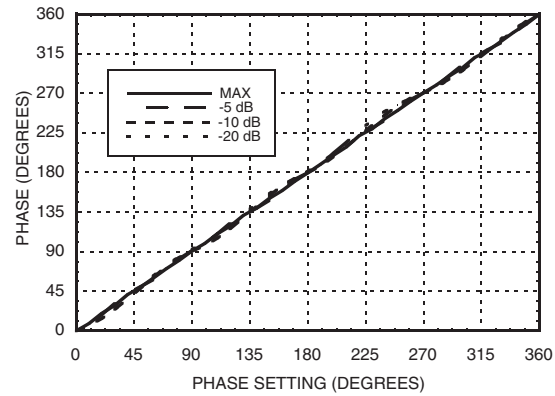

**Input Return Loss vs. Temperature**

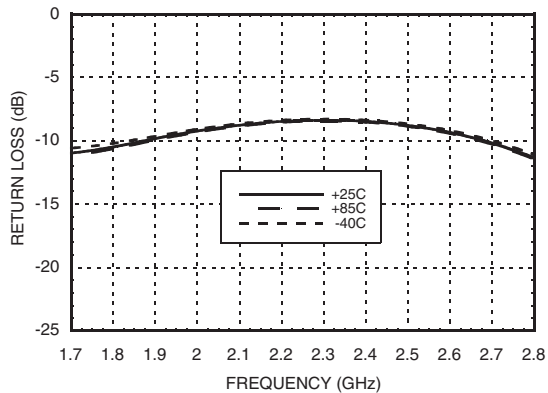

**Output Return Loss vs. Temperature**

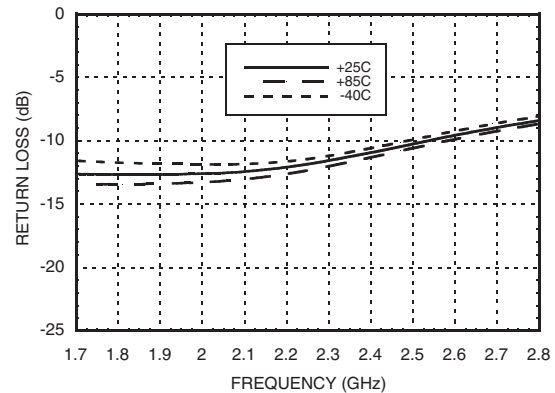

Information furnished by Analog Devices is believed to be accurate and reliable. However, no responsibility is assumed by Analog Devices for its use, nor for any infringements of patents or other rights of third parties that may result from its use. Specifications subject to change without notice. No license is granted by implication or otherwise under any patent or patent rights of Analog Devices. Trademarks and registered trademarks are the property of their respective owners.

For price, delivery, and to place orders: Analog Devices, Inc., One Technology Way, P.O. Box 9106, Norwood, MA 02062-9106 Phone: 781-329-4700 • Order online at [www.analog.com](http://www.analog.com) Application Support: Phone: 1-800-ANALOG-D



**GaAs HBT VECTOR  
MODULATOR 1.8 - 2.7 MHz**

**Output Noise vs. Temperature**

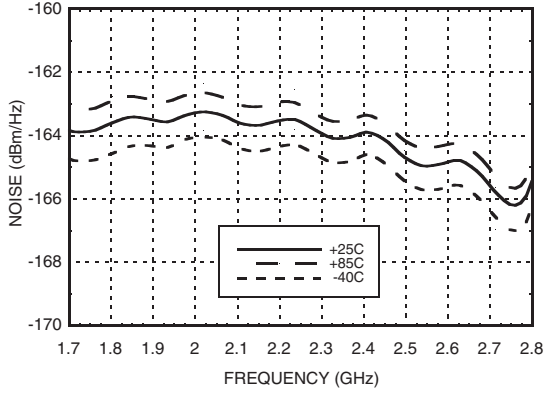

**Output Noise vs. Phase Settings @ F= 2 GHz**

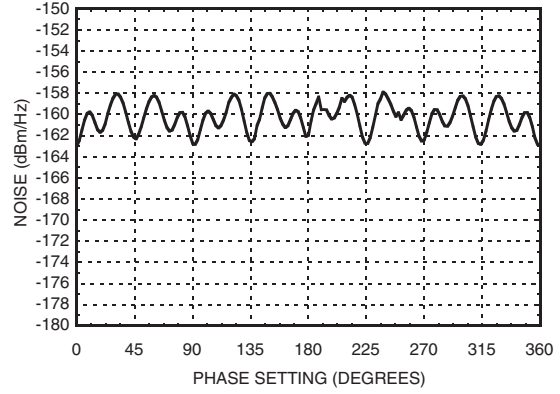

**Input P1dB vs. Temperature**

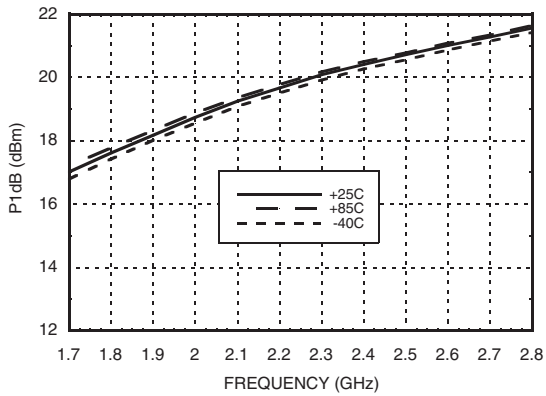

**Input IP3 vs. Temperature**

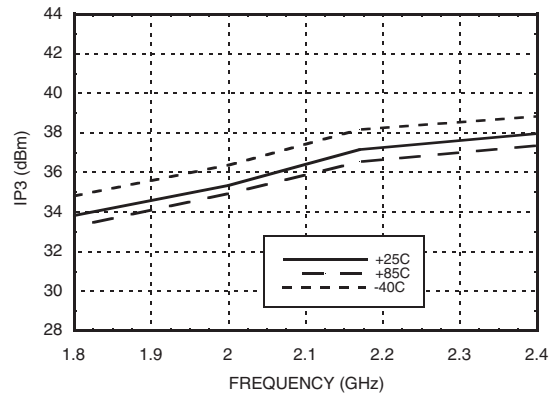

**Group Delay**

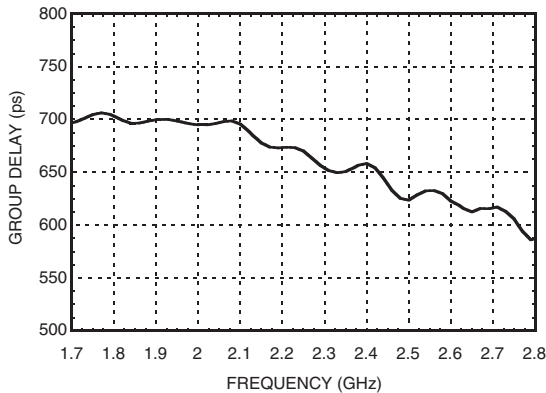

**Linear Gain vs. Phase Setting**

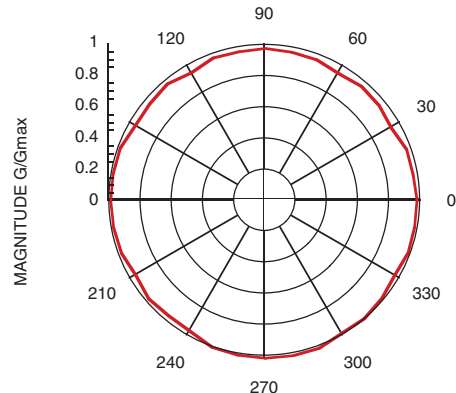

Information furnished by Analog Devices is believed to be accurate and reliable. However, no responsibility is assumed by Analog Devices for its use, nor for any infringements of patents or other rights of third parties that may result from its use. Specifications subject to change without notice. No license is granted by implication or otherwise under any patent or patent rights of Analog Devices. Trademarks and registered trademarks are the property of their respective owners.

For price, delivery, and to place orders: Analog Devices, Inc., One Technology Way, P.O. Box 9106, Norwood, MA 02062-9106 Phone: 781-329-4700 • Order online at [www.analog.com](http://www.analog.com) Application Support: Phone: 1-800-ANALOG-D



### Typical Supply Current vs. Vcc

Vcc (V)	Icc (mA)
7.6	88
8.0	93
8.4	99

Note:  
Modulator will operate over full voltage range shown above.



**ELECTROSTATIC SENSITIVE DEVICE**  
OBSERVE HANDLING PRECAUTIONS

### Absolute Maximum Ratings

RF Input (Vcc = +8V)	27 dBm
Supply Voltage (Vcc)	+10V
I & Q Input	-0.5V to +5V
Junction Temperature (Tc)	135 °C
Continuous P <sub>diss</sub> (T = 85°C) (Derate 34 mW/°C above 85°C)	1.7 W
Thermal Resistance (R <sub>th</sub> ) (junction to ground paddle)	29.6 °C/W
Storage Temperature	-65 to +150 °C
Operating Temperature	-40 to +85 °C

### Outline Drawing

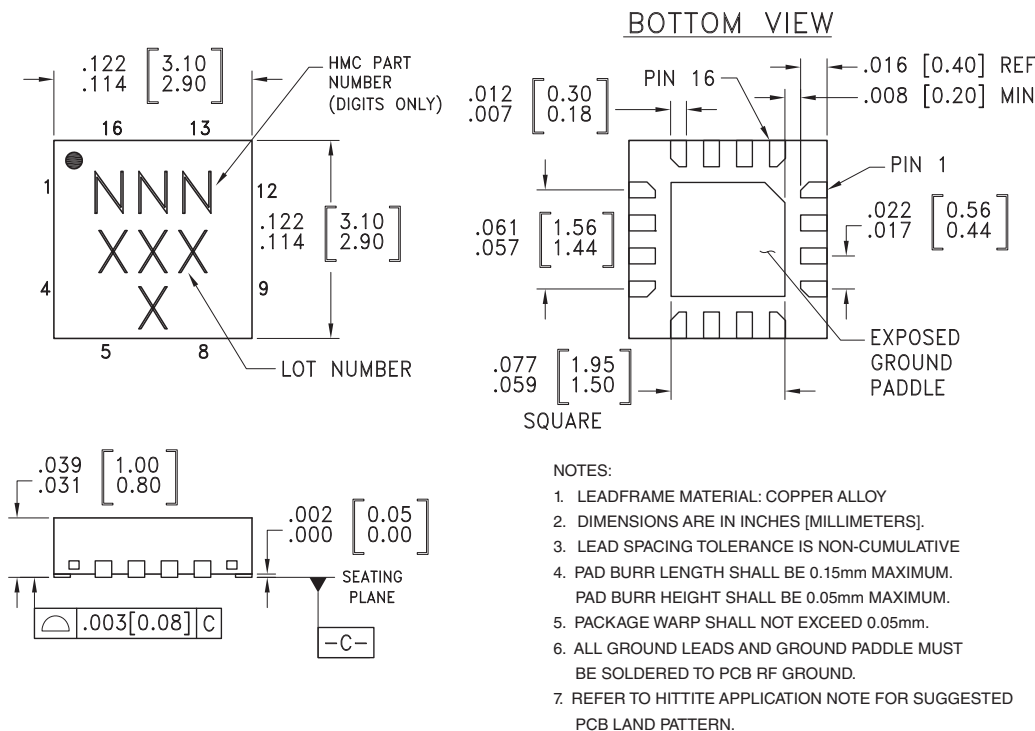

### Package Information

Part Number	Package Body Material	Lead Finish	MSL Rating	Package Marking <sup>[3]</sup>
HMC631LP3	Low Stress Injection Molded Plastic	Sn/Pb Solder	MSL1 <sup>[1]</sup>	631 XXXX
HMC631LP3E	RoHS-compliant Low Stress Injection Molded Plastic	100% matte Sn	MSL1 <sup>[2]</sup>	631 XXXX

[1] Max peak reflow temperature of 235 °C

[2] Max peak reflow temperature of 260 °C

[3] 4-Digit lot number XXXX



### Pin Description

Pin Number	Function	Description	Interface Schematic
1, 4, 10 - 12	N/C	No connection. These pins may be connected to RF ground. Performance will not be affected	
2, 3	IN, $\bar{IN}$	Differential RF inputs, 100 Ohms differential impedance. (i.e. each pin is 50 Ohms to ground). Must be DC blocked.	
5, 15	I	In-phase control input. Pins 5 and 15 are redundant. Either input can be used.	
6, 16	Q	Quadrature control input. Pins 6 and 16 are redundant. Either input can be used.	
7, 8, 13, 14	Vcc	Supply Voltage, pins are DC connected on-chip. It is only necessary to supply Vcc to any 1 of the 4 pins, but all 4 pins must be bypassed to ground. (See application circuit).	
9	RFOUT	RF Output: Must be DC blocked.	
	GND	Ground: Backside of package has exposed metal ground paddle which must be connected to RF/DC ground.	



### Application Circuit

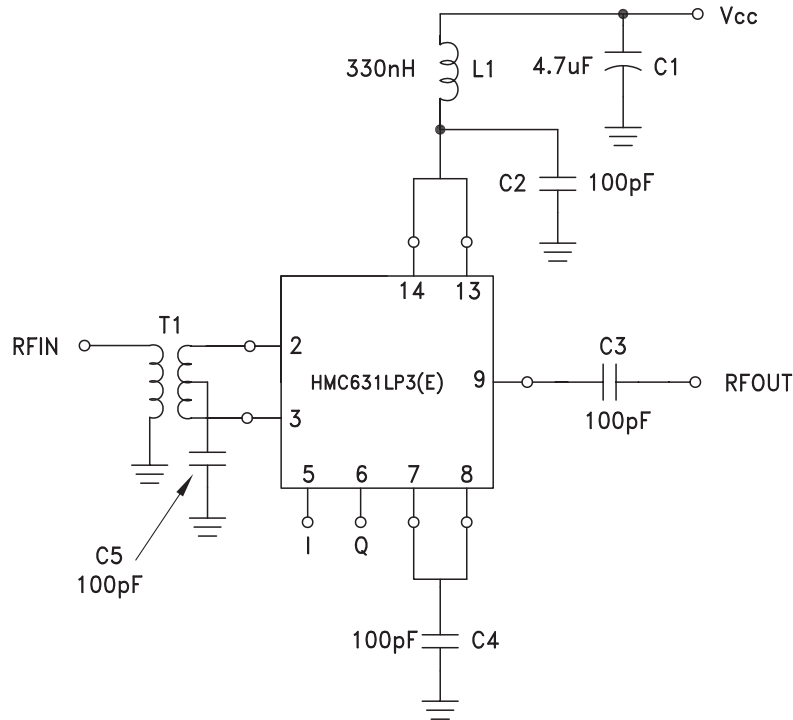

\* Pins 15 & 16 are redundant I & Q inputs.

Gain and Phase control are applied through the I and Q control ports. For a given linear gain (G) and phase ( $\theta$ ) setting, the voltages applied to these ports in all measurements are calculated as follows:

$$I(G, \theta) = V_{mi} + 1.0V \frac{G}{G_{max}} \cos(\theta)$$

$$Q(G, \theta) = V_{mq} + 1.0V \frac{G}{G_{max}} \sin(\theta)$$

Where  $V_{mi}$  and  $V_{mq}$  are the I and Q voltage settings corresponding to maximum isolation at room temperature and  $F = 2$  GHz.

Note that  $G = 10^x$  and  $G_{max} = 10^y$  where  $x = \frac{\text{Gain Setting (dB)}}{20}$  and  $y = \frac{\text{Max Gain Setting (dB)}}{20}$ . Nominally  $V_{mi} = V_{mq} = 1.5V$ ,  $G_{max} = 0.316$ .



**GaAs HBT VECTOR  
MODULATOR 1.8 - 2.7 MHz**

**Evaluation PCB**

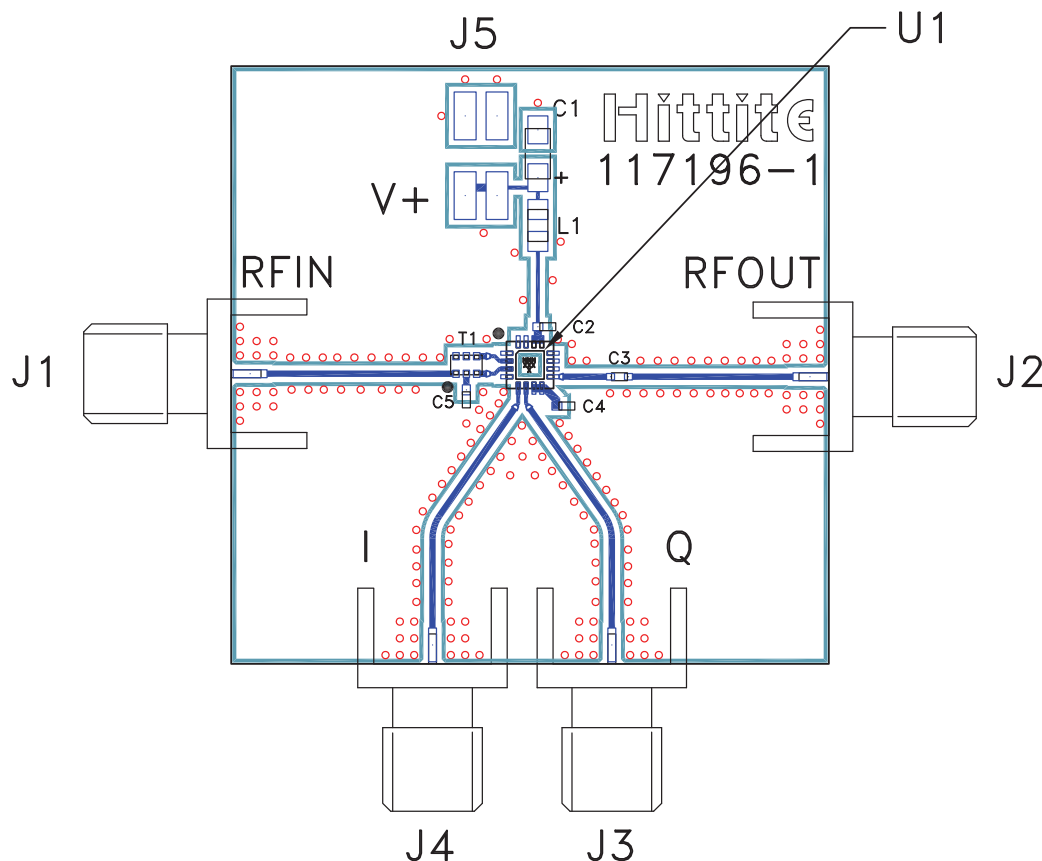

**List of Materials for Evaluation PCB 117201 [1]**

Item	Description
J1 - J4	PCB Mount SMA Connector
J5	2 mm DC Header
C1	4.7 $\mu$ F Capacitor, Tantalum
C2 - C5	100 pF Capacitor, 0402 Pkg.
T1	Balun, 0805 Pkg. ANAREN BD1722J50100A
L1	330 nH Inductor, 0805 Pkg.
U1	HMC631LP3(E) Vector Modulator
PCB [2]	117196 Evaluation PCB

[1] Reference this number when ordering complete evaluation PCB

[2] Circuit Board Material: Rogers 4350, Er = 3.48

The circuit board used in the final application should use RF circuit design techniques. Signal lines should have 50 ohm impedance while the package ground leads and exposed paddle should be connected directly to the ground plane similar to that shown. A sufficient number of via holes should be used to connect the top and bottom ground planes. The evaluation board should be mounted to an appropriate heat sink. The evaluation circuit board shown is available from Hittite upon request.



**Notes:**

v00.1007

## HMC631LP3 / 631LP3E

**GaAs HBT VECTOR  
MODULATOR 1.8 - 2.7 MHz**

10

MODULATORS - SMT

Information furnished by Analog Devices is believed to be accurate and reliable. However, no responsibility is assumed by Analog Devices for its use, nor for any infringements of patents or other rights of third parties that may result from its use. Specifications subject to change without notice. No license is granted by implication or otherwise under any patent or patent rights of Analog Devices. Trademarks and registered trademarks are the property of their respective owners.

For price, delivery, and to place orders: Analog Devices, Inc.,  
One Technology Way, P.O. Box 9106, Norwood, MA 02062-9106  
Phone: 781-329-4700 • Order online at [www.analog.com](http://www.analog.com)  
Application Support: Phone: 1-800-ANALOG-D



Компания «Океан Электроники» предлагает заключение долгосрочных отношений при поставках импортных электронных компонентов на взаимовыгодных условиях!

Наши преимущества:

- Поставка оригинальных импортных электронных компонентов напрямую с производств Америки, Европы и Азии, а так же с крупнейших складов мира;
- Широкая линейка поставок активных и пассивных импортных электронных компонентов (более 30 млн. наименований);
- Поставка сложных, дефицитных, либо снятых с производства позиций;
- Оперативные сроки поставки под заказ (от 5 рабочих дней);
- Экспресс доставка в любую точку России;
- Помощь Конструкторского Отдела и консультации квалифицированных инженеров;
- Техническая поддержка проекта, помощь в подборе аналогов, поставка прототипов;
- Поставка электронных компонентов под контролем ВП;
- Система менеджмента качества сертифицирована по Международному стандарту ISO 9001;
- При необходимости вся продукция военного и аэрокосмического назначения проходит испытания и сертификацию в лаборатории (по согласованию с заказчиком);
- Поставка специализированных компонентов военного и аэрокосмического уровня качества (Xilinx, Altera, Analog Devices, Intersil, Interpoint, Microsemi, Actel, Aeroflex, Peregrine, VPT, Syfer, Eurofarad, Texas Instruments, MS Kennedy, Miteq, Cobham, E2V, MA-COM, Hittite, Mini-Circuits, General Dynamics и др.);

Компания «Океан Электроники» является официальным дистрибьютором и эксклюзивным представителем в России одного из крупнейших производителей разъемов военного и аэрокосмического назначения «JONHON», а так же официальным дистрибьютором и эксклюзивным представителем в России производителя высокотехнологичных и надежных решений для передачи СВЧ сигналов «FORSTAR».



## JONHON

«JONHON» (основан в 1970 г.)

Разъемы специального, военного и аэрокосмического назначения:

(Применяются в военной, авиационной, аэрокосмической, морской, железнодорожной, горно- и нефтедобывающей отраслях промышленности)

«FORSTAR» (основан в 1998 г.)

ВЧ соединители, коаксиальные кабели, кабельные сборки и микроволновые компоненты:

(Применяются в телекоммуникациях гражданского и специального назначения, в средствах связи, РЛС, а так же военной, авиационной и аэрокосмической отраслях промышленности).



Телефон: 8 (812) 309-75-97 (многоканальный)

Факс: 8 (812) 320-03-32

Электронная почта: [ocean@oceanchips.ru](mailto:ocean@oceanchips.ru)

Web: <http://oceanchips.ru/>

Адрес: 198099, г. Санкт-Петербург, ул. Калинина, д. 2, корп. 4, лит. А