

### Product Overview

The QPB7464 is a GaAs pHEMT 75-ohm RF differential amplifier with an operating bandwidth from 47 MHz to 1.218 GHz. Featuring 12 dB of flat gain for use in Broadband DOCSIS 3.1 applications. This MMIC uses a 5-volt supply and is offered in an 8-pin SOIC.



SOIC-8 Package

### Functional Block Diagram

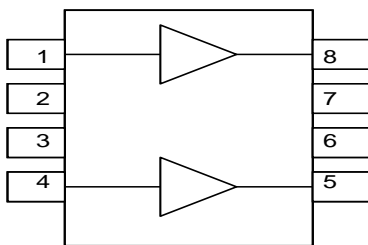

Top View

### Key Features

- 47 – 1218 MHz Bandwidth
- 75  $\Omega$  Impedance
- Meets DOCSIS 3.1 Output Requirements
- +5 V Supply Voltage
- 240 mA Current Consumption
- SOIC – 8 package
- +37 dBm OIP3
- +23.6 dBm OP1dB
- 12 dB Gain

### Applications

- DOCSIS 3.1 systems
- HFC Optical Nodes and Amplifiers
- MDU Output
- Cable TV Network Equipment

### Ordering Information

Part Number	Description
QPB7464SB	Sample bag with 5 pieces
QPB7464SR	7" Reel with 100 pieces
QPB7464TR13	13" Reel with 2500 pieces
QPB7464PCK401	47 – 1218 MHz PCBA

## Absolute Maximum Ratings

Parameter	Rating
Supply Voltage ( $V_{DD}$ )	+10 V
Supply Current ( $I_{DD}$ )	300 mA
Maximum Input Level (single tone)	+12 dBm
Operating Temperature Range	-40 to +100 °C
Storage Temperature Range	-65 to +165 °C
Maximum Junction Temperature	+150 °C

Exceeding any one or a combination of the Absolute Maximum Rating conditions may cause permanent damage to the device. Extended application of Absolute Maximum Rating condition to the device may reduce device reliability.

## Electrical Specifications

Parameter	Condition	Min	Typ	Max	Unit
Supply Voltage ( $V_{DD}$ )			5		V
Supply Current ( $I_{DD}$ )			240		mA
Frequency Range		47		1218	MHz
Gain	1218 MHz		12.3		dB
Gain Flatness	Max. deviation from line using least squares fit from 47 to 1218 MHz		± 0.1dB		dB
Gain Slope	Gain (1218 MHz) – Gain (50 MHz)		0.2		dB
Reverse Isolation			17.5		dB
Input Return Loss			17.2		dB
Output Return Loss			16.1		dB
Noise Figure	1218 MHz		3.8		dB
OIP2	Low band: 200 MHz, 30 MHz spacing, 6 dBm/tone		77.3		dBm
	High band: 1100 MHz, 30 MHz spacing, 6 dBm/tone		53.6		dBm
OIP3	Low band: 200 MHz, 6 MHz spacing, 6 dBm/tone		40.1		dBm
	High band: 1100 MHz, 6 MHz spacing, 6 dBm/tone		39.3		dBm
Output P1dB	1218 MHz		23.6		dBm
Thermal Resistance	$\Theta_{JC}$ (Junction to Case)		14		°C/W

Notes:

1. Typical performance at these conditions: Temp = +25 °C,  $V_{DD}$  = +5 V, 75 Ω system, Full band unless otherwise noted

### Evaluation Board Schematic

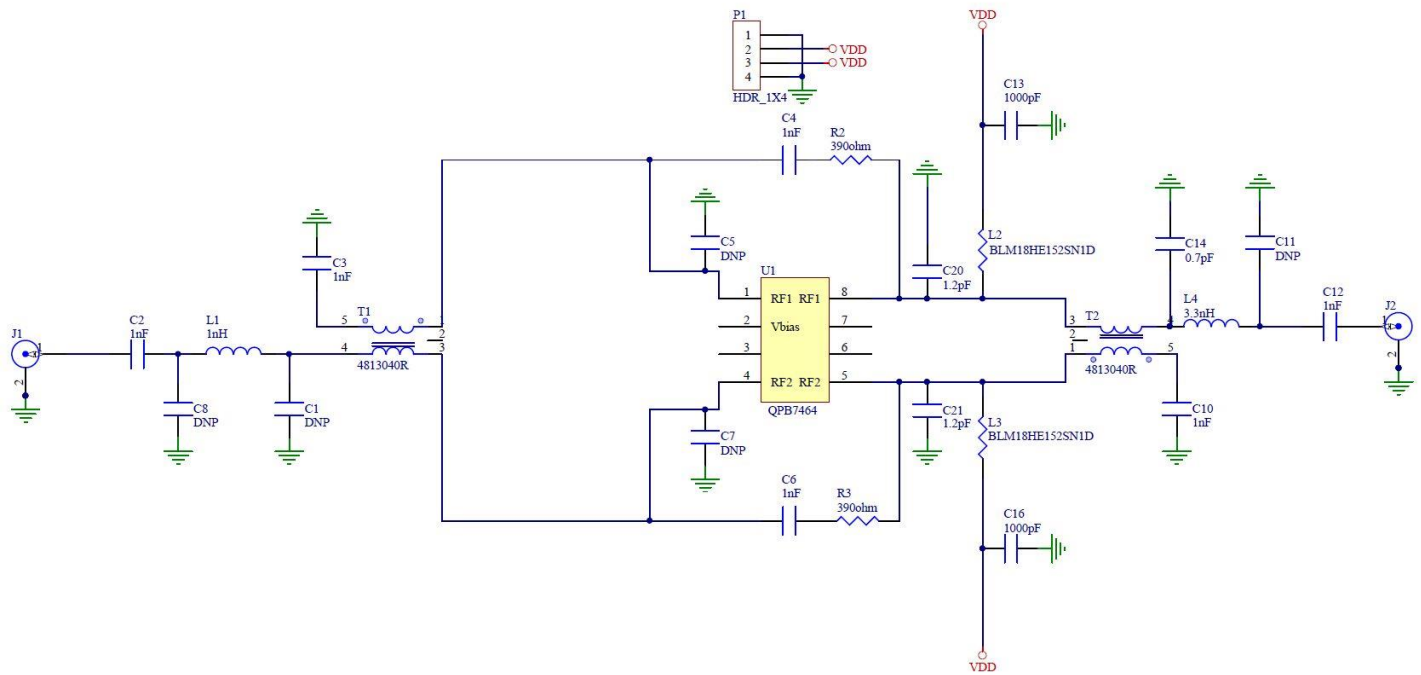



### Evaluation Board Bill of Materials

Ref Designator	Description	Manufacturer	P/N
U1	QPB7464 pHEMT Dual RF Amplifier	Qorvo	QPB7464
PCB	QPB74XX-4000	Viasystems Technologies Corp LLC	
C2, C3, C10, C12	CAP, 1000 pF, 5 %, 50 V, C0G, 0402	Murata Electronics	GRM1555C1H102JA01D
C4, C6, C13, C16	CAP, 1000 pF, 50 V, 10%, 0603	AVX Asia Ltd.	06035C102KAT2A
C14	CAP, 0.7 pF, +/-0.1 pF, 16 V, HI-Q, 0402	Taiyo Uden PTE Ltd.	RV EVK105CH0R7BW-F
C20, C21	CAP, 1.2 pF, +/-0.1 pF, 200 V, Hi-Q, 0402	ATC	600L1R2BT200T
J1, J2	CONN, F FEM EDGE MOUNT, 75 $\Omega$ , 0.068"	Millimeter Wave Technologies, LLC	MW-846-C-DD-75
L1	IND, 1 nH, 5 %, W/W, 0402	Coilcraft, Inc.	0402CS-1N0XJLW
L2, L3	FER, BEAD, 1500 $\Omega$ , 500 mA, 0603	Murata Electronics	BLM18HE152SN1D
L4	IND, 3.3 nH, 2 %, 1.7 A, W/W, 0402	Coilcraft, Inc.	0402HP-3N3XGLW
P1	CONN, HDR, ST, FRCTN LOCK, 4-PIN	Molex	22-23-2041
R2, R3	RES, 390 $\Omega$ , 5 %, 1/16W, 0603	Panasonic	ERJ-3GEYJ391
T1, T2	Balun	Minntronix	4813040R
C1, C5, C7, C8, C11	Not Populated		

**Evaluation Board Assembly Drawing**

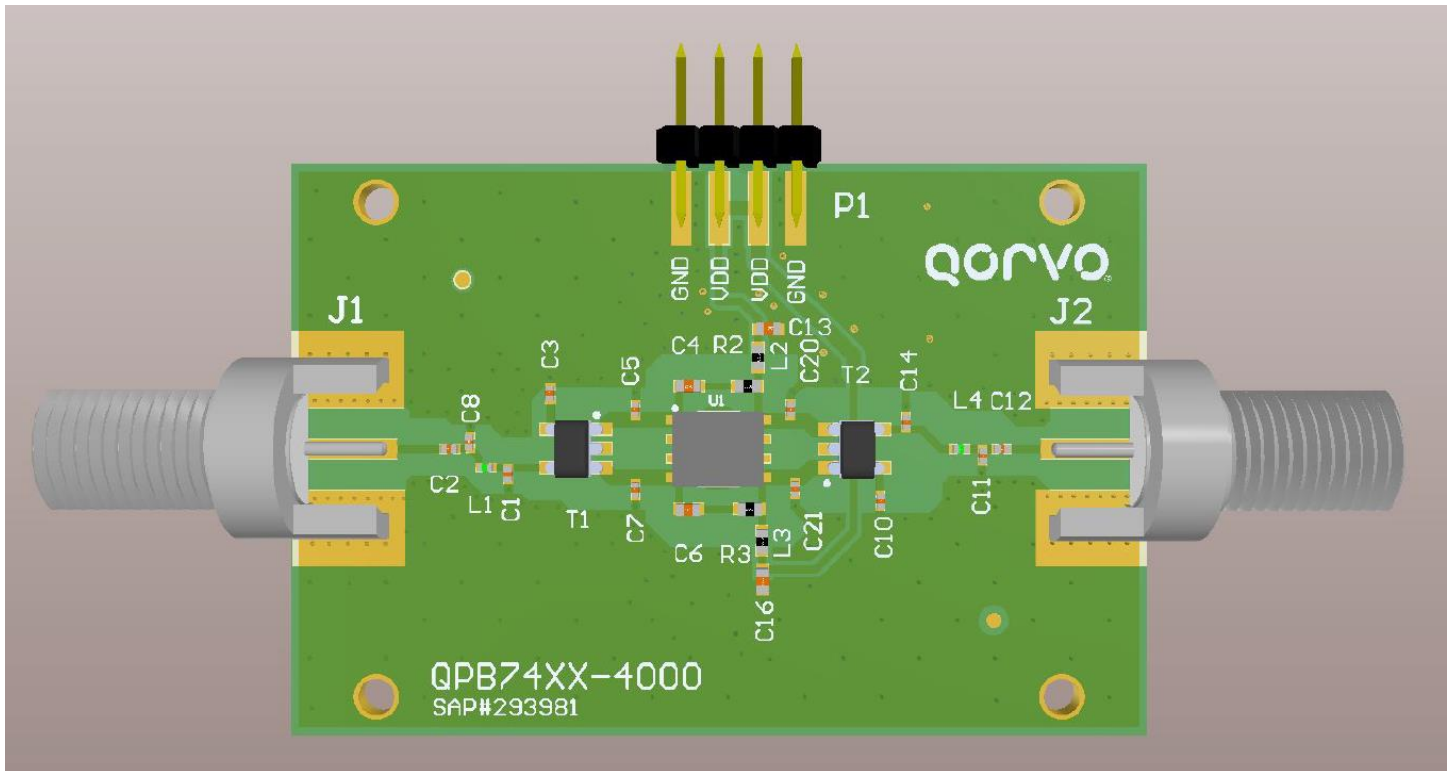

**EVB PCB Material and Stack-up**

Board Material: 0.058" FR4,  $\epsilon_r=4.2$   
 Plating: 0.5oz Copper  
 Board Dimension: 2.25" x 1.5"

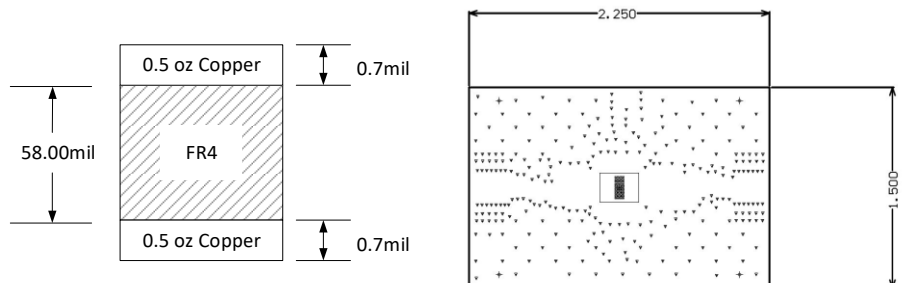

### Typical Application Schematic

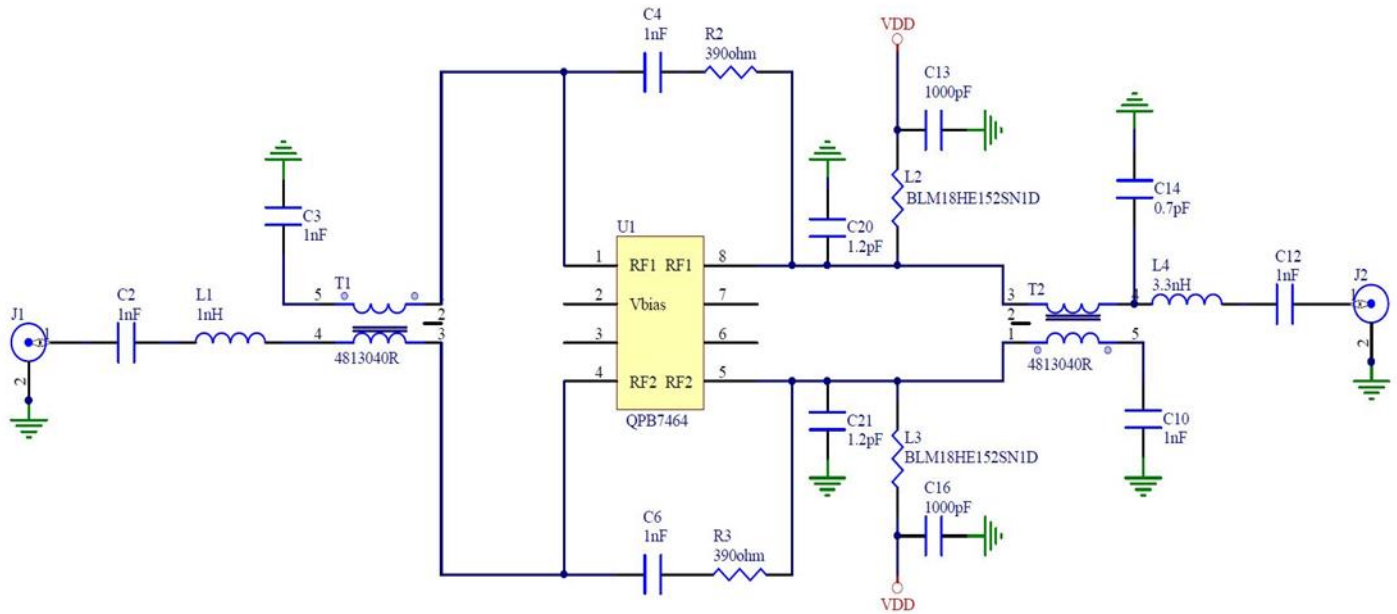

**Performance Data**

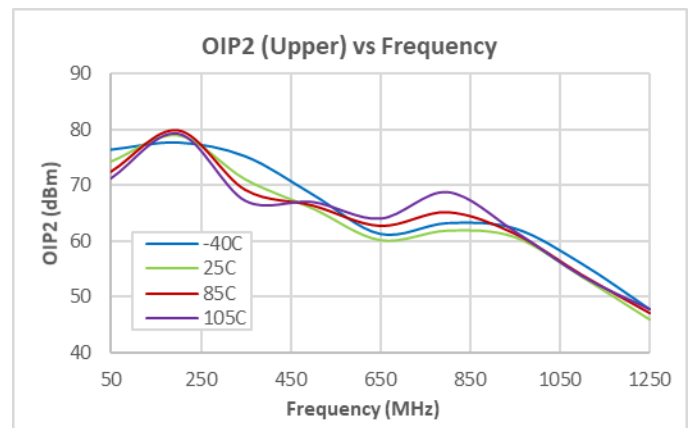
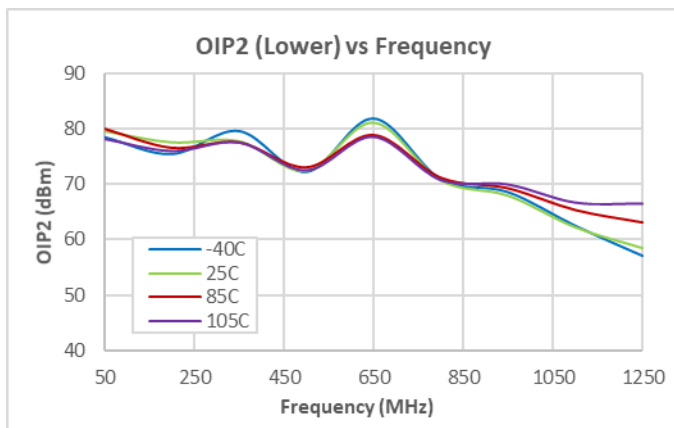
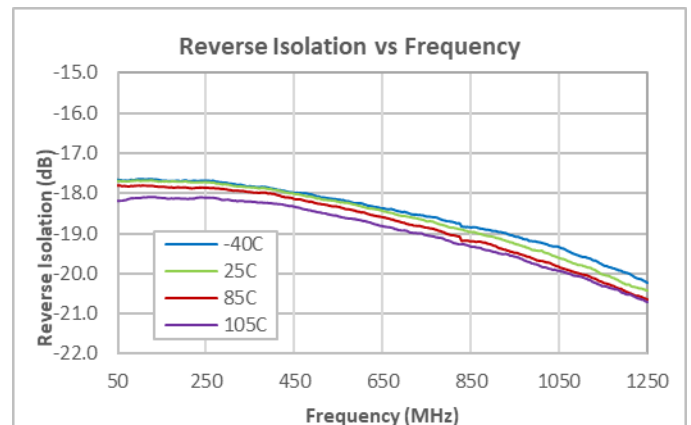
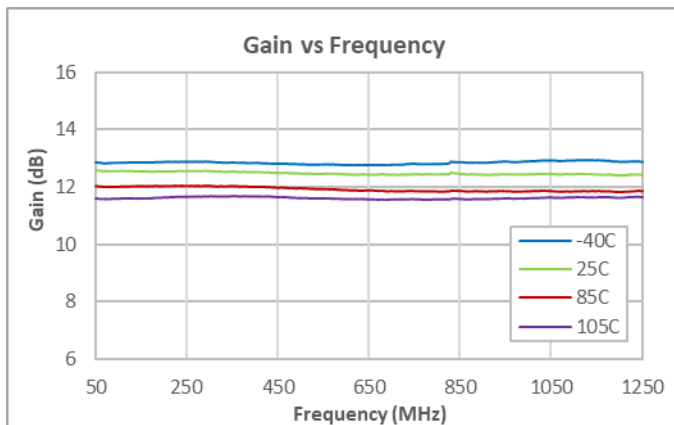
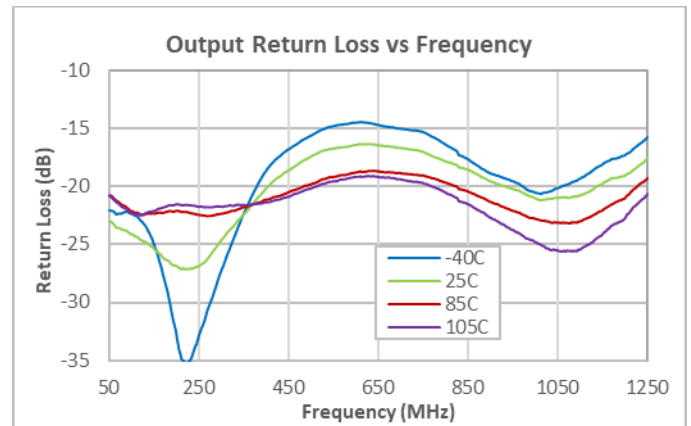
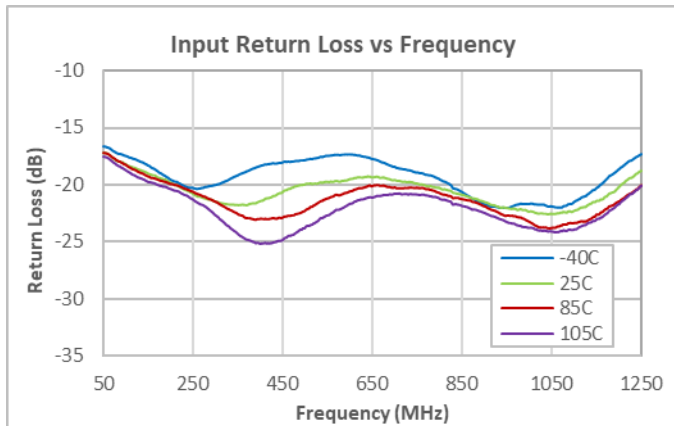

**Test Conditions:**

1. Test conditions unless otherwise noted:  $V_{DD} = +5V$ ,  $Z_0 = 75\Omega$
2. OIP2: +6 dBm per Output Tone.

**Performance Data (cont'd)**

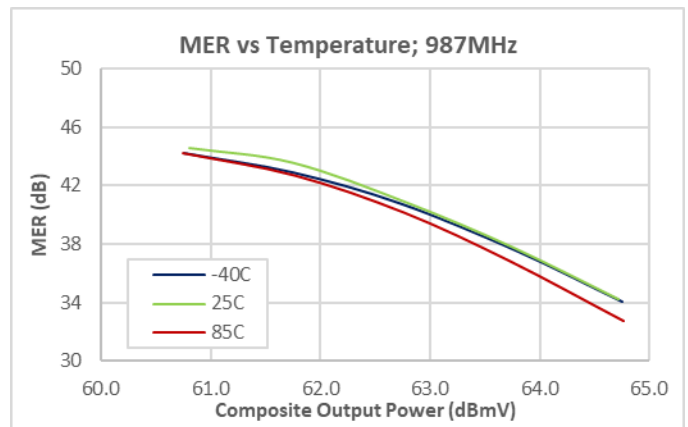
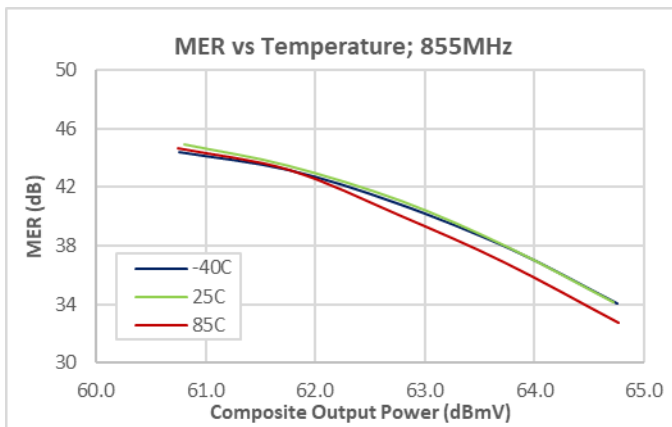
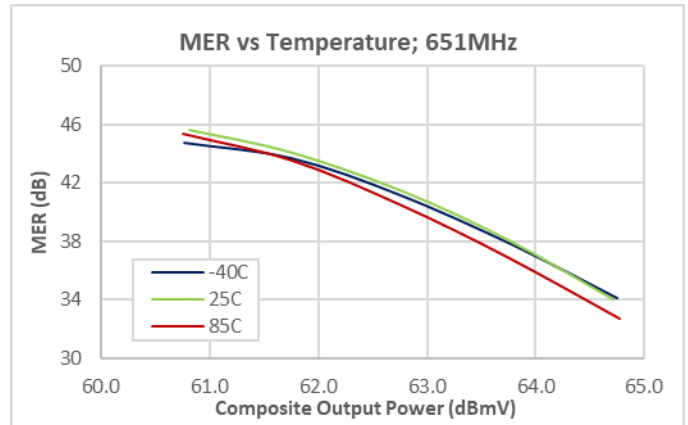
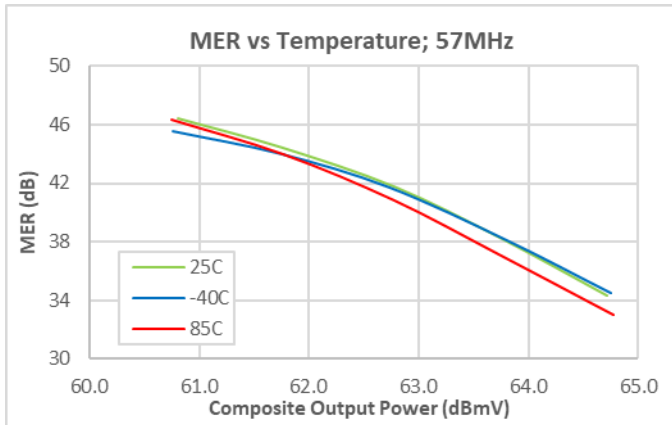
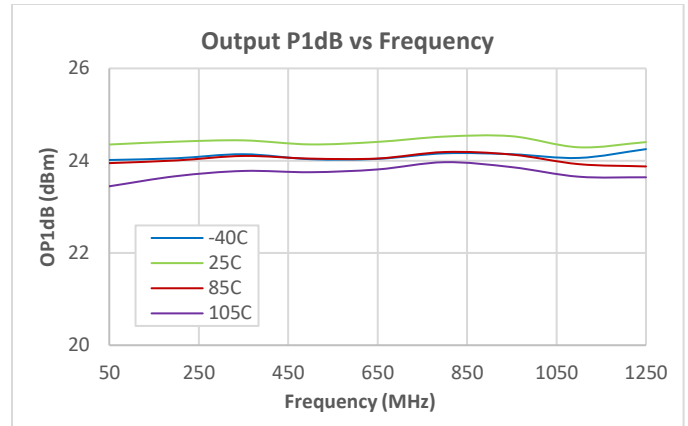
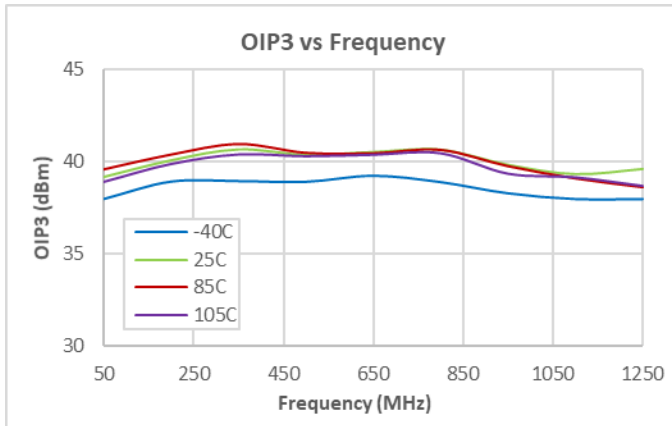

**Test Conditions:**

1. Test conditions unless otherwise noted:  $V_{DD} = +5V$ ,  $Z_o = 75\ \Omega$
2. OIP3: +6 dBm per Output Tone.
3. MER: 190 QAM256 Channels Flat Tilt, 57 – 1215 MHz, ITU-T J.83, Annex B



**Performance Data (cont'd)**

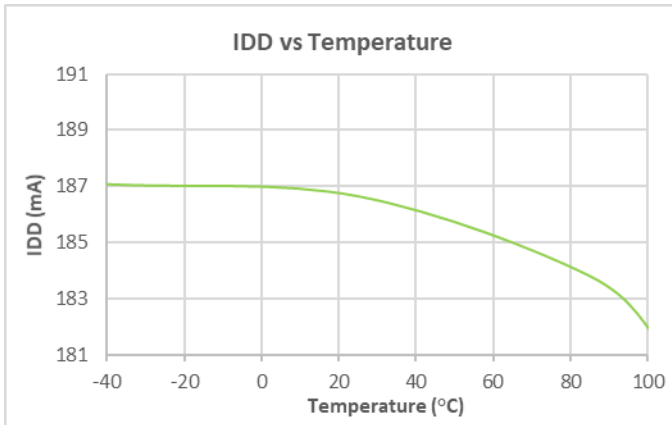
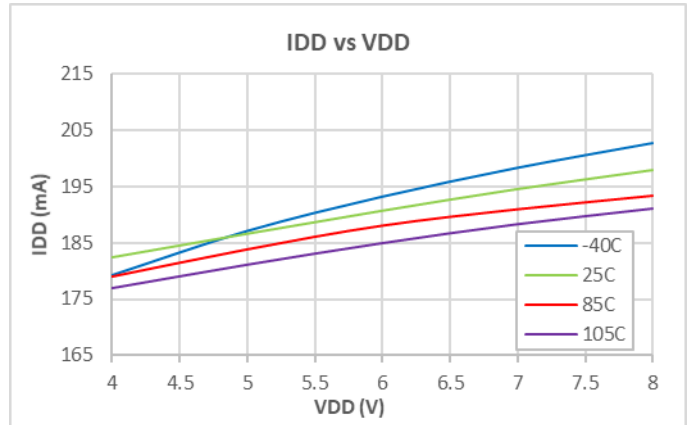
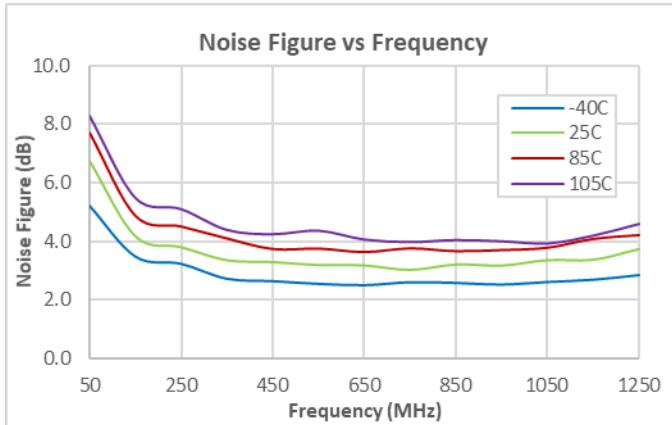
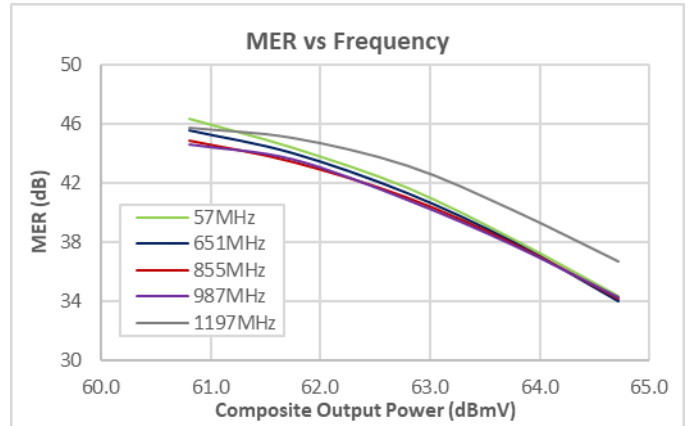
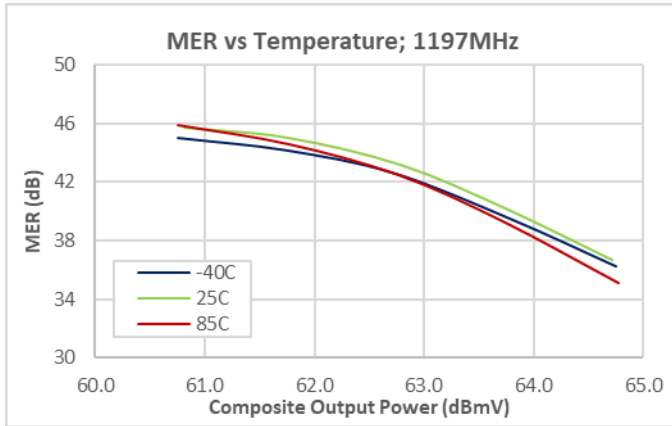

**Test Conditions:**

1. Test conditions unless otherwise noted:  $V_{DD} = +5V$ ,  $Z_o = 75\Omega$
2. MER: 190 QAM256 Channels Flat Tilt, 57 – 1215 MHz, ITU-T J.83, Annex B

## Pin Configuration and Description

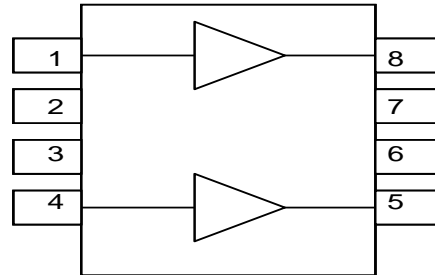

Top View

Pin Number	Label	Description
1	RF <sub>INA</sub>	RF Input A. DC blocking capacitor required.
2	NC	Not Connected
3	NC	Not Connected
4	RF <sub>INB</sub>	RF Input B. DC blocking capacitor required.
5	RF <sub>OUTB</sub> / V <sub>DD</sub>	RF Output B.
6	NC	Not Connected
7	NC	Not Connected
8	RF <sub>OUTA</sub> / V <sub>DD</sub>	RF Output A.
Backside Pad	RF/DC GND	Ground Slug

### Package Outline

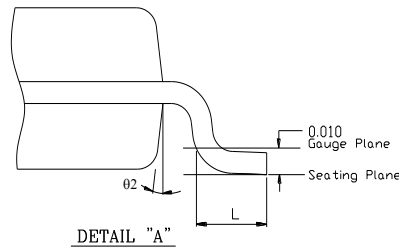
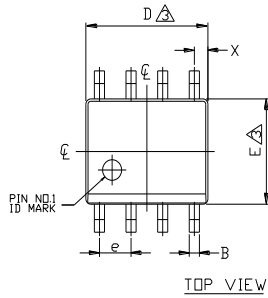

8 SOIC		
SYMBOL	MIN	MAX
A	0.054	0.068
A1	0.001	0.004
B	0.014	0.019
D	0.189	0.197
E	0.150	0.157
H	0.228	0.244
M	0.072	0.097
N	0.067	0.092
e	0.050	BSC
C	0.0070	0.0010
L	0.016	0.050
X	0.0215	REF
θ1	0°	8°
θ2	7°	BSC

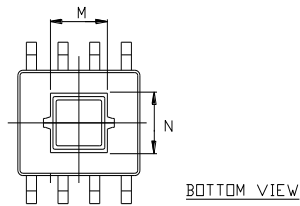
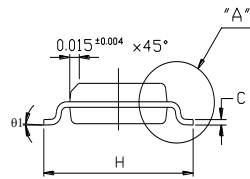
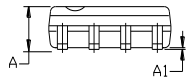

EXPOSED PADDLE

- NOTE :
1. All dimension are in inch
  2. Top package surface to be NiPdAu plating
  3. Bottom package surface to be NiPdAu plating
  4. Dimension are exclusive of mold flash and gate burr
  5. Foot length measurement is based on the gauge plane method

### Package Marking

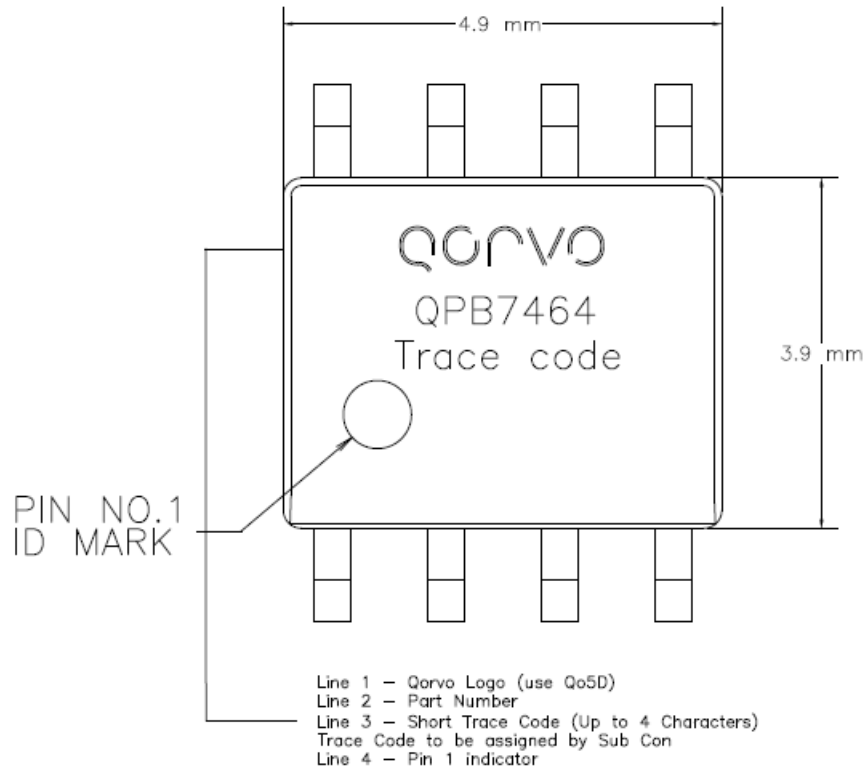

### Recommended Mounting Pattern

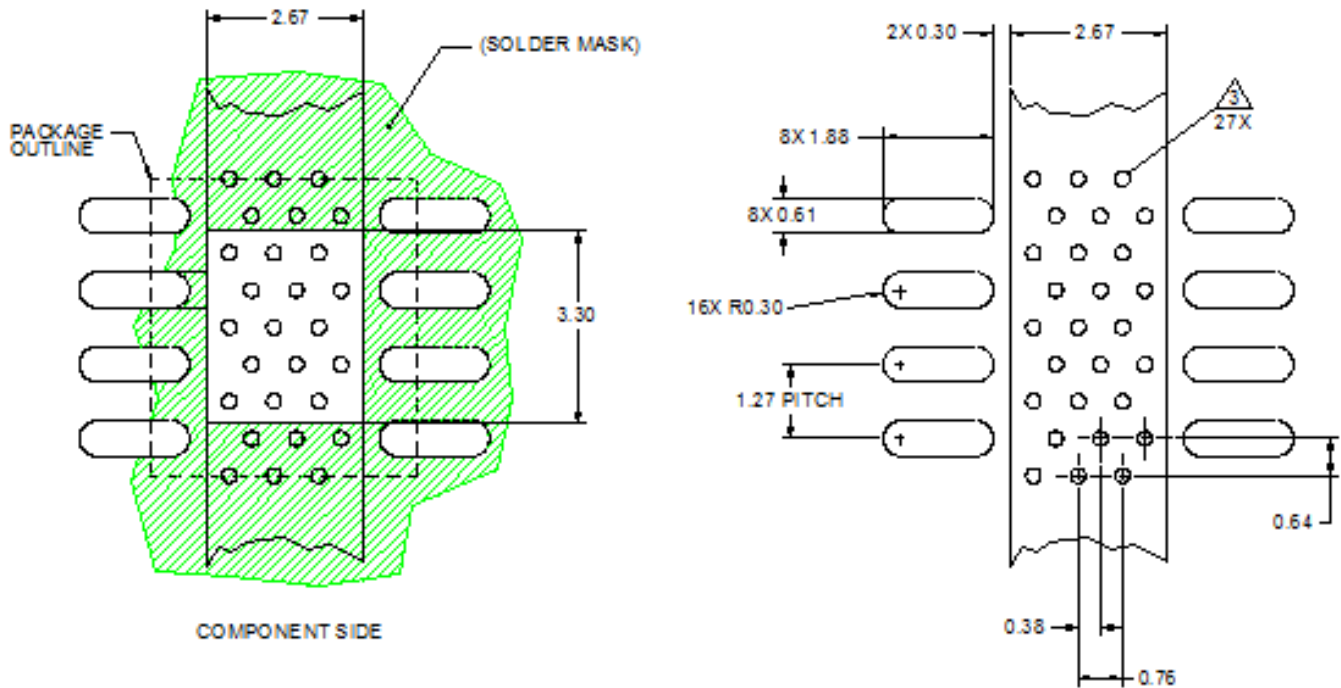

#### Notes:

- All dimensions are in millimeters. Angles are in degrees.
- Use 0.5 oz. copper minimum for top and bottom layer metal.
- Vias are required under the backside paddle of this device for proper RF/DC grounding and thermal dissipation.
- We recommend a 0.35 mm (#80/.0135") diameter bit for drilling via holes and a final plated thru diameter of 0.25 mm (0.010")
- Ensure good package backside paddle solder attach for reliable operation and best electrical performance.

## Handling Precautions

Parameter	Rating	Standard
ESD – Human Body Model (HBM)	Class 1A (500V)	ESDA / JEDEC JS-001-2014
ESD – Charged Device Model (CDM)	Class C3 (1000V)	JEDEC JS-002-2014
MSL – Moisture Sensitivity Level	Level 3	IPC/JEDEC J-STD-020



**Caution!**  
**ESD-Sensitive Device**

## Solderability

Compatible with both lead-free (260 °C max. reflow temp.) and tin / lead (245 °C max. reflow temp.) soldering processes. Solder profiles available upon request.

Contact plating: NiPdAu

## RoHS Compliance

This part is compliant with 2011/65/EU RoHS directive (Restrictions on the Use of Certain Hazardous Substances in Electrical and Electronic Equipment) as amended by Directive 2015/863/EU.

This product also has the following attributes:

- Lead Free
- Halogen Free (Chlorine, Bromine)
- Antimony Free
- TBBP-A (C<sub>15</sub>H<sub>12</sub>Br<sub>4</sub>O<sub>2</sub>) Free
- SVHC Free



## Contact Information

For the latest specifications, additional product information, worldwide sales and distribution locations:

**Tel: 1-844-890-8163**

**Web: [www.qorvo.com](http://www.qorvo.com)**

**Email: [customer.support@qorvo.com](mailto:customer.support@qorvo.com)**

## Important Notice

The information contained herein is believed to be reliable; however, Qorvo makes no warranties regarding the information contained herein and assumes no responsibility or liability whatsoever for the use of the information contained herein. All information contained herein is subject to change without notice. Customers should obtain and verify the latest relevant information before placing orders for Qorvo products. The information contained herein or any use of such information does not grant, explicitly or implicitly, to any party any patent rights, licenses, or any other intellectual property rights, whether with regard to such information itself or anything described by such information. **THIS INFORMATION DOES NOT CONSTITUTE A WARRANTY WITH RESPECT TO THE PRODUCTS DESCRIBED HEREIN, AND QORVO HEREBY DISCLAIMS ANY AND ALL WARRANTIES WITH RESPECT TO SUCH PRODUCTS WHETHER EXPRESS OR IMPLIED BY LAW, COURSE OF DEALING, COURSE OF PERFORMANCE, USAGE OF TRADE OR OTHERWISE, INCLUDING THE IMPLIED WARRANTIES OF MERCHANTABILITY AND FITNESS FOR A PARTICULAR PURPOSE.**

Without limiting the generality of the foregoing, Qorvo products are not warranted or authorized for use as critical components in medical, life-saving, or life-sustaining applications, or other applications where a failure would reasonably be expected to cause severe personal injury or death.

Copyright 2020 © Qorvo, Inc. | Qorvo is a registered trademark of Qorvo, Inc.

Компания «Океан Электроники» предлагает заключение долгосрочных отношений при поставках импортных электронных компонентов на взаимовыгодных условиях!

Наши преимущества:

- Поставка оригинальных импортных электронных компонентов напрямую с производств Америки, Европы и Азии, а так же с крупнейших складов мира;
- Широкая линейка поставок активных и пассивных импортных электронных компонентов (более 30 млн. наименований);
- Поставка сложных, дефицитных, либо снятых с производства позиций;
- Оперативные сроки поставки под заказ (от 5 рабочих дней);
- Экспресс доставка в любую точку России;
- Помощь Конструкторского Отдела и консультации квалифицированных инженеров;
- Техническая поддержка проекта, помощь в подборе аналогов, поставка прототипов;
- Поставка электронных компонентов под контролем ВП;
- Система менеджмента качества сертифицирована по Международному стандарту ISO 9001;
- При необходимости вся продукция военного и аэрокосмического назначения проходит испытания и сертификацию в лаборатории (по согласованию с заказчиком);
- Поставка специализированных компонентов военного и аэрокосмического уровня качества (Xilinx, Altera, Analog Devices, Intersil, Interpoint, Microsemi, Actel, Aeroflex, Peregrine, VPT, Syfer, Eurofarad, Texas Instruments, MS Kennedy, Miteq, Cobham, E2V, MA-COM, Hittite, Mini-Circuits, General Dynamics и др.);

Компания «Океан Электроники» является официальным дистрибьютором и эксклюзивным представителем в России одного из крупнейших производителей разъемов военного и аэрокосмического назначения «**JONHON**», а так же официальным дистрибьютором и эксклюзивным представителем в России производителя высокотехнологичных и надежных решений для передачи СВЧ сигналов «**FORSTAR**».



## JONHON

«**JONHON**» (основан в 1970 г.)

Разъемы специального, военного и аэрокосмического назначения:

(Применяются в военной, авиационной, аэрокосмической, морской, железнодорожной, горно- и нефтедобывающей отраслях промышленности)

«**FORSTAR**» (основан в 1998 г.)

ВЧ соединители, коаксиальные кабели, кабельные сборки и микроволновые компоненты:

(Применяются в телекоммуникациях гражданского и специального назначения, в средствах связи, РЛС, а так же военной, авиационной и аэрокосмической отраслях промышленности).



Телефон: 8 (812) 309-75-97 (многоканальный)

Факс: 8 (812) 320-03-32

Электронная почта: [ocean@oceanchips.ru](mailto:ocean@oceanchips.ru)

Web: <http://oceanchips.ru/>

Адрес: 198099, г. Санкт-Петербург, ул. Калинина, д. 2, корп. 4, лит. А