

**FEATURES**

**Broadband radio frequency (RF), intermediate frequency (IF),  
and local oscillator (LO) ports**

**Conversion loss: 6.8 dB**

**Noise figure: 6.5 dB**

**High input IP3: 25 dBm**

**High input P1dB: 19 dBm**

**Low LO drive level**

**Single-ended design: no need for baluns**

**Single-supply operation: 3 V at 19 mA**

**Miniature, 2 mm × 3 mm, 8-lead LFCSP**

**RoHS compliant**

**APPLICATIONS**

**Cellular base stations**

**Point-to-point radio links**

**RF instrumentation**

**GENERAL DESCRIPTION**

The **ADL5350** is a high linearity, up-and-down converting mixer capable of operating over a broad input frequency range. It is well suited for demanding cellular base station mixer designs that require high sensitivity and effective blocker immunity. Based on a GaAs pHEMT, single-ended mixer architecture, the **ADL5350** provides excellent input linearity and a low noise figure without the need for a high power level LO drive.

In 850 MHz/900 MHz receive applications, the **ADL5350** provides a typical conversion loss of only 6.7 dB. The input IP3 is typically greater than 25 dBm, with an input compression point of 19 dBm. The integrated LO amplifier allows a low LO drive level, typically only 4 dBm for most applications.

**FUNCTIONAL BLOCK DIAGRAM**

Figure 1.

The high input linearity of the **ADL5350** makes the device an excellent mixer for communications systems that require high blocker immunity, such as GSM 850 MHz/900 MHz and 800 MHz CDMA2000. At 2 GHz, a slightly greater supply current is required to obtain similar performance.

The single-ended broadband RF/IF port allows the device to be customized for a desired band of operation using simple external filter networks. The LO-to-RF isolation is based on the LO rejection of the RF port filter network. Greater isolation can be achieved by using higher order filter networks, as described in the Applications Information section.

The **ADL5350** is fabricated on a GaAs pHEMT, high performance IC process. The **ADL5350** is available in a 2 mm × 3 mm, 8-lead LFCSP. It operates over a -40°C to +85°C temperature range. An evaluation board is also available.

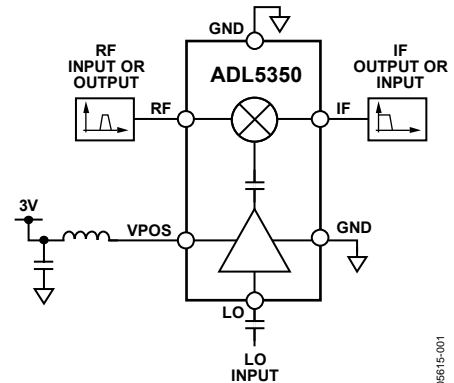
## TABLE OF CONTENTS

|   |   |   |    |
|---|---|---|----|
| Features .....                                    | 1 | Typical Performance Characteristics ..... | 7  |
| Applications .....                                | 1 | 850 MHz Characteristics .....             | 7  |
| Functional Block Diagram .....                    | 1 | 1950 MHz Characteristics .....            | 12 |
| General Description .....                         | 1 | Functional Description .....              | 17 |
| Revision History .....                            | 2 | Circuit Description .....                 | 17 |
| Specifications .....                              | 3 | Implementation Procedure .....            | 17 |
| 850 MHz Receive Performance .....                 | 3 | Applications Information .....            | 19 |
| 1950 MHz Receive Performance .....                | 3 | Low Frequency Applications .....          | 19 |
| Spur Tables .....                                 | 4 | High Frequency Applications .....         | 19 |
| 850 MHz Spur Table .....                          | 4 | Evaluation Board .....                    | 21 |
| 1950 MHz Spur Table .....                         | 4 | Outline Dimensions .....                  | 22 |
| Absolute Maximum Ratings .....                    | 5 | Ordering Guide .....                      | 22 |
| ESD Caution .....                                 | 5 |   |    |
| Pin Configuration and Function Descriptions ..... | 6 |   |    |

## REVISION HISTORY

### 6/2016—Rev. 0 to Rev. A

|  |            |
|--|------------|
| Changed CP-8-1 to CP-8-23 .....                  | Throughout |
| Change to $\theta_{JA}$ Parameter, Table 5 ..... | 5          |
| Changes to Figure 2 and Table 6 .....            | 6          |
| Updated Outline Dimensions .....                 | 22         |
| Changes to Ordering Guide .....                  | 22         |

### 2/2008—Revision 0: Initial Version

## SPECIFICATIONS

### 850 MHz RECEIVE PERFORMANCE

$V_S = 3\text{ V}$ ,  $T_A = 25^\circ\text{C}$ , LO power = 4 dBm, re: 50  $\Omega$ , unless otherwise noted.

Table 1.

| Parameter                          | Min | Typ  | Max | Unit | Test Conditions/Comments  |
|------------------------------------|-----|------|-----|------|---|
| RF Frequency Range                 | 750 | 850  | 975 | MHz  |   |
| LO Frequency Range                 | 500 | 780  | 945 | MHz  | Low-side LO   |
| IF Frequency Range                 | 30  | 70   | 250 | MHz  |   |
| Conversion Loss                    |     | 6.7  |     | dB   | $f_{RF} = 850\text{ MHz}$ , $f_{LO} = 780\text{ MHz}$ , $f_{IF} = 70\text{ MHz}$  |
| SSB Noise Figure                   |     | 6.4  |     | dB   | $f_{RF} = 850\text{ MHz}$ , $f_{LO} = 780\text{ MHz}$ , $f_{IF} = 70\text{ MHz}$  |
| Input Third-Order Intercept (IP3)  |     | 25   |     | dBm  | $f_{RF1} = 849\text{ MHz}$ , $f_{RF2} = 850\text{ MHz}$ , $f_{LO} = 780\text{ MHz}$ , $f_{IF} = 70\text{ MHz}$ ; each RF tone 0 dBm |
| Input 1dB Compression Point (P1dB) |     | 19.8 |     | dBm  | $f_{RF} = 820\text{ MHz}$ , $f_{LO} = 750\text{ MHz}$ , $f_{IF} = 70\text{ MHz}$  |
| LO-to-IF Leakage                   |     | 29   |     | dBc  | LO power = 4 dBm, $f_{LO} = 780\text{ MHz}$   |
| LO-to-RF Leakage                   |     | 13   |     | dBc  | LO power = 4 dBm, $f_{LO} = 780\text{ MHz}$   |
| RF-to-IF Leakage                   |     | 19.5 |     | dBc  | RF power = 0 dBm, $f_{RF} = 850\text{ MHz}$ , $f_{LO} = 780\text{ MHz}$   |
| IF/2 Spurious                      |     | -50  |     | dBc  | RF power = 0 dBm, $f_{RF} = 850\text{ MHz}$ , $f_{LO} = 780\text{ MHz}$   |
| Supply Voltage                     | 2.7 | 3    | 3.5 | V    |   |
| Supply Current                     |     | 16.5 |     | mA   | LO power = 4 dBm  |

### 1950 MHz RECEIVE PERFORMANCE

$V_S = 3\text{ V}$ ,  $T_A = 25^\circ\text{C}$ , LO power = 6 dBm, re: 50  $\Omega$ , unless otherwise noted.

Table 2.

| Parameter                          | Min  | Typ  | Max  | Unit | Test Conditions/Comments  |
|------------------------------------|------|------|------|------|---|
| RF Frequency Range                 | 1800 | 1950 | 2050 | MHz  |   |
| LO Frequency Range                 | 1420 | 1760 | 2000 | MHz  | Low-side LO   |
| IF Frequency Range                 | 50   | 190  | 380  | MHz  |   |
| Conversion Loss                    |      | 6.8  |      | dB   | $f_{RF} = 1950\text{ MHz}$ , $f_{LO} = 1760\text{ MHz}$ , $f_{IF} = 190\text{ MHz}$   |
| SSB Noise Figure                   |      | 6.5  |      | dB   | $f_{RF} = 1950\text{ MHz}$ , $f_{LO} = 1760\text{ MHz}$ , $f_{IF} = 190\text{ MHz}$   |
| Input Third-Order Intercept (IP3)  |      | 25   |      | dBm  | $f_{RF1} = 1949\text{ MHz}$ , $f_{RF2} = 1951\text{ MHz}$ , $f_{LO} = 1760\text{ MHz}$ , $f_{IF} = 190\text{ MHz}$ ; each RF tone 0 dBm |
| Input 1dB Compression Point (P1dB) |      | 19   |      | dBm  | $f_{RF} = 1950\text{ MHz}$ , $f_{LO} = 1760\text{ MHz}$ , $f_{IF} = 190\text{ MHz}$   |
| LO-to-IF Leakage                   |      | 13.5 |      | dBc  | LO power = 6 dBm, $f_{LO} = 1760\text{ MHz}$  |
| LO-to-RF Leakage                   |      | 10.5 |      | dBc  | LO power = 6 dBm, $f_{LO} = 1760\text{ MHz}$  |
| RF-to-IF Leakage                   |      | 11.5 |      | dBc  | RF power = 0 dBm, $f_{RF} = 1950\text{ MHz}$ , $f_{LO} = 1760\text{ MHz}$   |
| IF/2 Spurious                      |      | -54  |      | dBc  | RF power = 0 dBm, $f_{RF} = 1950\text{ MHz}$ , $f_{LO} = 1760\text{ MHz}$   |
| Supply Voltage                     | 2.7  | 3    | 3.5  | V    |   |
| Supply Current                     |      | 19   |      | mA   | LO power = 6 dBm  |

SPUR TABLES

All spur tables are  $(N \times f_{RF}) - (M \times f_{LO})$  mixer spurious products for 0 dBm input power, unless otherwise noted. N.M. indicates that a spur was not measured due to it being at a frequency >6 GHz.

850 MHz SPUR TABLE

Table 3.

|   |    | M     |       |       |       |       |       |       |       |       |       |       |       |       |       |       |       |       |
|---|----|-------|-------|-------|-------|-------|-------|-------|-------|-------|-------|-------|-------|-------|-------|-------|-------|-------|
|   |    | 0     | 1     | 2     | 3     | 4     | 5     | 6     | 7     | 8     | 9     | 10    | 11    | 12    | 13    | 14    | 15    |       |
| N | 0  | ≤-100 | -20.6 | -19.2 | -15.3 | -16.7 | -38.4 | -26.6 | -22.1 | N.M.  | N.M.  | N.M.  | N.M.  | N.M.  | N.M.  | N.M.  | N.M.  |       |
|   | 1  | -21.6 | -5.6  | -23.6 | -19.6 | -31.9 | -28.7 | -46.1 | -48.5 | -33.2 | N.M.  | N.M.  | N.M.  | N.M.  | N.M.  | N.M.  | N.M.  | N.M.  |
|   | 2  | -50.0 | -69.2 | -50.5 | -59.8 | -49.1 | -57.5 | -51.0 | -77.7 | -65.8 | -60.8 | N.M.  | N.M.  | N.M.  | N.M.  | N.M.  | N.M.  | N.M.  |
|   | 3  | -74.8 | -66.0 | -71.8 | -68.1 | -70.2 | -67.4 | -66.9 | -70.8 | -85.2 | -87.3 | -72.2 | N.M.  | N.M.  | N.M.  | N.M.  | N.M.  | N.M.  |
|   | 4  | ≤-100 | -92.6 | -91.6 | -96.1 | -92.7 | -98.7 | -90.2 | -91.7 | -88.8 | ≤-100 | ≤-100 | -91.7 | -88.6 | N.M.  | N.M.  | N.M.  | N.M.  |
|   | 5  | ≤-100 | ≤-100 | ≤-100 | ≤-100 | ≤-100 | ≤-100 | ≤-100 | ≤-100 | ≤-100 | -99.5 | ≤-100 | ≤-100 | ≤-100 | ≤-100 | ≤-100 | N.M.  | N.M.  |
|   | 6  | ≤-100 | ≤-100 | ≤-100 | ≤-100 | ≤-100 | ≤-100 | ≤-100 | ≤-100 | ≤-100 | ≤-100 | ≤-100 | ≤-100 | ≤-100 | ≤-100 | ≤-100 | ≤-100 | N.M.  |
|   | 7  | ≤-100 | ≤-100 | ≤-100 | ≤-100 | ≤-100 | ≤-100 | ≤-100 | ≤-100 | ≤-100 | ≤-100 | ≤-100 | ≤-100 | ≤-100 | ≤-100 | ≤-100 | ≤-100 | ≤-100 |
|   | 8  | N.M.  | N.M.  | ≤-100 | ≤-100 | ≤-100 | ≤-100 | ≤-100 | ≤-100 | ≤-100 | ≤-100 | ≤-100 | ≤-100 | ≤-100 | ≤-100 | ≤-100 | ≤-100 | ≤-100 |
|   | 9  | N.M.  | N.M.  | N.M.  | ≤-100 | ≤-100 | ≤-100 | ≤-100 | ≤-100 | ≤-100 | ≤-100 | ≤-100 | ≤-100 | ≤-100 | ≤-100 | ≤-100 | ≤-100 | ≤-100 |
|   | 10 | N.M.  | N.M.  | N.M.  | N.M.  | ≤-100 | ≤-100 | ≤-100 | ≤-100 | ≤-100 | ≤-100 | ≤-100 | ≤-100 | ≤-100 | ≤-100 | ≤-100 | ≤-100 | ≤-100 |
|   | 11 | N.M.  | N.M.  | N.M.  | N.M.  | N.M.  | ≤-100 | ≤-100 | ≤-100 | ≤-100 | ≤-100 | ≤-100 | ≤-100 | ≤-100 | ≤-100 | ≤-100 | ≤-100 | ≤-100 |
|   | 12 | N.M.  | N.M.  | N.M.  | N.M.  | N.M.  | N.M.  | ≤-100 | ≤-100 | ≤-100 | ≤-100 | ≤-100 | ≤-100 | ≤-100 | ≤-100 | ≤-100 | ≤-100 | ≤-100 |
|   | 13 | N.M.  | N.M.  | N.M.  | N.M.  | N.M.  | N.M.  | N.M.  | ≤-100 | ≤-100 | ≤-100 | ≤-100 | ≤-100 | ≤-100 | ≤-100 | ≤-100 | ≤-100 | ≤-100 |
|   | 14 | N.M.  | N.M.  | N.M.  | N.M.  | N.M.  | N.M.  | N.M.  | N.M.  | ≤-100 | ≤-100 | ≤-100 | ≤-100 | ≤-100 | ≤-100 | ≤-100 | ≤-100 | ≤-100 |
|   | 15 | N.M.  | N.M.  | N.M.  | N.M.  | N.M.  | N.M.  | N.M.  | N.M.  | N.M.  | ≤-100 | ≤-100 | ≤-100 | ≤-100 | ≤-100 | ≤-100 | ≤-100 | ≤-100 |

05615-008

1950 MHz SPUR TABLE

Table 4.

|   |    | M     |       |       |       |       |       |       |       |       |       |       |       |       |       |       |       |       |
|---|----|-------|-------|-------|-------|-------|-------|-------|-------|-------|-------|-------|-------|-------|-------|-------|-------|-------|
|   |    | 0     | 1     | 2     | 3     | 4     | 5     | 6     | 7     | 8     | 9     | 10    | 11    | 12    | 13    | 14    | 15    |       |
| N | 0  | ≤-100 | -13.1 | -32.8 | -22.4 | N.M.  | N.M.  | N.M.  | N.M.  | N.M.  | N.M.  | N.M.  | N.M.  | N.M.  | N.M.  | N.M.  | N.M.  |       |
|   | 1  | -10.8 | -7.0  | -25.3 | -27.7 | -33.9 | N.M.  | N.M.  | N.M.  | N.M.  | N.M.  | N.M.  | N.M.  | N.M.  | N.M.  | N.M.  | N.M.  | N.M.  |
|   | 2  | -48.2 | -61.2 | -41.2 | -44.6 | -47.0 | -74.6 | N.M.  | N.M.  | N.M.  | N.M.  | N.M.  | N.M.  | N.M.  | N.M.  | N.M.  | N.M.  | N.M.  |
|   | 3  | -72.3 | -71.4 | -83.6 | -64.5 | -62.4 | -64.3 | -83.7 | N.M.  | N.M.  | N.M.  | N.M.  | N.M.  | N.M.  | N.M.  | N.M.  | N.M.  | N.M.  |
|   | 4  | N.M.  | N.M.  | -91.4 | -84.2 | -78.3 | -76.5 | -80.0 | -92.0 | N.M.  | N.M.  | N.M.  | N.M.  | N.M.  | N.M.  | N.M.  | N.M.  | N.M.  |
|   | 5  | N.M.  | N.M.  | N.M.  | -90.8 | -82.3 | -77.1 | -79.5 | -83.8 | -95.2 | N.M.  | N.M.  | N.M.  | N.M.  | N.M.  | N.M.  | N.M.  | N.M.  |
|   | 6  | N.M.  | N.M.  | N.M.  | N.M.  | ≤-100 | ≤-100 | -93.4 | -94.5 | ≤-100 | -99.2 | ≤-100 | N.M.  | N.M.  | N.M.  | N.M.  | N.M.  | N.M.  |
|   | 7  | N.M.  | N.M.  | N.M.  | N.M.  | N.M.  | ≤-100 | ≤-100 | -94.0 | -96.4 | ≤-100 | ≤-100 | ≤-100 | N.M.  | N.M.  | N.M.  | N.M.  | N.M.  |
|   | 8  | N.M.  | N.M.  | N.M.  | N.M.  | N.M.  | N.M.  | ≤-100 | ≤-100 | ≤-100 | ≤-100 | ≤-100 | ≤-100 | ≤-100 | ≤-100 | N.M.  | N.M.  | N.M.  |
|   | 9  | N.M.  | N.M.  | N.M.  | N.M.  | N.M.  | N.M.  | N.M.  | ≤-100 | ≤-100 | ≤-100 | ≤-100 | ≤-100 | ≤-100 | ≤-100 | ≤-100 | N.M.  | N.M.  |
|   | 10 | N.M.  | N.M.  | N.M.  | N.M.  | N.M.  | N.M.  | N.M.  | N.M.  | ≤-100 | ≤-100 | ≤-100 | ≤-100 | ≤-100 | ≤-100 | ≤-100 | ≤-100 | N.M.  |
|   | 11 | N.M.  | N.M.  | N.M.  | N.M.  | N.M.  | N.M.  | N.M.  | N.M.  | N.M.  | ≤-100 | ≤-100 | ≤-100 | ≤-100 | ≤-100 | ≤-100 | ≤-100 | ≤-100 |
|   | 12 | N.M.  | N.M.  | N.M.  | N.M.  | N.M.  | N.M.  | N.M.  | N.M.  | N.M.  | N.M.  | ≤-100 | ≤-100 | ≤-100 | ≤-100 | ≤-100 | ≤-100 | ≤-100 |
|   | 13 | N.M.  | N.M.  | N.M.  | N.M.  | N.M.  | N.M.  | N.M.  | N.M.  | N.M.  | N.M.  | N.M.  | ≤-100 | ≤-100 | ≤-100 | ≤-100 | ≤-100 | ≤-100 |
|   | 14 | N.M.  | N.M.  | N.M.  | N.M.  | N.M.  | N.M.  | N.M.  | N.M.  | N.M.  | N.M.  | N.M.  | N.M.  | ≤-100 | ≤-100 | ≤-100 | ≤-100 | ≤-100 |
|   | 15 | N.M.  | N.M.  | N.M.  | N.M.  | N.M.  | N.M.  | N.M.  | N.M.  | N.M.  | N.M.  | N.M.  | N.M.  | N.M.  | ≤-100 | ≤-100 | ≤-100 | ≤-100 |

05615-008

## ABSOLUTE MAXIMUM RATINGS

Table 5.

| Parameter                    | Rating          |
|------------------------------|-----------------|
| Supply Voltage, $V_s$        | 4.0 V           |
| RF Input Level               | 23 dBm          |
| LO Input Level               | 20 dBm          |
| Internal Power Dissipation   | 324 mW          |
| $\theta_{JA}$                | 33.2°C/W        |
| Maximum Junction Temperature | 135°C           |
| Operating Temperature Range  | -40°C to +85°C  |
| Storage Temperature Range    | -65°C to +150°C |

Stresses at or above those listed under Absolute Maximum Ratings may cause permanent damage to the product. This is a stress rating only; functional operation of the product at these or any other conditions above those indicated in the operational section of this specification is not implied. Operation beyond the maximum operating conditions for extended periods may affect product reliability.

### ESD CAUTION



**ESD (electrostatic discharge) sensitive device.** Charged devices and circuit boards can discharge without detection. Although this product features patented or proprietary protection circuitry, damage may occur on devices subjected to high energy ESD. Therefore, proper ESD precautions should be taken to avoid performance degradation or loss of functionality.

## PIN CONFIGURATION AND FUNCTION DESCRIPTIONS

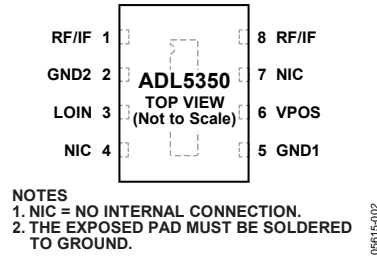

Figure 2. Pin Configuration

Table 6. Pin Function Descriptions

| Pin No. | Mnemonic   | Description   |
|---------|------------|---|
| 1, 8    | RF/IF      | RF and IF Input/Output Ports. These nodes are internally tied together. RF and IF port separation is achieved using external tuning networks.                   |
| 2, 5    | GND2, GND1 | Device Commons (DC Grounds).  |
| 3       | LOIN       | LO Input. Needs to be ac-coupled.   |
| 4, 7    | NIC        | No Internal Connection. Grounding NIC pins is recommended.  |
| 6       | VPOS       | Positive Supply Voltage for the Drain of the LO Buffer. A series RF choke is needed on the supply line to provide proper ac loading of the LO buffer amplifier. |
| 0       | EPAD       | Exposed Pad. The exposed pad must be soldered to ground.  |

# TYPICAL PERFORMANCE CHARACTERISTICS

## 850 MHz CHARACTERISTICS

Supply voltage = 3 V, RF frequency = 850 MHz, IF frequency = 70 MHz, RF level = 0 dBm, LO level = 4 dBm,  $T_A = 25^\circ\text{C}$ , unless otherwise noted.

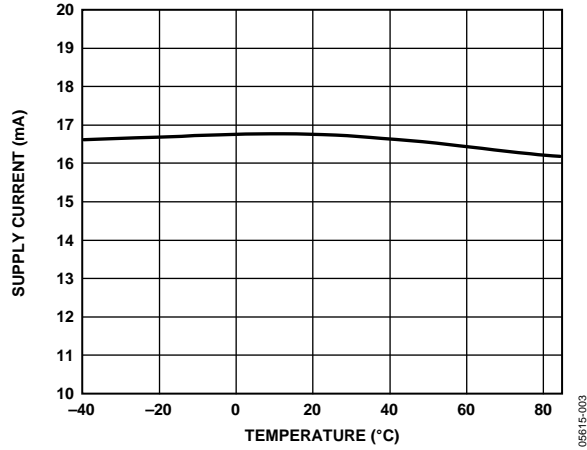

Figure 3. Supply Current vs. Temperature

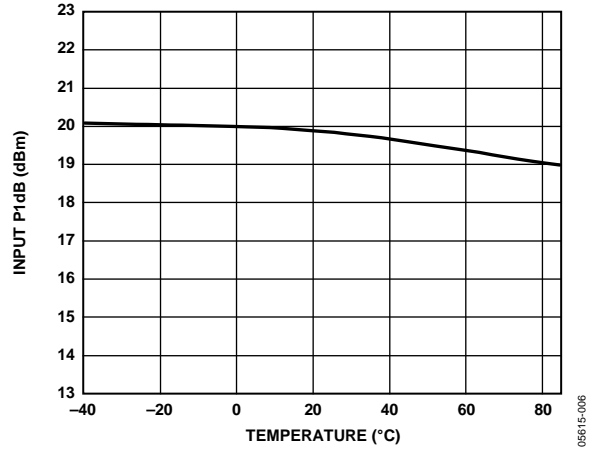

Figure 6. Input P1dB vs. Temperature

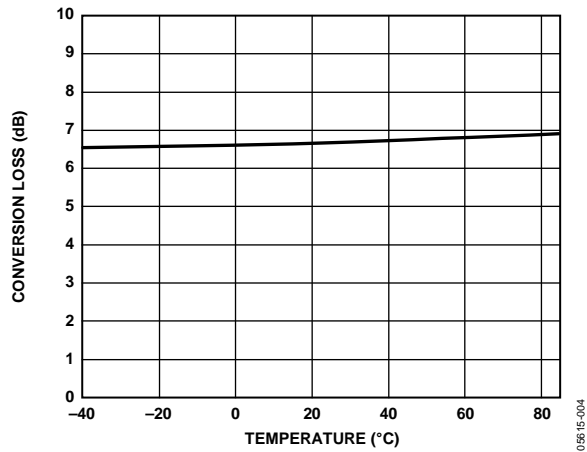

Figure 4. Conversion Loss vs. Temperature

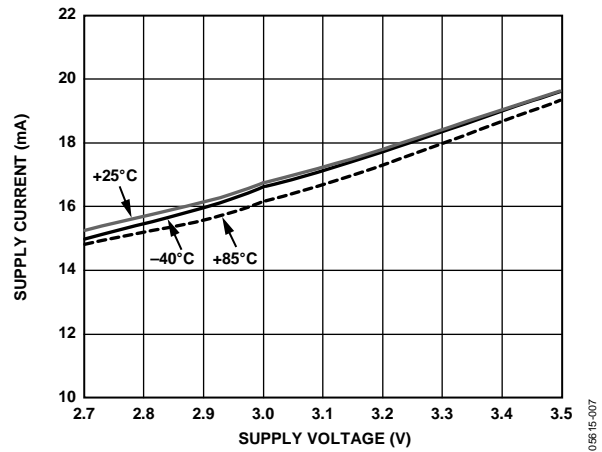

Figure 7. Supply Current vs. Supply Voltage

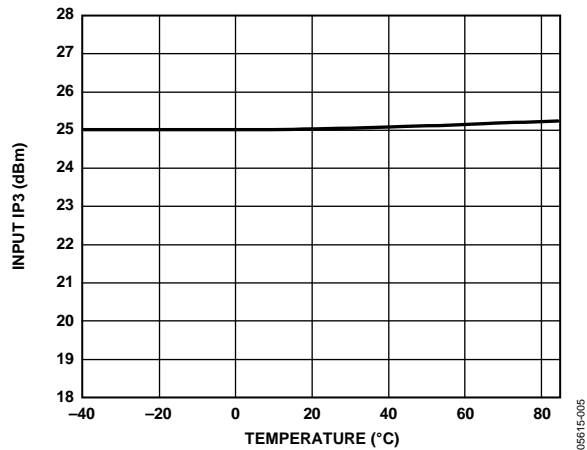

Figure 5. Input IP3 vs. Temperature

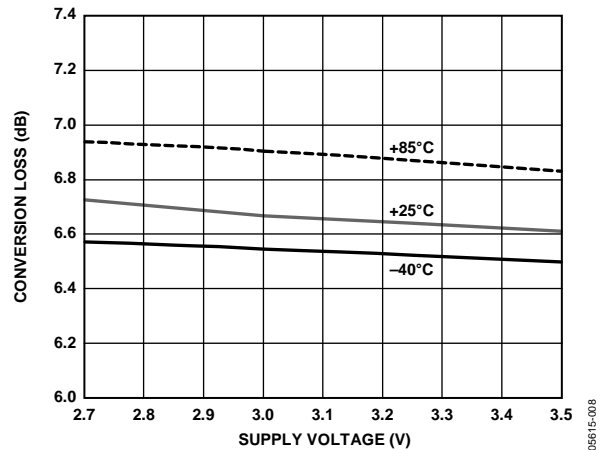

Figure 8. Conversion Loss vs. Supply Voltage

Supply voltage = 3 V, RF frequency = 850 MHz, IF frequency = 70 MHz, RF level = 0 dBm, LO level = 4 dBm, T<sub>A</sub> = 25°C, unless otherwise noted.

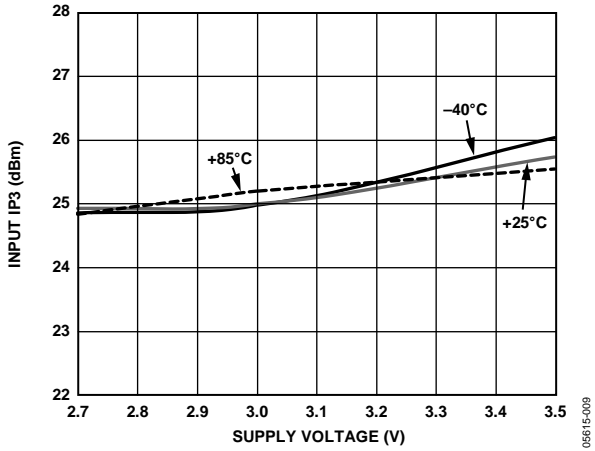

Figure 9. Input IP3 vs. Supply Voltage

05615-009

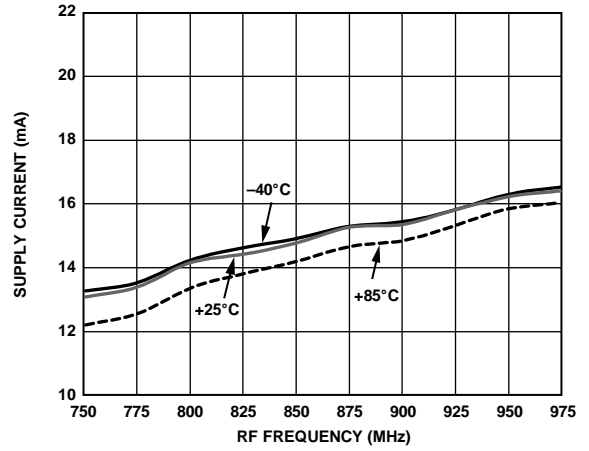

Figure 12. Supply Current vs. RF Frequency

05615-012

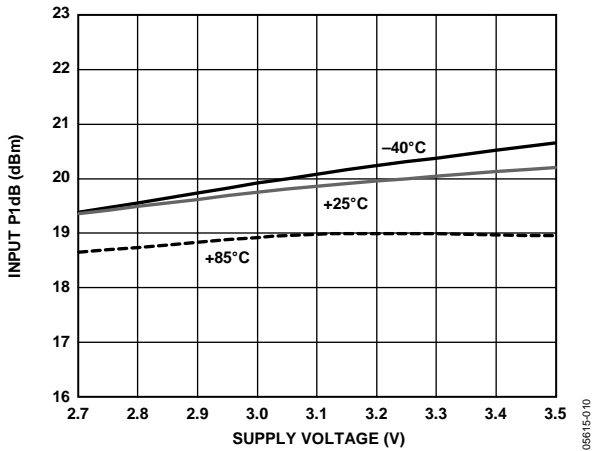

Figure 10. Input P1dB vs. Supply Voltage

05615-010

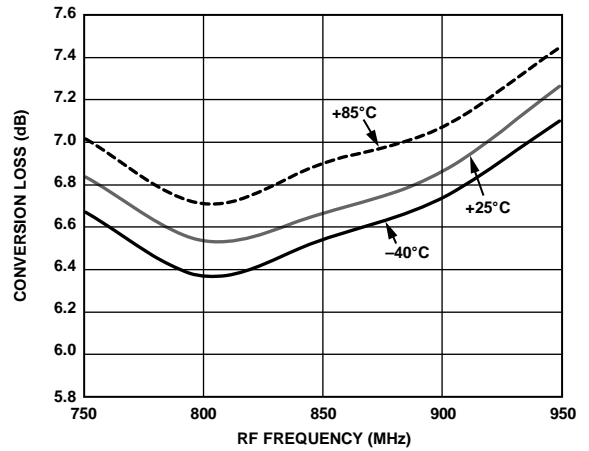

Figure 13. Conversion Loss vs. RF Frequency

05615-013

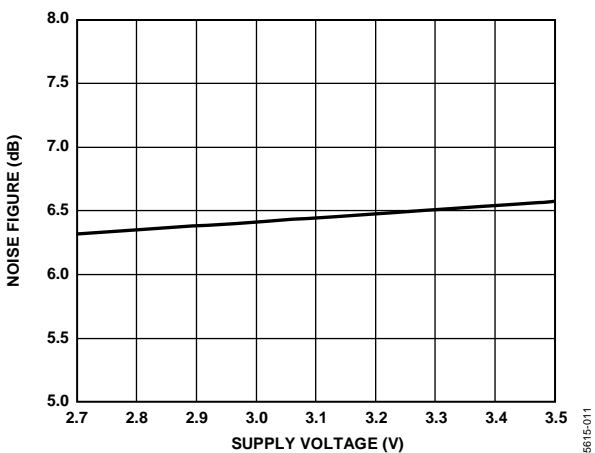

Figure 11. Noise Figure vs. Supply Voltage

05615-011

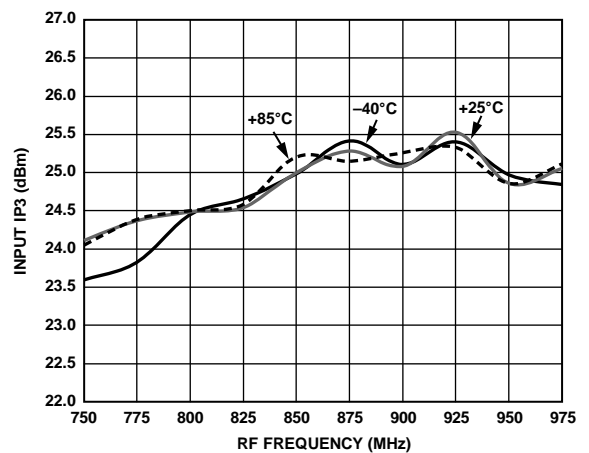

Figure 14. Input IP3 vs. RF Frequency

05615-014



Supply voltage = 3 V, RF frequency = 850 MHz, IF frequency = 70 MHz, RF level = 0 dBm, LO level = 4 dBm, T<sub>A</sub> = 25°C, unless otherwise noted.

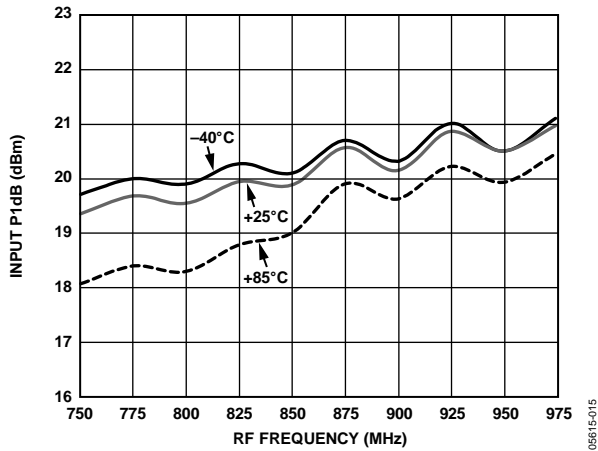

Figure 15. Input P1dB vs. RF Frequency

05615-015

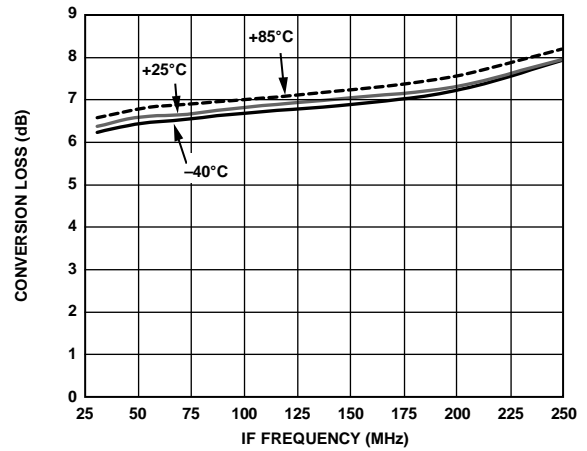

Figure 18. Conversion Loss vs. IF Frequency

05615-018

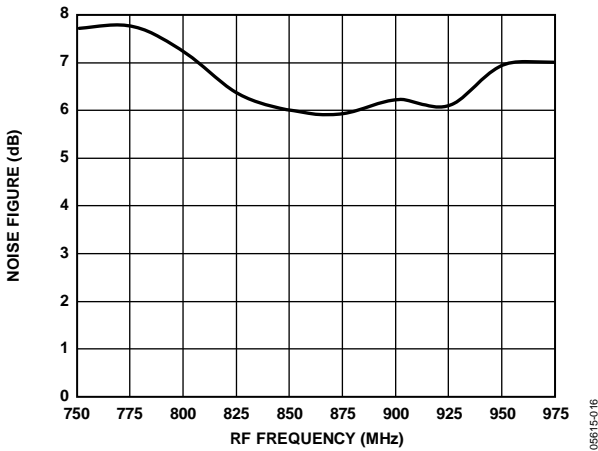

Figure 16. Noise Figure vs. RF Frequency

05615-016

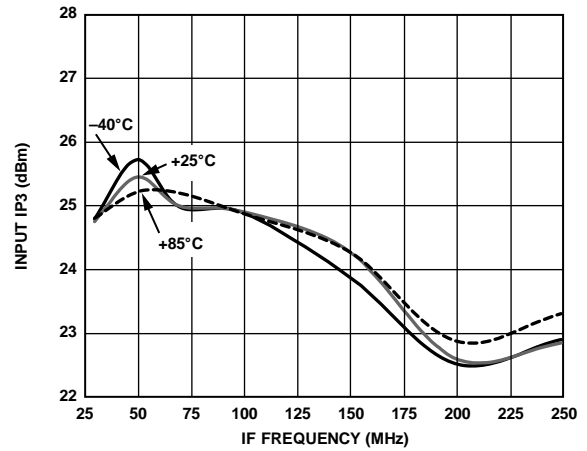

Figure 19. Input IP3 vs. IF Frequency

05615-019

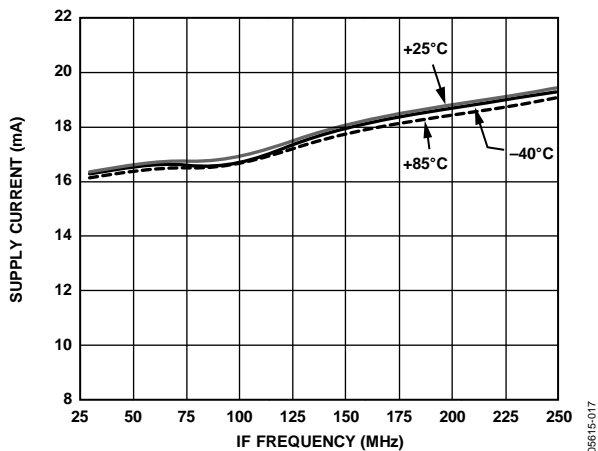

Figure 17. Supply Current vs. IF Frequency

05615-017

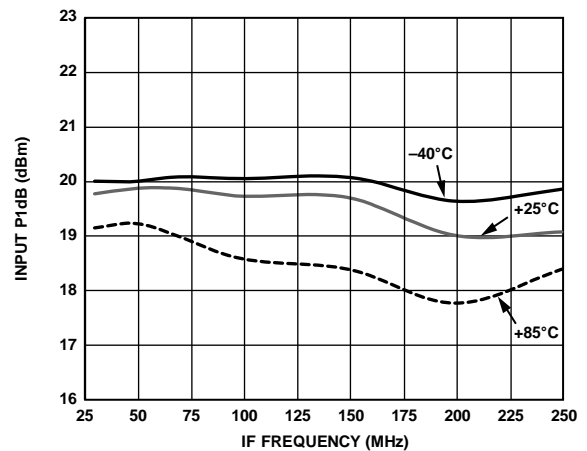

Figure 20. Input P1dB vs. IF Frequency

05615-020

Supply voltage = 3 V, RF frequency = 850 MHz, IF frequency = 70 MHz, RF level = 0 dBm, LO level = 4 dBm,  $T_A = 25^\circ\text{C}$ , unless otherwise noted.

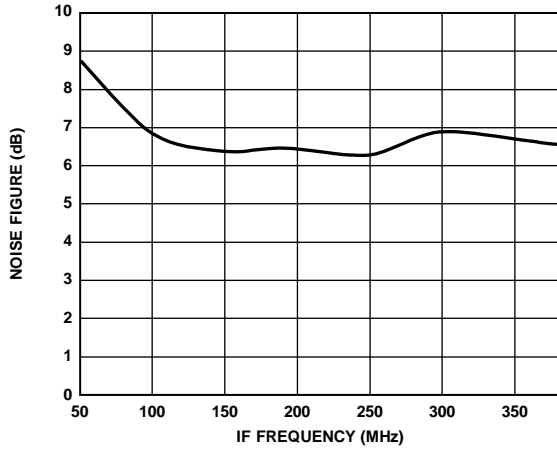

Figure 21. Noise Figure vs. IF Frequency

05615-021

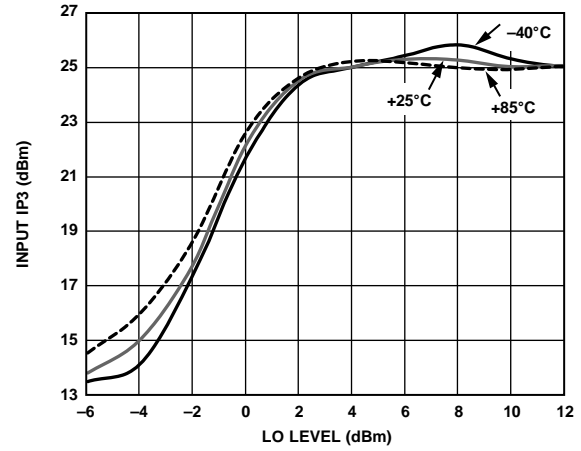

Figure 24. Input IP3 vs. LO Level

05615-024

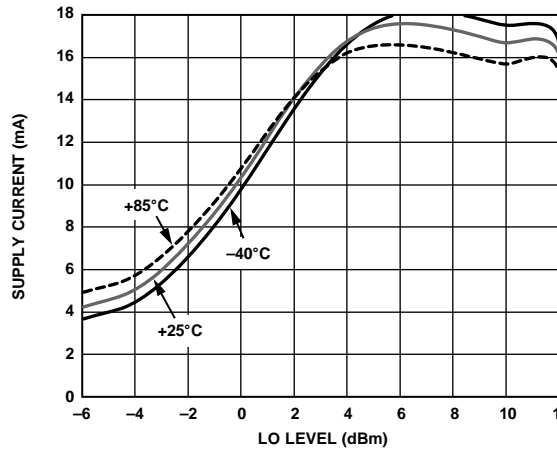

Figure 22. Supply Current vs. LO Level

05615-022

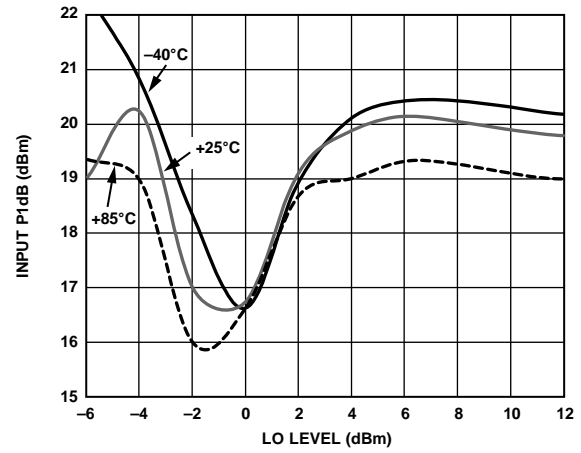

Figure 25. Input P1dB vs. LO Level

05615-025

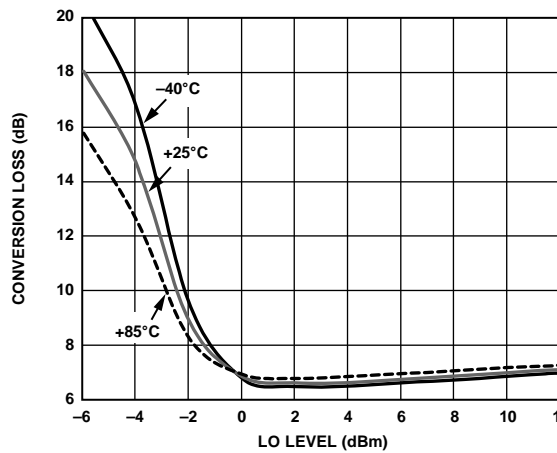

Figure 23. Conversion Loss vs. LO Level

05615-023

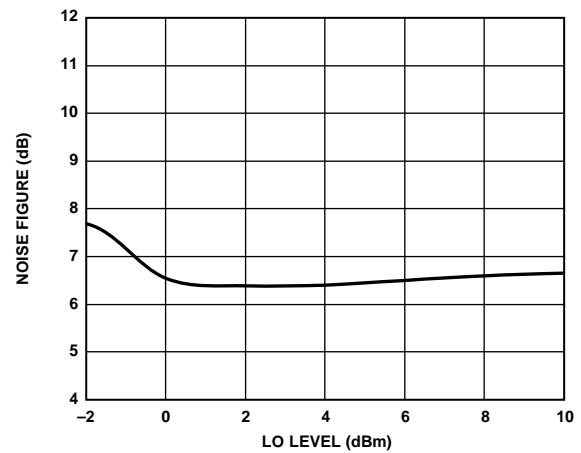

Figure 26. Noise Figure vs. LO Level

05615-026

Supply voltage = 3 V, RF frequency = 850 MHz, IF frequency = 70 MHz, RF level = 0 dBm, LO level = 4 dBm,  $T_A = 25^\circ\text{C}$ , unless otherwise noted.

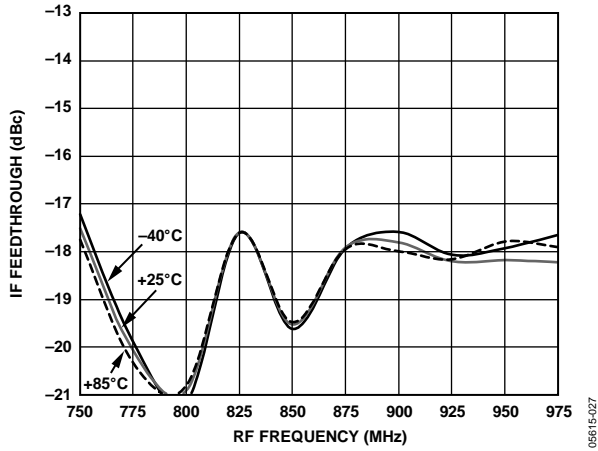

Figure 27. IF Feedthrough vs. RF Frequency

09615-027

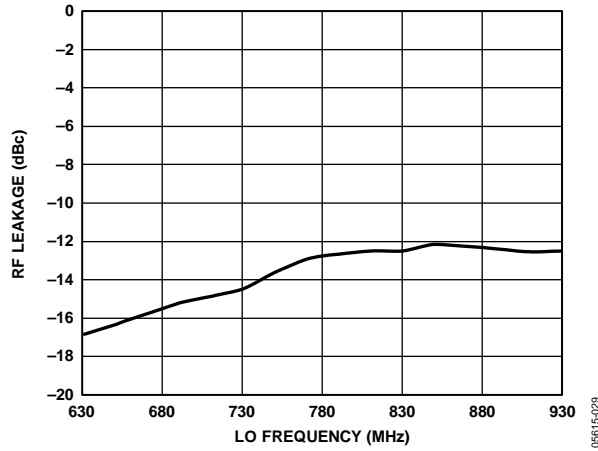

Figure 29. RF Leakage vs. LO Frequency

09615-029

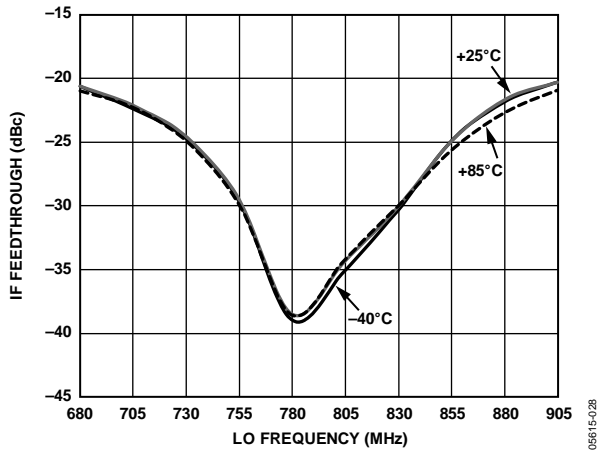

Figure 28. IF Feedthrough vs. LO Frequency

09615-028

1950 MHz CHARACTERISTICS

Supply voltage = 3 V, RF frequency = 1950 MHz, IF frequency = 190 MHz, RF level = -10 dBm, LO level = 6 dBm, T<sub>A</sub> = 25°C, unless otherwise noted.

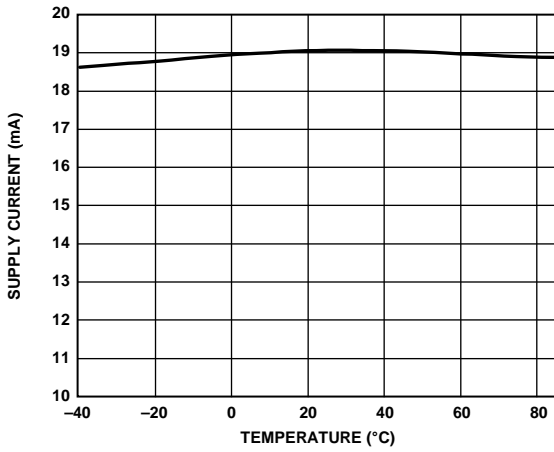

Figure 30. Supply Current vs. Temperature

05615-030

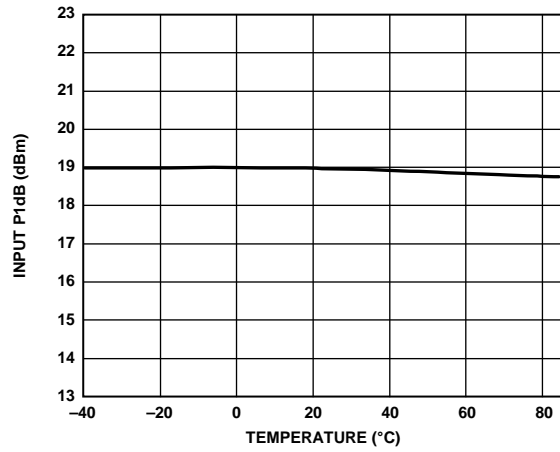

Figure 33. Input P1dB vs. Temperature

05615-033

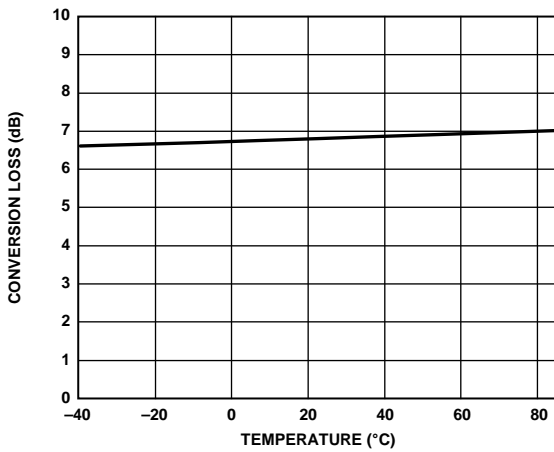

Figure 31. Conversion Loss vs. Temperature

05615-031

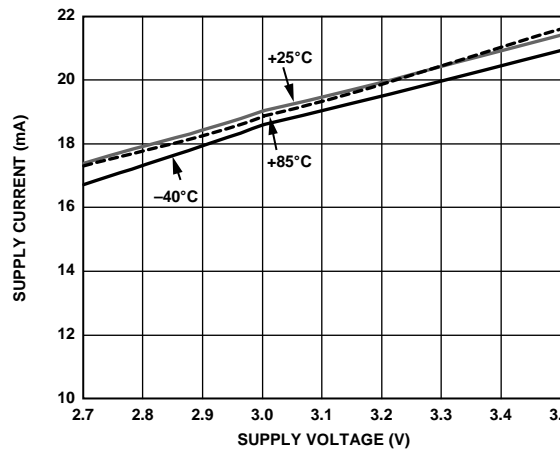

Figure 34. Supply Current vs. Supply Voltage

05615-034

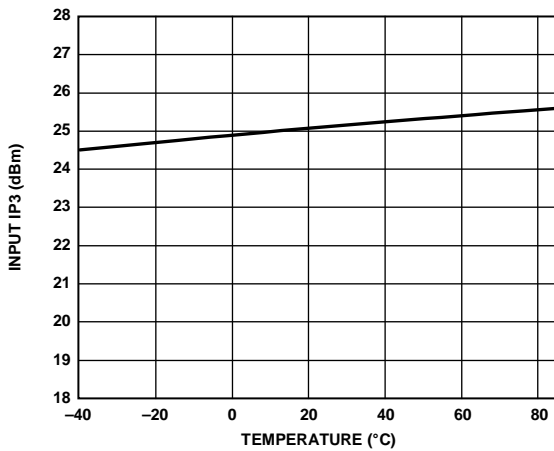

Figure 32. Input IP3 vs. Temperature

05615-032

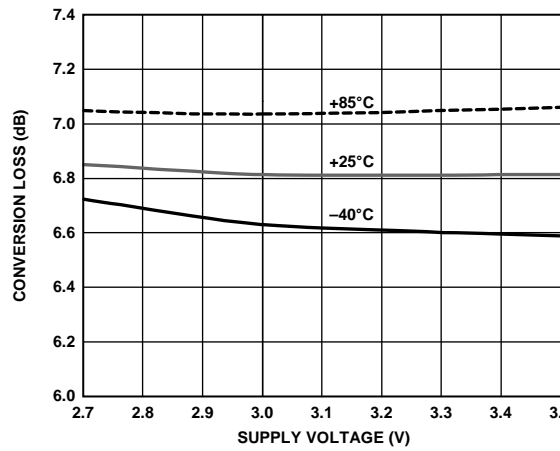

Figure 35. Conversion Loss vs. Supply Voltage

05615-035

Supply voltage = 3 V, RF frequency = 1950 MHz, IF frequency = 190 MHz, RF level = -10 dBm, LO level = 6 dBm,  $T_A = 25^\circ\text{C}$ , unless otherwise noted.

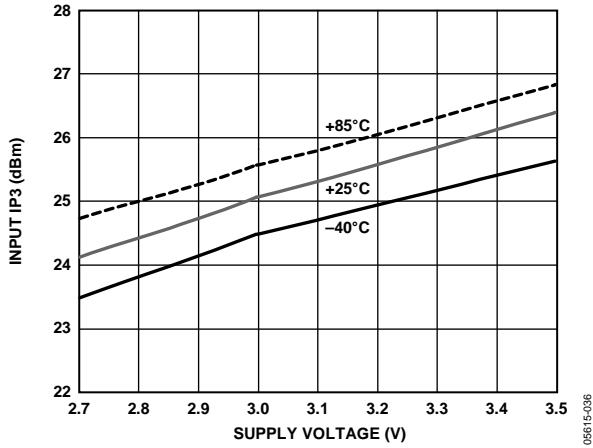

Figure 36. Input IP3 vs. Supply Voltage

05615-006

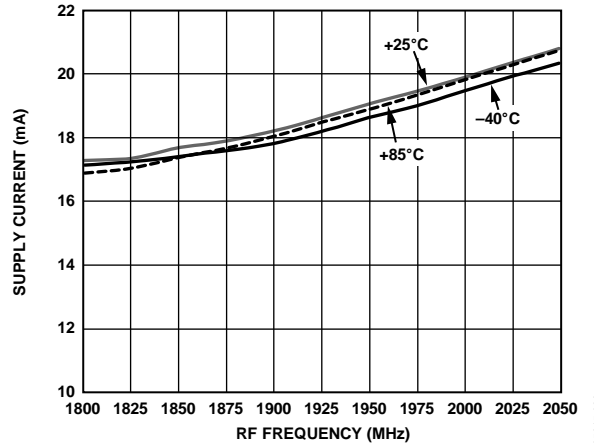

Figure 39. Supply Current vs. RF Frequency

05615-039

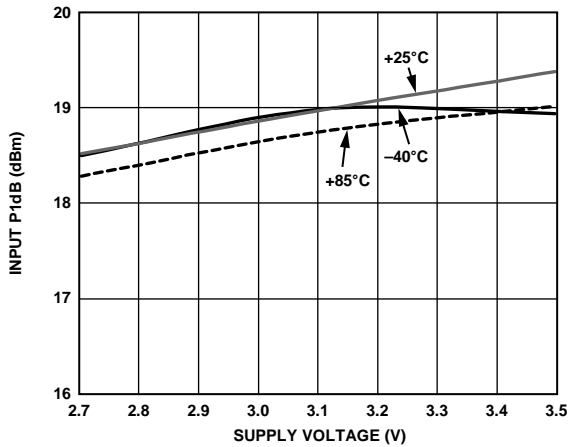

Figure 37. Input P1dB vs. Supply Voltage

05615-037

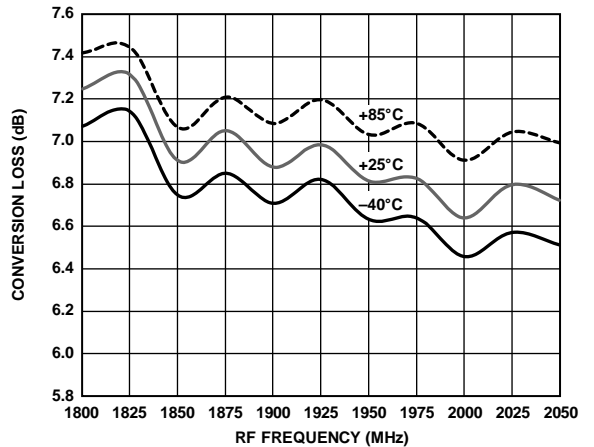

Figure 40. Conversion Loss vs. RF Frequency

05615-040

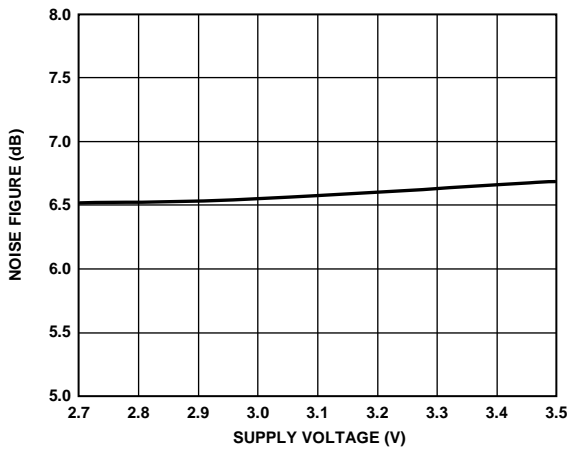

Figure 38. Noise Figure vs. Supply Voltage

05615-038

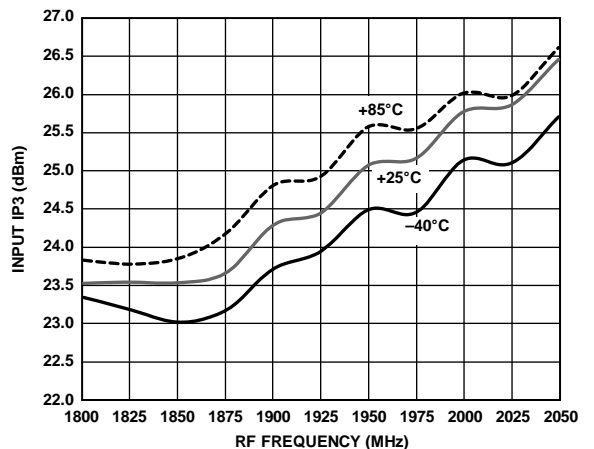

Figure 41. Input IP3 vs. RF Frequency

05615-041

Supply voltage = 3 V, RF frequency = 1950 MHz, IF frequency = 190 MHz, RF level = -10 dBm, LO level = 6 dBm,  $T_A = 25^\circ\text{C}$ , unless otherwise noted.

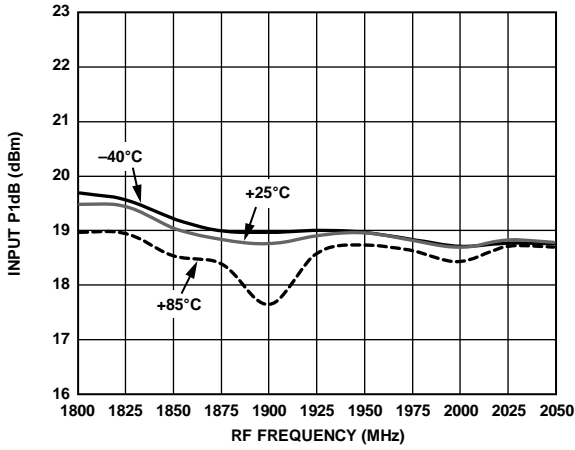

Figure 42. Input P1dB vs. RF Frequency

05615-042

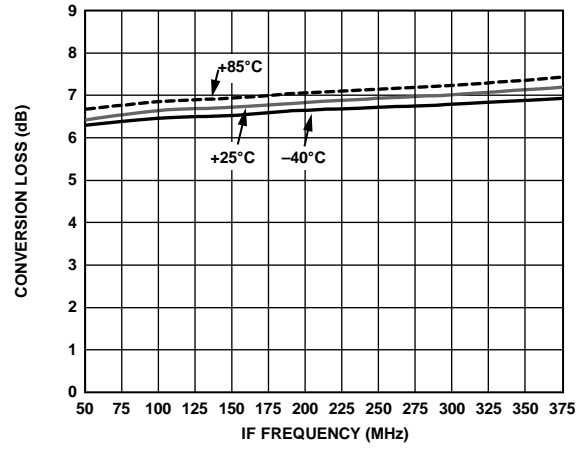

Figure 45. Conversion Loss vs. IF Frequency

05615-045

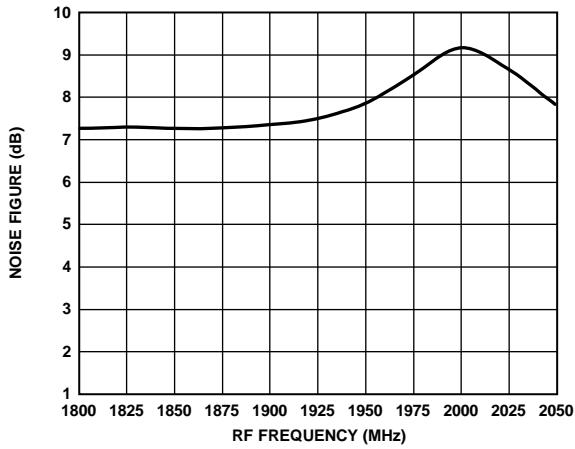

Figure 43. Noise Figure vs. RF Frequency

05615-043

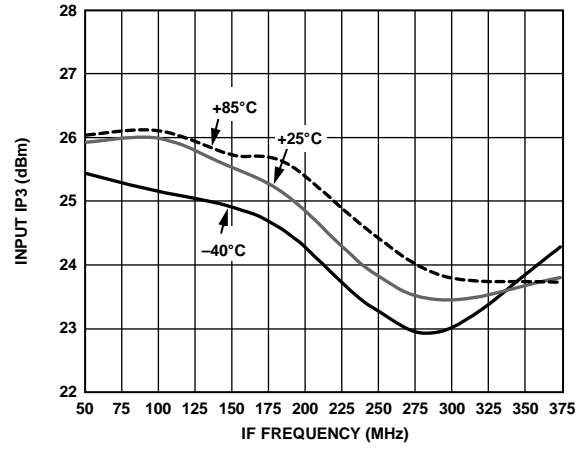

Figure 46. Input IP3 vs. IF Frequency

05615-046

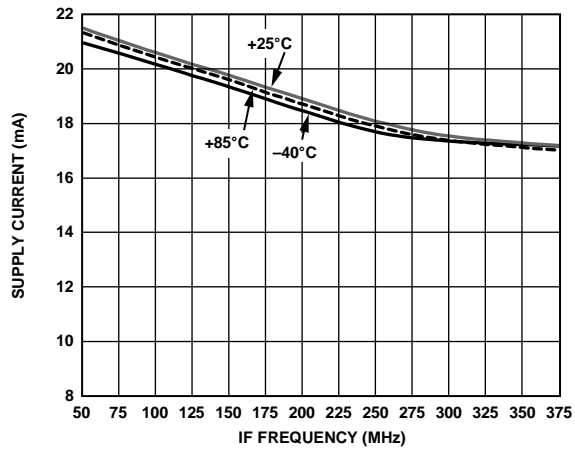

Figure 44. Supply Current vs. IF Frequency

05615-044

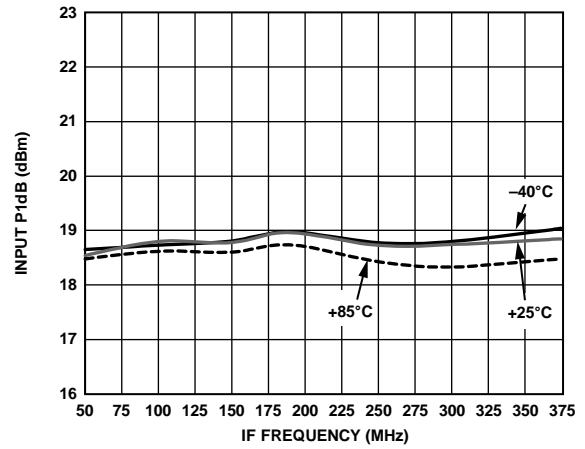

Figure 47. Input P1dB vs. IF Frequency

05615-047

Supply voltage = 3 V, RF frequency = 1950 MHz, IF frequency = 190 MHz, RF level = -10 dBm, LO level = 6 dBm,  $T_A = 25^\circ\text{C}$ , unless otherwise noted.

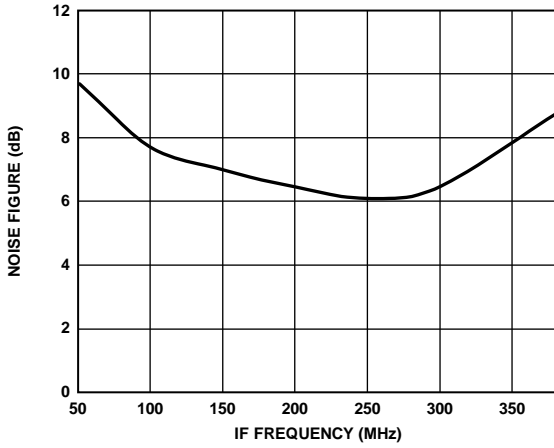

Figure 48. Noise Figure vs. IF Frequency

05615-048

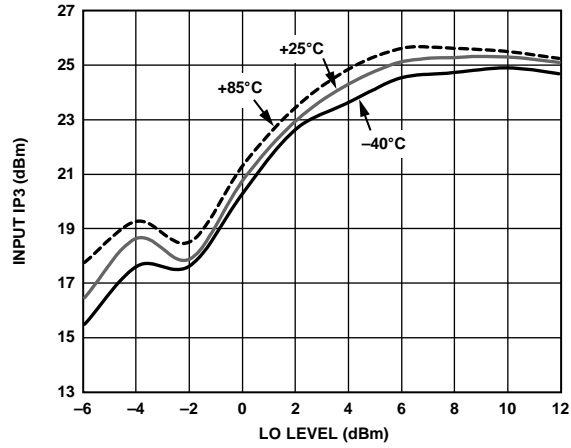

Figure 51. Input IP3 vs. LO Level

05615-051

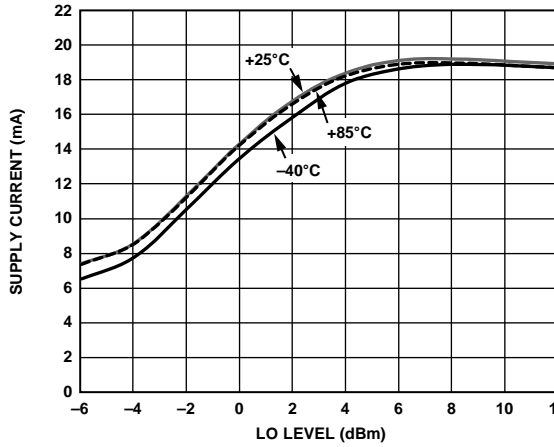

Figure 49. Supply Current vs. LO Level

05615-049

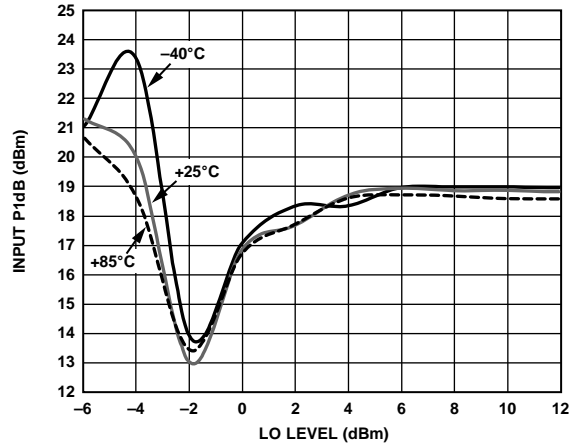

Figure 52. Input P1dB vs. LO Level

05615-052

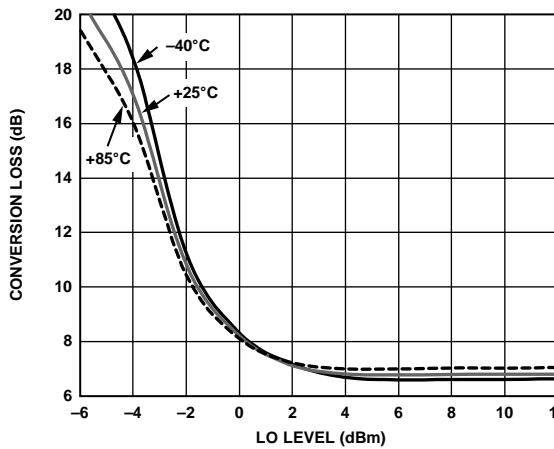

Figure 50. Conversion Loss vs. LO Level

05615-050

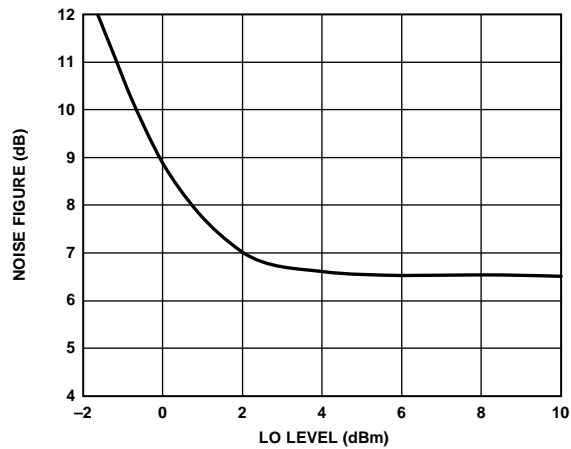

Figure 53. Noise Figure vs. LO Level

05615-053

Supply voltage = 3 V, RF frequency = 1950 MHz, IF frequency = 190 MHz, RF level = -10 dBm, LO level = 6 dBm,  $T_A = 25^\circ\text{C}$ , unless otherwise noted.

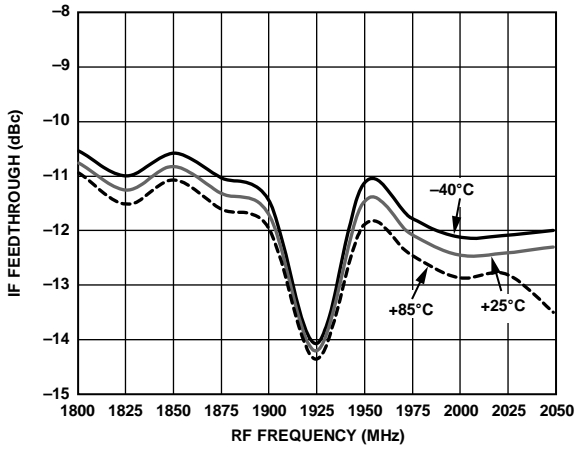

Figure 54. IF Feedthrough vs. RF Frequency

09615-054

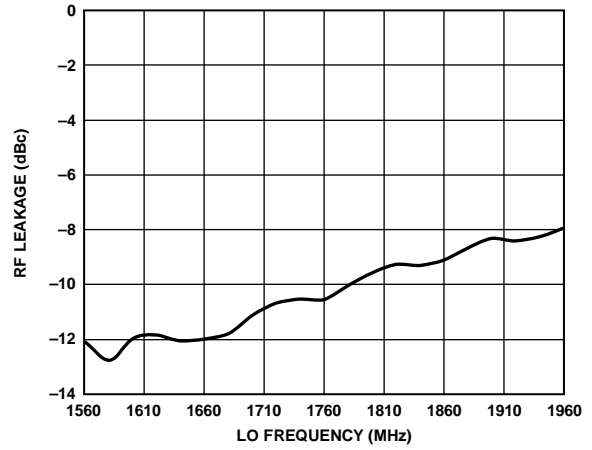

Figure 56. RF Leakage vs. LO Frequency

09615-056

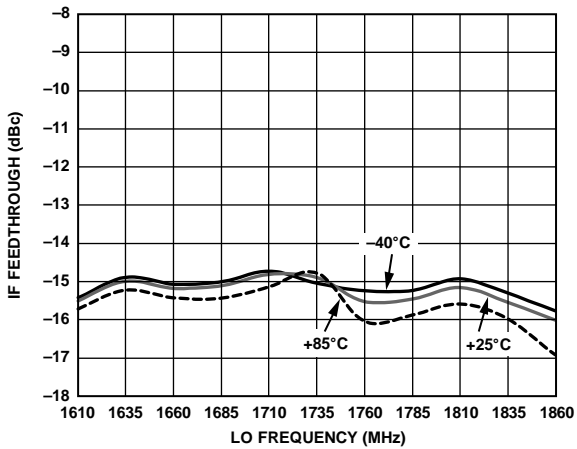

Figure 55. IF Feedthrough vs. LO Frequency

09615-055



# FUNCTIONAL DESCRIPTION

## CIRCUIT DESCRIPTION

The ADL5350 is a GaAs pHEMT, single-ended, passive mixer with an integrated LO buffer amplifier. The device relies on the varying drain to source channel conductance of a FET junction to modulate an RF signal. A simplified schematic is shown in Figure 57.

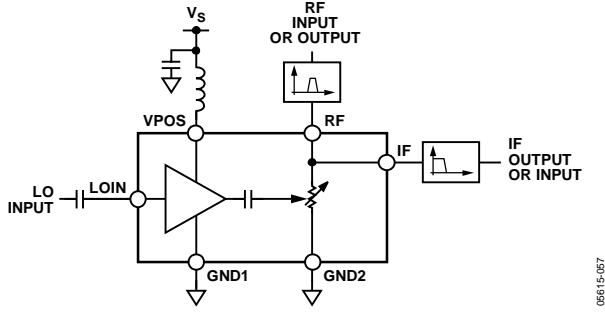

Figure 57. Simplified Schematic

The LO signal is applied to the gate contact of a FET-based buffer amplifier. The buffer amplifier provides sufficient gain of the LO signal to drive the resistive switch. Additionally, feedback circuitry provides the necessary bias to the FET buffer amplifier and RF/IF ports to achieve optimum modulation efficiency for common cellular frequencies.

The mixing of RF and LO signals is achieved by switching the channel conductance from the RF/IF port to ground at the rate of the LO. The RF signal is passed through an external band-pass network to help reject image bands and reduce the broadband noise presented to the mixer. The band-limited RF signal is presented to the time-varying load of the RF/IF port, which causes the envelope of the RF signal to be amplitude modulated at the rate of the LO. A filter network applied to the IF port is necessary to reject the RF signal and pass the wanted mixing product. In a down-conversion application, the IF filter network is designed to pass the difference frequency and present an open circuit to the incident RF frequency. Similarly, for an upconversion application, the filter is designed to pass the sum frequency and reject the incident RF. As a result, the frequency response of the mixer is determined by the response characteristics of the external RF/IF filter networks.

## IMPLEMENTATION PROCEDURE

The ADL5350 is a simple single-ended mixer that relies on off-chip circuitry to achieve effective RF dynamic performance. The following steps should be followed to achieve optimum performance (see Figure 58 for component designations):

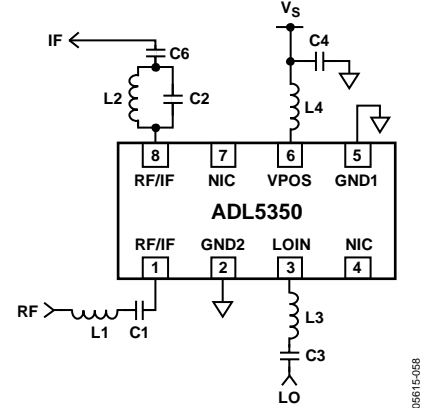

Figure 58. Reference Schematic

- Table 7 shows the recommended LO bias inductor values for a variety of LO frequencies. To ensure efficient commutation of the mixer, the bias inductor needs to be properly set. For other frequencies within the range shown, the values can be interpolated. For frequencies outside this range, see the Applications Information section.

Table 7. Recommended LO Bias Inductor

| Desired LO Frequency (MHz) | Recommended LO Bias Inductor, L4 <sup>1</sup> (nH) |
|----------------------------|--|
| 380                        | 68   |
| 750                        | 24   |
| 1000                       | 18   |
| 1750                       | 3.8  |
| 2000                       | 2.1  |

<sup>1</sup> The bias inductor should have a self-resonant frequency greater than the intended frequency of operation.

2. Tune the LO port input network for optimum return loss. Typically, a band-pass network is used to pass the LO signal to the LOIN pin. It is recommended to block high frequency harmonics of the LO from the mixer core. LO harmonics cause higher RF frequency images to be downconverted to the desired IF frequency and result in sensitivity degradation. If the intended LO source has poor harmonic distortion and spectral purity, it may be necessary to employ a higher order band-pass filter network. Figure 58 illustrates a simple LC band-pass filter used to pass the fundamental frequency of the LO source. Capacitor C3 is a simple dc block, while the Series Inductor L3, along with the gate-to-source capacitance of the buffer amplifier, form a low-pass network. The native gate input of the LO buffer (FET) alone presents a rather high input impedance. The gate bias is generated internally using feedback that can result in a positive return loss at the intended LO frequency.

If a better than  $-10$  dB return loss is desired, it may be necessary to add a shunt resistor to ground before the coupling capacitor (C3) to present a lower loading impedance to the LO source. In doing so, a slightly greater LO drive level may be required.

3. Design the RF and IF filter networks. Figure 58 depicts simple LC tank filter networks for the IF and RF port interfaces. The RF port LC network is designed to pass the RF input signal. The series LC tank has a resonant frequency at  $1/(2\pi\sqrt{LC})$ . At resonance, the series reactances are canceled, which presents a series short to the RF signal. A parallel LC tank is used on the IF port to reject the RF and LO signals. At resonance, the parallel LC tank presents an open circuit.

It is necessary to account for the board parasitics, finite Q, and self-resonant frequencies of the LC components when designing the RF, IF, and LO filter networks. Table 8 provides suggested values for initial prototyping.

**Table 8. Suggested RF, IF, and LO Filter Networks for Low-Side LO Injection**

| RF Frequency (MHz) | L1 (nH) <sup>1</sup> | C1 (pF) | L2 (nH) | C2 (pF) | L3 (nH) | C3 (pF) |
|--------------------|----------------------|---------|---------|---------|---------|---------|
| 450                | 8.3                  | 10      | 10      | 10      | 10      | 100     |
| 850                | 6.8                  | 4.7     | 4.7     | 5.6     | 8.2     | 100     |
| 1950               | 1.7                  | 1.5     | 1.7     | 1.2     | 3.5     | 100     |
| 2400               | 0.67                 | 1       | 1.5     | 0.7     | 3.0     | 100     |

<sup>1</sup> The inductor should have a self-resonant frequency greater than the intended frequency of operation. L1 should be a high Q inductor for optimum NF performance.

# APPLICATIONS INFORMATION

## LOW FREQUENCY APPLICATIONS

The ADL5350 can be used in low frequency applications. The circuit in Figure 59 is designed for an RF of 136 MHz to 176 MHz and an IF of 45 MHz using a high-side LO. The series and parallel resonant circuits are tuned for 154 MHz, which is the geometric mean of the desired RF frequencies. The performance of this circuit is depicted in Figure 60.

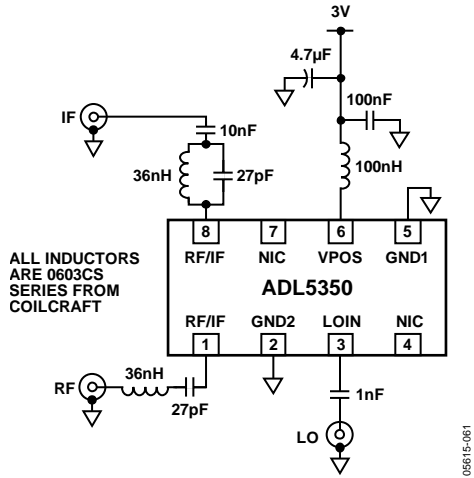

Figure 59. 136 MHz to 176 MHz RF Downconversion Schematic

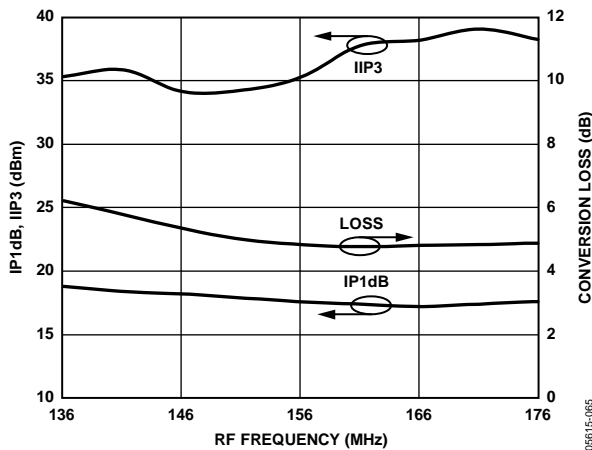

Figure 60. Measured Performance for Circuit in Figure 59 Using High-Side LO Injection and 45 MHz IF

## HIGH FREQUENCY APPLICATIONS

The ADL5350 can be used at extended frequencies with some careful attention to board and component parasitics. Figure 61 is an example of a 2560 MHz to 2660 MHz downconversion using a low-side LO. The performance of this circuit is depicted in Figure 62. Note that the inductor and capacitor values are very small, especially for the RF and IF ports. Above 2.5 GHz, it is necessary to consider alternate solutions to avoid unreasonably small inductor and capacitor values.

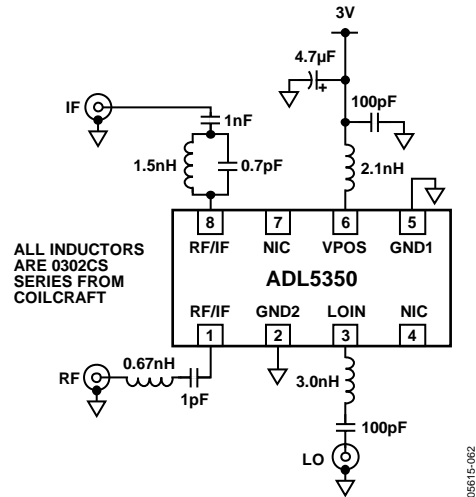

Figure 61. 2560 MHz to 2660 MHz RF Downconversion Schematic

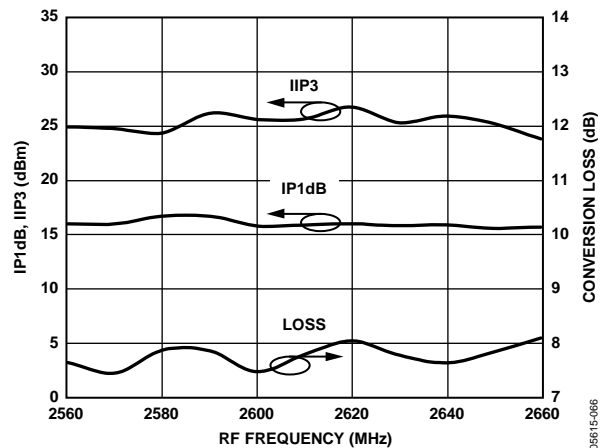

Figure 62. Measured Performance for Circuit in Figure 61 Using Low-Side LO Injection and 374 MHz IF

The typical networks used for cellular applications below 2.6 GHz use band-select and band-reject networks on the RF and IF ports. At higher RF frequencies, these networks are not easily realized by using lumped element components. As a result, it is necessary to consider alternate filter network topologies to allow more reasonable values for inductors and capacitors.

Figure 63 depicts a crossover filter network approach to provide isolation between the RF and IF ports for a downconverting application. The crossover network essentially provides a high-pass filter to allow the RF signal to pass to the RF/IF node (Pin 1 and Pin 8), while presenting a low-pass filter (which is actually a band-pass filter when considering the dc blocking capacitor,  $C_{AC}$ ). This allows the difference component ( $f_{RF} - f_{LO}$ ) to be passed to the desired IF load.

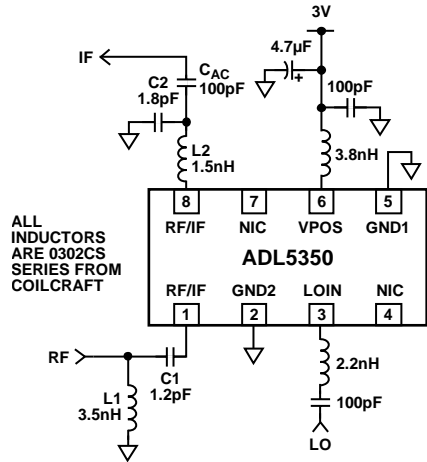

Figure 63. 3.3 GHz to 3.8 GHz RF Downconversion Schematic

When designing the RF port and IF port networks, it is important to remember that the networks share a common node (the RF/IF pins). In addition, the opposing network presents some loading impedance to the target network being designed.

Classic audio crossover filter design techniques can be applied to help derive component values. However, some caution must be applied when selecting component values. At high RF frequencies, the board parasitics can significantly influence the final optimum inductor and capacitor component selections. Some empirical testing may be necessary to optimize the RF and IF port filter networks. The performance of the circuit depicted in Figure 63 is provided in Figure 64.

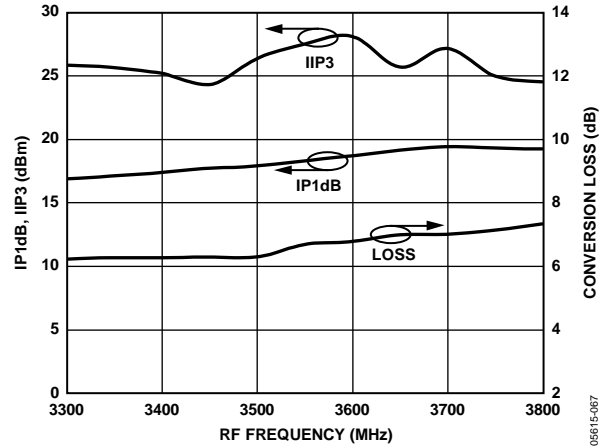

Figure 64. Measured Performance for Circuit in Figure 63 Using Low-Side LO Injection and 800 MHz IF

## EVALUATION BOARD

An evaluation board is available for the [ADL5350](#). The evaluation board has two halves: a low band board designated as Board A and a high band board designated as Board B. The schematic for the evaluation board is shown in Figure 65.

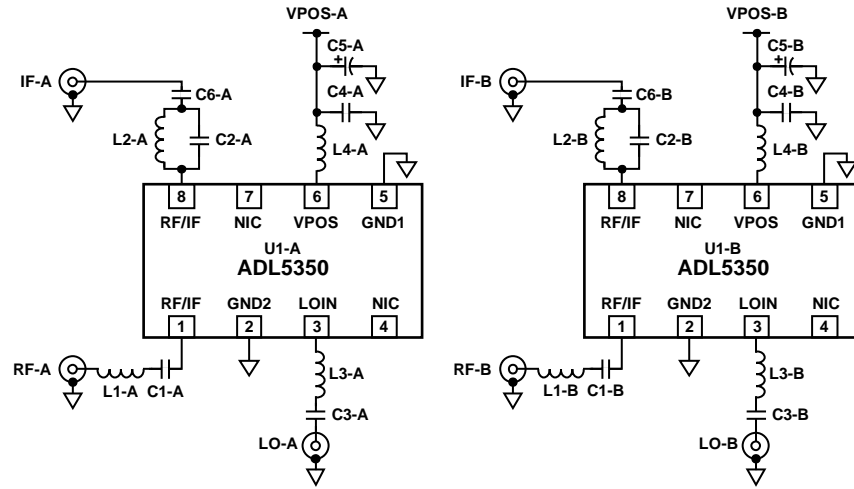

Figure 65. Evaluation Board

Table 9. Evaluation Board Configuration Options

| Component  | Function  | Default Conditions  |
|--|---|---|
| C4-A, C4-B, C5-A, C5-B<br>L1-A, L1-B, C1-A, C1-B | Supply Decoupling. C4-A and C4-B provide local bypassing of the supply. C5-A and C5-B are used to filter the ripple of a noisy supply line. These are not always necessary.<br>RF Input Network. Designed to provide series resonance at the intended RF frequency. | C4-A = C4-B = 100 pF,<br>C5-A = C5-B = 4.7 μF<br>L1-A = 6.8 nH (0603CS from Coilcraft),<br>L1-B = 1.7 nH (0302CS from Coilcraft),<br>C1-A = 4.7 pF, C1-B = 1.5 pF |
| L2-A, L2-B, C2-A, C2-B, C6-A, C6-B               | IF Output Network. Designed to provide parallel resonance at the geometric mean of the RF and LO frequencies.   | L2-A = 4.7 nH (0603CS from Coilcraft),<br>L2-B = 1.7 nH (0302CS from Coilcraft),<br>C2-A = 5.6 pF, C2-B = 1.2 pF,<br>C6-A = C6-B = 1 nF                           |
| L3-A, L3-B, C3-A, C3-B                           | LO Input Network. Designed to block dc and optimize LO voltage swing at LOIN.   | L3-A = 8.2 nH (0603CS from Coilcraft),<br>L3-B = 3.5 nH (0302CS from Coilcraft),<br>C3-A = C3-B = 100 pF  |
| L4-A, L4-B                                       | LO Buffer Amplifier Choke. Provides bias and ac loading impedance to LO buffer amplifier.   | L4-A = 24 nH (0603CS from Coilcraft),<br>L4-B = 3.8 nH (0302CS from Coilcraft)  |

OUTLINE DIMENSIONS

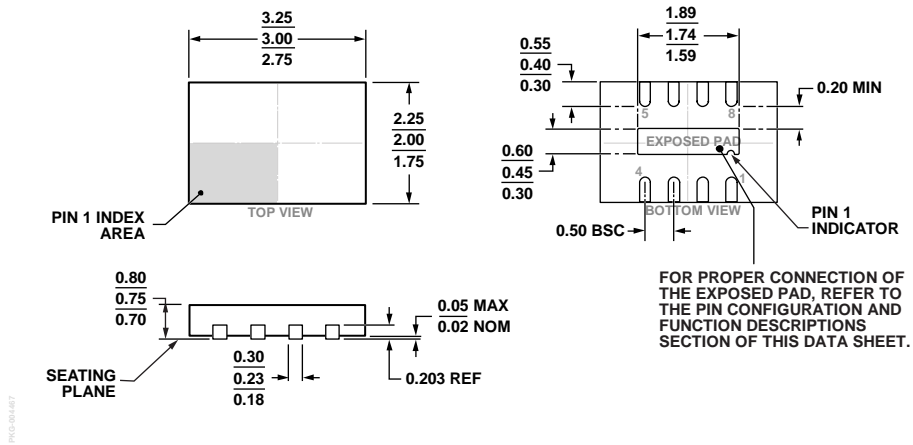

Figure 66. 8-Lead Lead Frame Chip Scale Package [LFCS]  
 2 mm x 3 mm Body and 0.75 mm Package Height  
 (CP-8-23)  
 Dimensions shown in millimeters

ORDERING GUIDE

| Model <sup>1</sup> | Temperature Range | Package Description                         | Package Option | Branding | Ordering Quantity |
|--------------------|-------------------|---|----------------|----------|-------------------|
| ADL5350ACPZ-R2     | -40°C to +85°C    | 8-Lead Lead Frame Chip Scale Package [LFCS] | CP-8-23        | 08       | 240, Reel         |
| ADL5350ACPZ-R7     | -40°C to +85°C    | 8-Lead Lead Frame Chip Scale Package [LFCS] | CP-8-23        | 08       | 3000, Reel        |
| ADL5350ACPZ-WP     | -40°C to +85°C    | 8-Lead Lead Frame Chip Scale Package [LFCS] | CP-8-23        | 08       | 50, Waffle Pack   |
| ADL5350-EVALZ      |                   | Evaluation Board                            |                |          |                   |

<sup>1</sup> Z = RoHS Compliant Part.

**NOTES**

**NOTES**



Компания «Океан Электроники» предлагает заключение долгосрочных отношений при поставках импортных электронных компонентов на взаимовыгодных условиях!

Наши преимущества:

- Поставка оригинальных импортных электронных компонентов напрямую с производств Америки, Европы и Азии, а так же с крупнейших складов мира;
- Широкая линейка поставок активных и пассивных импортных электронных компонентов (более 30 млн. наименований);
- Поставка сложных, дефицитных, либо снятых с производства позиций;
- Оперативные сроки поставки под заказ (от 5 рабочих дней);
- Экспресс доставка в любую точку России;
- Помощь Конструкторского Отдела и консультации квалифицированных инженеров;
- Техническая поддержка проекта, помощь в подборе аналогов, поставка прототипов;
- Поставка электронных компонентов под контролем ВП;
- Система менеджмента качества сертифицирована по Международному стандарту ISO 9001;
- При необходимости вся продукция военного и аэрокосмического назначения проходит испытания и сертификацию в лаборатории (по согласованию с заказчиком);
- Поставка специализированных компонентов военного и аэрокосмического уровня качества (Xilinx, Altera, Analog Devices, Intersil, Interpoint, Microsemi, Actel, Aeroflex, Peregrine, VPT, Syfer, Eurofarad, Texas Instruments, MS Kennedy, Miteq, Cobham, E2V, MA-COM, Hittite, Mini-Circuits, General Dynamics и др.);

Компания «Океан Электроники» является официальным дистрибьютором и эксклюзивным представителем в России одного из крупнейших производителей разъемов военного и аэрокосмического назначения «JONHON», а так же официальным дистрибьютором и эксклюзивным представителем в России производителя высокотехнологичных и надежных решений для передачи СВЧ сигналов «FORSTAR».



## JONHON

«JONHON» (основан в 1970 г.)

Разъемы специального, военного и аэрокосмического назначения:

(Применяются в военной, авиационной, аэрокосмической, морской, железнодорожной, горно- и нефтедобывающей отраслях промышленности)

«FORSTAR» (основан в 1998 г.)

ВЧ соединители, коаксиальные кабели, кабельные сборки и микроволновые компоненты:

(Применяются в телекоммуникациях гражданского и специального назначения, в средствах связи, РЛС, а так же военной, авиационной и аэрокосмической отраслях промышленности).



Телефон: 8 (812) 309-75-97 (многоканальный)

Факс: 8 (812) 320-03-32

Электронная почта: [ocean@oceanchips.ru](mailto:ocean@oceanchips.ru)

Web: <http://oceanchips.ru/>

Адрес: 198099, г. Санкт-Петербург, ул. Калинина, д. 2, корп. 4, лит. А