



Title	<i>Reference Design Report for a 1.2 W Non-Isolated, Dual Output Buck / Buck-Derived Power Supply with Configurable Positive or Negative Outputs Using LNK304DN</i>
Specification	85 – 265 VAC Input, 12 V, 80 mA and 5 V, 50 mA Outputs
Application	Meters
Author	Power Integrations Applications Department
Document Number	RDR-138
Date	November 12, 2007
Revision	1.0

Summary and Features

- Compact, lightweight, low cost, low component count design provides two outputs
- Outputs configurable as both positive or one positive and one negative
- Very good cross regulation
- Integrated safety and reliability features
 - Accurate, auto-recovering, thermal shutdown function maintains safe PCB temperatures under all conditions
 - Auto-restart protects against output short circuits and lost regulation faults
- Meets CISPR-22/EN55022B limits for conducted EMI with >10 dB margin

The products and applications illustrated herein (including circuits external to the products and transformer construction) may be covered by one or more U.S. and foreign patents or potentially by pending U.S. and foreign patent applications assigned to Power Integrations. A complete list of Power Integrations' patents may be found at www.powerint.com.

Table of Contents

1	Introduction.....	3
2	Power Supply Specification	4
3	Schematic.....	5
4	Circuit Description	6
4.1	AC Input Rectification and EMI Filtering	6
4.2	LinkSwitch-TN Device	6
4.3	Output Rectification and Filtering	7
4.4	Feedback Network	7
4.5	Linear Regulator.....	8
5	PCB Layout	9
6	Bill of Materials	10
7	Performance Data	11
7.1	Efficiency.....	11
7.1.1	Active Mode CEC Measurement Data.....	11
7.2	No-load Input Power.....	13
7.3	Regulation	13
7.3.1	Load and Line	13
7.3.2	Line	15
8	Thermal Performance.....	16
9	Waveforms	17
9.1	Drain Voltage and Current, Normal Operation.....	17
9.2	Output Voltage Start-up Profile.....	17
9.3	Source Voltage and Drain Current Start-up Profile.....	18
9.4	Load Transient Response (75% to 100% Load Step)	19
9.5	Output Ripple Measurements.....	21
9.5.1	Ripple Measurement Technique	21
9.5.2	Measurement Results	22
10	Conducted EMI	23
11	Line Surge.....	24
12	Revision History	25

Important Note:

Although this board is designed to satisfy safety isolation requirements, the engineering prototype has not been agency approved. Therefore, all testing should be performed using an isolation transformer to provide the AC input to the prototype board.



1 Introduction

This document is an engineering report describing both a buck and a buck-derived power supply utilizing a LNK304DN device that provides two output voltages.

The document contains the power supply specification, schematic, bill of materials, transformer documentation, printed circuit layout, and performance data.



Figure 1 – Populated Circuit Board Photograph.

2 Power Supply Specification

Description	Symbol	Min	Typ	Max	Units	Comment
Input						
Voltage	V_{IN}	85		265	VAC	2 Wire – no P.E.
Frequency	f_{LINE}	47	50/60	64	Hz	
No-load Input Power (230 VAC)				0.2	W	
Output						
Output Voltage 1	V_{OUT1}		12		V	± 5% 20 MHz Bandwidth
Output Ripple Voltage 1	$V_{RIPPLE1}$				mV	
Output Current 1	I_{OUT1}		80		mA	± 5% 20 MHz Bandwidth
Output Voltage 2	V_{OUT2}		5		V	
Output Ripple Voltage 2	$V_{RIPPLE1}$				mV	
Output Current 2	I_{OUT1}		50		mA	
Total Output Power						
Continuous Output Power	P_{OUT}			1.21	W	
Efficiency						
Full Load	η	52.7			%	Measured at P_{OUT} 25 °C
Required average efficiency at 25, 50, 75 and 100 % of P_{OUT}	η_{CEC}^1	51.7			%	Per California Energy Commission (CEC) / Energy Star Requirements
Environmental						
Conducted EMI		Meets CISPR22B / EN55022B				1.2/50 μ s Surge, IEC 61000-4-5, Series Impedance: Differential Mode: 2 Ω
Safety		Designed to meet IEC950, UL1950 Class II				
Surge		1			kV	
Differential Mode						
Ambient Temperature	T_{AMB}	0		50	°C	Free Convection, Sea Level

¹ CEC does not apply to this design but data are shown for reference.



3 Schematic

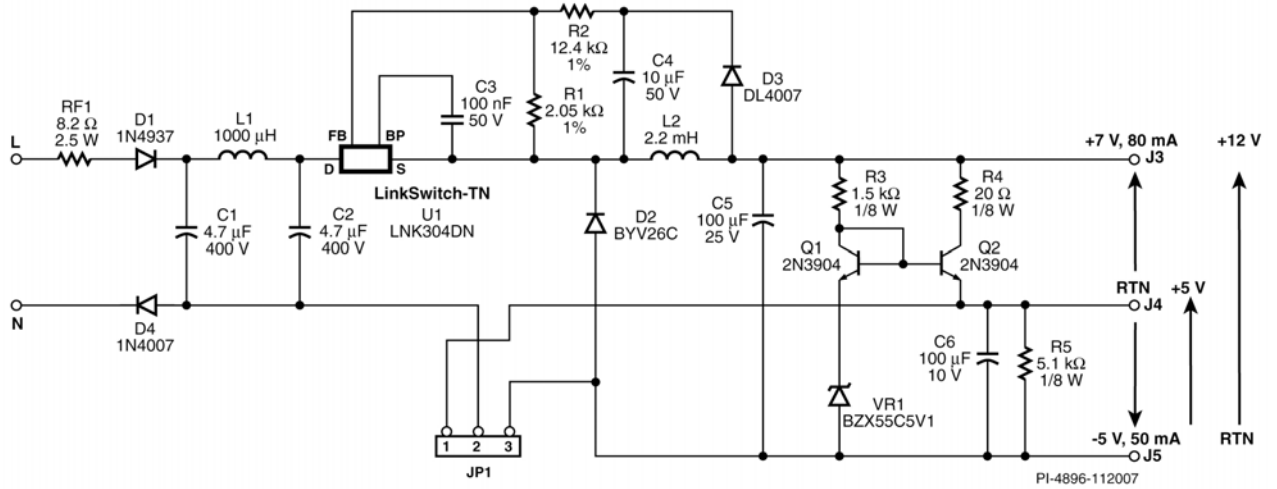

Figure 2 – Schematic.

With respect to RTN (J4), the supply provides outputs of – 5 V & +7 V with pins 1 & 2 of JP1 shorted. When pins 2 & 3 of JP1 are shorted, the supply provides +5 V and +12 V with respect to RTN (J5).



4 Circuit Description

The power supply described has a jumper that allows for the supply to operate using either the buck topology—enabling the two outputs to be configured as positive outputs with respect to AC neutral—or a buck-derived topology—enabling one of the two outputs to be configured as a negative output with respect to AC neutral. Shorting pins 1 and 2 of JP1 will operate the supply in a buck-derived topology, while shorting pins 2 and 3 will operate the supply in the buck topology. See Figure 1 for an illustration of the two jumper positions.

While in the buck topology, the power supply has a 12 V output capable of delivering 80 mA and a 5 V output capable of 50 mA. If the supply is in the buck-derived topology, it provides a –5 V output when referenced to return and can provide 50 mA of current. The other output can be used to supply 80 mA and a 7 V output when referenced to return, or it can be configured as a floating 12 V output.

The data presented in the report were taken using the buck topology with both outputs configured as positive outputs.

4.1 AC Input Rectification and EMI Filtering

The AC input is half-wave rectified by fast recovery diode D1 and general purpose diode D4. The fast recovery diode helps to improve differential mode conducted EMI. A second diode, D4, is placed in the return conductor of the supply to provide EMI noise gating. This helps minimize common mode noise and reduce EMI.

Included in the path of the AC input is a fusible flameproof resistor, RF1. In the event of a catastrophic failure, the failure mechanism of this resistor is open circuit, with no flame or smoke emitted. Additionally, this resistor is wire wound to prevent premature failure due to the inrush currents when AC is applied.

The input stage is completed by capacitors C1 and C2, which provide bulk energy storage. Inductor L1 forms a π -filter with the bulk capacitors, which helps to minimize differential mode conducted EMI.

4.2 LinkSwitch-TN Device

LinkSwitch-TN is a low-cost, full-featured monolithic IC integrating both the control circuitry and high voltage MOSFET switch into the same device. Some of the most prominent features of the device include an On/Off type controller, a maximum switching frequency of 66 kHz, which includes ± 4 kHz of frequency jitter to help reduce EMI and a 700 V MOSFET. The LinkSwitch-TN device also includes a number of protection features, including output short-circuit protection, open loop fault protection, MOSFET current limit protection and thermal shutdown with hysteresis. The device is powered from the drain pin with local supply decoupling provided by the 100 nF capacitor C3 connected to the bypass pin (BP) of the LinkSwitch-TN device, U1.



4.3 Output Rectification and Filtering

During U1's conduction time, current through inductor L2 linearly ramps up, delivering energy to the load and to capacitor C5. During U1's on time, the energy from the inductor is also used by the linear regulator circuitry.

During U1's off time, the voltage across inductor L2 changes its polarity in an attempt to maintain current flow and thus forward biases freewheeling diode D2. During D2's conduction time, the energy stored in the inductor is delivered to capacitor C5, the load, and the linear regulator while the current through the inductor ramps downward.

Freewheeling diode D2 provides output rectification and should be an ultrafast type diode, such as UF4005 with a reverse recovery time $t_{rr} \leq 75$ ns (In this case the BYV26C was used to improve efficiency). This is a sufficient reverse recovery time as this design operates in the mostly discontinuous operating mode (MDCM). Slower diodes result in large leading edge current spikes, which will result in prematurely terminated switching cycles due to exceeding the device's internal current limit. This diode should also be able to withstand the maximum DC bus voltage plus an appropriate margin (usually at least 25%).

4.4 Feedback Network

As previously mentioned, the LinkSwitch-TN family of devices uses a simple and efficient On/Off control scheme. The on time of the MOSFET is determined by the output inductor's value, the current limit of the device and the value of the DC bus voltage. This is due to the use of the On/Off control scheme, which turns off the device once the current limit is reached.

The device will therefore reach its internal current limit during every enabled switching cycle. Thus the output voltage is regulated by disabling (skipping) switching cycles. Switching cycles are skipped whenever current in excess of 49 μ A is delivered into the feedback (FB) pin.

A feedback signal is derived from the output (the voltage across C5) through a simple voltage divider formed by 1 % tolerance metal film resistors R1 and R2. The input signal to this voltage divider is the voltage on capacitor C4, which closely tracks the output voltage and is charged whenever diode D3 is forward biased.

Diode D3 is necessary to prevent the FB pin from delivering current to the output whenever the MOSFET is conducting, since the FB pin has a voltage of 1.65 V + V_{SOURCE} . The voltage divider does not need to take into account D3's forward voltage drop because, to a first order, D2 and D3's forward voltages are equal, and thus the feedback network tracks the output voltage.



4.5 Linear Regulator

LinkSwitch-TN regulates the voltage across C5 (J5 to J3) to be 12 V. To create a second regulated output, a linear regulator was used.

The linear regulator acts to keep the voltage at J4 centered such that the voltage from J4 to J5 is 6.9 V (12 V - 5.1 V), and -5.1 V from J4 to J5.

Zener diode VR1 defines the voltage on the emitter of Q2 (via Q1), and therefore J4, to be 5.1 V above the voltage on J5. Should this difference in voltage across J4 and J5 reduce, then the voltage on the base of Q2 rises, increasing collector and load current delivered to the -7 V output (J4 to J5) and maintaining the voltage difference.

Maximum dissipation within the linear regulator occurs when the +5 V (J4 to J5) is fully loaded. At full load of 50 mA, this dissipation can be estimated as

$$P_{DQ2} = V_{CEQ2} \times I_{CQ2}$$

$$P_{DQ2} = 5.9 \text{ V} \times 50 \text{ mA} = 295 \text{ mW}$$

Resistor R3 sets the bias current through VR1 to be ~ 4 mA, which also acts as a pre-load for the 12 V output (J5 to J3). For better efficiency and lower no-load consumption, a low test current Zener diode should be used.

An optional pre-load resistor, R5, is placed on the output to maintain better than ±5% voltage regulation on this output. As the transistors Q1 and Q2 are physically close to one another, they provide better thermal tracking by cancelling V_{BE} variations, thereby helping to maintain good regulation.



5 PCB Layout

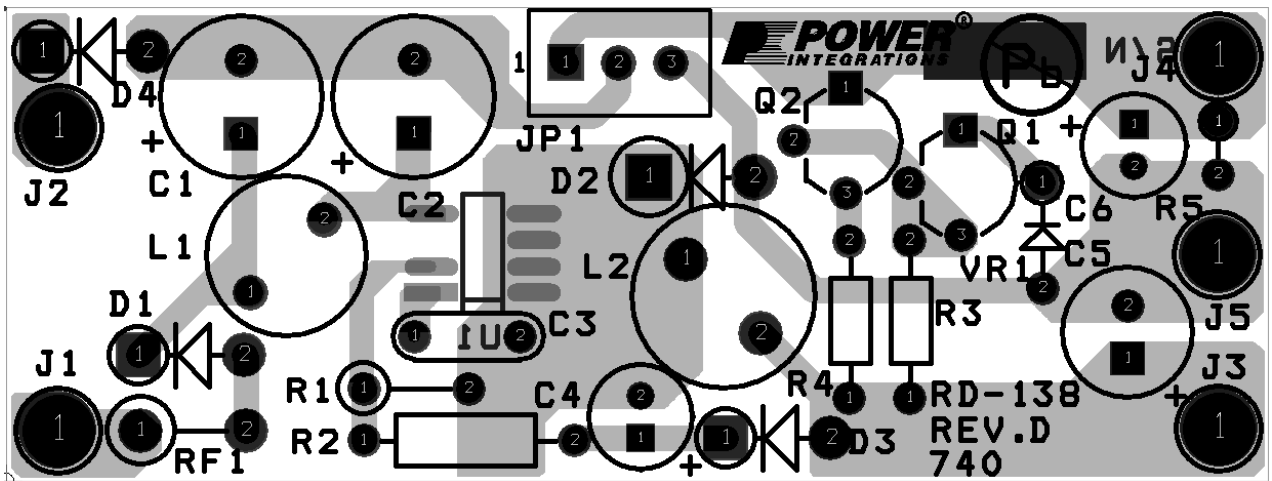

Figure 3 – Printed Circuit Layout.



6 Bill of Materials

Item	Qty	Ref	Description	Mfg	Mfg Part Number
1	2	C1 C2	4.7 μ F, 400 V, Electrolytic, (8 x 11.5)	Taicon Corporation	TAQ2G4R7MK0811MLL3
2	1	C3	100 nF, 50 V, Ceramic, Z5U, .2 Lead Space	Kemet	C317C104M5U5TA
3	1	C4	10 μ F, 50 V, Electrolytic, Gen. Purpose, (5 x 11)	Nippon Chemi-Con	EKMG500ELL100ME11D
4	1	C5	100 μ F, 25 V, Electrolytic, Very Low ESR, 130 m Ω , (6.3 x 11)	Nippon Chemi-Con	EKZE250ELL101MF11D
5	1	C6	100 μ F, 10 V, Electrolytic, Very Low ESR, 300 m Ω , (5 x 11)	Nippon Chemi-Con	EKZE100ELL101ME11D
6	1	D1	600 V, 1 A, Fast Recovery Diode, 200 ns, DO-41	Diodes Inc.	1N4937-T
7	1	D2	600 V, 1 A, Ultrafast Recovery, 30 ns, SOD57	Philips	BYV26C
8	2	D3 D4	1000 V, 1 A, Rectifier, DO-41	Vishay	1N4007-E3/54
9	1	J1	Test Point, WHT, THRU-HOLE MOUNT	Keystone	5012
10	2	J2 J5	Test Point, BLK, THRU-HOLE MOUNT	Keystone	5011
11	1	J3	Test Point, RED, THRU-HOLE MOUNT	Keystone	5010
12	1	J4	Test Point, YEL, THRU-HOLE MOUNT	Keystone	5014
13	1	J6	SHUNT, 2 Position, ECON, PHBR 15 AU, BLACK	Amp/Tyco Elect.	382811-6
14	1	JP1	3 Position (1 x 3) header, 0.1 pitch, Vertical	Molex	22-28-4030
15	1	L1	1000 μ H, 0.28 A	Tokin	SBC3-102-281
16	1	L2	2.2 mH, 0.27 A	Coilcraft	RFB0810-222L
17	2	Q1 Q2	NPN, Small Signal BJT, 40 V, 0.2 A, TO-92	Micro Commercial Components	2N3904-AP
18	1	R1	2.05 k, 1%, 1/4 W, Metal Film	Yageo	MFR-25FBB-2K05
19	1	R2	12.4 k, 1%, 1/4 W, Metal Film	Yageo	MFR-25FBB-12K4
20	1	R3	1.5 k, 5%, 1/8 W, Carbon Film	Yageo	CFR-12JB-1K5
21	1	R4	20 R, 5%, 1/8 W, Carbon Film	Yageo	CFR-12JB-20R
22	1	R5	5.1 k, 5%, 1/8 W, Carbon Film	Yageo	CFR-12JB-5K1
23	1	RF1	8.2 R, 2.5 W, Fusible/Flame Proof Wire Wound	Vitrohm	CRF253-4 5T 8R2
24	1	U1	LinkSwitch-TN, LNK304DN, SO-8	Power Integrations	LNK304DN
25	1	VR1	5.1 V, 500 mW, 5%, DO-35	Vishay	BZX55C5V1

All Parts shown are RoHS compliant



7 Performance Data

All measurements performed at room temperature, 60 Hz input frequency.

7.1 Efficiency

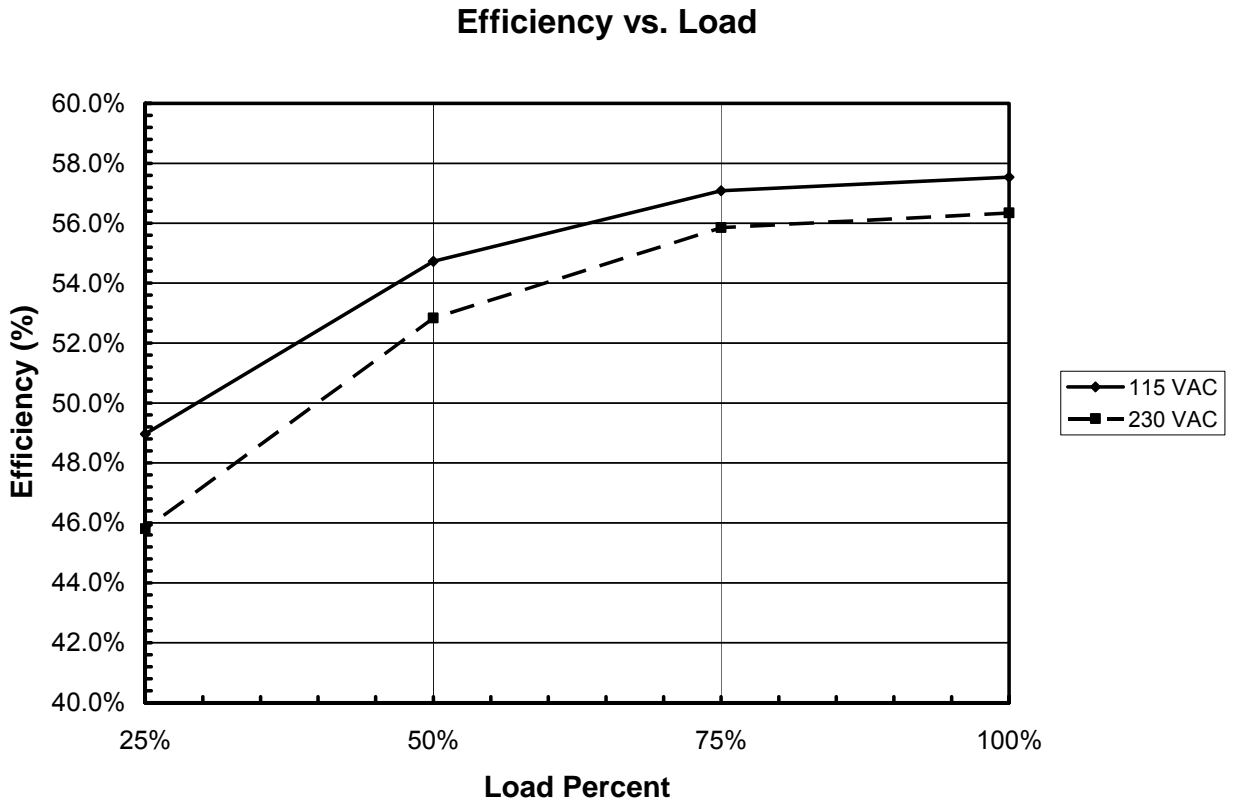

Figure 4 – Efficiency vs. Output Power, Room Temperature, 60 Hz.

7.1.1 Active Mode CEC Measurement Data

All single output adapters, including those provided with products, for sale in California after July 1st, 2008, must meet the California Energy Commission (CEC) requirement for minimum active mode efficiency and no load input power. Minimum active mode efficiency is defined as the average efficiency of 25, 50, 75 and 100% of rated output power with the limit based on the nameplate output power:

Nameplate Output (P_o)	Minimum Efficiency in Active Mode of Operation
< 1 W	$0.50 \times P_o$
≥ 1 W to ≤ 49 W	$0.09 \times \ln(P_o) + 0.50$ [ln = natural log]
> 49 W	0.85



For adapters that are single input voltage only, the measurement is made at the rated single nominal input voltage (115 VAC or 230 VAC); for universal input adapters, the measurement is made at both nominal input voltages (115 VAC and 230 VAC).

To meet the standard, the measured average efficiency (or efficiencies for universal input supplies) must be greater than or equal to the efficiency specified by the CEC/Energy Star standard.

Percent of Full Load	Efficiency (%)	
	115 VAC	230 VAC
25	57.5	56.3
50	57.1	55.9
75	54.7	52.8
100	49.0	45.8
Average	54.6	52.7
CEC specified minimum average efficiency (%)	51.7*	

Table 1 – CEC Efficiency Table.

*Although the CEC standard does not apply to this design, the data are provided for reference.

More states within the USA and other countries are adopting this standard. For the latest information, please visit the PI Green Room:

<http://www.powerint.com/greenroom/regulations.htm>



7.2 No-load Input Power

No Load Power Consumption vs. Input Voltage

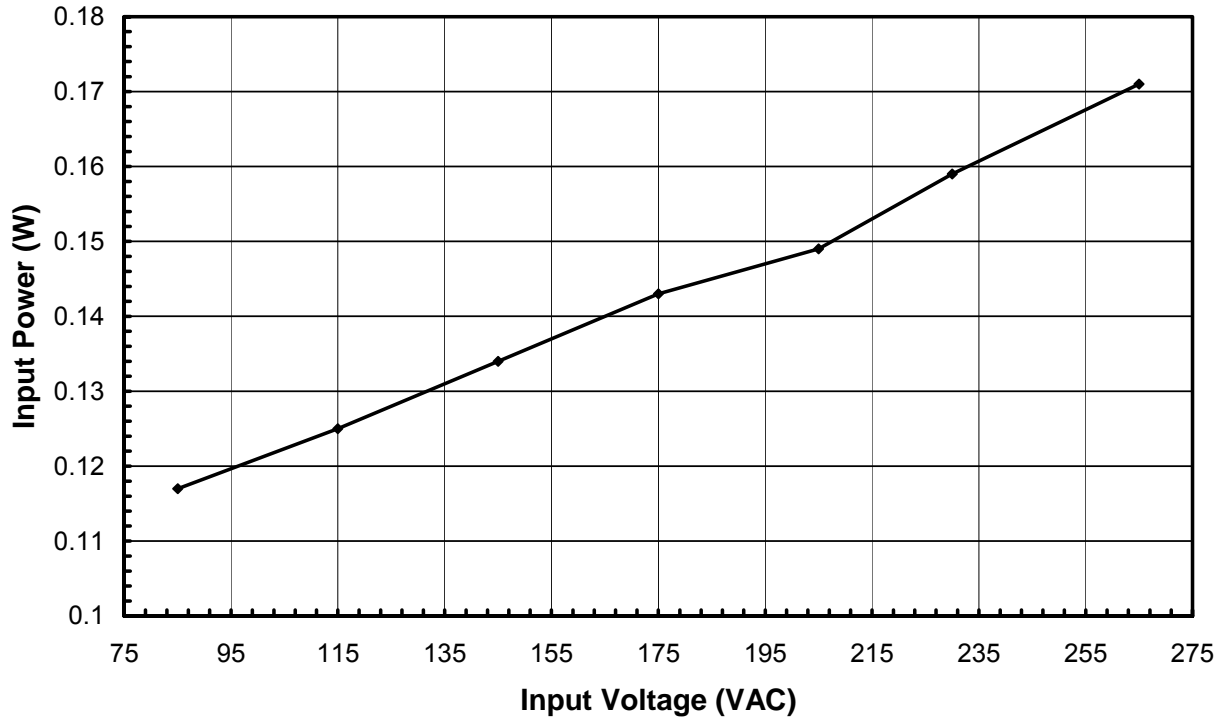

Figure 5 – Zero Load Input Power vs. Input Line Voltage, Room Temperature, 60 Hz.

7.3 Regulation

7.3.1 Load and Line

5 V Output

The 12 V output was loaded to $I_{O(12VMIN)}$, and the 5 V load current was swept from $I_{O(5VMIN)}$ to $I_{O(5VMAX)}$. This was then repeated while 12 V output was loaded to $I_{O(12VMAX)}$.

12 V Output

The 5 V output was loaded to $I_{O(5VMIN)}$, and the 12 V load current was swept from $I_{O(12VMIN)}$ to $I_{O(12VMAX)}$. This was then repeated while 5 V output was loaded to $I_{O(5VMAX)}$.



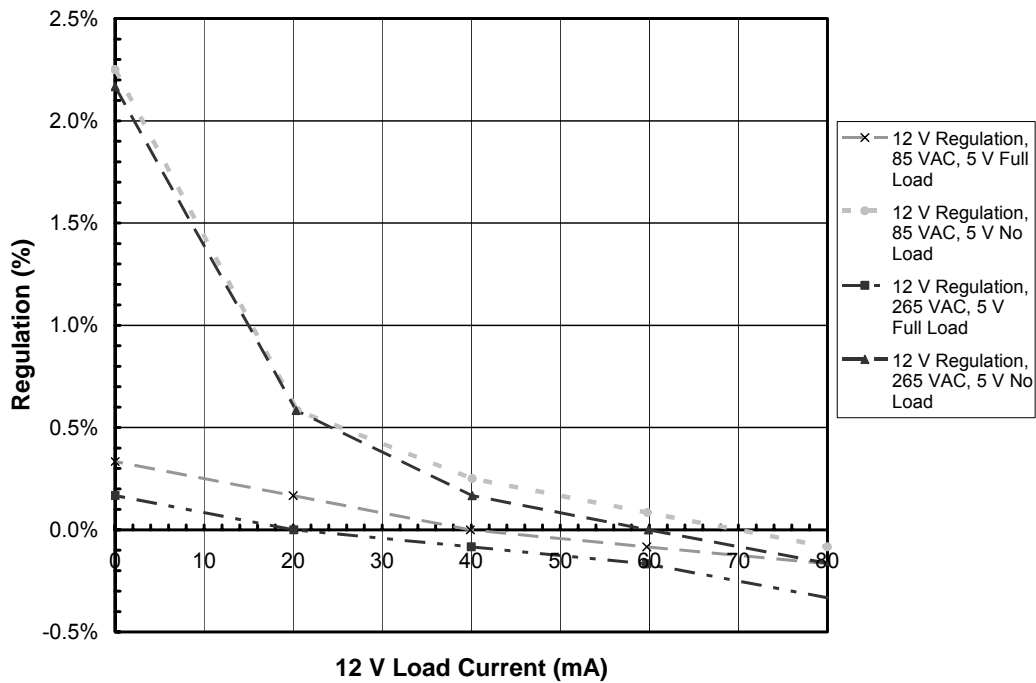

Figure 6 – 12 V Load Line and Load Regulation (5 V Min / Max Load, 85 VAC and 265 VAC), 25 °C.

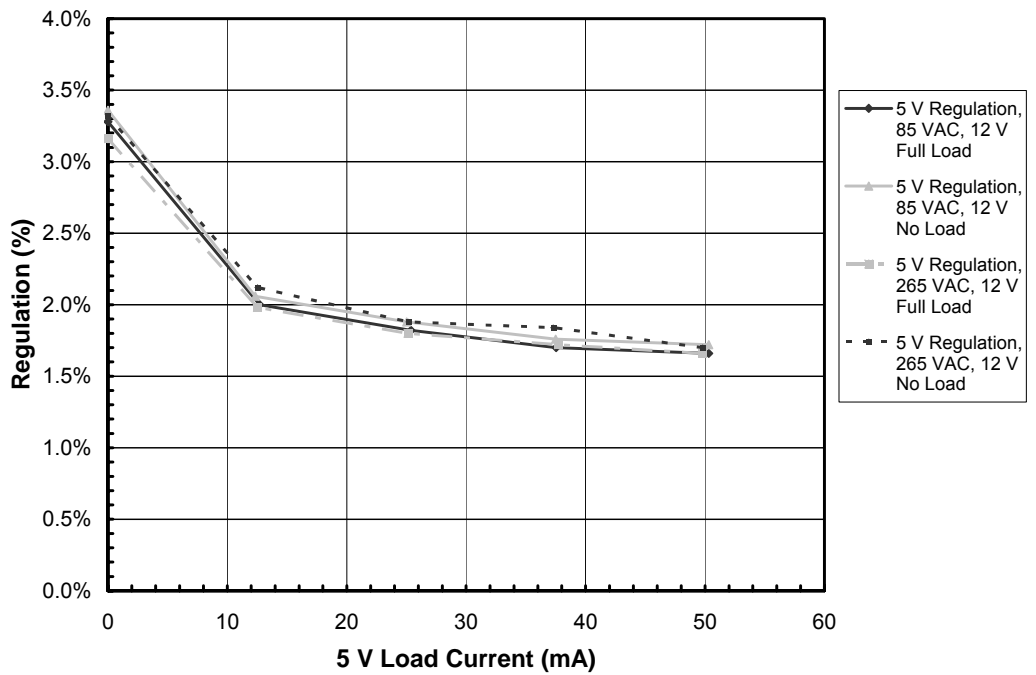

Figure 7 – 5 V Load Line and Load Regulation (12 V Min / Max Load, 85 VAC and 265 VAC), 25 °C.



7.3.2 Line

Full Load Output Regulation vs. Input Voltage

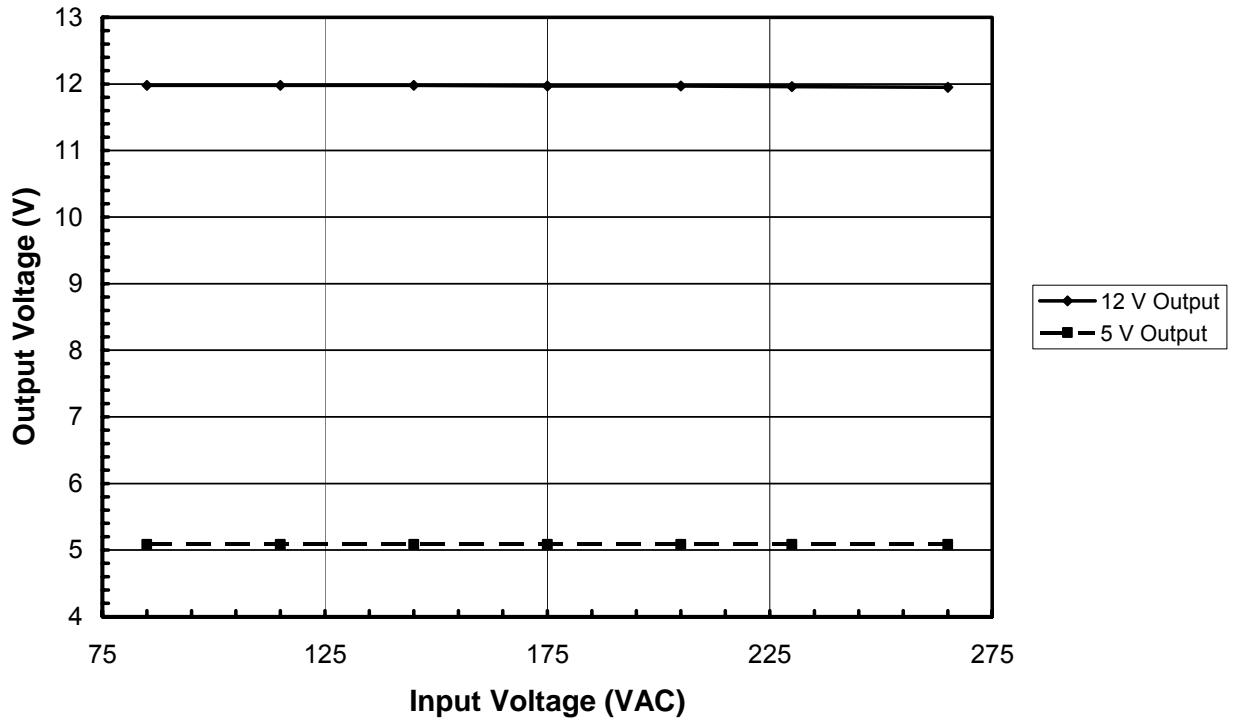

Figure 8 – Line Regulation, Room Temperature, Full Load.



8 Thermal Performance

Table 2 shows the thermal performance at 50 °C ambient temperature.

Item	Temperature (°C)	
	86 VAC	265 VAC
Ambient	50	50
Device (U1)	76	81
Anode of Output Diode (D2)	76	80
Collector of Transistor (Q2)	87	90
Output Inductor (L2)	73	76

Table 2 – Thermal Measurements Taken.

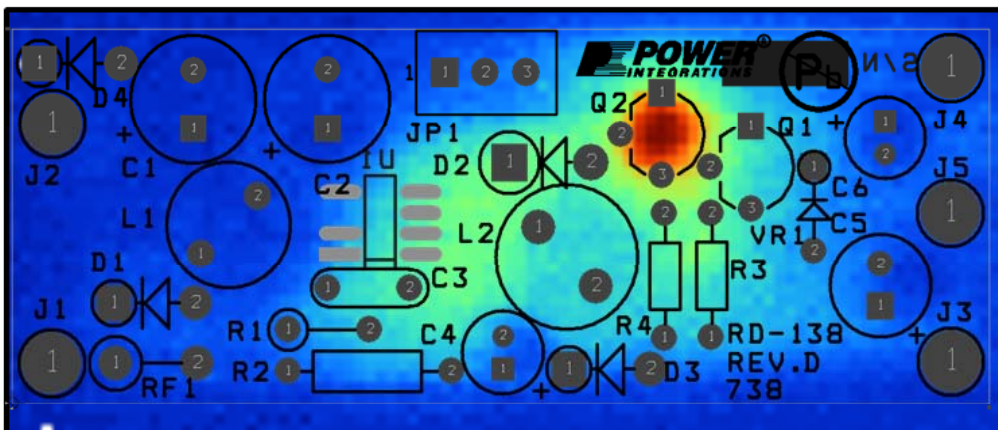

Figure 9 – Top Side Thermal Image.

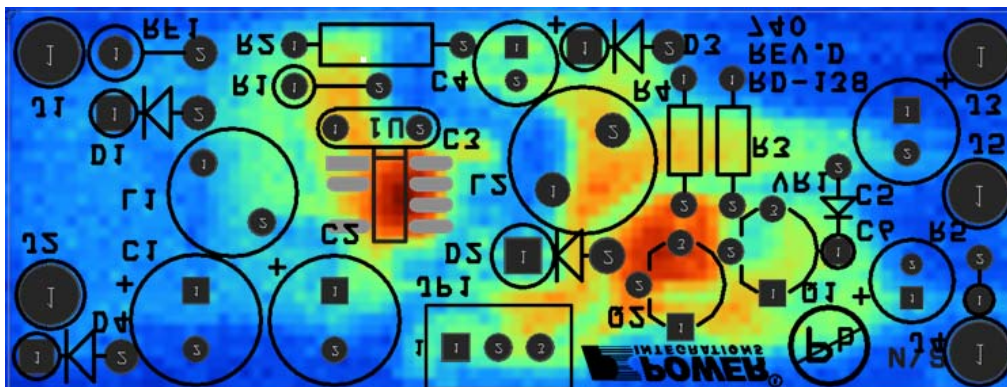

Figure 10 – Bottom Side Thermal Image.



9 Waveforms

9.1 Drain Voltage and Current, Normal Operation

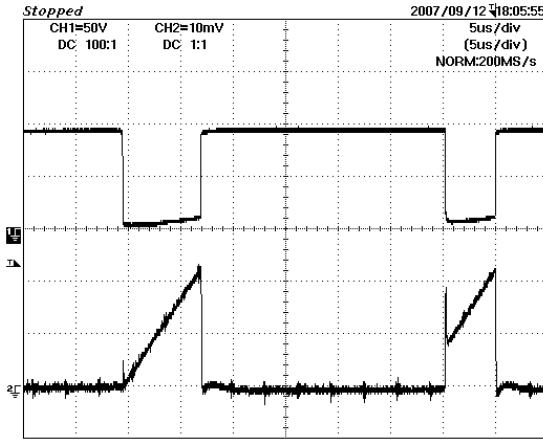

Figure 11 – 85 VAC, V_{DC} To V_{SOURCE} , Full Load.
 Upper: V_{SOURCE} , 50 V / div, 5 μ s/div.
 Lower: I_{DRAIN} , 0.1 A / div.

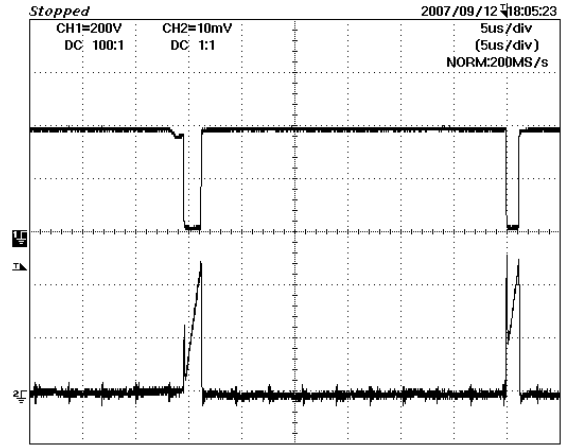

Figure 12 – 265 VAC, V_{DC} To V_{SOURCE} , Full Load.
 Upper: V_{SOURCE} , 200 V / div, 5 μ s/div.
 Lower: I_{DRAIN} , 0.1 A / div.

9.2 Output Voltage Start-up Profile

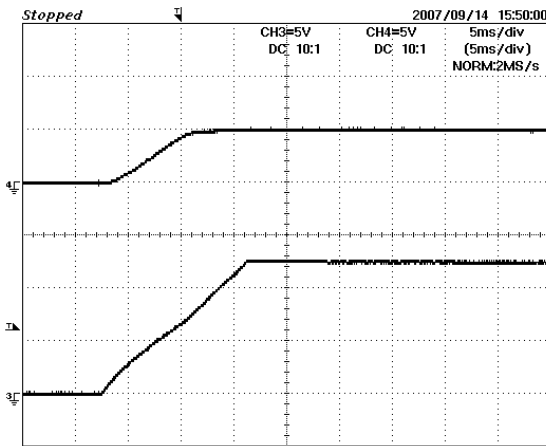

Figure 13 – Start-up Profile, 85 VAC.
 Upper: 5 V Output, 5 V / div.
 Lower: 12 V Output, 5 V / div.
 Time base: 5 ms / div.

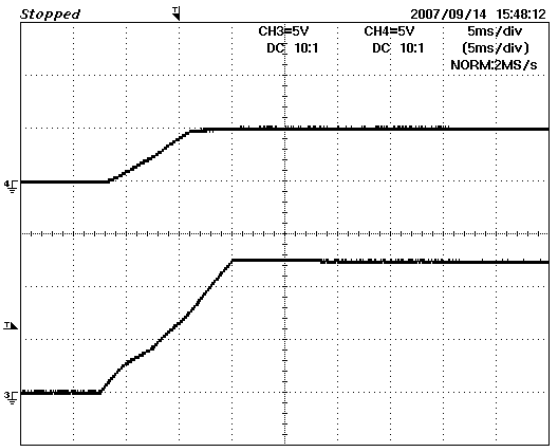

Figure 14 – Start-up Profile, 265 VAC.
 Upper: 5 V Output, 5 V / div.
 Lower: 12 V Output, 5 V / div.
 Time base: 5 ms / div.



9.3 Source Voltage and Drain Current Start-up Profile

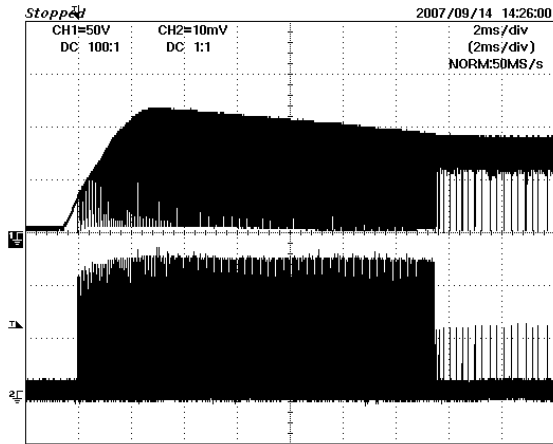

Figure 15 – 85 VAC Input and Maximum Load.
 Upper: V_{DC} To V_{SOURCE} , 50 V.
 Lower: I_{DRAIN} , 0.2 A / div.
 Time base: 2 ms / div.

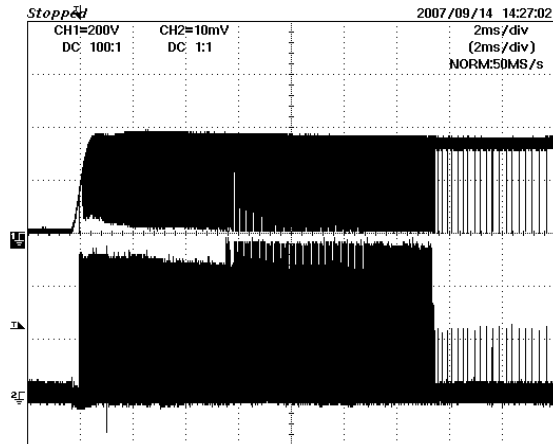

Figure 16 – 265 VAC Input and Maximum Load.
 Upper: V_{DC} To V_{SOURCE} , 200 V.
 Lower: I_{DRAIN} , 0.2 A / div.

9.4 Load Transient Response (75% to 100% Load Step)

In the figures shown below, signal averaging was used to better enable viewing the load transient response. The oscilloscope was triggered using the load current step as a source. Since the output switching and line frequency occur essentially at random with respect to the load transient, contributions to the output ripple from these sources will average out, leaving the contribution only from the load step response.

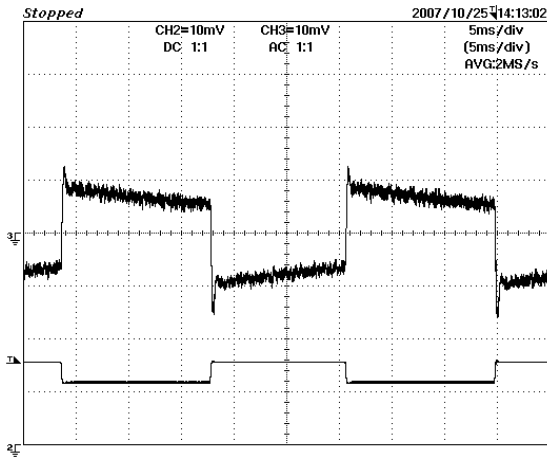

Figure 17 – Transient Response, 85 VAC.
75-100-75% Load Step. On 12 V Output.
Upper: 12 V Output, 10 mV / div.
Lower: 12 V Load Current 50 mA / div.
Timebase: 5 ms / div.

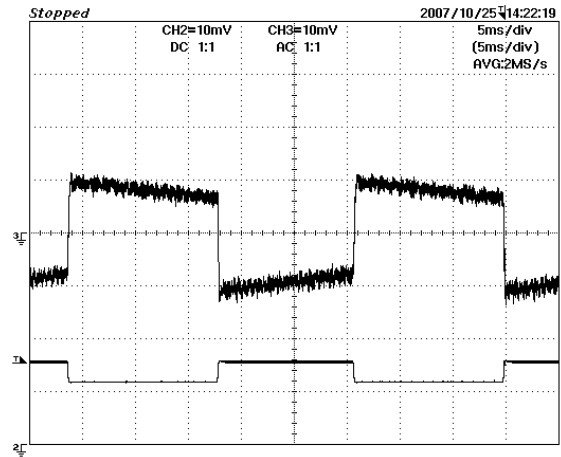

Figure 18 – Transient Response, 265 VAC.
75-100-75% Load Step On 12 V Output.
Upper: 5 V Output, 10 mV / div.
Bottom: 12 V Load Current 50 mA / div.
Timebase: 5 ms / div.



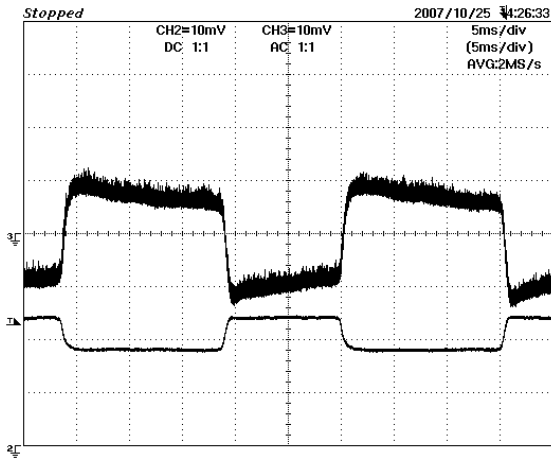

Figure 19 – Transient Response, 85 VAC.
75-100-75% Load Step on 5 V Output.
Upper: 5 V Output, 10 mV / div.
Lower: 5 V Load Current 20 mA / div.
Timebase: 5 ms / div.

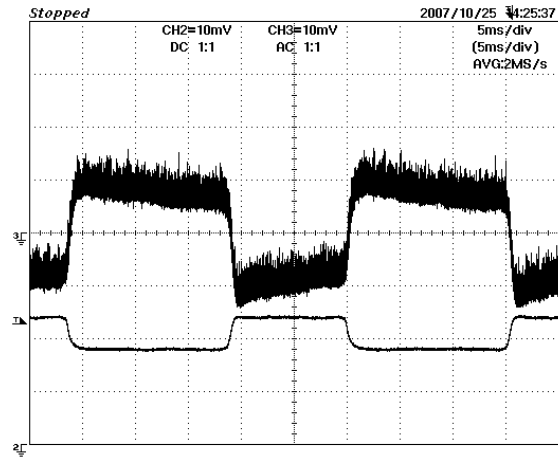

Figure 20 – Transient Response, 265 VAC.
75-100-75% Load Step on 5 V Output.
Upper: 5 V Output, 10 mV / div.
Lower: 5 V Load Current 20 mA / div.
Timebase: 5 ms / div.



9.5 Output Ripple Measurements

9.5.1 Ripple Measurement Technique

For DC output ripple measurements, a modified oscilloscope test probe must be utilized in order to reduce spurious signals due to pickup. Details of the probe modification are provided in Figure 21 and Figure 22.

The 4987BA probe adapter is affixed with two capacitors tied in parallel across the probe tip. The capacitors include one (1) 0.1 $\mu\text{F}/50\text{ V}$ ceramic type and one (1) 1.0 $\mu\text{F}/50\text{ V}$ aluminum electrolytic type. The aluminum electrolytic type capacitor is polarized, so proper polarity across DC outputs must be maintained (see below).

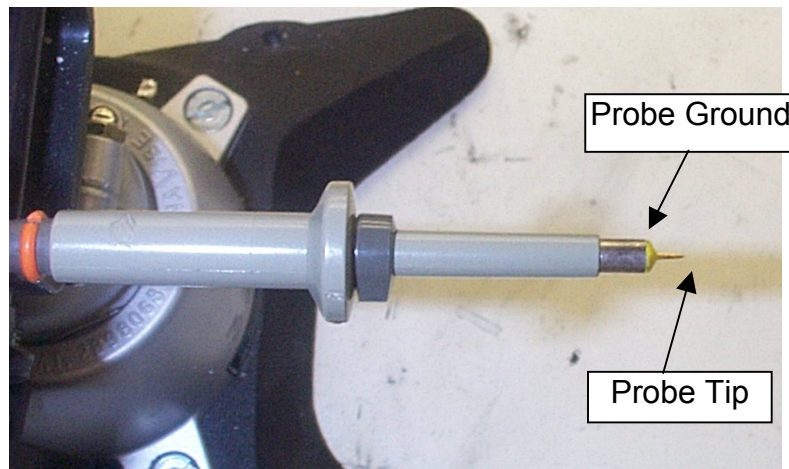

Figure 21 – Oscilloscope Probe Prepared for Ripple Measurement. (End Cap and Ground Lead Removed)



Figure 22 – Oscilloscope Probe with Probe Master (www.probemaster.com) 4987A BNC Adapter. (Modified with Wires for Ripple Measurement, and Two Parallel Decoupling Capacitors Added)

9.5.2 Measurement Results

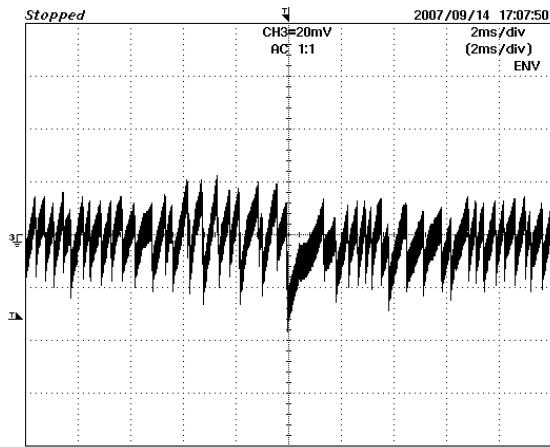

Figure 23 – 12 V Ripple, 85 VAC, Full Load.
20 mV / div, 2 ms / div.

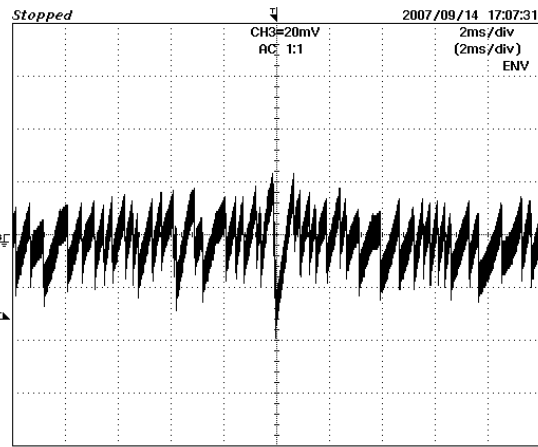

Figure 24 – 12 V Ripple, 265 VAC, Full Load.
20 mV / div, 2 ms / div.

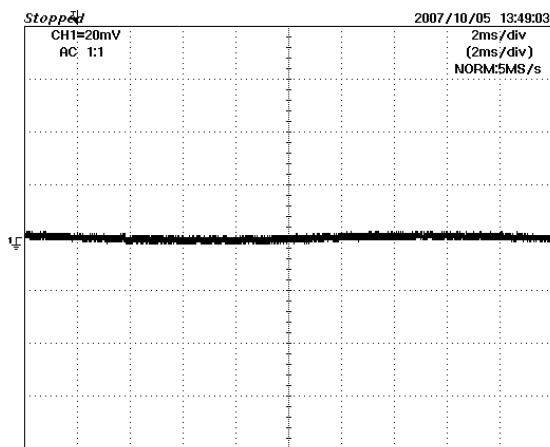

Figure 25 – 5 V Ripple, 85 VAC, Full Load.
2 ms, 20 mV /div.

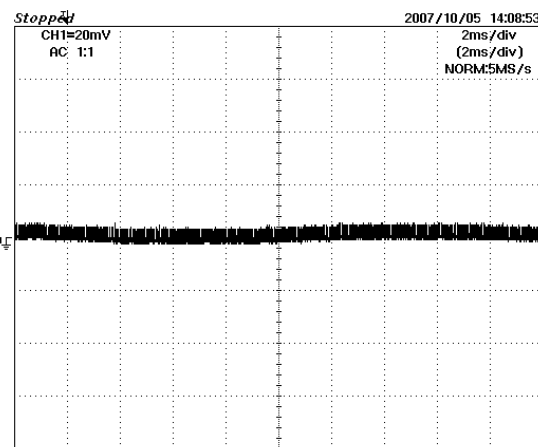

Figure 26 – 5 V Ripple, 265 VAC, Full Load.
2 ms, 20 mV /div.



10 Conducted EMI

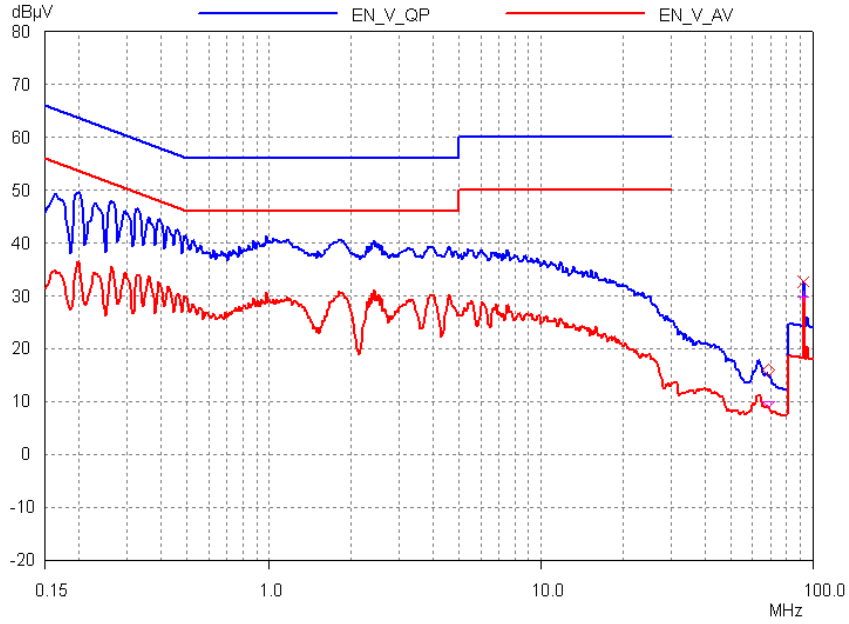

Figure 27 – Worst Case Conducted EMI, Measured at Full Load, 230 VAC Input, 60 Hz, Neutral Conductor, EN55022B Limits Shown.

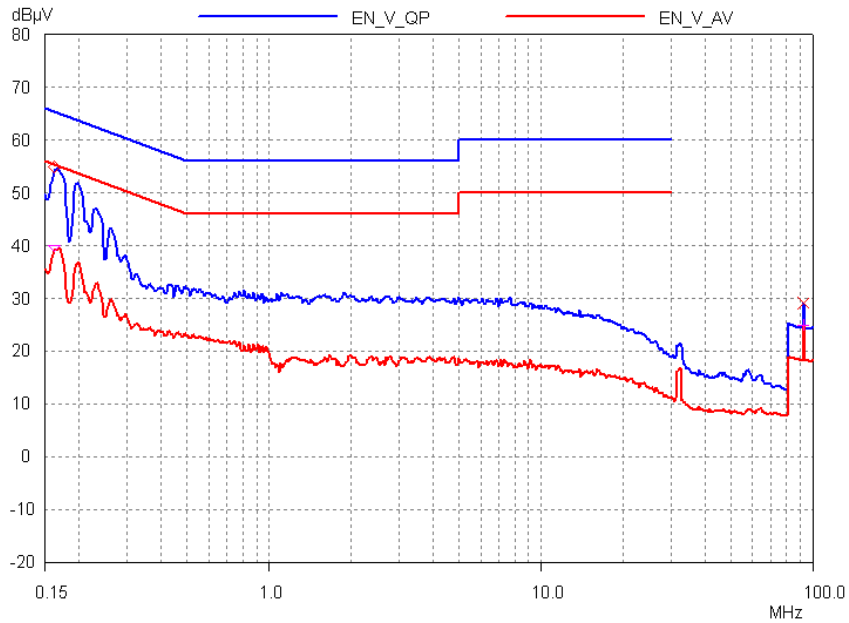

Figure 28 – Worst Case Conducted EMI, Measured at Full Load, 115 VAC Input, 60 Hz, Neutral Conductor, EN55022B Limits Shown.

11 Line Surge

Differential and Common mode 1.2/50 μ s surge testing was completed on a single test unit to IEC61000-4-5. Input voltage was set at 230 VAC / 60 Hz. Output was loaded at full load, and operation was verified following each surge event.

Event	Surge Level (V)	Input Voltage (VAC)	Injection Location	Injection Phase (°)	Test Result (Pass/Fail)
1	+1000	230	L to N	90	Pass
2	+1000	230	L to N	90	Pass
3	+1000	230	L to N	90	Pass
4	+1000	230	L to N	90	Pass
5	+1000	230	L to N	90	Pass
6	+1000	230	L to N	90	Pass
7	+1000	230	L to N	90	Pass
8	+1000	230	L to N	90	Pass
9	+1000	230	L to N	90	Pass
10	+1000	230	L to N	90	Pass
1	-1000	230	L to N	270	Pass
2	-1000	230	L to N	270	Pass
3	-1000	230	L to N	270	Pass
4	-1000	230	L to N	270	Pass
5	-1000	230	L to N	270	Pass
6	-1000	230	L to N	270	Pass
7	-1000	230	L to N	270	Pass
8	-1000	230	L to N	270	Pass
9	-1000	230	L to N	270	Pass
10	-1000	230	L to N	270	Pass

Unit passes under all test conditions.



12 Revision History

Date	Author	Revision	Description & changes	Reviewed
12-Nov-07	KM	1.0	Initial Release.	



Notes



Notes



For the latest updates, visit our website: www.powerint.com

Power Integrations reserves the right to make changes to its products at any time to improve reliability or manufacturability. Power Integrations does not assume any liability arising from the use of any device or circuit described herein. POWER INTEGRATIONS MAKES NO WARRANTY HEREIN AND SPECIFICALLY DISCLAIMS ALL WARRANTIES INCLUDING, WITHOUT LIMITATION, THE IMPLIED WARRANTIES OF MERCHANTABILITY, FITNESS FOR A PARTICULAR PURPOSE, AND NON-INFRINGEMENT OF THIRD PARTY RIGHTS.

PATENT INFORMATION

The products and applications illustrated herein (including transformer construction and circuits external to the products) may be covered by one or more U.S. and foreign patents, or potentially by pending U.S. and foreign patent applications assigned to Power Integrations. A complete list of Power Integrations' patents may be found at www.powerint.com. Power Integrations grants its customers a license under certain patent rights as set forth at <http://www.powerint.com/ip.htm>.

The PI Logo, **TOPSwitch**, **TinySwitch**, **LinkSwitch**, **DPA-Switch**, **PeakSwitch**, **EcoSmart**, **Clampless**, **E-Shield**, **Filterfuse**, **StackFET**, **PI Expert** and **PI FACTS** are trademarks of Power Integrations, Inc. Other trademarks are property of their respective companies. ©Copyright 2007 Power Integrations, Inc.

Power Integrations Worldwide Sales Support Locations

WORLD HEADQUARTERS

5245 Hellyer Avenue
San Jose, CA 95138, USA.
Main: +1-408-414-9200
Customer Service:
Phone: +1-408-414-9665
Fax: +1-408-414-9765
e-mail: usasales@powerint.com

GERMANY

Rueckertstrasse 3
D-80336, Munich
Germany
Phone: +49-89-5527-3911
Fax: +49-89-5527-3920
e-mail: eurossales@powerint.com

JAPAN

Kosei Dai-3 Bldg.,
2-12-11, Shin-Yokohama,
Kohoku-ku, Yokohama-shi,
Kanagawa 222-0033
Phone: +81-45-471-1021
Fax: +81-45-471-3717
e-mail: japansales@powerint.com

TAIWAN

5F, No. 318, Nei Hu Rd., Sec. 1
Nei Hu Dist.
Taipei, Taiwan 114, R.O.C.
Phone: +886-2-2659-4570
Fax: +886-2-2659-4550
e-mail: taiwansales@powerint.com

CHINA (SHANGHAI)

Rm 807-808A,
Pacheer Commercial Centre,
555 Nanjing Rd. West
Shanghai, P.R.C. 200041
Phone: +86-21-6215-5548
Fax: +86-21-6215-2468
e-mail: chinasales@powerint.com

INDIA

#1, 14th Main Road
Vasanthanagar
Bangalore-560052 India
Phone: +91-80-41138020
Fax: +91-80-41138023
e-mail: indiasales@powerint.com

KOREA

RM 602, 6FL
Korea City Air Terminal B/D,
159-6
Samsung-Dong, Kangnam-Gu,
Seoul, 135-728, Korea
Phone: +82-2-2016-6610
Fax: +82-2-2016-6630
e-mail: koreasales@powerint.com

UNITED KINGDOM

1st Floor, St. James's House
East Street, Farnham
Surrey, GU9 7TJ
United Kingdom
Phone: +44 (0) 1252-730-141
Fax: +44 (0) 1252-727-689
e-mail: eurossales@powerint.com

CHINA (SHENZHEN)

Room A, B & C 4th Floor, Block C
Elec. Sci. Tech. Bldg.
2070 Shennan Zhong Rd.
Shenzhen, Guangdong,
China, 518031
Phone: +86-755-8379-3243
Fax: +86-755-8379-5828
e-mail: chinasales@powerint.com

ITALY

Via De Amicis 2
20091 Bresso MI – Italy
Phone: +39-028-928-6000
Fax: +39-028-928-6009
e-mail: eurossales@powerint.com

SINGAPORE

51 Newton Road,
#15-08/10 Goldhill Plaza,
Singapore, 308900
Phone: +65-6358-2160
Fax: +65-6358-2015
e-mail: singaporesales@powerint.com

APPLICATIONS HOTLINE

World Wide +1-408-414-9660

APPLICATIONS FAX

World Wide +1-408-414-9760



Power Integrations

Tel: +1 408 414 9200 Fax: +1 408 414 9201
www.powerint.com

Компания «Океан Электроники» предлагает заключение долгосрочных отношений при поставках импортных электронных компонентов на взаимовыгодных условиях!

Наши преимущества:

- Поставка оригинальных импортных электронных компонентов напрямую с производств Америки, Европы и Азии, а так же с крупнейших складов мира;
- Широкая линейка поставок активных и пассивных импортных электронных компонентов (более 30 млн. наименований);
- Поставка сложных, дефицитных, либо снятых с производства позиций;
- Оперативные сроки поставки под заказ (от 5 рабочих дней);
- Экспресс доставка в любую точку России;
- Помощь Конструкторского Отдела и консультации квалифицированных инженеров;
- Техническая поддержка проекта, помощь в подборе аналогов, поставка прототипов;
- Поставка электронных компонентов под контролем ВП;
- Система менеджмента качества сертифицирована по Международному стандарту ISO 9001;
- При необходимости вся продукция военного и аэрокосмического назначения проходит испытания и сертификацию в лаборатории (по согласованию с заказчиком);
- Поставка специализированных компонентов военного и аэрокосмического уровня качества (Xilinx, Altera, Analog Devices, Intersil, Interpoint, Microsemi, Actel, Aeroflex, Peregrine, VPT, Syfer, Eurofarad, Texas Instruments, MS Kennedy, Miteq, Cobham, E2V, MA-COM, Hittite, Mini-Circuits, General Dynamics и др.);

Компания «Океан Электроники» является официальным дистрибьютором и эксклюзивным представителем в России одного из крупнейших производителей разъемов военного и аэрокосмического назначения «JONHON», а так же официальным дистрибьютором и эксклюзивным представителем в России производителя высокотехнологичных и надежных решений для передачи СВЧ сигналов «FORSTAR».



JONHON

«JONHON» (основан в 1970 г.)

Разъемы специального, военного и аэрокосмического назначения:

(Применяются в военной, авиационной, аэрокосмической, морской, железнодорожной, горно- и нефтедобывающей отраслях промышленности)

«FORSTAR» (основан в 1998 г.)

ВЧ соединители, коаксиальные кабели, кабельные сборки и микроволновые компоненты:

(Применяются в телекоммуникациях гражданского и специального назначения, в средствах связи, РЛС, а так же военной, авиационной и аэрокосмической отраслях промышленности).



Телефон: 8 (812) 309-75-97 (многоканальный)

Факс: 8 (812) 320-03-32

Электронная почта: ocean@oceanchips.ru

Web: <http://oceanchips.ru/>

Адрес: 198099, г. Санкт-Петербург, ул. Калинина, д. 2, корп. 4, лит. А