

General Specifications

Electrical Capacity (Resistive Load)

Power Level (silver): 6A @ 125V AC or 3A @ 250V AC or 6A @ 12V DC for silver
Logic Level (gold): 0.4VA maximum @ 28V AC/DC maximum for gold
 (Applicable Range 0.1mA ~ 0.1A @ 20mV ~ 28V)
 Note: See Supplement Index for explanation of operating range.

Other Ratings

Contact Resistance: 10 milliohms maximum for silver; 20 milliohms maximum for gold
Insulation Resistance: 1,000 megohms minimum @ 500V DC
Dielectric Strength: 1,000V AC minimum between contacts for 1 minute minimum;
 1,500V AC minimum between contacts & case for 1 minute minimum
Mechanical Life: 50,000 operations minimum
Electrical Life: 25,000 operations minimum for silver; 50,000 operations minimum for gold
Static Capability: Withstands 20 kilovolts ESD minimum
Nominal Operating Force: 1.9N for .689" (17.5mm) toggle; 2.5N for .433" (11.0mm) toggle
Angle of Throw: 25°

Materials & Finishes

Toggle: Polycarbonate
Housing: Glass fiber reinforced polyamide
Sealing Ring: Nitrile butadiene rubber
Base: Diallyl phthalate (UL94V-0)
Movable Contactor: Phosphor bronze with silver or gold plating
Movable Contacts: Silver alloy or copper with gold plating
Stationary Contact: Silver plus copper with silver plating or copper with gold plating
Lamp Contacts: Beryllium copper with silver plating
Power Terminals: Copper with silver or gold plating
Lamp Terminals: Brass with silver plating

Environmental Data

Operating Temperature Range: -10°C through +55°C (+14°F through +131°F)
Humidity: 90 ~ 95% humidity for 240 hours @ 40°C (104°F)
Vibration: 10 ~ 55Hz with peak-to-peak amplitude of 1.5mm traversing the frequency range & returning in 1 minute; 3 right angled directions for 1.75 hours
Shock: 50G (490m/s²) acceleration (tested in 6 right angled directions, with 5 shocks in each direction)

Installation

Mounting Torque: .98Nm (8.67 lb•in) maximum
Soldering Time & Temperature: Manual Soldering: See Profile B in Supplement section.

Standards & Certifications

Flammability Standards: UL94V-0 base

Distinctive Characteristics

Choice of long or short toggles in translucent colors combine with bright LEDs available in red, amber, and green, plus super bright LEDs available in white, green, and blue.

Black face nut enhances front panel appearance.

Antistatic material used for toggle withstands 20 kilovolts electrostatic discharge.

Panel seal, achieved with use of optional exterior o-ring, conforms to IP65 of IEC60529 Standards.

Interior o-ring protects contacts from oil, dust, water, and other contaminants.

UL94V-0 flammability rated for base.

High insulating barriers protect against crossover.

Terminals are molded in and epoxy sealed to lock out flux, dust, and other contaminants.

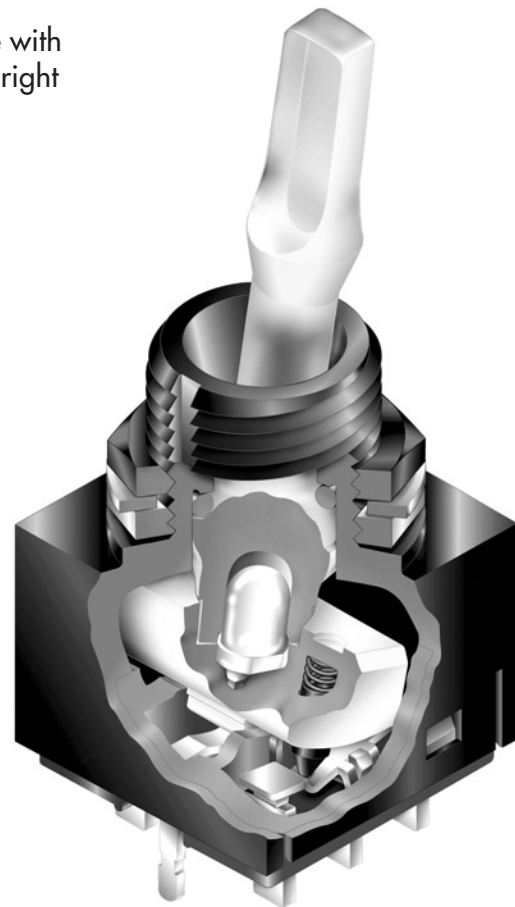

Actual Size

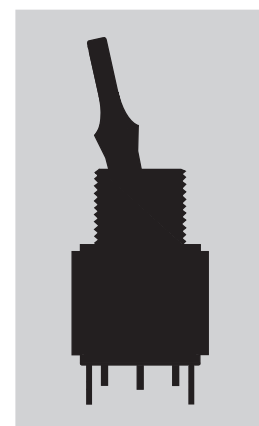

A

Toggles

Rockers

Pushbuttons

Illuminated PB

Programmable

Keylocks

Rotaries

Slides

Tactiles

Tilt

Touch

Indicators

Accessories

Supplement

TYPICAL SWITCH ORDERING EXAMPLE

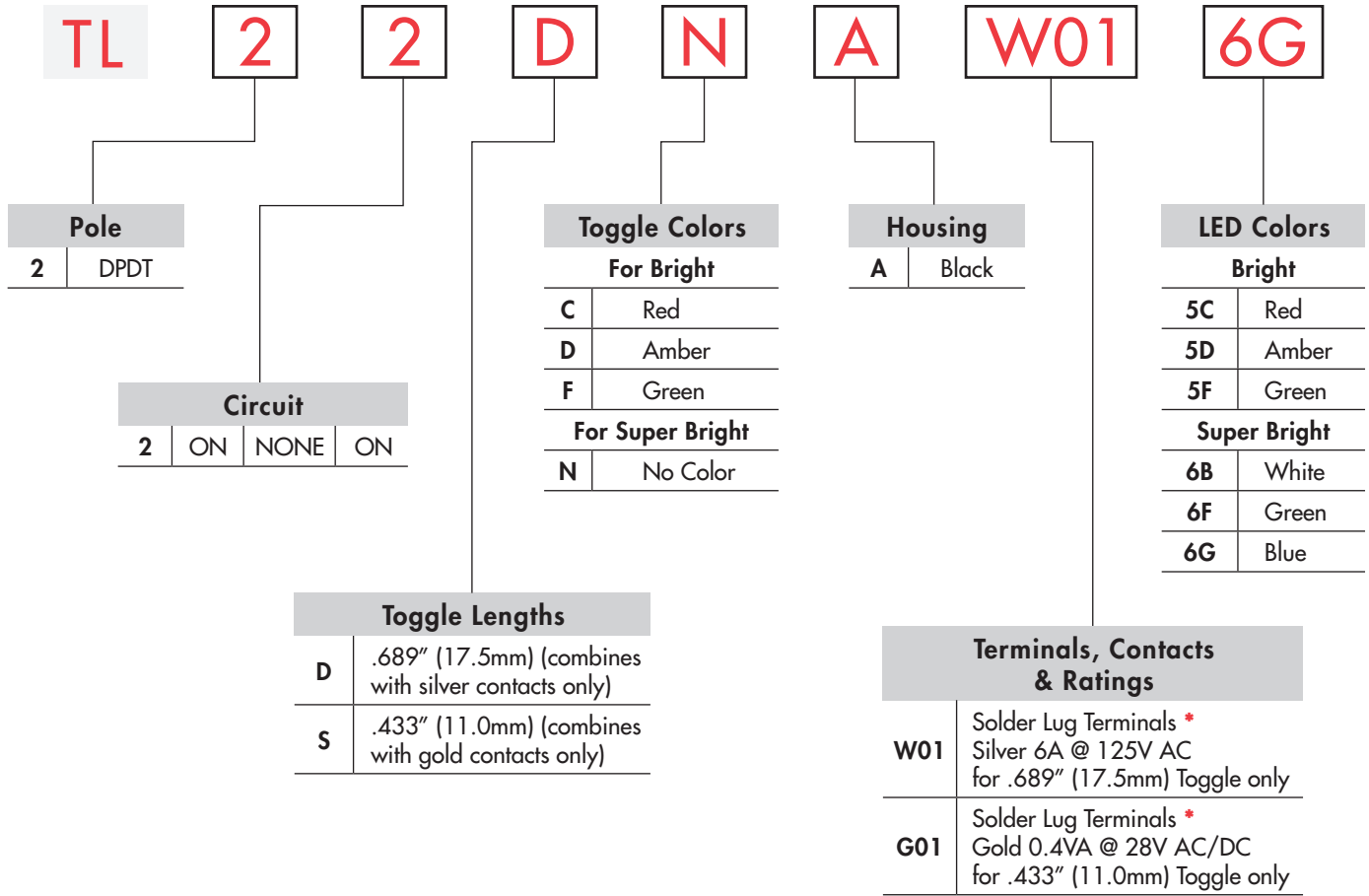



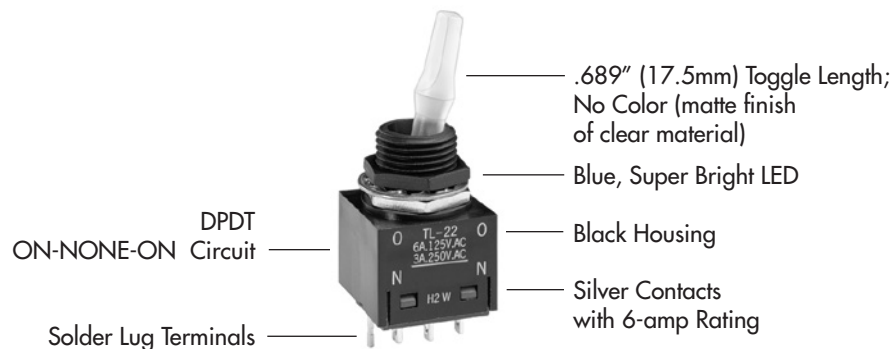

* Wire harness & cable assemblies offered only in Americas

DESCRIPTION FOR TYPICAL ORDERING EXAMPLE

TL22DNAW016G

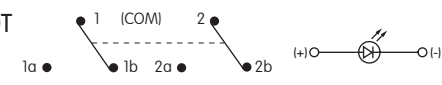

POLE & CIRCUIT

		Toggle Position			Connected Terminals			Throw & Power/Lamp Schematics
Pole	Model	Down 	Center	Up 	Down 	Center	Up 	Notes: Terminal numbers are not actually on switch. Lamp circuit is isolated and requires an external power source.
DP	TL22	ON	NONE	ON	1-1b 2-2b	OPEN	1-1a 2-2a	DPDT 

TOGGLE LENGTHS & COLORS

D .689"
(17.5mm)

Combines with Silver Contacts only

Material: Polycarbonate

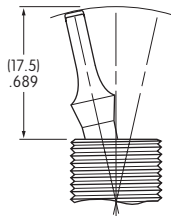

S .433"
(11.0mm)

Combines with Gold Contacts only

Material: Polycarbonate

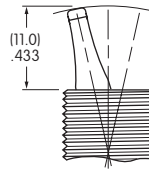

Colors Available for Bright LED

C Red **D** Amber **F** Green

Color Available for Super Bright LED

N No Color (Appearance is matte finish of clear material)

HOUSING

A Black

The housing consists of the one-piece bushing/case of glass fiber reinforced polyamide in black color only.

The diallyl phthalate material used for the base is UL flammability rated 94V-0; housing material is not.

CONTACT MATERIALS, RATINGS, & TERMINALS

W

Silver Contacts Power Level
6A @ 125V AC & 3A @ 250V AC
& 6A @ 12V DC

01

Solder Lug Terminals

G

Gold Contacts Logic Level
0.4VA maximum @ 28V AC/DC

See Supplement Index for complete explanation of operating range.

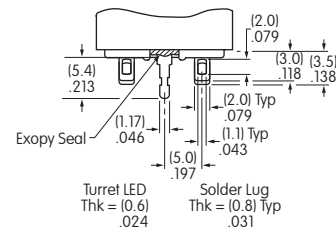

LED CODES & SPECIFICATIONS

Electrical specifications are determined at a basic temperature of 25°C. Lamp circuit is independent of switch operation.

If the source voltage is greater than rated voltage, a ballast resistor is required.

The ballast resistor calculation and more lamp detail are shown in Supplement section.

Super Bright LEDs are Electrostatic Sensitive	ATTENTION ELECTROSTATIC SENSITIVE DEVICES	Colored Toggles			Clear Toggles		
		5 Bright			6 Super Bright		
LED Factory Assembled Not Available Separately	Color	C Red	D Amber	F Green	B White	F Green	G Blue
Forward Peak Current	I_{FM}	30mA	30mA	50mA	30mA	30mA	30mA
Typical Forward Current	I_F	20mA	20mA	20mA	20mA	20mA	20mA
Forward Voltage	V_F	2.0V	2.1V	2.27V	3.6V	3.5V	3.6V
Reverse Peak Voltage	V_{RM}	4V	4V	4V	5V	5V	5V
Current Reduction Rate Above 25°C	ΔI_F	0.32mA/°C	0.32mA/°C	0.50mA/°C	0.50mA/°C	0.50mA/°C	0.50mA/°C
Ambient Temperature Range		-10°C ~ +55°C			-10°C ~ +55°C		

TYPICAL SWITCH DIMENSIONS

17.5mm Toggle

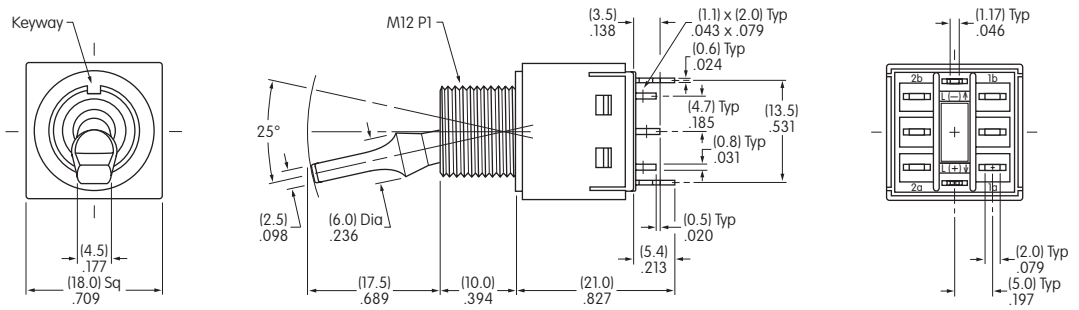

TL22DNAW016G

11.0mm Toggle

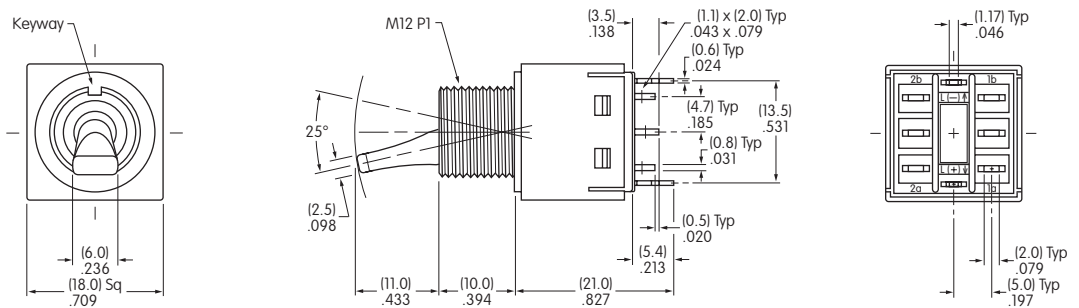

TL22SCAG015C

STANDARD HARDWARE

OPTIONAL HARDWARE

AT527MA Black Hex Nut
Use as Face Nut
Chrome/Steel

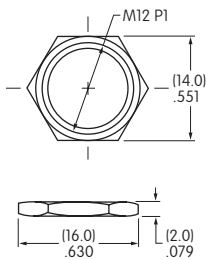

AT527M Hex Nut
Use as Backup Nut
Nickel/Steel

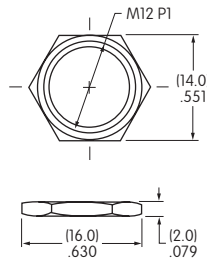

AT508 Lockwasher
Not to use with Panel Seal
Steel with Chromate/Zinc

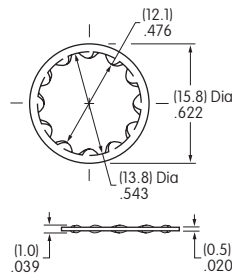

AT401P O-ring
Use for Panel Seal
Nitrile butadiene rubber

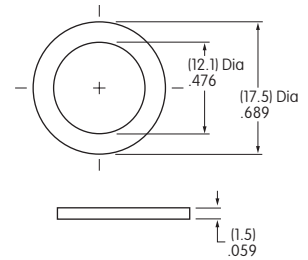

Hardware details in Accessories & Hardware section.

Panel Cutouts

Maximum Panel Thickness
with Standard Hardware
.157" (4.0mm)

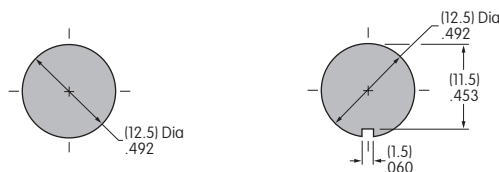

Maximum Panel Thickness
with Standard Hardware
& AT401P O-ring
.236" (6.0mm)

Компания «Океан Электроники» предлагает заключение долгосрочных отношений при поставках импортных электронных компонентов на взаимовыгодных условиях!

Наши преимущества:

- Поставка оригинальных импортных электронных компонентов напрямую с производств Америки, Европы и Азии, а так же с крупнейших складов мира;
- Широкая линейка поставок активных и пассивных импортных электронных компонентов (более 30 млн. наименований);
- Поставка сложных, дефицитных, либо снятых с производства позиций;
- Оперативные сроки поставки под заказ (от 5 рабочих дней);
- Экспресс доставка в любую точку России;
- Помощь Конструкторского Отдела и консультации квалифицированных инженеров;
- Техническая поддержка проекта, помощь в подборе аналогов, поставка прототипов;
- Поставка электронных компонентов под контролем ВП;
- Система менеджмента качества сертифицирована по Международному стандарту ISO 9001;
- При необходимости вся продукция военного и аэрокосмического назначения проходит испытания и сертификацию в лаборатории (по согласованию с заказчиком);
- Поставка специализированных компонентов военного и аэрокосмического уровня качества (Xilinx, Altera, Analog Devices, Intersil, Interpoint, Microsemi, Actel, Aeroflex, Peregrine, VPT, Syfer, Eurofarad, Texas Instruments, MS Kennedy, Miteq, Cobham, E2V, MA-COM, Hittite, Mini-Circuits, General Dynamics и др.);

Компания «Океан Электроники» является официальным дистрибьютором и эксклюзивным представителем в России одного из крупнейших производителей разъемов военного и аэрокосмического назначения «JONHON», а так же официальным дистрибьютором и эксклюзивным представителем в России производителя высокотехнологичных и надежных решений для передачи СВЧ сигналов «FORSTAR».



JONHON

«JONHON» (основан в 1970 г.)

Разъемы специального, военного и аэрокосмического назначения:

(Применяются в военной, авиационной, аэрокосмической, морской, железнодорожной, горно- и нефтедобывающей отраслях промышленности)

«FORSTAR» (основан в 1998 г.)

ВЧ соединители, коаксиальные кабели, кабельные сборки и микроволновые компоненты:

(Применяются в телекоммуникациях гражданского и специального назначения, в средствах связи, РЛС, а так же военной, авиационной и аэрокосмической отраслях промышленности).



Телефон: 8 (812) 309-75-97 (многоканальный)

Факс: 8 (812) 320-03-32

Электронная почта: ocean@oceanchips.ru

Web: <http://oceanchips.ru/>

Адрес: 198099, г. Санкт-Петербург, ул. Калинина, д. 2, корп. 4, лит. А