

P1 Relay V23026

- Directly triggerable with TTL standard modules as ALS, HCT & ACT
- Slim line 13.5x7.85mm (0.531x0.309")
- Switching current 1 A
- Bifurcated 1 form C (CO) contact
- Immersion cleanable
- High sensitivity results in low nominal power consumption, 65 to 130mW for monostable and 30 to 150mW for bistable (latching)
- Initial surge withstand voltage
2.5kV (2/10µs) meets the Bellcore Requirement GR-1089
1.5kV (10/160µs) meets FCC Part 68

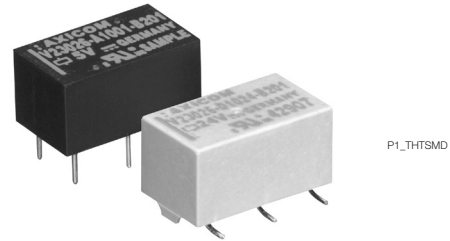

P1_THTSMD



Typical applications

Automotive equipment, CAN bus, immobilizer, office equipment, measurement and control equipment, medical equipment, safety equipment

Approvals

UL 508 File No. E 111441
Technical data of approved types on request

Contact Data

| | |
|-------------------------------------|---|
| Contact arrangement | 1 form C (CO) |
| Max. switching voltage | 125VDC, 150VAC |
| Rated current | 1A |
| Limiting continuous current, 85°C | 1A |
| Breaking capacity max. | see max. DC load breaking capacity |
| Contact material | Palladium nickel, gold-rhodium covered bifurcated contact |
| Contact style | bifurcated contact |
| Min. recommended contact load | 10mA at 20mV |
| Initial contact resistance | ≤50mΩ at 10mA/20mV |
| Frequency of operation without load | 200 ops./s |
| Operate/release time max. | 2ms |
| Set/reset time max. | 2ms |
| Bounce time max. | 3ms |
| Electrical endurance | |
| at 12V/10mA | typ. 50x10 ⁶ operations |
| at 6V/100mA | typ. 10x10 ⁶ operations |
| at 30V/1000mA | typ. 10x10 ³ operations |
| Contact ratings | |
| UL contact ratings, resistive load | 30VDC/1A 65VDC/0.46A 150VAC/0.46A |
| Mechanical endurance | typ. 10 ⁹ operations |

Max. DC load breaking capacity

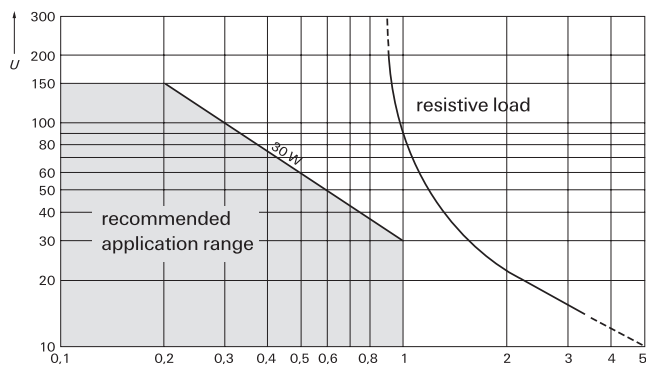

Coil Data

| | |
|----------------------------|--|
| Magnetic system | polarized |
| Coil voltage range | 3 to 24VDC other coil voltages on request |
| Operative range, IEC 61810 | see coil operative range |
| Max. coil temperature | 85°C |
| Thermal resistance | <130K/W |

Coil versions, THT, monostable

| Coil code | Rated voltage VDC | Operate voltage VDC _{min.} | Release voltage VDC _{min.} | Coil resistance Ω ±10% | Rated coil power mW |
|-----------|-------------------|-------------------------------------|-------------------------------------|------------------------|---------------------|
| 006 | 3 | 2.25 | 0.3 | 137 | 66 |
| 001 | 5 | 3.75 | 0.5 | 370 | 68 |
| 005 | 9 | 6.75 | 0.9 | 1165 | 70 |
| 002 | 12 | 9.00 | 1.2 | 2250 | 34 |
| 004 | 24 | 18.00 | 2.4 | 4500 | 128 |

All figures are given for coil without pre-energization, at ambient temperature +23°C.

Coil versions, SMT, monostable

| Coil code | Rated voltage VDC | Operate voltage VDC _{min.} | Release voltage VDC _{min.} | Coil resistance Ω ±10% | Rated coil power mW |
|-----------|-------------------|-------------------------------------|-------------------------------------|------------------------|---------------------|
| 026 | 3 | 2.25 | 0.3 | 113 | 80 |
| 021 | 5 | 3.75 | 0.5 | 313 | 80 |
| 025 | 9 | 6.75 | 0.9 | 1015 | 80 |
| 022 | 12 | 9.00 | 1.2 | 1800 | 80 |
| 024 | 24 | 18.00 | 2.4 | 4500 | 128 |

All figures are given for coil without pre-energization, at ambient temperature +23°C.

Coil operative range, monostable DC coil

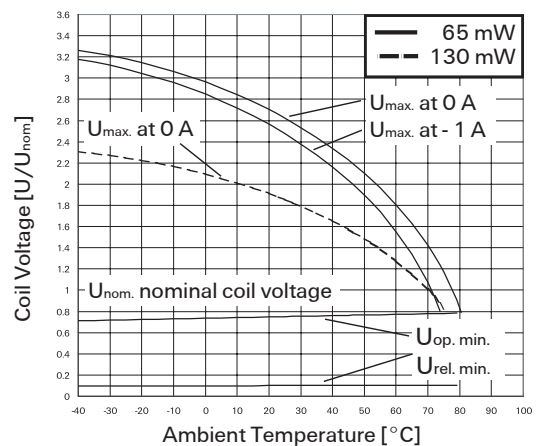

P1 Relay V23026 (Continued)

Coil data (continued)

Coil versions, THT and SMT, bistable 2 coils

| Coil code | Rated voltage VDC | Set voltage VDC | Reset voltage VDC | Coil resistance $\Omega \pm 10\%$ | Rated coil power mW |
|-----------|-------------------|-----------------|-------------------|-----------------------------------|---------------------|
| 106 | 3 | 2.25 | 2.25 | 130 | 69 |
| 101 | 5 | 3.75 | 3.75 | 390 | 64 |
| 105 | 9 | 6.75 | 6.75 | 1200 | 68 |
| 102 | 12 | 9.00 | 9.00 | 1500 | 96 |

All figures are given for coil without pre-energization, at ambient temperature +23°C. Coils I and II are identical.

¹⁾ A nominal voltage of 24VDC is feasible with a 12VDC coil with a series resistor (1500 Ω)

Coil data (continued)

Coil versions, THT, bistable 1 coil

| Coil code | Rated voltage VDC | Set voltage VDC | Reset voltage VDC | Coil resistance $\Omega \pm 10\%$ | Rated coil power mW |
|-----------|-------------------|-----------------|-------------------|-----------------------------------|---------------------|
| 056 | 3 | 2.25 | -2.25 | 300 | 30 |
| 051 | 5 | 3.75 | -3.75 | 740 | 34 |
| 057 | 9 | 6.75 | -6.75 | 2160 | 38 |
| 052 | 12 | 9.00 | -9.00 | 4500 | 32 |
| 054 | 24 | 18.00 | -18.00 | 4500 | 128 |

Coil data (continued)

Coil versions, SMT, bistable 1 coil

| Coil code | Rated voltage VDC | Set voltage VDC | Reset voltage VDC | Coil resistance $\Omega \pm 10\%$ | Rated coil power mW |
|-----------|-------------------|-----------------|-------------------|-----------------------------------|---------------------|
| 051 | 5 | 3.75 | -3.75 | 740 | 34 |
| 052 | 12 | 9.00 | -9.00 | 4500 | 32 |

A nominal voltage of 24V is feasible with a 12V coil with a series resistor (4500 Ω)

Other coil voltages on request

All figures are given for coil without pre-energization, at ambient temperature +23°C.

Coils I and II are identical.

Coil operative range, bistable

U_{max} upper limit of the operative range of the coil voltage (limiting voltage) when coils are

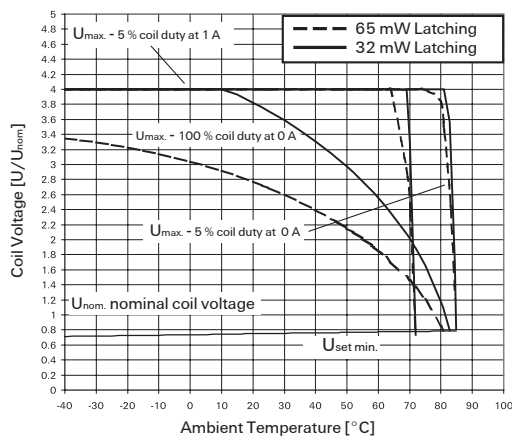

continuously energized.

$U_{op min}$ lower limit of the operative range of the coil voltage (reliable operate voltage).

$U_{rel min}$ lower limit of the operative range of the coil voltage (reliable release voltage).

Insulation Data

| | |
|---------------------------------|----------------------|
| Initial dielectric strength | |
| between open contacts | 500V _{rms} |
| between contact and coil | 1500V _{rms} |
| Initial surge withstand voltage | |
| between contact and coil | 2500V |
| Capacitance | |
| between open contacts | max. 5pF |
| between contact and coil | max. 6pF |
| Clearance/creepage | |
| between contact and coil | 0.75mm |
| between adjacent contacts | 0.75mm |

RF Data

| | |
|---|-----------------|
| Isolation at 100MHz/900MHz | -30.0dB/-18.0dB |
| Insertion loss at 100MHz/900MHz | -0.12dB/-1.9dB |
| Voltage standing wave ratio (VSWR) at 100MHz/900MHz | 1.06/1.75 |

Other Data

Material compliance: EU RoHS/ELV, China RoHS, REACH, Halogen content refer to the Product Compliance Support Center at www.te.com/customer-support/rohssupportcenter

| | |
|--|--|
| Ambient temperature | -40 to +85°C |
| Category of environmental protection, IEC 61810 | RT III - immersion cleanable |
| Vibration resistance (functional) | 20g, 200 to 2000Hz 40g, 10 to 200Hz |
| Shock resistance (functional) IEC 60068-2-27 (half sine) | 50 g |
| Terminal type | PCB terminals and SMT terminals |
| Weight | max. 2g |
| Resistance to soldering heat THT IEC 60068-2-20 | 265 °C/10s |
| Resistance to soldering heat SMT IEC 60068-2-58 | see reflow profile |
| Moisture sensitive level, JEDEC J-Std-020D | MSL3 |
| Washing | not recommended |
| Ultrasonic cleaning | possible |
| Packaging unit | |
| THT | 2000 pcs. |
| SMT | 2400 pcs. |

P1 Relay V23026 (Continued)

Dimensions

THT version

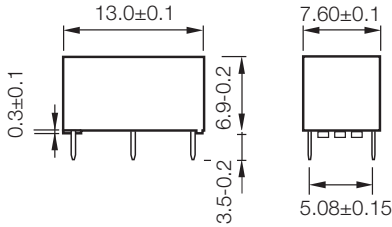

SMT version

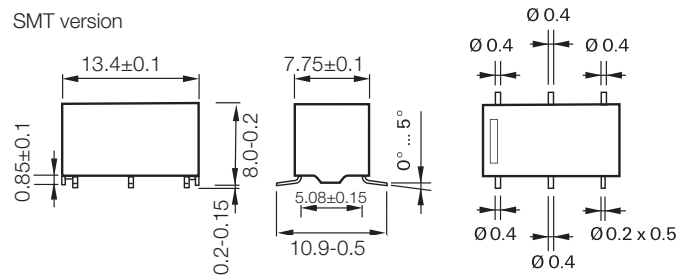

PCB layout

TOP view on component side of PCB

THT version

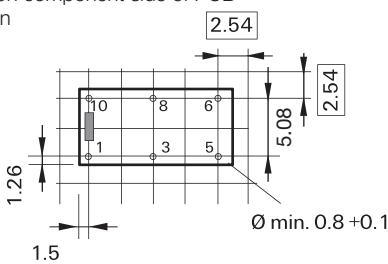

SMT version

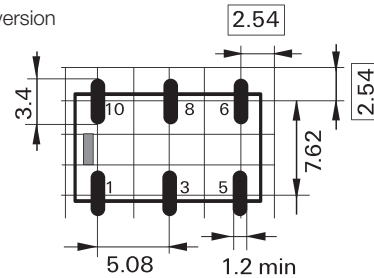

Terminal assignment

Monostable version
rest condition

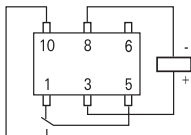

Bistable version, 1 coil
reset condition

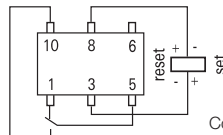

Bistable version, 2 coils
reset condition

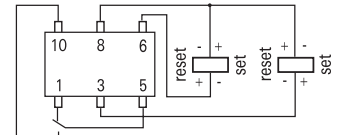

Contacts are shown in reset condition. Both coils can be used either as set or reset coil. Contact position might change during transportation and must be reset before use.

P1 Relay V23026 (Continued)

Processing

Recommended soldering conditions

Soldering conditions according IEC 60058-2-58 and IPC/JEDEC J-STD-020B

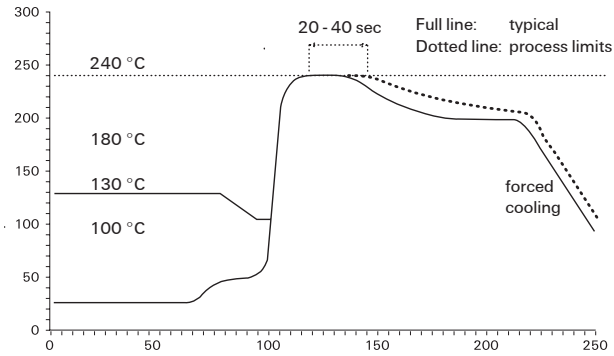

Resistance to soldering heat - Reflow profile
Vapor Phase Soldering: temperature/time profile (lead and housing peak temperature)

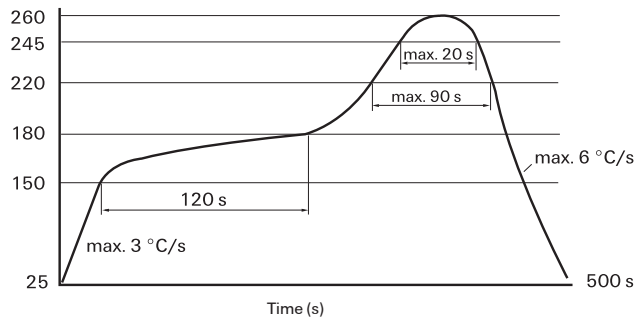

Infrared Soldering: temperature/time profile (lead and housing peak temperature)

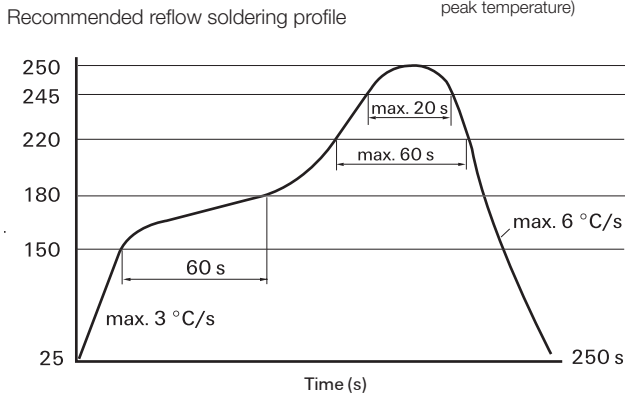

Packing

Tube for THT version
40 relays per tube, 2000 relays per box

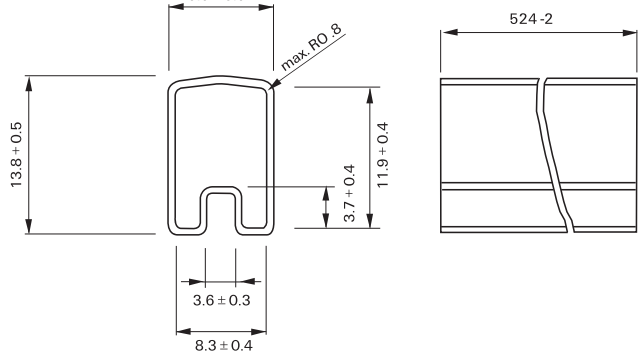

Tape and reel for SMT version
480 relays per reel, 2400 relays per box

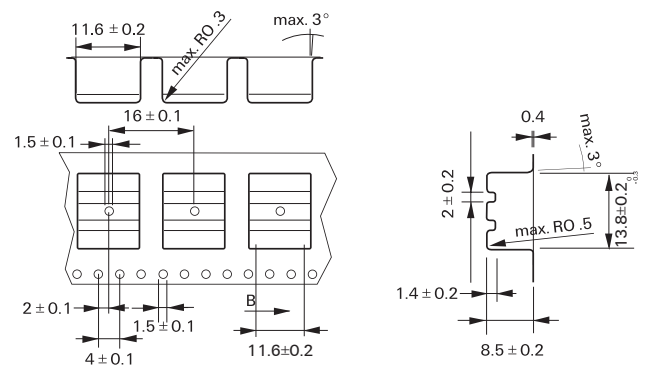

Reel dimensions

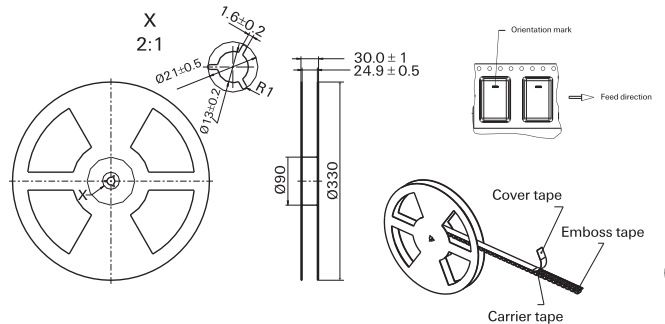

P1 Relay V23026 (Continued)

| | | | | | | |
|--|--|---|---------------|-----------|------------|-------------|
| Product code structure | | Typical product code | V23026 | A1 | 002 | B201 |
| Type | | | | | | |
| V23026 P1 Series Signal Relay | | | | | | |
| Version | | | | | | |
| A1 THT, monostable | | D1 SMT, monostable | | | | |
| B1 THT, bistable (latching), 2 coils | | E1 SMT, bistable (latching), 2 coils | | | | |
| C1 THT, bistable (latching), 1 coil | | F1 SMT, bistable (latching), 1 coil | | | | |
| Coil | | | | | | |
| Coil code: please refer to coil versions table | | | | | | |
| Contacts | | | | | | |
| B201 1 form C, 1 CO | | | | | | |

| Product Code | Version | Coil | Coil voltage | Part Number |
|-----------------|-------------------|-------------|-------------------|-------------|
| V23026A1006B201 | THT version | monostable | 3VDC | 1-1393774-7 |
| V23026A1001B201 | | | 5VDC | 1393774-1 |
| V23026A1005B201 | | | 9VDC | 1-1393774-5 |
| V23026A1002B201 | | | 12VDC | 1393774-8 |
| V23026A1004B201 | | | 24VDC | 1-1393774-2 |
| V23026B1106B201 | | | bistable, 2 coils | 3VDC |
| V23026B1101B201 | | 5VDC | | 3-1393774-4 |
| V23026B1105B201 | | 9VDC | | 1393775-2 |
| V23026B1102B201 | | 12VDC | | 3-1393774-5 |
| V23026C1056B201 | | 3VDC | | 2-1393774-6 |
| V23026C1051B201 | | 5VDC | | 2-1393774-0 |
| V23026C1057B201 | | SMT version | monostable | 9VDC |
| V23026C1052B201 | 12VDC | | | 2-1393774-1 |
| V23026C1054B201 | 24VDC | | | 2-1393774-4 |
| V23026D1026B201 | 3VDC | | | 1393776-8 |
| V23026D1021B201 | 5VDC | | | 1393776-3 |
| V23026D1025B201 | 9VDC | | | 1422015-9 |
| V23026D1022B201 | 12VDC | | 1393776-4 | |
| V23026D1024B201 | 24VDC | | 1393776-7 | |
| V23026E1106B201 | bistable, 2 coils | | 3VDC | 1393777-3 |
| V23026E1101B201 | | | 5VDC | 1422015-6 |
| V23026E1105B201 | | | 9VDC | 1393777-2 |
| V23026E1102B201 | | | 12VDC | 1393776-9 |
| V23026F1051B201 | | 9VDC | 1422015-8 | |
| V23026F1052B201 | | 12VDC | 4-1393774-3 | |

Компания «Океан Электроники» предлагает заключение долгосрочных отношений при поставках импортных электронных компонентов на взаимовыгодных условиях!

Наши преимущества:

- Поставка оригинальных импортных электронных компонентов напрямую с производств Америки, Европы и Азии, а так же с крупнейших складов мира;
- Широкая линейка поставок активных и пассивных импортных электронных компонентов (более 30 млн. наименований);
- Поставка сложных, дефицитных, либо снятых с производства позиций;
- Оперативные сроки поставки под заказ (от 5 рабочих дней);
- Экспресс доставка в любую точку России;
- Помощь Конструкторского Отдела и консультации квалифицированных инженеров;
- Техническая поддержка проекта, помощь в подборе аналогов, поставка прототипов;
- Поставка электронных компонентов под контролем ВП;
- Система менеджмента качества сертифицирована по Международному стандарту ISO 9001;
- При необходимости вся продукция военного и аэрокосмического назначения проходит испытания и сертификацию в лаборатории (по согласованию с заказчиком);
- Поставка специализированных компонентов военного и аэрокосмического уровня качества (Xilinx, Altera, Analog Devices, Intersil, Interpoint, Microsemi, Actel, Aeroflex, Peregrine, VPT, Syfer, Eurofarad, Texas Instruments, MS Kennedy, Miteq, Cobham, E2V, MA-COM, Hittite, Mini-Circuits, General Dynamics и др.);

Компания «Океан Электроники» является официальным дистрибьютором и эксклюзивным представителем в России одного из крупнейших производителей разъемов военного и аэрокосмического назначения «JONHON», а так же официальным дистрибьютором и эксклюзивным представителем в России производителя высокотехнологичных и надежных решений для передачи СВЧ сигналов «FORSTAR».



JONHON

«JONHON» (основан в 1970 г.)

Разъемы специального, военного и аэрокосмического назначения:

(Применяются в военной, авиационной, аэрокосмической, морской, железнодорожной, горно- и нефтедобывающей отраслях промышленности)

«FORSTAR» (основан в 1998 г.)

ВЧ соединители, коаксиальные кабели, кабельные сборки и микроволновые компоненты:

(Применяются в телекоммуникациях гражданского и специального назначения, в средствах связи, РЛС, а так же военной, авиационной и аэрокосмической отраслях промышленности).



Телефон: 8 (812) 309-75-97 (многоканальный)

Факс: 8 (812) 320-03-32

Электронная почта: ocean@oceanchips.ru

Web: <http://oceanchips.ru/>

Адрес: 198099, г. Санкт-Петербург, ул. Калинина, д. 2, корп. 4, лит. А