

Pressure Sensor PS-A



Pressure sensor
Built-in amplifier and compensating circuit

Features

- Built-in amplifier and temperature compensation circuit, no need for circuit design and characteristic adjustment
- High accuracy and reliability : overall accuracy $\pm 1.25\%$ FS (Standard), $\pm 2.5\%$ FS (Low-pressure type)
- Compact size, space-saving : compatible size for PS type (Standard/Economy, S and M packages)
- RoHS compliant

Typical Applications

- Industrial use : pressure switches and pneumatic components, compressed air pressure measuring devices
- Medical use : blood pressure meters, oxygen generator and airbeds
- Others : pressure sensing devices for air pressure mediums

Low-pressure type

- Water level detection for domestic appliances: washing machines and dishwashers
- Air pressure control : cleanrooms and smoking rooms
- Medical applications : breathing pressure measuring devices

Ordering Information

ADP5



Product Types

Package (Pressure inlet hole length)	Part No.								
	Standard type		Standard/Economy type		Low pressure type				
	S Package (3 mm 0.118 inch)		M Package (5 mm 0.118 inch)		M Package (5 mm 0.197 inch)	L Package (13.5 mm 0.531 inch)	P Package (15.6 mm 0.614 inch)		
Terminal	DIP terminal	SMD terminal	DIP terminal	SMD terminal	DIP terminal	DIP terminal	DIP terminal	DIP terminal	DIP terminal
Standard type (with glass base)	± 100 kPa	ADP5100	ADP5200	ADP5101	ADP5201	—	—	—	—
	-100 kPa	ADP5110	ADP5210	ADP5111	ADP5211	—	—	—	—
	25 kPa	ADP5120	—	ADP5121	—	—	—	—	—
	50 kPa	ADP5130	—	ADP5131	—	—	—	—	—
	100 kPa	ADP5140	ADP5240	ADP5141	ADP5241	—	—	—	—
	200 kPa	ADP5150	ADP5250	ADP5151	ADP5251	—	—	—	—
	500 kPa	ADP5160	ADP5260	ADP5161	ADP5261	—	—	—	—
1,000 kPa	ADP5170	ADP5270	ADP5171	ADP5271	—	—	—	—	
Economy type (without glass base)	40 kPa	—	—	ADP51A11	—	—	—	—	—
Low pressure type	6 kPa	—	—	—	—	ADP51B61	ADP51B62	ADP51B63	—

Standard packing : Carton : 100 pcs.; Case : 1,000 pcs.

Rating

● Standard type

Item	Standard type (with glass base)								Remarks
Type of pressure	Gauge pressure								
Pressure medium	Air								*1
Rated pressure (kPa)	±100	-100	25	50	100	200	500	1,000	
Max. applied pressure	Twice of the rated pressure								1.5 times the rated pressure
Ambient temperature	-10 °C to +60 °C 14 °F to +140 °F (no freezing or condensation)								
Storage temperature	-20 °C to +85 °C -4 °F to +185 °F (no freezing or condensation)								
Drive voltage	5±0.25 V.DC								
Temperature compensation range	0 °C to 50 °C 32 °F to 122 °F								
Offset voltage	2.5±0.05	0.5±0.05 V							*2, 3, 5
Rated output voltage	4.5±0.05 (+when +100kPa)	4.5±0.05 V							*2, 3, 5
Overall accuracy	±1.25 %FS								*3, 4, 5
Current consumption	Max. 10 mA								*2, 3
Output impedance	15 Ω (Typical)								*2
Source current	Max. 0.2 mA								*2, 3
Sink current	Max. 2 mA								*2, 3

Notes : *1 Please consult us for pressure media other than air.
 *2 Indicates output when temperature is 25 °C 77 °F.
 *3 Indicates output when drive voltage is 5 V. Although output fluctuates due to fluctuations in the drive voltage, this is not included.
 *4 Overall accuracy indicates the accuracy of the offset voltage and rated output voltage at a temperature compensation range of 0 to 50 °C 32 to 122 °F.
 *5 Accuracy is the value at the time of our shipping. Please set Zero-point calibration function on your products in order to safely use if the offset voltage is shifted.

● Economy type

Item	Economy type (without glass base)								Remarks
Type of pressure	Gauge pressure								
Pressure medium	Air								*1
Rated pressure (kPa)	40								
Max. applied pressure	Twice of the rated pressure								
Ambient temperature	-5 °C to +50 °C 23 °F to +122 °F (no freezing or condensation)								
Storage temperature	-20 °C to +70 °C -4 °F to +158 °F (no freezing or condensation)								
Drive voltage	3±0.15 V.DC								
Temperature compensation range	5 °C to 45 °C 41 °F to 113 °F								
Offset voltage	0.3±0.09 V								*2, 3, 5
Span voltage	2.4±0.03 V								*2, 3, 5
Offset voltage temperature characteristics	±4.0 %FS								*3, 4, 5
Sensitivity temperature characteristics	1.3 %FS								*3, 4, 5
Current consumption	Max. 3 mA								*2
Output impedance	20 Ω (Typical)								*2, 3
Source current	Max. 0.15 mA								*2, 3
Sink current	Max. 1.5 mA								*2, 3

Notes : *1 Please consult us for pressure media other than air.
 *2 Indicates output when temperature is 25 °C 77 °F.
 *3 Indicates output when drive voltage is 3 V. Although output fluctuates due to fluctuations in the drive voltage, this is not included.
 *4 Indicates from output value at 25 °C 77 °F and the change of output at 5 and 45 °C 41 to 113 °F.
 *5 Accuracy is the value at the time of our shipping. Please set Zero-point calibration function on your products in order to safely use if the offset voltage is shifted.

● Low pressure type

Item	Economy type (without glass base)	Remarks
Type of pressure	Gauge pressure	
Pressure medium	Air	*1
Rated pressure (kPa)	6	
Max. applied pressure	Twice of the rated pressure	
Ambient temperature	0 °C to +70 °C 32 °F to +158 °F (no freezing or condensation)	
Storage temperature	-30 °C to +100 °C -22 °F to +212 °F (no freezing or condensation)	
Drive voltage	5±0.25 V.DC	
Temperature compensation range	0 °C to 70 °C 32 °F to 158 °F	
Offset voltage	0.5 V (Typical)	*2
Span voltage	4.0 V (Typical)	*2
Overall accuracy	±2.5 %FS	*2, 3, 4
Current consumption	Max. 10 mA	
Output impedance	50 Ω (Typical)	
Source current	Max. 0.2 mA	
Sink current	Max. 2.0 mA	

Notes : *1 Please consult us for pressure media other than air.

*2 Indicates output when drive voltage is 5 V. Although output fluctuates due to fluctuations in the drive voltage, this is not included.

*3 Overall accuracy indicates the accuracy of the offset voltage and span voltage at temperatures between 0 to 70 °C 32 to 158 °F (FS=4V)

*4 The initial offset voltage error is not included in the overall accuracy.

Reference Data

● Standard type

1.-(1) Output voltage

ADP5170
Drive voltage : 5 V.DC
Temperature : 25 °C 77 °F
Applied pressure : 0 to +1,000 kPa

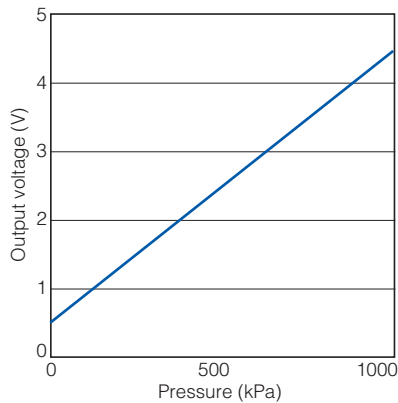

1.-(2) Overall accuracy (Offset voltage)

ADP5170
Drive voltage : 5 V.DC
Temperature : 0 to 50 °C 32 to 122 °F
Applied pressure : 0 kPa

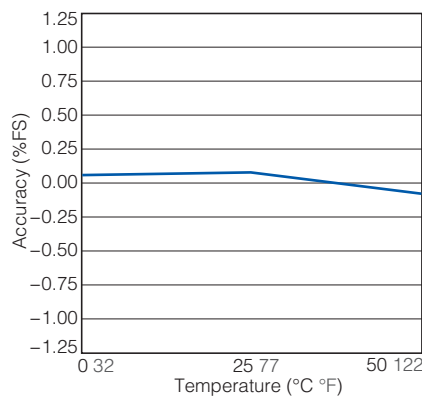

1.-(3) Overall accuracy (Rated output voltage)

ADP5170
Drive voltage : 5 V.DC
Temperature : 0 to 50 °C 32 to 122 °F
Applied pressure : +1,000 kPa

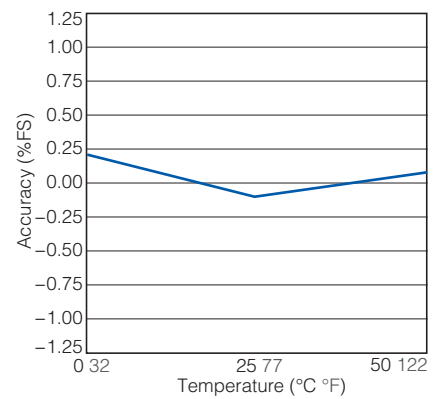

2.-(1) Output voltage

ADP5100
Drive voltage : 5 V.DC
Temperature : 25 °C 77 °F
Applied pressure : -100 to +100 kPa

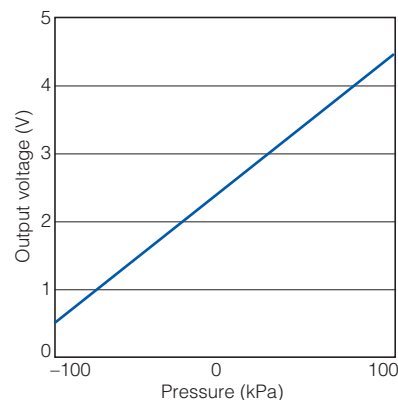

2.-(2) Overall accuracy (Offset voltage)

ADP5100
Drive voltage : 5 V.DC
Temperature : 0 to 50 °C 32 to 122 °F
Applied pressure : 0 kPa

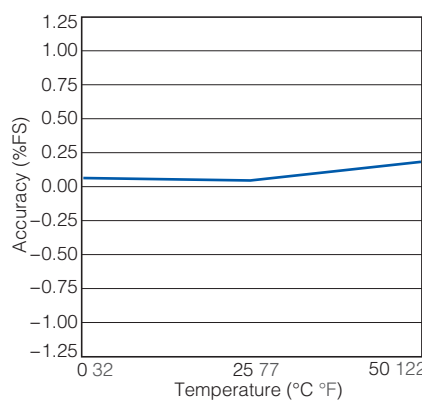

2.-(3) Overall accuracy (Rated output voltage)

ADP5100
Drive voltage : 5 V.DC
Temperature : 0 to 50 °C 32 to 122 °F
Applied pressure : +100 kPa

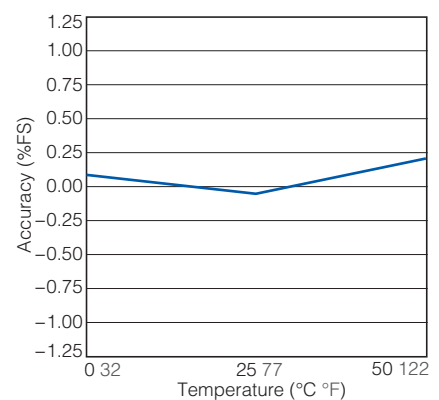

● Low pressure type

1 Output voltage

ADP51B61
 Drive voltage : 5 V.DC
 Temperature : 25 °C 77 °F
 Applied pressure : 0 to 6 kPa



2 THB (high temperature high humidity bias test)

ADP51B61
 Within 85 °C 185 °F and 85% RH
 5 V applied between No.2 (Vdd) and No.3 (GND)
 Applied pressure : 0 kPa

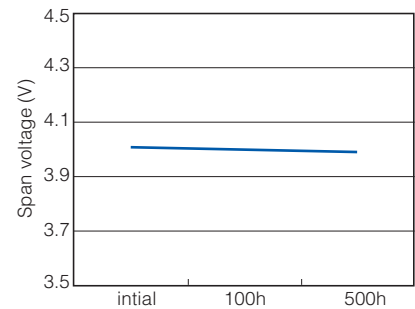
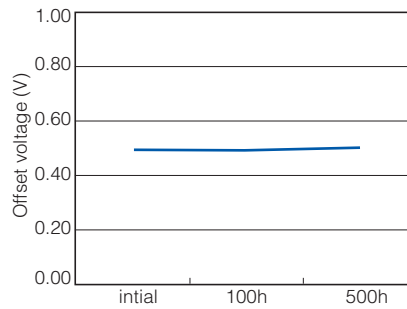

3 Ambient temperature characteristics

Ambient temperature : 25 °C 77 °F → 0 °C 32 °F → 10 °C 50 °F → 60 °C 140 °F → 70 °C 158 °F



4 Shock test

ADP51B61
 Shock applied : 981 m/s², 3 times in x, y and z directions
 Applied pressure : 0 kPa

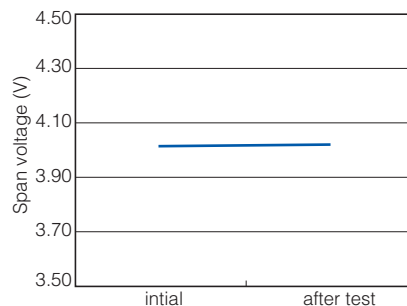
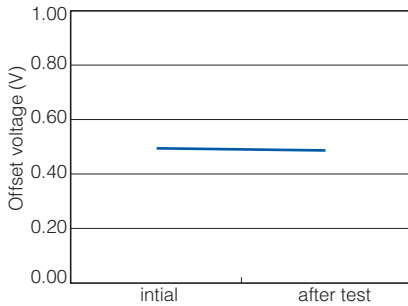

5 Vibration test

ADP51B61
 Vibration applied : 10 to 55 Hz, amplitude : 1.5mm, x, y and z directions, 2 hrs each
 Applied pressure : 0 kPa



6 Temperature/humidity cycle test
 ADP51B61
 Exposed to 10 cycles in the temperature and humidity conditions given below.
 Applied pressure : 0kPa

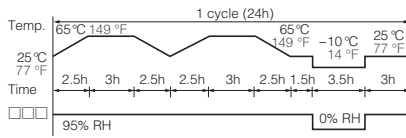

Evaluation Test

Classification	Tested item	Tested condition	Result
Environmental characteristics	Storage at high temperature	Temperature : Left in a 85 °C 185 °F constant temperature bath; Time : 100 hrs.	Passed
	Storage at low temperature	Temperature : Left in a -20 °C -4 °F constant temperature bath; Time : 100 hrs.	Passed
	Humidity resistance	Temperature/humidity : Left at 40 °C 104 °F, 90 % RH; Time : 100 hrs.	Passed
	Temperature cycle	Temperature : -20 °C to 85 °C -4 °F to 185 °F; 1 cycle : 30 min.; Times of cycle : 100	Passed
Endurance characteristics	High temperature/ high humidity operation	Temperature/humidity : 40 °C 104 °F, 90% RH; Operation times : 10 ⁶ , rated voltage applied	Passed
Mechanical characteristics	Vibration resistance	Double amplitude : 1.5 mm 0.059 inch; Vibration : 10 to 55 Hz; Applied vibration direction : X, Y, Z 3 directions; Times : 2 hrs each	Passed
	Dropping resistance	Dropping height : 75 cm 29.528 inch; Times : 2 times	Passed
	Terminal strength	Pulling strength : 9.8 N {1 kgf}, 10 sec.; Bending strength : 4.9 N {0.5 kgf}, left and right 90 ° 1 time	Passed
Soldering Characteristics	Solderability	Temperature : 230 °C 446 °F; Time : 5 sec.	Passed
	Heat resistance (DIP)	Temperature : 260 °C 500 °F; Time : 10 sec.	Passed

Items	Criteria
Offset voltage Rated Output Voltage	Variation amount within $\pm 2.5\%$ FS of value

Dimensions

The CAD data of the products with a **CAD Data** mark can be downloaded from: <http://industrial.panasonic.com/>

- Standard type S Package (Terminal direction : DIP terminal Pressure inlet hole length : 3 mm 0.118 inch)
ADP51□□

CAD Data



Recommended PC board pattern



Terminal connection diagram

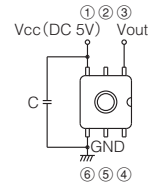

unit : mm inch
General tolerance : ±0.3 ±0.012

Terminal No.	Name
1	Vcc (Power supply [+])
2	NU (Not usable)
3	Vout (Output)
4	NU (Not usable)
5	NU (Not usable)
6	GND (Ground)

- Standard type S Package (Terminal direction : SMD terminal Pressure inlet hole length : 3 mm 0.118 inch)
ADP52□□

CAD Data

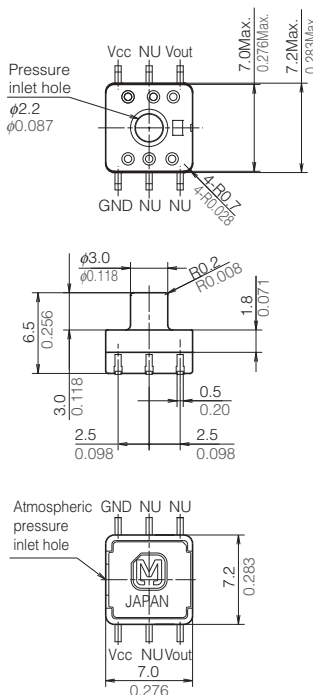

Recommended PC board pattern

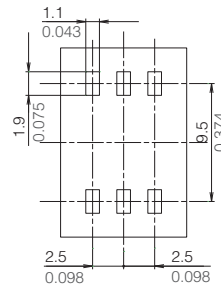

Terminal connection diagram

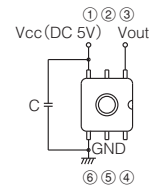

unit : mm inch
General tolerance : ±0.3 ±0.012

Terminal No.	Name
1	Vcc (Power supply [+])
2	NU (Not usable)
3	Vout (Output)
4	NU (Not usable)
5	NU (Not usable)
6	GND (Ground)

Dimensions

The CAD data of the products with a **CAD Data** mark can be downloaded from: <http://industrial.panasonic.com/>

- Standard/Economy type M Package (Terminal direction : DIP terminal Pressure inlet hole length : 5 mm 0.197 inch)
ADP51□1/ADP51A11

CAD Data

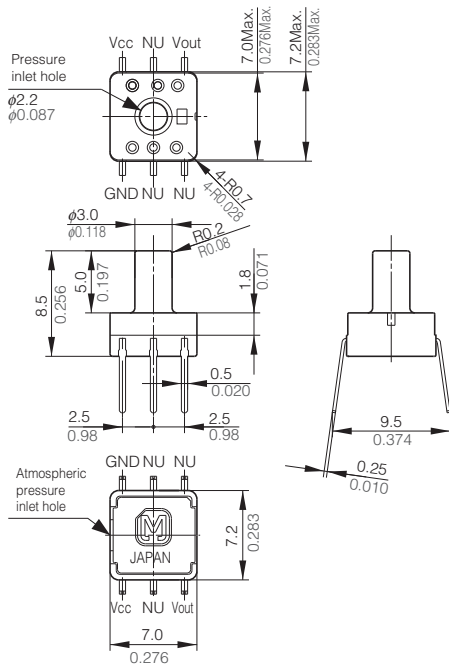

Recommended PC board pattern

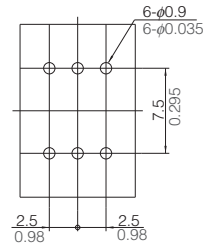

Terminal connection diagram

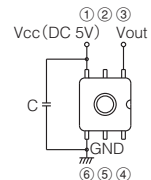

unit : mm inch
General tolerance : $\pm 0.3 \pm 0.012$

Terminal No.	Name
1	Vcc (Power supply [+])
2	NU (Not usable)
3	Vout (Output)
4	NU (Not usable)
5	NU (Not usable)
6	GND (Ground)

- Standard type M Package (Terminal direction : SMD terminal Pressure inlet hole length : 5 mm 0.197 inch)
ADP52□1

CAD Data

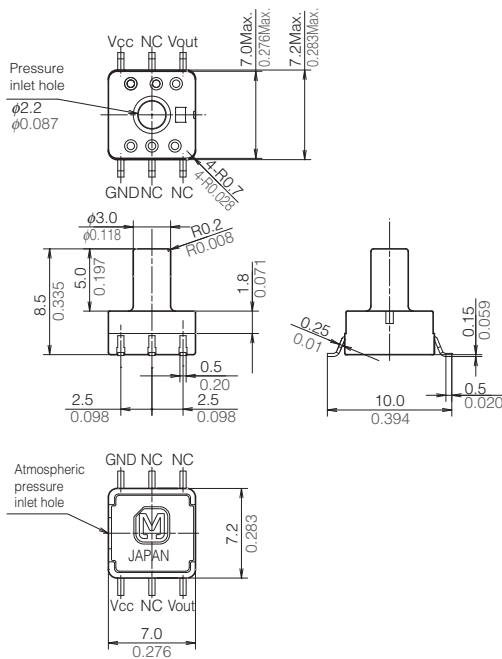

Recommended PC board pattern

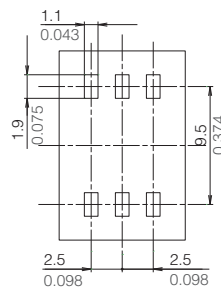

Terminal connection diagram

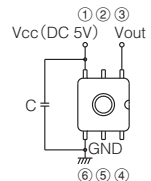

unit : mm inch
General tolerance : $\pm 0.3 \pm 0.012$

Terminal No.	Name
1	Vcc (Power supply [+])
2	NU (Not usable)
3	Vout (Output)
4	NU (Not usable)
5	NU (Not usable)
6	GND (Ground)

Dimensions

The CAD data of the products with a **CAD Data** mark can be downloaded from: <http://industrial.panasonic.com/>

- Low pressure type M Package (Terminal direction : DIP terminal, Pressure inlet hole length : 5 mm 0.197 inch) ADP51B61

CAD Data



Recommended PC board pattern (BOTTOM VIEW)

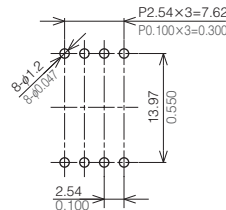

Terminal connection diagram

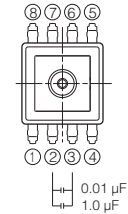

unit : mm inch
General tolerance : ±0.3 ±0.012

Terminal No.	Name	Terminal No.	Name
1	NU (Not usable)	5	NU (Not usable)
2	Vcc (Power supply [+])	6	NU (Not usable)
3	GND (Ground)	7	NU (Not usable)
4	Vout (Output)	8	NU (Not usable)

- Low pressure type L Package (Terminal direction : DIP terminal, Pressure inlet hole length : 13.5 mm 0.531 inch) ADP51B62

CAD Data

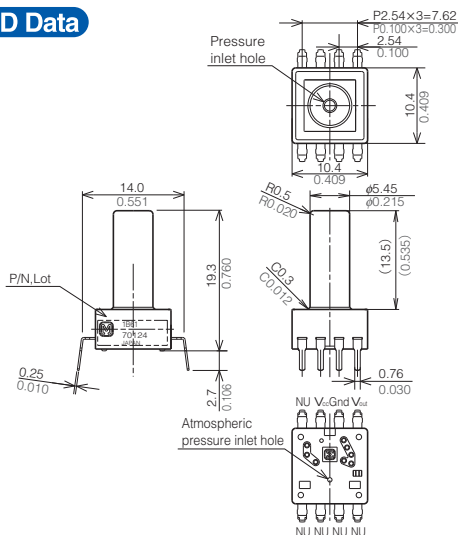

Recommended PC board pattern (BOTTOM VIEW)

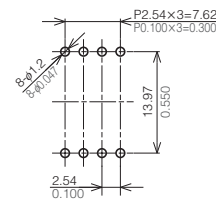

Terminal connection diagram

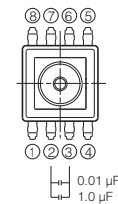

unit : mm inch
General tolerance : ±0.3 ±0.012

Terminal No.	Name	Terminal No.	Name
1	NU (Not usable)	5	NU (Not usable)
2	Vcc (Power supply [+])	6	NU (Not usable)
3	GND (Ground)	7	NU (Not usable)
4	Vout (Output)	8	NU (Not usable)

- Low pressure type P Package (Terminal direction : DIP terminal, Pressure inlet hole length : 15.6 mm 0.614 inch) ADP51B63

CAD Data

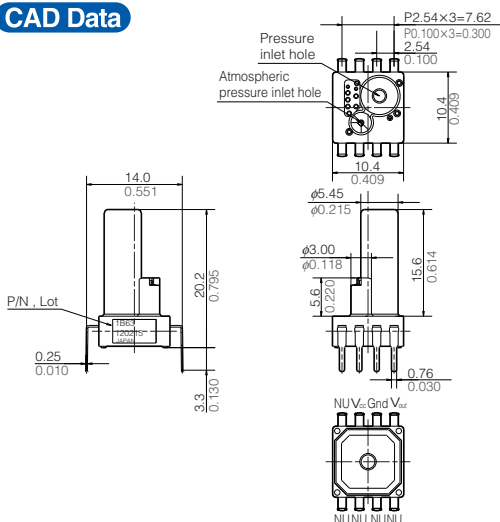

Recommended PC board pattern (BOTTOM VIEW)

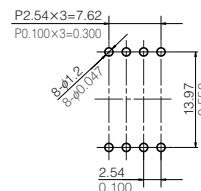

Terminal connection diagram

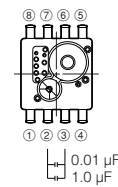

unit : mm inch
General tolerance : ±0.3 ±0.012

Terminal No.	Name	Terminal No.	Name
1	NU (Not usable)	5	NU (Not usable)
2	Vcc (Power supply [+])	6	NU (Not usable)
3	GND (Ground)	7	NU (Not usable)
4	Vout (Output)	8	NU (Not usable)

NOTES

■ Mounting

Use the land of the printed-circuit board on which the sensor is securely fixed.

■ Soldering

Avoid the external thermal influence as the product has a limited thermal capacity due to its compact structure. Heat deformation may damage the sensor or deteriorate its performance. Use the non-corrosive rosin flux. Prevent the flux from entering into the inside of the product as the sensor is exposed to the atmosphere.

- 1) Manual soldering
 - Raise the temperature of the soldering tip between 260 and 300 °C 500 and 572 °F (30 W) and solder within 5 seconds.
 - The sensor output may vary if the load is applied on the terminal during soldering.
 - Keep the soldering tip clean.
- 2) DIP soldering (DIP Terminal)
 - Keep the temperature of the DIP solder tank below 260 °C 572 °F and solder within 5 seconds.
 - To avoid heat deformation, do not perform DIP soldering when mounting on the circuit board which has a small thermal capacity.
- 3) Reflow soldering (SMD Terminal)
 - The recommended reflow temperature profile conditions are given below.

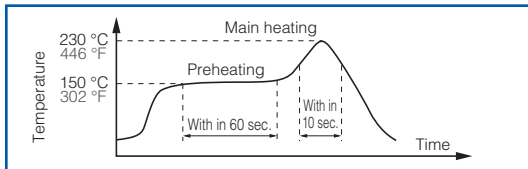

- We recommend the screen solder printing method as the method of cream.
 - Please refer to the recommended PC board specification diagram for the PC board foot pattern.
 - Self alignment may not always work as expected, therefore, please carefully the position of the terminals and pattern.
 - The temperature of the profile is assumed to be a value measured with the printed wiring board of the terminal neighborhood.
 - Please evaluate solderability under the actual mounting conditions since welding and deformation of the pressure inlet port may occur due to heat stress depending on equipments or conditions.
- 4) Rework soldering
 - Complete rework at a time.
 - Use a flattened soldering tip when performing rework on the solder bridge. Do not add the flux.
 - Keep the soldering tip below the temperature described in the specifications.
 - 5) Avoid drop and rough handling as excessive force may deform the terminal and damage soldering characteristics.
 - 6) Keep the circuit board warpage within 0.05 mm of the full width of the sensor.
 - 7) After soldering, do not apply stress on the soldered part when cutting or bending the circuit board.
 - 8) Prevent human hands or metal pieces from contacting with the sensor terminal. Such contact may cause anomalous outlets as the terminal is exposed to the atmosphere.
 - 9) After soldering, prevent chemical agents from adhering to the sensor when applying coating to avoid insulation deterioration of the circuit board.
 - 10) Please consult us concerning leadfree soldering.

■ Wire connection

- 1) Correctly wire as in the connection diagram. Reverse connection may damage the product and degrade the performance.
- 2) Do not use idle terminals to prevent damages to the sensor.

■ Cleaning

- Prevent cleaning liquid from entering the inside of the product as the sensor is exposed to the atmosphere.
- Do not perform ultrasonic cleaning in order to prevent damages to the product.

■ Environment

- 1) Avoid use and storage in the corrosive gas (organic solvent, sulfurous acid and hydrogen sulfide gases) which negatively affects the product.
- 2) Install the capacitor on the power supply terminal of the sensor and stabilize supply voltage to maintain a superimposed noise resistance. Recommended installation is to arrange 0.1 μF and 1,000 pF in parallel. Before use, check the noise resistance and select/add the optimal capacitor.
- 3) Use surge absorbers as applying the external surge voltage may damage the internal circuit.
- 4) Malfunction may occur near electric noises from static electricity, lightning, broadcast or amateur radio stations and mobile phones.
- 5) Avoid use in a place where these products come in contact with water as the sensor does not have a splash-proof construction.
- 6) Avoid use in an environment where these products cause dew condensation. When water attached to the sensor chip freezes, the sensor output may be fluctuated or damaged.
- 7) Due to the structure of the pressure sensor chip, the output varies under light. Do not expose the sensor chip to light when applying a voltage by using a transparent tube.
- 8) Do not apply high-frequency oscillation, such as ultrasonic waves, to the product.

■ Quality check under actual use conditions

These specifications are for individual components. Before use, carefully check the performance and quality under actual use conditions to enhance stability.

■ Other precautions

- 1) The wrong mounting method and the pressure range may invite the risk of accidents.
- 2) Only applicable pressure medium is dry air. Avoid use in the corrosive gas (organic solvent, sulfurous acid and hydrogen sulfide gases) or other mediums containing moisture or foreign substances. Such mediums may damage or break the product.
- 3) The pressure sensor chip is located inside the pressure introduction port. Do not insert foreign substances, such as wires, into the port as those substances may damage the chip and close the port. Do not block the atmosphere introduction port.
- 4) Use electric power within the rated power range. Use beyond the range may damage the product.
- 5) Follow below instructions as static electricity may damage the product:
 - (1) For Storage, short the circuit between terminals by using conductive substances or wrap the whole chip with aluminum foil. For storage and transportation, avoid plastic containers which are easily electrified.
 - (2) Before use, connect electrified materials on desk and operators to the ground in order to safely discharge static electricity.
- 6) Carefully select and fix tubes, introduction pipes and products based on the working voltage. Please contact us for any inquires.
- 7) After mounding the pressure sensor, prevent the potting agent from entering the pressure and the atmosphere introduction ports when coating the circuit board. Use the elastic resin as the heated resin may expand, contract and apply pressure to the sensor. After coating, carefully check if the sensor can be used.

Safety precautions

Accidents occur at certain probability for Electronic components and equipment in spite that we keep working on a improvement in quality and reliability. In order that accidents result in injury or death, fire accidents and social damages do not occur, please pay enough attention to safety design such as redundancy design, fire spread preventing design and malfunction preventing design etc.

Our quality standards fall into the following three categories depending on the applications of the products: Reference Standards, Special Standards, and Specified Standards that meet the quality assurance program designated by the customer. These quality standards have been established so that our products will be used for the applications listed below.

Reference Standards: Computers, office automation equipment, communications equipment, audio-video products, home electrical appliances, machine tools, personal devices, industrial robots

Special Standards: Transportation equipment (automobiles, trains, ships, etc.), traffic signal equipment, crime and disaster prevention devices, electric power equipment, various safety devices, and medical equipment not directly targeted for life support

Specified Standards: Aircraft equipment, aeronautical and space equipment, seabed relay equipment, nuclear power control systems, and medical equipment, devices and systems for life support

Before considering the use of our products under the following conditions, you must contact one of our customer service representatives without fail and exchange written specifications.

- (1) When our products are to be used in any of the applications listed for the Special Standards or Specified Standards
- (2) When, even for any of the applications listed for the Reference Standards, our products may possibly be used beyond the range of the specifications, environment or conditions listed in the document or when you are considering the use of our products in any conditions or an environment that is not listed in the document

Mouser Electronics

Authorized Distributor

Click to View Pricing, Inventory, Delivery & Lifecycle Information:

Panasonic:

[ADP51B62A01](#) [ADP5120](#) [ADP5260](#) [ADP5211](#) [ADP5171](#) [ADP5200](#) [ADP5150](#) [ADP5100](#) [ADP5101](#) [ADP51B61](#)
[ADP5220](#) [ADP5270](#) [ADP5130](#) [ADP5210](#) [ADP5231](#) [ADP5140](#) [ADP5131](#) [ADP5141](#) [ADP5261](#) [ADP5230](#) [ADP5151](#)
[ADP5160](#) [ADP5240](#) [ADP5221](#) [ADP5170](#) [ADP5251](#) [ADP5241](#) [ADP5110](#) [ADP5121](#) [ADP5271](#) [ADP51B62](#)
[ADP5111](#) [ADP5201](#) [ADP5161](#) [ADP5250](#) [ADP51A11](#) [ADP51B63](#)

Компания «Океан Электроники» предлагает заключение долгосрочных отношений при поставках импортных электронных компонентов на взаимовыгодных условиях!

Наши преимущества:

- Поставка оригинальных импортных электронных компонентов напрямую с производств Америки, Европы и Азии, а так же с крупнейших складов мира;
- Широкая линейка поставок активных и пассивных импортных электронных компонентов (более 30 млн. наименований);
- Поставка сложных, дефицитных, либо снятых с производства позиций;
- Оперативные сроки поставки под заказ (от 5 рабочих дней);
- Экспресс доставка в любую точку России;
- Помощь Конструкторского Отдела и консультации квалифицированных инженеров;
- Техническая поддержка проекта, помощь в подборе аналогов, поставка прототипов;
- Поставка электронных компонентов под контролем ВП;
- Система менеджмента качества сертифицирована по Международному стандарту ISO 9001;
- При необходимости вся продукция военного и аэрокосмического назначения проходит испытания и сертификацию в лаборатории (по согласованию с заказчиком);
- Поставка специализированных компонентов военного и аэрокосмического уровня качества (Xilinx, Altera, Analog Devices, Intersil, Interpoint, Microsemi, Actel, Aeroflex, Peregrine, VPT, Syfer, Eurofarad, Texas Instruments, MS Kennedy, Miteq, Cobham, E2V, MA-COM, Hittite, Mini-Circuits, General Dynamics и др.);

Компания «Океан Электроники» является официальным дистрибьютором и эксклюзивным представителем в России одного из крупнейших производителей разъемов военного и аэрокосмического назначения «JONHON», а так же официальным дистрибьютором и эксклюзивным представителем в России производителя высокотехнологичных и надежных решений для передачи СВЧ сигналов «FORSTAR».



JONHON

«JONHON» (основан в 1970 г.)

Разъемы специального, военного и аэрокосмического назначения:

(Применяются в военной, авиационной, аэрокосмической, морской, железнодорожной, горно- и нефтедобывающей отраслях промышленности)

«FORSTAR» (основан в 1998 г.)

ВЧ соединители, коаксиальные кабели,
кабельные сборки и микроволновые компоненты:

(Применяются в телекоммуникациях гражданского и специального назначения, в средствах связи, РЛС, а так же военной, авиационной и аэрокосмической отраслях промышленности).



Телефон: 8 (812) 309-75-97 (многоканальный)

Факс: 8 (812) 320-03-32

Электронная почта: ocean@oceanchips.ru

Web: <http://oceanchips.ru/>

Адрес: 198099, г. Санкт-Петербург, ул. Калинина, д. 2, корп. 4, лит. А