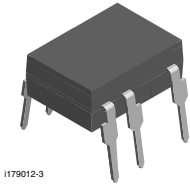
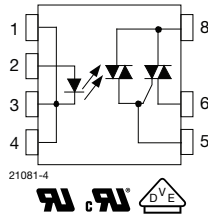


Optocoupler, Power Phototriac



1179012-3



FEATURES

- Maximum trigger current (I_{FT}): 10 mA
- Isolation test voltage 5300 V_{RMS}
- Peak off-state voltage 600 V
- Load current 1 A_{RMS}
- dV/dt of 210 V/ μs
- DIP-8 package
- Pure tin leads
- Material categorization: For definitions of compliance please see www.vishay.com/doc?99912


RoHS
COMPLIANT

PIN	FUNCTION
1	LED cathode
2	LED anode
3	LED cathode
4	LED cathode
5	Triac gate
6	Triac T1
7	Triac T2

APPLICATIONS

- Home appliances (air conditioners, microwave ovens, washing machines, personal hygiene systems, refrigerators, fan heaters, inductive heating cooker, water heaters, etc.)
- Industrial equipments

AGENCY APPROVALS

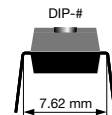
- UL - E52744 system code H
- cUL - E52744 system code H
- VDE - DIN EN60747-5-5 (VDE 0884-5)

DESCRIPTION

The VO2223A is an optically couple phototriac driving a power triac in a DIP-8 package. It provides a 5300 V of input to output isolation.

ORDERING INFORMATION

V	O	2	2	2	3	A	-	X	0	0	#
PART NUMBER							PACKAGE OPTION				



AGENCY CERTIFIED/PACKAGE	TRIGGER, CURRENT I_{FT} (mA)
UL, cUL	10
DIP-8	VO2223A
VDE, UL, cUL	10
DIP-8	VO2223A-X001

ABSOLUTE MAXIMUM RATINGS ($T_{amb} = 25\text{ }^{\circ}\text{C}$, unless otherwise specified)

PARAMETER	TEST CONDITION	SYMBOL	VALUE	UNIT
INPUT				
LED continuous forward current		I_F	50	mA
LED reverse voltage		V_R	5	V
OUTPUT				
Repetitive peak off-state voltage	Sine wave, 50 Hz to 60 Hz, gate open	V_{DRM}	600	V
On-state RMS current		$I_{T(RMS)}$	1	A
Peak non-repetitive surge current (50 Hz, peak)		I_{TSM}	10	A
COUPLER				
Total power dissipation ⁽²⁾		P_{diss}	1.2	W
Ambient temperature range		T_{amb}	- 40 to + 85	$^{\circ}\text{C}$
Storage temperature range		T_{stg}	- 40 to + 125	$^{\circ}\text{C}$
Soldering temperature ⁽¹⁾	$t \leq 10$ s max.	T_{sld}	260	$^{\circ}\text{C}$
Isolation test voltage	for 1 s	V_{ISO}	5300	V_{RMS}

Notes

- Stresses in excess of the absolute maximum ratings can cause permanent damage to the device. Functional operation of the device is not implied at these or any other conditions in excess of those given in the operational sections of this document. Exposure to absolute maximum ratings for extended periods of the time can adversely affect reliability.

⁽¹⁾ Refer to wave profile for soldering conditions for through hole devices.

⁽²⁾ Total power dissipation value is based on 2S2P PCB.

ABSOLUTE MAXIMUM RATING CURVES

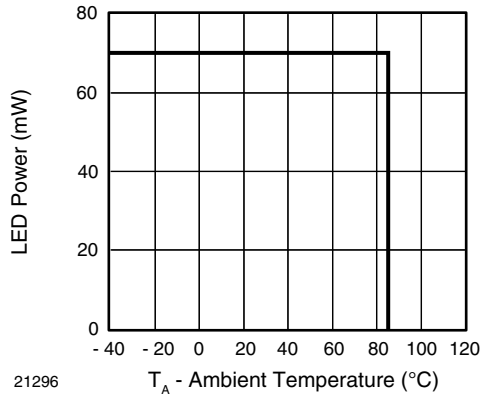


Fig. 1 - Power Dissipation vs. Temperature

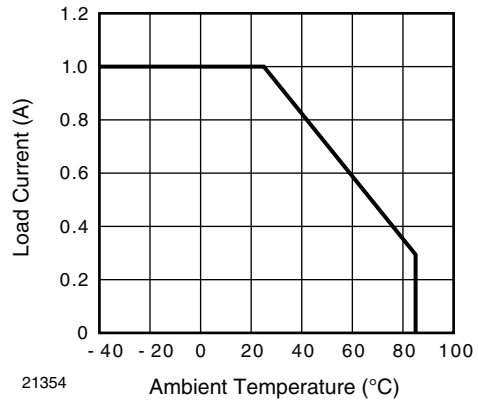


Fig. 2 - Allowable Load Current vs. Ambient Temperature

Note

- The allowable load current was calculated out under a given operating conditions and only for reference:
LED power: $Q_E = 0.015 \text{ W}$, $\theta_{BA} \text{ (4-layer)} = 30 \text{ }^\circ\text{C/W}$

ELECTRICAL CHARACTERISTICS ($T_{amb} = 25 \text{ }^\circ\text{C}$, unless otherwise specified)						
PARAMETER	TEST CONDITION	SYMBOL	MIN.	TYP.	MAX.	UNIT
INPUT						
LED trigger current	$V_T = 6 \text{ V}$	I_{FT}			10	mA
Input reverse current	$V_R = 5 \text{ V}$	I_R			10	μA
LED forward voltage	$I_F = 10 \text{ mA}$	V_F	0.9		1.4	V
OUTPUT						
Peak on-state voltage	$I_{TM} = 1 \text{ A}$	V_{TM}			1.7	V
Peak off-state current	$V_{DRM} = 600 \text{ V}$, $T_A = 110 \text{ }^\circ\text{C}$	I_{DRM}			100	μA
Holding current	$R_L = 100 \text{ } \Omega$	I_H			25	mA
Critical rate of rise of off-state voltage	$V_{IN} = 400 \text{ V}_{RMS}$ (fig. 3)	dV/dt_{cr}		210		V/ μs
Critical rate of rise of commutating voltage	$V_{IN} = 240 \text{ V}_{RMS}$, $I_T = 1 \text{ A}_{RMS}$ (fig. 3)	dV/dt_{crq}		0.7		V/ μs

Note

- Minimum and maximum values are testing requirements. Typical values are characteristics of the device and are the result of engineering evaluations. Typical values are for information only and are not part of the testing requirements.

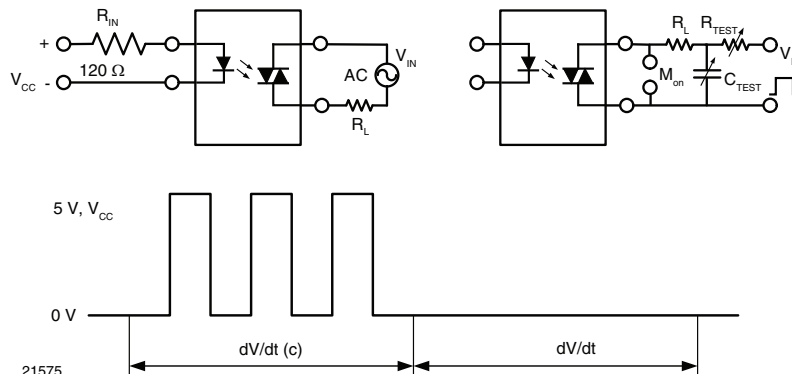


Fig. 3 - dV/dt Test Circuit

SAFETY AND INSULATION RATINGS						
PARAMETER	TEST CONDITION	SYMBOL	MIN.	TYP.	MAX.	UNIT
Climatic classification	IEC 68 part 1			40/85/21		
Pollution degree	DIN VDE 0109			2		
Tracking resistance (comparative tracking index)	Insulation group IIIa	CTI	175			
Highest allowable overvoltage	Transient overvoltage	V_{IOTM}	8000			V_{peak}
Maximum working insulation voltage	Recurring peak voltage	V_{IORM}	890			V_{peak}
Insulation resistance at 25 °C	$V_{IO} = 500\text{ V}$	R_{IS}			$\geq 10^{12}$	Ω
Insulation resistance at T_S	$V_{IO} = 500\text{ V}$	R_{IS}			$\geq 10^9$	Ω
Insulation resistance at 100 °C	$V_{IO} = 500\text{ V}$	R_{IS}			$\geq 10^{11}$	Ω
Partial discharge test voltage	Method b, $V_{pd} = V_{IORM} \times 1.6$	V_{pd}			1424	V_{peak}
Safety limiting values - maximum values allowed in the event of a failure	Case temperature	T_{SI}			165	°C
	Input current	I_{SI}			150	mA
	Output power	P_{SO}			2000	mW
Minimum external air gap (clearance distance)	Measured from input terminals to output terminals, shortest distance through air		≥ 7			mm
Minimum external tracking (creepage distance)	Measured from input terminals to output terminals, shortest distance path along body		≥ 7			mm

Note

- This phototriac coupler is suitable for “safe electrical insulation” only within the safety ratings. Compliance with safety ratings shall be ensured by means of protective circuits.

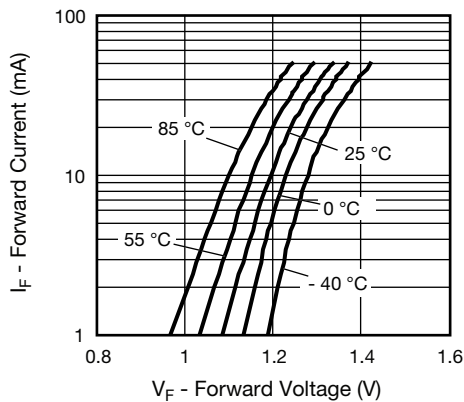
TYPICAL CHARACTERISTICS ($T_{amb} = 25\text{ °C}$, unless otherwise specified)


Fig. 4 - Forward Current vs. Forward Voltage

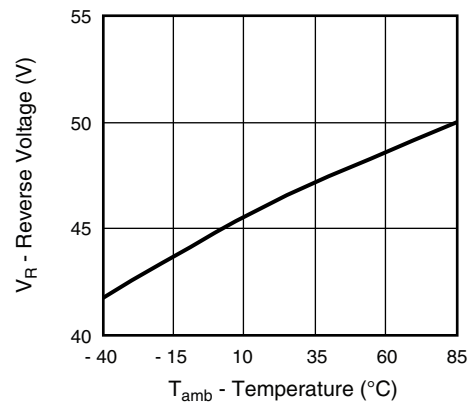


Fig. 5 - Reverse Voltage vs. Temperature

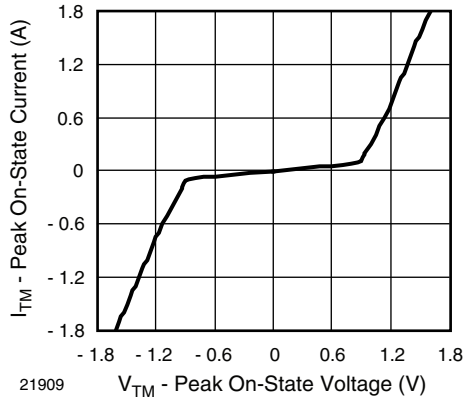


Fig. 6 - On-State Current vs. On-State Voltage

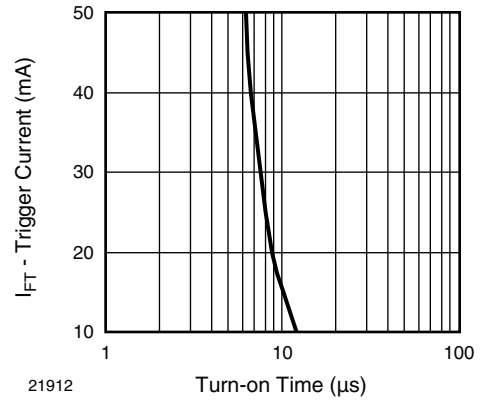


Fig. 9 - Trigger Input Current vs. Turn-on Time

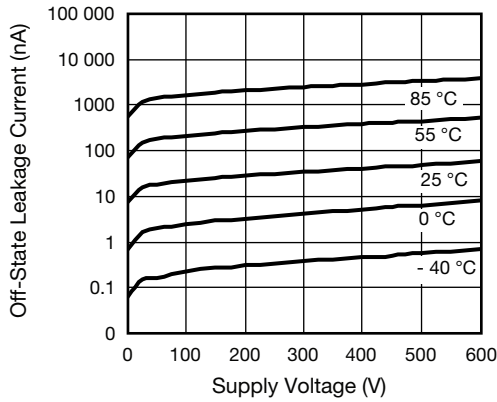


Fig. 7 - Off-State Leakage Current vs. Voltage

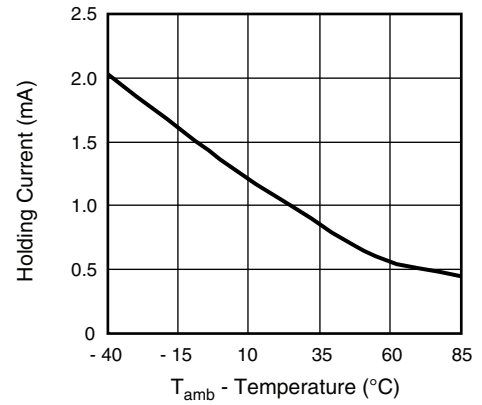


Fig. 10 - Normalized Holding Current vs. Temperature

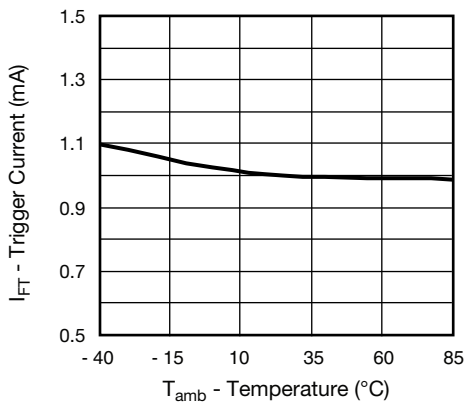


Fig. 8 - Normalized Trigger Input Current vs. Temperature

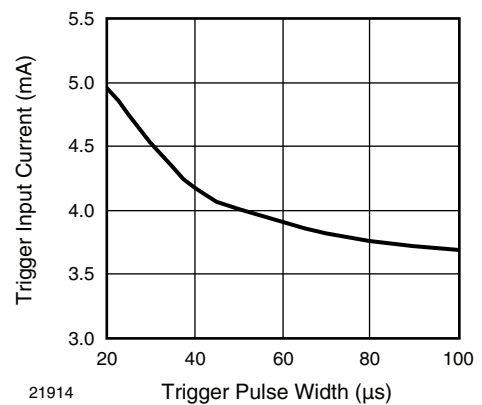


Fig. 11 - Trigger Current vs. Trigger Pulse Width

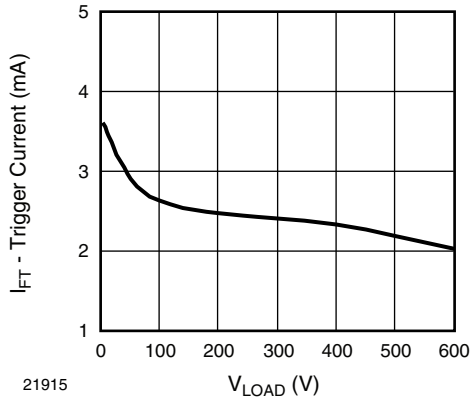
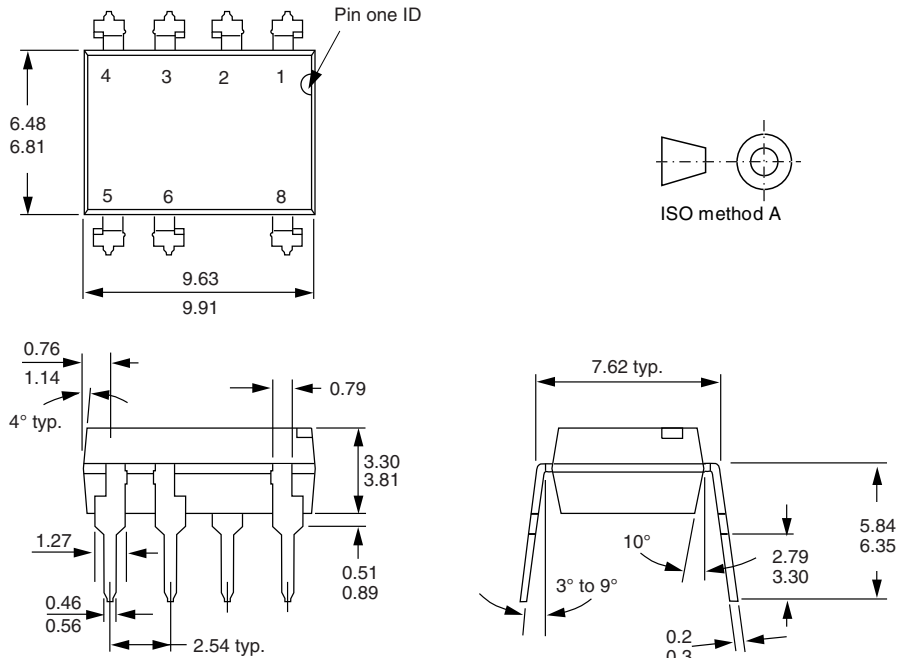


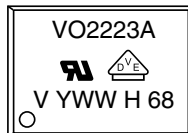
Fig. 12 - Trigger Current vs. V_{LOAD}

PACKAGE DIMENSIONS in millimeters



i178006-1

PACKAGE MARKING (example of VO2223A-X001)





Disclaimer

ALL PRODUCT, PRODUCT SPECIFICATIONS AND DATA ARE SUBJECT TO CHANGE WITHOUT NOTICE TO IMPROVE RELIABILITY, FUNCTION OR DESIGN OR OTHERWISE.

Vishay Intertechnology, Inc., its affiliates, agents, and employees, and all persons acting on its or their behalf (collectively, "Vishay"), disclaim any and all liability for any errors, inaccuracies or incompleteness contained in any datasheet or in any other disclosure relating to any product.

Vishay makes no warranty, representation or guarantee regarding the suitability of the products for any particular purpose or the continuing production of any product. To the maximum extent permitted by applicable law, Vishay disclaims (i) any and all liability arising out of the application or use of any product, (ii) any and all liability, including without limitation special, consequential or incidental damages, and (iii) any and all implied warranties, including warranties of fitness for particular purpose, non-infringement and merchantability.

Statements regarding the suitability of products for certain types of applications are based on Vishay's knowledge of typical requirements that are often placed on Vishay products in generic applications. Such statements are not binding statements about the suitability of products for a particular application. It is the customer's responsibility to validate that a particular product with the properties described in the product specification is suitable for use in a particular application. Parameters provided in datasheets and/or specifications may vary in different applications and performance may vary over time. All operating parameters, including typical parameters, must be validated for each customer application by the customer's technical experts. Product specifications do not expand or otherwise modify Vishay's terms and conditions of purchase, including but not limited to the warranty expressed therein.

Except as expressly indicated in writing, Vishay products are not designed for use in medical, life-saving, or life-sustaining applications or for any other application in which the failure of the Vishay product could result in personal injury or death. Customers using or selling Vishay products not expressly indicated for use in such applications do so at their own risk. Please contact authorized Vishay personnel to obtain written terms and conditions regarding products designed for such applications.

No license, express or implied, by estoppel or otherwise, to any intellectual property rights is granted by this document or by any conduct of Vishay. Product names and markings noted herein may be trademarks of their respective owners.

Material Category Policy

Vishay Intertechnology, Inc. hereby certifies that all its products that are identified as RoHS-Compliant fulfill the definitions and restrictions defined under Directive 2011/65/EU of The European Parliament and of the Council of June 8, 2011 on the restriction of the use of certain hazardous substances in electrical and electronic equipment (EEE) - recast, unless otherwise specified as non-compliant.

Please note that some Vishay documentation may still make reference to RoHS Directive 2002/95/EC. We confirm that all the products identified as being compliant to Directive 2002/95/EC conform to Directive 2011/65/EU.

Vishay Intertechnology, Inc. hereby certifies that all its products that are identified as Halogen-Free follow Halogen-Free requirements as per JEDEC JS709A standards. Please note that some Vishay documentation may still make reference to the IEC 61249-2-21 definition. We confirm that all the products identified as being compliant to IEC 61249-2-21 conform to JEDEC JS709A standards.

Компания «Океан Электроники» предлагает заключение долгосрочных отношений при поставках импортных электронных компонентов на взаимовыгодных условиях!

Наши преимущества:

- Поставка оригинальных импортных электронных компонентов напрямую с производств Америки, Европы и Азии, а так же с крупнейших складов мира;
- Широкая линейка поставок активных и пассивных импортных электронных компонентов (более 30 млн. наименований);
- Поставка сложных, дефицитных, либо снятых с производства позиций;
- Оперативные сроки поставки под заказ (от 5 рабочих дней);
- Экспресс доставка в любую точку России;
- Помощь Конструкторского Отдела и консультации квалифицированных инженеров;
- Техническая поддержка проекта, помощь в подборе аналогов, поставка прототипов;
- Поставка электронных компонентов под контролем ВП;
- Система менеджмента качества сертифицирована по Международному стандарту ISO 9001;
- При необходимости вся продукция военного и аэрокосмического назначения проходит испытания и сертификацию в лаборатории (по согласованию с заказчиком);
- Поставка специализированных компонентов военного и аэрокосмического уровня качества (Xilinx, Altera, Analog Devices, Intersil, Interpoint, Microsemi, Actel, Aeroflex, Peregrine, VPT, Syfer, Eurofarad, Texas Instruments, MS Kennedy, Miteq, Cobham, E2V, MA-COM, Hittite, Mini-Circuits, General Dynamics и др.);

Компания «Океан Электроники» является официальным дистрибьютором и эксклюзивным представителем в России одного из крупнейших производителей разъемов военного и аэрокосмического назначения «JONHON», а так же официальным дистрибьютором и эксклюзивным представителем в России производителя высокотехнологичных и надежных решений для передачи СВЧ сигналов «FORSTAR».



JONHON

«JONHON» (основан в 1970 г.)

Разъемы специального, военного и аэрокосмического назначения:

(Применяются в военной, авиационной, аэрокосмической, морской, железнодорожной, горно- и нефтедобывающей отраслях промышленности)

«FORSTAR» (основан в 1998 г.)

ВЧ соединители, коаксиальные кабели, кабельные сборки и микроволновые компоненты:

(Применяются в телекоммуникациях гражданского и специального назначения, в средствах связи, РЛС, а так же военной, авиационной и аэрокосмической отраслях промышленности).



Телефон: 8 (812) 309-75-97 (многоканальный)

Факс: 8 (812) 320-03-32

Электронная почта: ocean@oceanchips.ru

Web: <http://oceanchips.ru/>

Адрес: 198099, г. Санкт-Петербург, ул. Калинина, д. 2, корп. 4, лит. А