

ISOLATED DC/DC CONVERTERS

48 Vdc Input 1.2-2.5 Vdc/80 A, 3.3 Vdc/70 A, 5 Vdc/48 A, 12 Vdc/20 A Output

bel
POWER PRODUCTS

0RHB-D0T Series

RoHS Compliant

Rev.A

- Isolated
- High Efficiency
- High Power Density
- Low Cost
- Input Under Voltage Lockout
- Fixed frequency (330 kHz)
- Basic Isolation
- Input Over Voltage Lockout
- Output Over Voltage Shutdown
- OCP/SCP
- Over Temperature Protection
- Remote On/Off
- Output Voltage Trim
- Positive/Negative Remote Sense
- Remote On/Off Logic (option)
- UL60950-1 Recognized (UL/cUL)



Description

The 0RHB-D0T Series are isolated dc/dc converters that operate from a nominal 48 Vdc source. These units provide up to 200 W of output power from a nominal 48 Vdc input. These units are designed to be highly efficient and low cost. Features include remote on/off, over current protection and under voltage lockout. These converters are provided in an industry standard half-brick package.

Part Selection

Output Voltage	Input Voltage	Max. Output Current	Max. Output Power	Typical Efficiency	Model Number Active High	Model Number Active Low
12.0 V	36 V - 75 V	20 A	240 W	94%	0RHB-D0T120	0RHB-D0T12L
5.0 V	36 V - 75 V	48 A	240 W	92.5%	0RHB-D0T050	0RHB-D0T05L
3.3 V	36 V - 75 V	70 A	231 W	92%	0RHB-D0T033	0RHB-D0T03L
2.5 V	36 V - 75 V	80 A	200 W	91%	0RHB-D0T025	0RHB-D0T02L
1.8 V	36 V - 75 V	80 A	144 W	89%	0RHB-D0TV80	0RHB-D0TV8L
1.5 V	36 V - 75 V	80 A	120 W	87%	0RHB-D0TV50	0RHB-D0TV5L
1.2 V	36 V - 75 V	80 A	96 W	85%	0RHB-D0TV20	0RHB-D0TV2L

- Notes:** 1. Add "G" suffix at the end of the model number to indicate Tray Packaging.
2. All part numbers above indicate RoHS 6. Change the second letter "R" to "7" for RoHS 5 part numbers.

Absolute Maximum Ratings

Parameter	Min	Typ	Max	Notes
Input Voltage (continuous)	-0.3 V	-	80 V	
Remote On/Off	-0.3 V	-	18 V	
I/O Isolation Voltage	-	-	2000 V	
Ambient Temperature	-40 °C	-	85 °C	
Storage Temperature	-55 °C	-	125 °C	

ISOLATED DC/DC CONVERTERS

48 Vdc Input 1.2-2.5 Vdc/80 A, 3.3 Vdc/70 A, 5 Vdc/48 A, 12 Vdc/20 A Output



Input Specifications

Parameter	Min	Typ	Max	Notes
Input Voltage	36 V	48 V	75 V	
Input Current (full load)				
Vo=12.0 V	-	-	7.5 A	
Vo=5.0 V	-	-	7.5 A	
Vo=3.3 V	-	-	7.3 A	
Vo=2.5 V	-	-	6.4 A	
Vo=1.8 V	-	-	4.7 A	
Vo=1.5 V	-	-	4.0 A	
Vo=1.2 V	-	-	3.3 A	
Input Current (no load)	-	120 mA	180 mA	
Remote Off Input Current		5 mA	10 mA	
Input Reflected Ripple Current (pk-pk)	-	20 mA	40 mA	Tested with simulated source impedance of 10 uH, 5 Hz to 20 MHz; use a 100 uF/100 V electrolytic capacitor with ESR = 1 ohm max. at 200 kHz at 25 °C.
Input Reflected Ripple Current (rms)	-	5 mA	10 mA	
I ² t Inrush Current Transient	-	0.05 A ² s	0.1 A ² s	
Turn-on Voltage Threshold	32 V	34 V	35 V	
Turn-off Voltage Threshold	30 V	32 V	34 V	
Input Over Voltage Lockout	76 V	78 V	80 V	

Output Specifications

Parameter	Min	Typ	Max	Notes
Output Voltage Set Point				
Vo=12.0 V	11.760 V	12.000 V	12.240 V	Vin=48 V, Io=50% full load, Ta=25 °C.
Vo=5.0 V	4.925 V	5.000 V	5.075 V	
Vo=3.3 V	3.250 V	3.300 V	3.350 V	
Vo=2.5 V	2.462 V	2.500 V	2.538 V	
Vo=1.8 V	1.773 V	1.800 V	1.827 V	
Vo=1.5 V	1.477 V	1.500 V	1.523 V	
Vo=1.2 V	1.176 V	1.200 V	1.224 V	
Line Regulation				
Vo=12.0 V	-	±12 mV	±24 mV	
Vo=5.0 V	-	±5 mV	±10 mV	
Vo=3.3 V	-	±3 mV	±7 mV	
Vo=1.2 V - 2.5 V	-	±3 mV	±6 mV	
Load Regulation				
Vo=12.0 V	-	±30 mV	±60 mV	
Vo=5.0 V	-	±10 mV	±20 mV	
Vo=3.3 V	-	±7 mV	±15 mV	
Vo=2.5 V	-	±6 mV	±13 mV	
Vo=1.8 V	-	±5 mV	±9 mV	
Vo=1.5 V	-	±4 mV	±8 mV	
Vo=1.2 V	-	±3 mV	±6 mV	
Regulation Over Temperature (-40 °C to +85 °C)				
Vo=12.0 V	-	±60 mV	±100 mV	
Vo=5.0 V	-	±45 mV	±75 mV	
Vo=3.3 V	-	±30 mV	±50 mV	
Vo=2.5 V	-	±25 mV	±45 mV	
Vo=1.8 V	-	±20 mV	±40 mV	
Vo=1.5 V	-	±20 mV	±35 mV	
Vo=1.2 V	-	±15 mV	±30 mV	

ISOLATED DC/DC CONVERTERS

48 Vdc Input 1.2-2.5 Vdc/80 A, 3.3 Vdc/70 A, 5 Vdc/48 A, 12 Vdc/20 A Output



Output Specifications (continued)

Parameter		Min	Typ	Max	Notes	
Output Current	Vo=12.0 V	0 A	-	20 A		
	Vo=5.0 V	0 A	-	48 A		
	Vo=3.3 V	0 A	-	70 A		
	Vo=1.2 V - 2.5 V	0 A	-	80 A		
Current Limit Threshold	Vo=12.0 V	21 A	25 A	30 A	Hiccup Mode	
	Vo=5.0 V	50 A	58 A	66 A		
	Vo=3.3 V	74 A	84 A	94 A		
	Vo=1.2 V - 2.5 V	86 A	96 A	106 A		
Short Circuit Surge Transient		-	3 A ² s	5 A ² s		
Ripple and Noise (rms)	Vo=12.0 V	-	30 mV	50 mV	Test conditions: 0-20 MHz BW, with a 1 uF ceramic capacitor and a 10 uF Tantalum capacitor at the output.	
	Vo=5.0 V	-	25 mV	50 mV		
	Vo=3.3 V	-	20 mV	40 mV		
	Vo=1.2 V - 2.5 V	-	15 mV	30 mV		
Ripple and Noise (pk-pk)	Vo=12.0 V	-	100 mV	150 mV		
	Vo=5.0 V	-	80 mV	150 mV		
	Vo=3.3 V	-	55 mV	100 mV		
	Vo=1.2 V - 2.5 V	-	40 mV	80 mV		
Turn on Time	Vo=5.0 V - 12.0 V	10 mS	-	30 mS		
	Vo=3.3 V	8 mS	-	20 mS		
	Vo=1.2 V - 2.5 V	5 mS	-	15 mS		
Overshoot at Turn on		-	0%	5%		
Output Capacitance	Vo=12.0 V	0 uF	-	2200 uF		
	Vo=5.0 V	0 uF	-	10000 uF		
	Vo=1.2 V - 3.3 V	0 uF	-	20000 uF		
Transient Response						
50% ~ 75% Max Load	Overshoot	Vo=12.0 V	-	600 mV	800 mV	Test conditions: di/dt = 0.1 A/uS, Vin=48 V, Ta=25 °C with a 1 uF ceramic capacitor and a 10 uF Tantalum capacitor at the output.
	Settling Time		-	300 uS	500 uS	
75% ~ 50% Max Load	Overshoot	Vo=12.0 V	-	600 mV	800 mV	
	Settling Time		-	300 uS	500 uS	
50% ~ 75% Max Load	Overshoot	Vo=5.0 V	-	250 mV	400 mV	
	Settling Time		-	250 uS	400 uS	
75% ~ 50% Max Load	Overshoot	Vo=5.0 V	-	250 mV	400 mV	
	Settling Time		-	250 uS	400 uS	
50% ~ 75% Max Load	Overshoot	Vo=3.3 V	-	150 mV	200 mV	
	Settling Time		-	200 uS	300 uS	
75% ~ 50% Max Load	Overshoot	Vo=3.3 V	-	150 mV	200 mV	
	Settling Time		-	200 uS	300 uS	
50% ~ 75% Max Load	Overshoot	Vo=1.2 V - 2.5 V	-	100 mV	200 mV	
	Settling Time		-	200 uS	300 uS	
75% ~ 50% Max Load	Overshoot	Vo=1.2 V - 2.5 V	-	100 mV	200 mV	
	Settling Time		-	200 uS	300 uS	

Note: All specifications are typical at nominal input, full load at 25 °C unless noted.

ISOLATED DC/DC CONVERTERS

48 Vdc Input 1.2-2.5 Vdc/80 A, 3.3 Vdc/70 A, 5 Vdc/48 A, 12 Vdc/20 A Output



General Specifications

Parameter	Min	Typ	Max	Notes
Efficiency				Vin=48 V, full load, Ta=25 °C
Vo=12.0 V	91%	94%	-	
Vo=5.0 V	89%	92.5%	-	
Vo=3.3 V	89%	92%	-	
Vo=2.5 V	88%	91%	-	
Vo=1.8 V	86%	89%	-	
Vo=1.5 V	84%	87%	-	
Vo=1.2 V	82%	85%	-	
Switching Frequency	280 kHz	330 kHz	380 kHz	
Isolation capacitance	-	1500 pF	-	
Remote Sense Compensation	-	-	10% Vo	The total voltage increased by trim and remote sense should not exceed 10%Vo.
Output Voltage Trim Range	80% Vo	-	110% Vo	
Over Temperature Protection	-	125 °C	-	
Over Voltage Protection	-	130% Vo	-	Vin=48V, full load, Hiccup mode
MTBF	1,113,071 hours			Calculated Per Bell Core SR-332 (Vin=48 V; Vo=2.5 V, Io = 80%Iomax; Ta = 25 °C)
Dimensions	Inches millimeters			
	2.28 x 2.4 x 0.42 57.51 x 60.98 x 10.67			
Weight	-	76 g	-	

Note: All specifications are typical at nominal input, full load at 25 °C unless noted.

Control Specifications

Parameter	Min	Typ	Max	Notes	
Remote On/Off					
Signal Low (Unit On)	Active Low	-0.3 V	-	0.8 V	0RHB-D0TxxL. The remote on/off pin open, Unit off.
Signal High (Unit Off)		2.4 V	-		
Signal Low (Unit Off)	Active High	-0.3 V	-	0.8 V	0RHB-D0Txx0. The remote on/off pin open, Unit on.
Signal High (Unit On)		2.4 V	-		
Current Sink	0 mA	-	0.75 mA		

ISOLATED DC/DC CONVERTERS

48 Vdc Input 1.2-2.5 Vdc/80 A, 3.3 Vdc/70 A, 5 Vdc/48 A, 12 Vdc/20 A Output



Output Trim Equations

Equations for calculating the trim resistor (in kΩ) are shown below. The Trim Down resistor should be connected between the Trim pin and Ground pin. The Trim Up resistor should be connected between the Trim pin and the Vout. Only one of the resistors should be used for any given application.

$$R_{trimdown} = \frac{100}{|\delta|} - 2$$

1.5 V-12 V:

$$R_{trimup} = \frac{(100 + \delta) \cdot V_o - 122.5}{1.225 \cdot \delta} - 2$$

1.2 V:

$$R_{trimup} = \frac{(100 + \delta) \cdot V_o - 61.25}{0.6125 \cdot \delta} - 2$$

Notes:

$$\delta = \frac{(V_o_{req} - V_o)}{V_o} \times 100[\%]$$

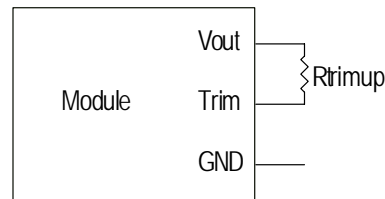
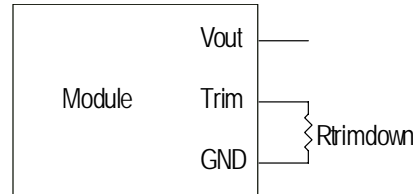

V_o_{req} = Desired (trimmed) output voltage [V]

Output voltage V_o = 3.308 V for 3.3 V output; V_o = 5.000 V for 5.0 V; V_o = 12.000 V for 12 V output

Efficiency Data

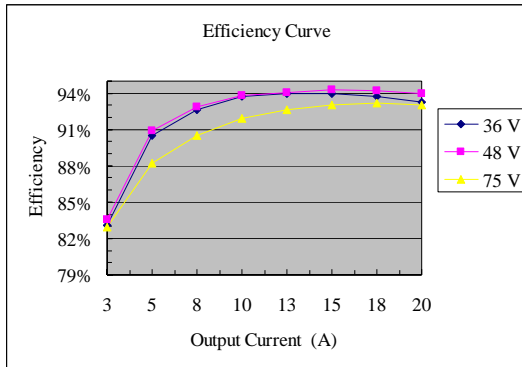

ORHB-D0T12x

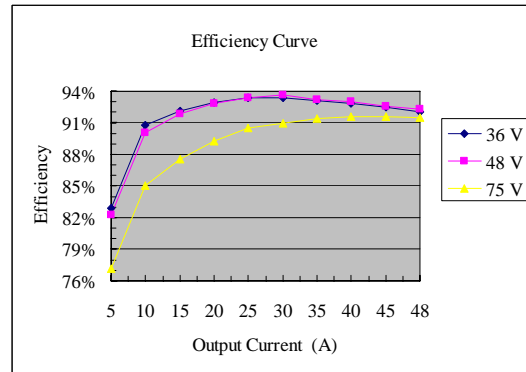

ORHB-D0T05x

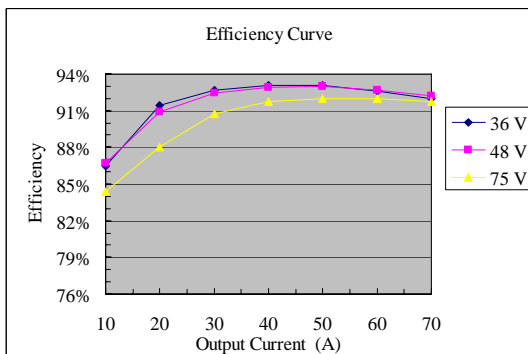

ORHB-D0T03x

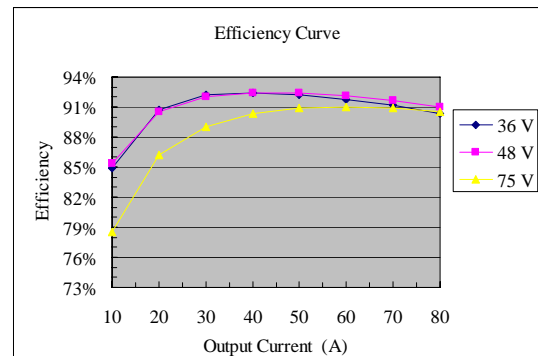

ORHB-D0T02x

ISOLATED DC/DC CONVERTERS

48 Vdc Input 1.2-2.5 Vdc/80 A, 3.3 Vdc/70 A, 5 Vdc/48 A, 12 Vdc/20 A Output



Efficiency Data (continued)

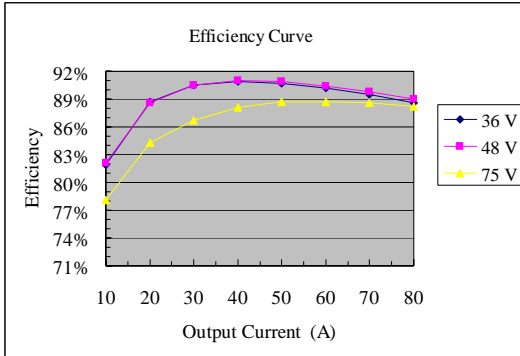

ORHB-D0TV8x

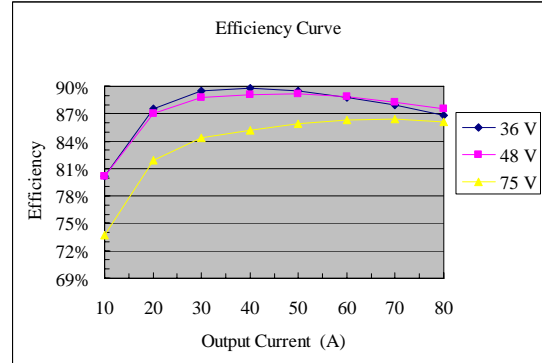

ORHB-D0TV5x

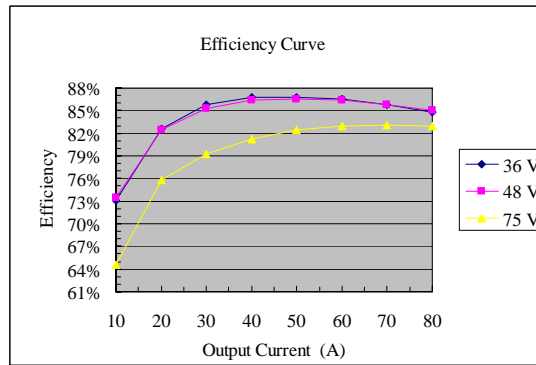

ORHB-D0TV2x

Thermal Derating Curves

FORCED AIRFLOW DIRECTION

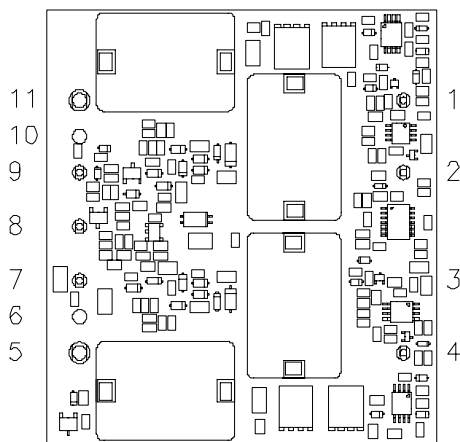

BOTTOM VIEW

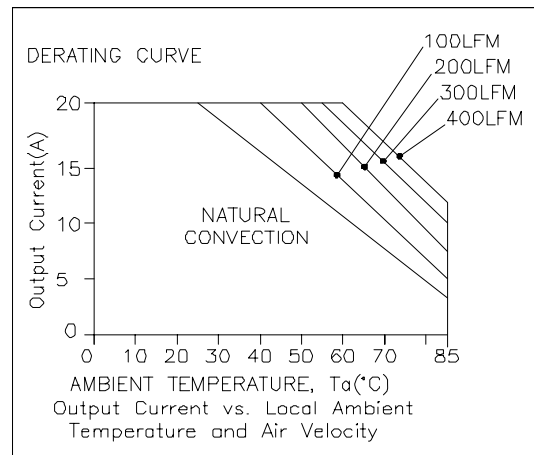

ORHB-D0T12x

ISOLATED DC/DC CONVERTERS

48 Vdc Input 1.2-2.5 Vdc/80 A, 3.3 Vdc/70 A, 5 Vdc/48 A, 12 Vdc/20 A Output



Thermal Derating Curves (continued)

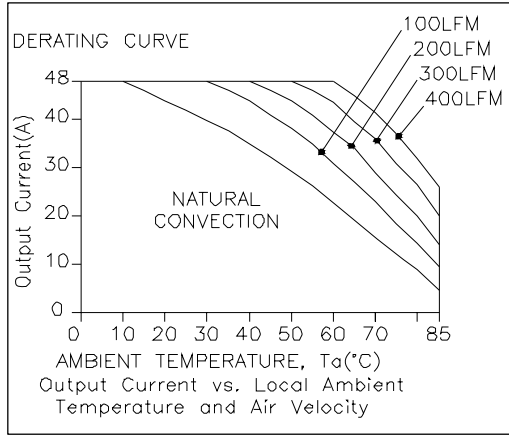

0RHB-D0T05x

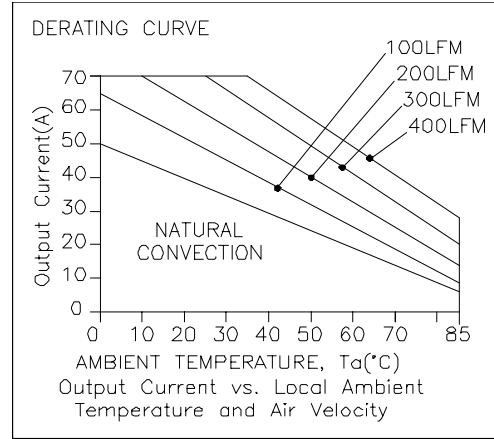

0RHB-D0T03x

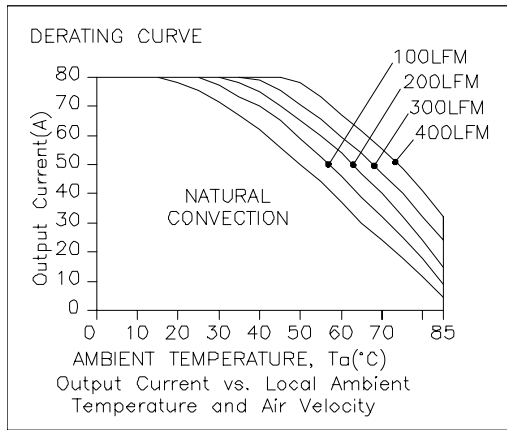

0RHB-D0T02x

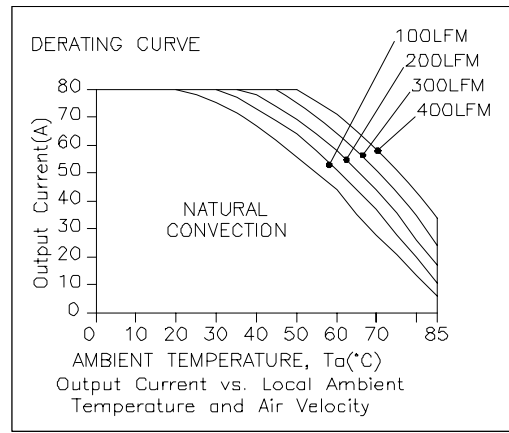

0RHB-D0TV8x

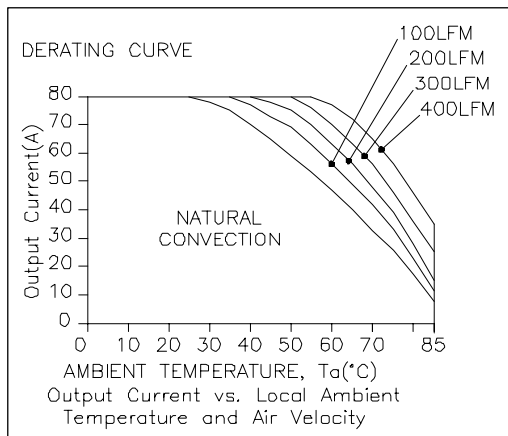

0RHB-D0TV5x

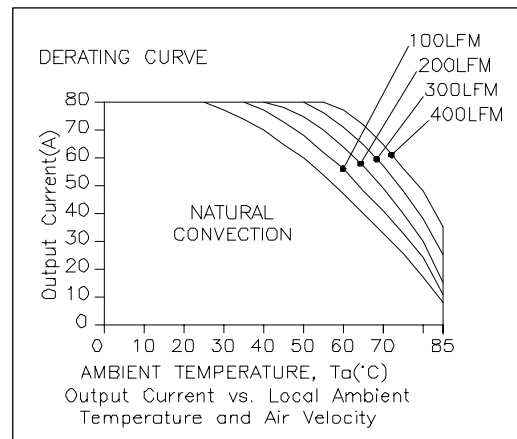

0RHB-D0TV2x

ISOLATED DC/DC CONVERTERS

48 Vdc Input 1.2-2.5 Vdc/80 A, 3.3 Vdc/70 A, 5 Vdc/48 A, 12 Vdc/20 A Output



Ripple and Noise Waveforms

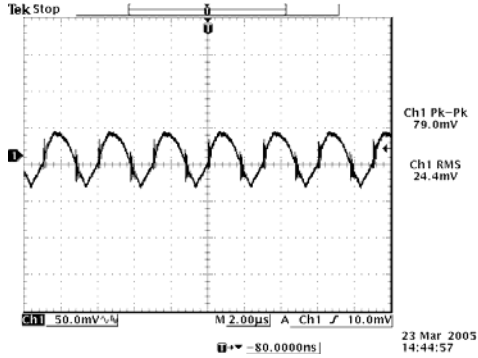

48 Vdc input, 12 Vdc/20 A output

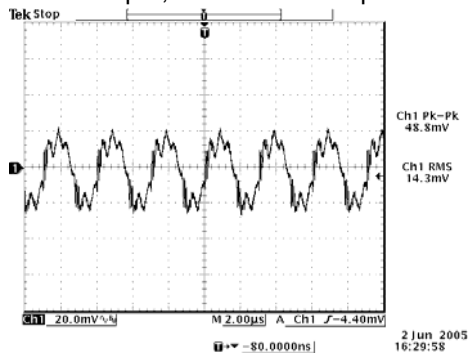

48 Vdc input, 3.3 Vdc/70 A output

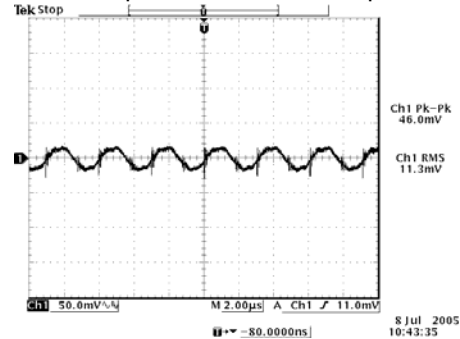

48 Vdc input, 1.8 Vdc/80 A output

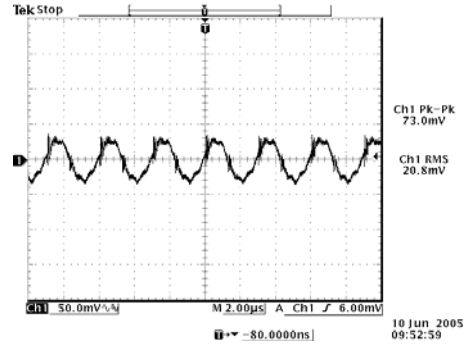

48 Vdc input, 5 Vdc/48 A output

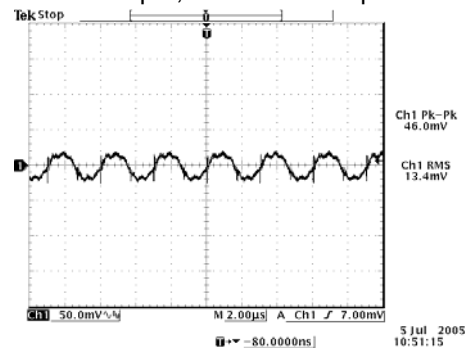

48 Vdc input, 2.5 Vdc/80 A output

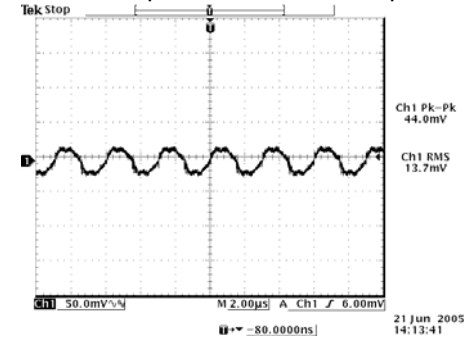

48 Vdc input, 1.5 Vdc/80 A output

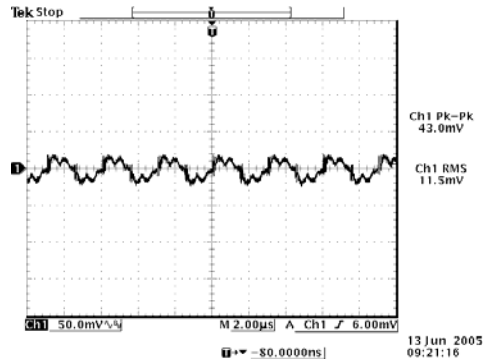

48 Vdc input, 1.2 Vdc/80 A output

Note: Ripple and noise at full load, with a 1uF ceramic cap and a 10 uF Tantalum cap at output, Ta=25 deg C.

ISOLATED DC/DC CONVERTERS

48 Vdc Input 1.2-2.5 Vdc/80 A, 3.3 Vdc/70 A, 5 Vdc/48 A, 12 Vdc/20 A Output



Transient Response Waveforms

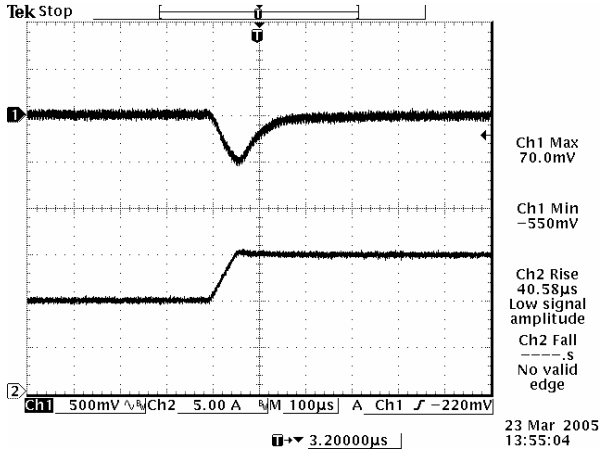

Vout=12 V, 50% to 75% Load Transients

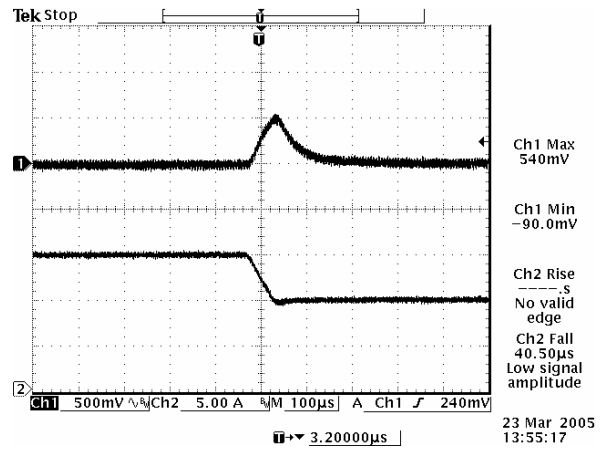

Vout=12 V, 75% to 50% Load Transients

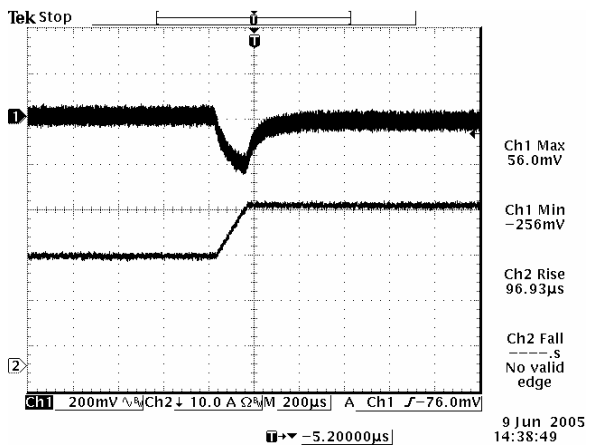

Vout=5 V, 50% to 75% Load Transients

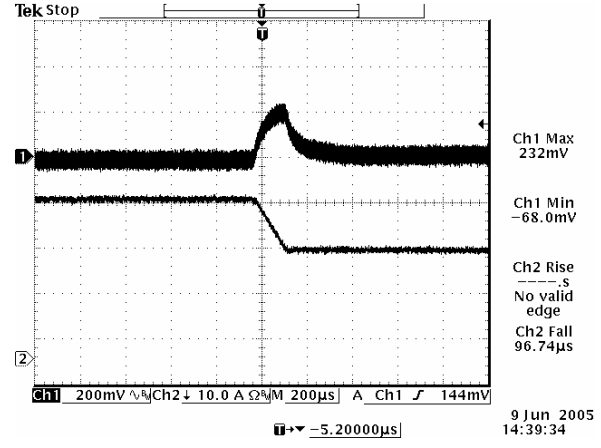

Vout=5 V, 75% to 50% Load Transients

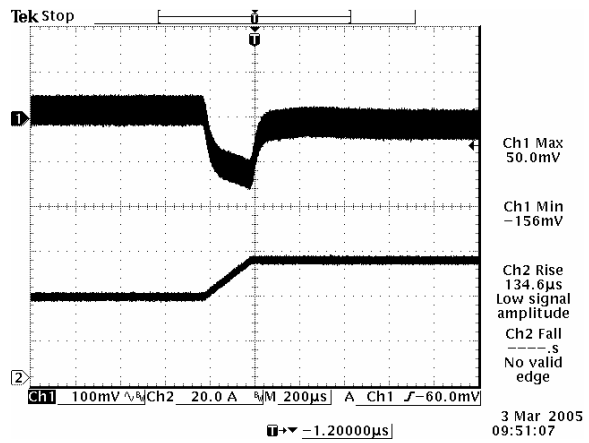

Vout=3.3 V, 50% to 75% Load Transients

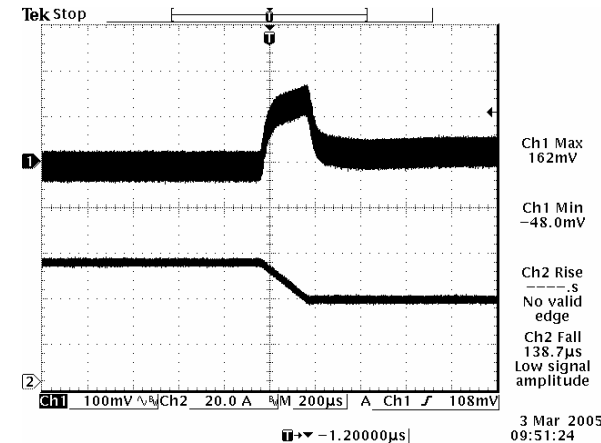

Vout=3.3 V, 75% to 50% Load Transients

ISOLATED DC/DC CONVERTERS

48 Vdc Input 1.2-2.5 Vdc/80 A, 3.3 Vdc/70 A, 5 Vdc/48 A, 12 Vdc/20 A Output



Transient Response Waveforms (continued)

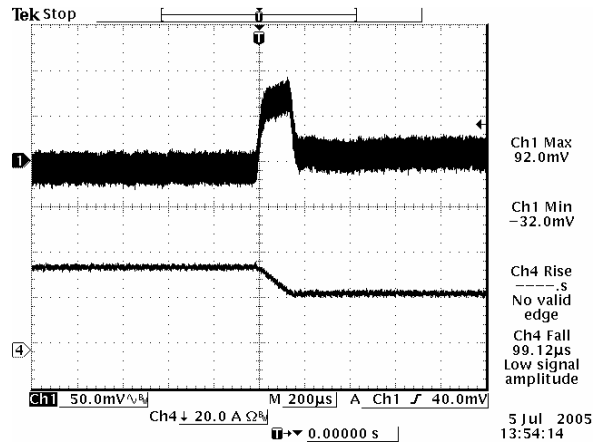
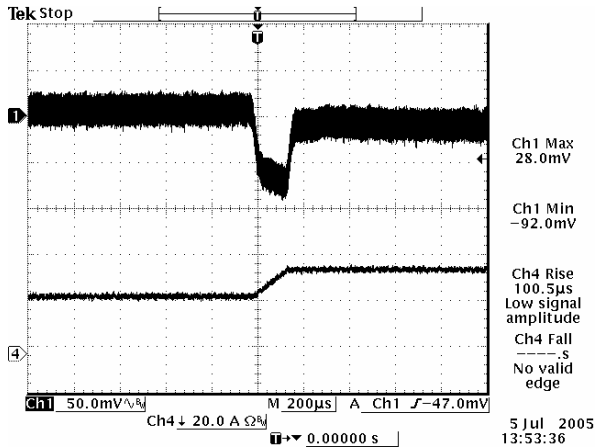

Vout=2.5 V, 50% to 75% Load Transients

Vout=2.5 V, 75% to 50% Load Transients

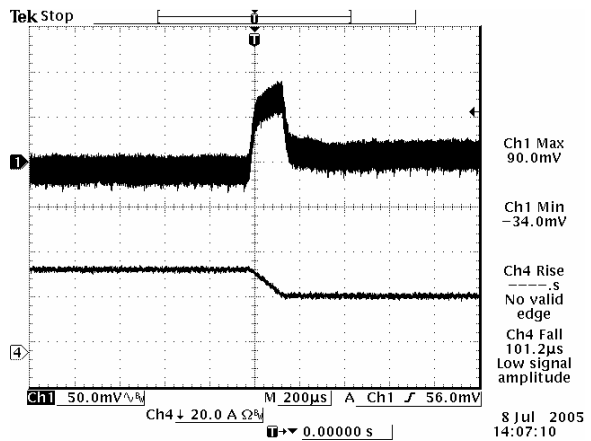
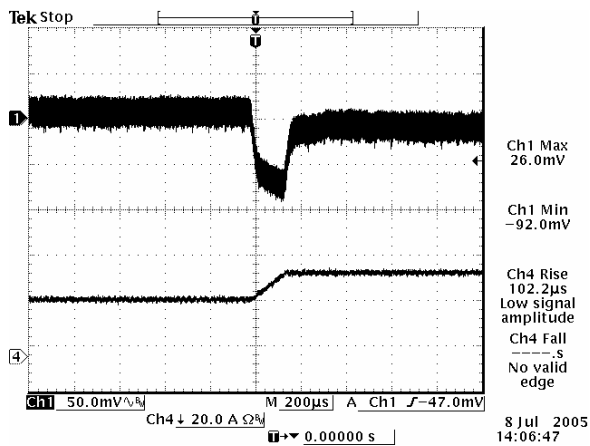

Vout=1.8 V, 50% to 75% Load Transients

Vout=1.8 V, 75% to 50% Load Transients

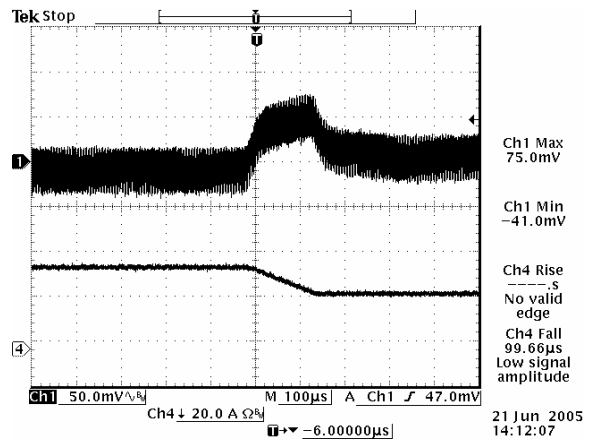
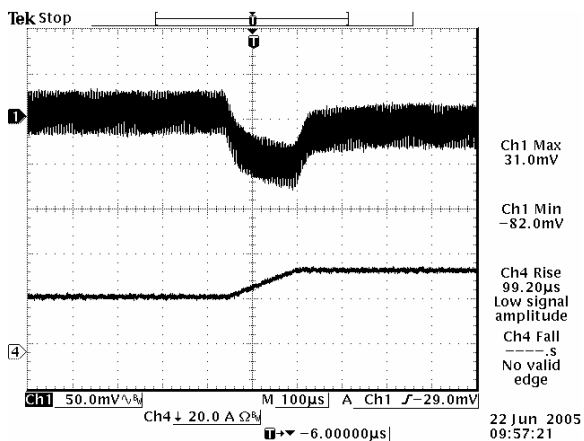

Vout=1.5 V, 50% to 75% Load Transients

Vout=1.5 V, 75% to 50% Load Transients

ISOLATED DC/DC CONVERTERS

48 Vdc Input 1.2-2.5 Vdc/80 A, 3.3 Vdc/70 A, 5 Vdc/48 A, 12 Vdc/20 A Output



Transient Response Waveforms (continued)

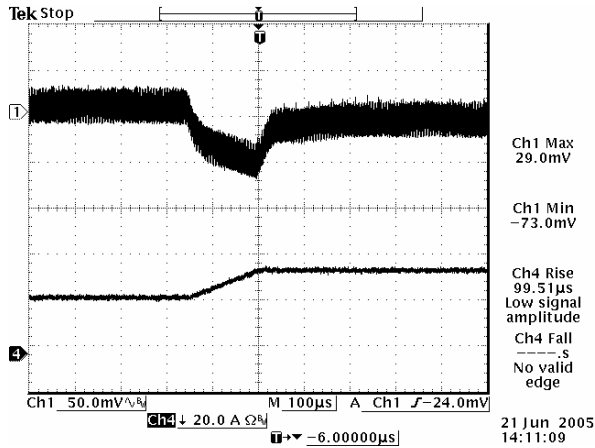

Vout=1.2 V, 50% to 75% Load Transients

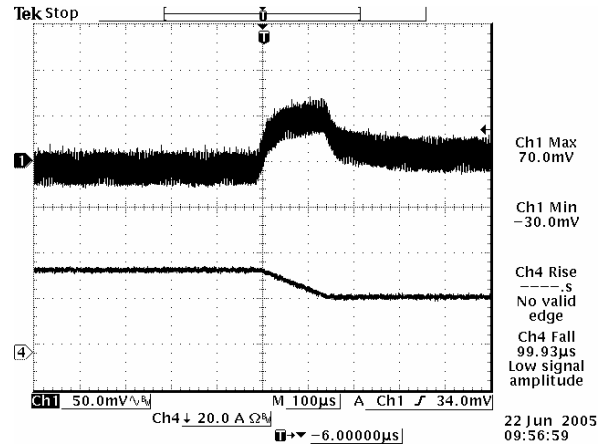

Vout=1.2 V, 75% to 50% Load Transients

Note: Transient Response at di/dt=0.1 A/us, Vin=48 Vdc, Ta=25 °C, with a 1 µF ceramic capacitor and a 10 µF tantalum capacitor at output.

Mechanical Outline

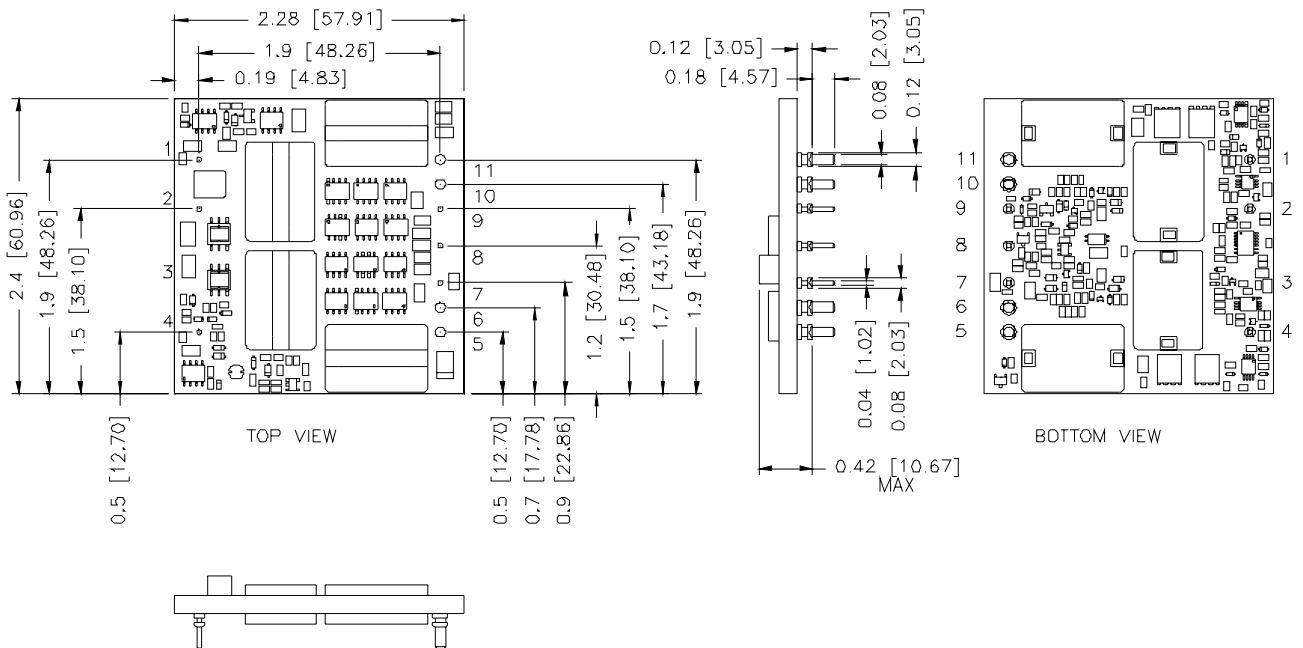

ISOLATED DC/DC CONVERTERS

48 Vdc Input 1.2-2.5 Vdc/80 A, 3.3 Vdc/70 A, 5 Vdc/48 A, 12 Vdc/20 A Output



Mechanical Outline (continued)

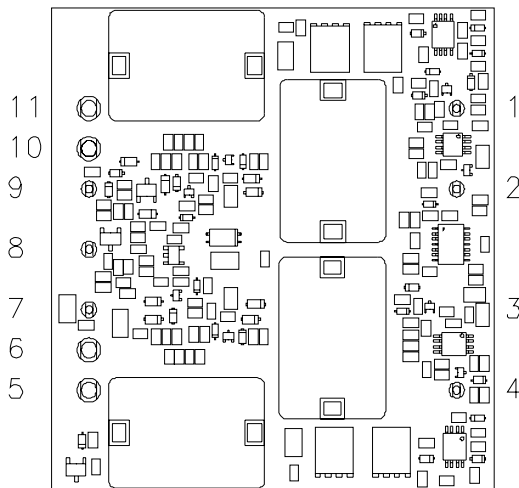

BOTTOM VIEW

Pin Connections

pin#	function	pin size	pin#	function	pin size
1	+Input	0.04"	7	-Sense	0.04"
2	On/Off	0.04"	8	Trim	0.04"
3	N/A		9	+Sense	0.04"
4	-Input	0.04"	10	+Output	0.08"
5	-Output	0.08"	11	+Output	0.08"
6	-Output	0.08"			

- Notes:**
1. Pin 7 must be connected to -Output.
 2. Leave Pin 8 open for nominal voltage.
 3. Pin 9 must be connected to +Output.

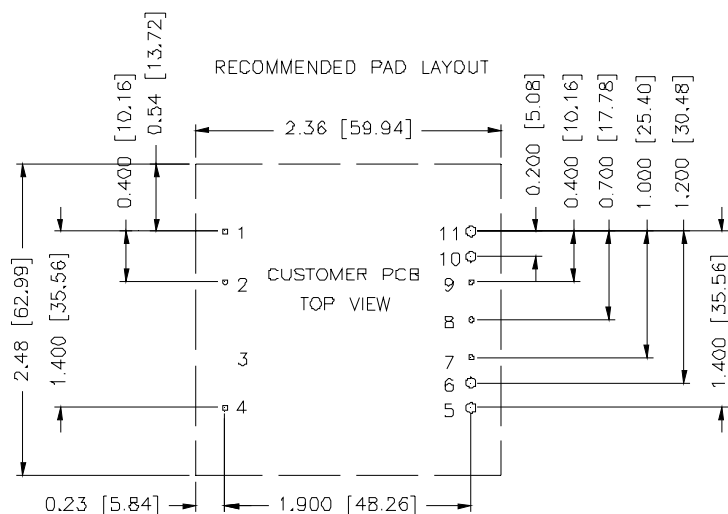

- 1,2,4,7,8,9 ϕ 0.047 PAD HOLE SIZE,
 ϕ 0.08 min PAD SIZE, BOTH SIDE.
 5,6,10,11 ϕ 0.093 HOLE SIZE,
 ϕ 0.12 min PAD SIZE, BOTH SIDE.

RoHS Compliance

Complies with the European Directive 2002/95/EC, calling for the elimination of lead and other hazardous substances from electronic products.



©2007 Bel Fuse Inc. Specifications subject to change without notice. 030307

CORPORATE

Bel Fuse Inc.
 206 Van Vorst Street
 Jersey City, NJ 07302
 Tel 201-432-0463
 Fax 201-432-9542
www.belfuse.com

FAR EAST

Bel Fuse Ltd.
 8F/ 8 Luk Hop Street
 San Po Kong
 Kowloon, Hong Kong
 Tel 852-2328-5515
 Fax 852-2352-3706
www.belfuse.com

EUROPE

Bel Fuse Europe Ltd.
 Preston Technology Management Centre
 Marsh Lane, Suite G7, Preston
 Lancashire, PR1 8UD, U.K.
 Tel 44-1772-556601
 Fax 44-1772-888366
www.belfuse.com

Компания «Океан Электроники» предлагает заключение долгосрочных отношений при поставках импортных электронных компонентов на взаимовыгодных условиях!

Наши преимущества:

- Поставка оригинальных импортных электронных компонентов напрямую с производств Америки, Европы и Азии, а так же с крупнейших складов мира;
- Широкая линейка поставок активных и пассивных импортных электронных компонентов (более 30 млн. наименований);
- Поставка сложных, дефицитных, либо снятых с производства позиций;
- Оперативные сроки поставки под заказ (от 5 рабочих дней);
- Экспресс доставка в любую точку России;
- Помощь Конструкторского Отдела и консультации квалифицированных инженеров;
- Техническая поддержка проекта, помощь в подборе аналогов, поставка прототипов;
- Поставка электронных компонентов под контролем ВП;
- Система менеджмента качества сертифицирована по Международному стандарту ISO 9001;
- При необходимости вся продукция военного и аэрокосмического назначения проходит испытания и сертификацию в лаборатории (по согласованию с заказчиком);
- Поставка специализированных компонентов военного и аэрокосмического уровня качества (Xilinx, Altera, Analog Devices, Intersil, Interpoint, Microsemi, Actel, Aeroflex, Peregrine, VPT, Syfer, Eurofarad, Texas Instruments, MS Kennedy, Miteq, Cobham, E2V, MA-COM, Hittite, Mini-Circuits, General Dynamics и др.);

Компания «Океан Электроники» является официальным дистрибьютором и эксклюзивным представителем в России одного из крупнейших производителей разъемов военного и аэрокосмического назначения «JONHON», а так же официальным дистрибьютором и эксклюзивным представителем в России производителя высокотехнологичных и надежных решений для передачи СВЧ сигналов «FORSTAR».



JONHON

«JONHON» (основан в 1970 г.)

Разъемы специального, военного и аэрокосмического назначения:

(Применяются в военной, авиационной, аэрокосмической, морской, железнодорожной, горно- и нефтедобывающей отраслях промышленности)

«FORSTAR» (основан в 1998 г.)

ВЧ соединители, коаксиальные кабели, кабельные сборки и микроволновые компоненты:

(Применяются в телекоммуникациях гражданского и специального назначения, в средствах связи, РЛС, а так же военной, авиационной и аэрокосмической отраслях промышленности).



Телефон: 8 (812) 309-75-97 (многоканальный)

Факс: 8 (812) 320-03-32

Электронная почта: ocean@oceanchips.ru

Web: <http://oceanchips.ru/>

Адрес: 198099, г. Санкт-Петербург, ул. Калинина, д. 2, корп. 4, лит. А