

B
TSS Series

Slide Switches, Vertical, Single or Dual Actuator

MATERIAL SPECIFICATIONS:

ContactsCopper w/gold plate over nickel
 Case MaterialHigh temperature polyester (94-VO)
 Actuator MaterialPolyester (94-VO)
 TerminalsCopper alloy tin/lead/nickel or gold/nickel
 Terminal SealEpoxy standard: single pole, optional: double pole

TYPICAL PERFORMANCE CHARACTERISTICS:

Contact RatingGold: 0.4 VA max. @ 20 VDC or peak AC
 Initial Contact Resistance20 Milliohms max.
 Contact TimingNon-shorting
 Insulation Resistance1,000 Megohms min. @ 500 VDC
 Dielectric Strength1,000 Volts RMS @ sea level
 Plunger/Actuator Travel0.120" (3.05)
 Life ExpectancyUp to 60,000-80,000 Cycles

ENVIRONMENTAL SPECIFICATIONS:

Operating Temperature-4°F to + 176°F (-20°C to + 80°C)
 Storage Temperature-4°F to + 176°F (-20°C to + 80°C)

SPST/SPDT

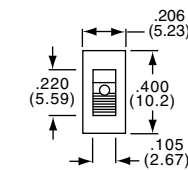

SPST/SPDT (DUAL)

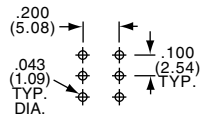
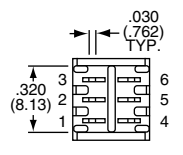
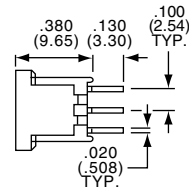

| Extended Actuator Tyco Electronics | Alcoswitch | Type | Act. Code P. M6 | On | None | Off | Extended Dual Actuator Tyco Electronics | Alcoswitch | Type | Act. Code P. M6 | On | None | Off |
|------------------------------------|------------|------|-----------------|----|------|-----|---|-------------|----------|-----------------|----|------|-----|
| 1437578-3 | TSS11AGPC | SPST | A | On | None | Off | — | TSD21AAGPC | 2 x SPST | A | On | None | Off |
| 1-1437589-0 | TSS11DGPC | SPDT | D | On | None | On | 1437579-5 | TSD21DDGPC | 2 x SPDT | D | On | None | On |
| 1-1437579-4 | TSS11EGPC | SPDT | E | On | Off | On | Flush Dual Actuator | | | | | | |
| — | TSS11AG1PC | SPST | A | On | None | Off | — | TSD21DDG1PC | 2 x SPDT | D | On | None | On |
| 1437579-8 | TSS11DG1PC | SPDT | D | On | None | On | | | | | | | |
| 1-1437579-2 | TSS11EG1PC | SPDT | E | On | Off | On | | | | | | | |

Note: No center terminals on "A" action switches.

DPST/DPDT

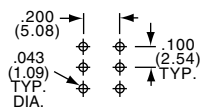
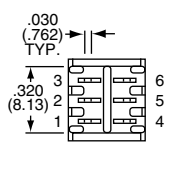
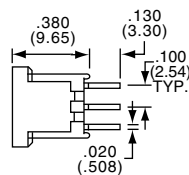
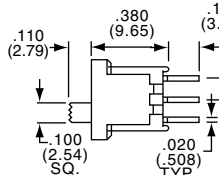

| Extended Actuator Tyco Electronics | Alcoswitch | Type | Act. Code P. M6 | On | None | Off | Flush Actuator Tyco Electronics | Alcoswitch | Act. Code Type | P. M6 | On | None | Off |
|------------------------------------|------------|------|-----------------|----|------|-----|---------------------------------|------------|----------------|-------|----|------|-----|
| 1-1437579-6 | TSS21KGPC | DPST | K | On | None | Off | — | TSS21KG1PC | DPST | K | On | None | Off |
| 1-1437579-9 | TSS21NGPC | DPDT | N | On | None | On | 1-1437579-7 | TSS21NG1PC | DPDT | N | On | None | On |
| 2-1437579-3 | TSS21PGPC | DPDT | P | On | Off | On | 2-1437579-1 | TSD21RG1PC | DPDT | P | On | Off | On |

Note: No center terminals on "K" action switches.

4PDT

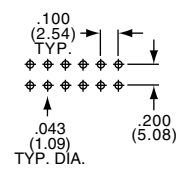
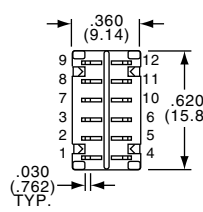
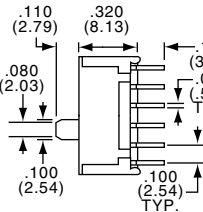

| Extended Actuator Tyco Electronics | Alcoswitch | Type | Act. Code P. M6 | On | None | Off |
|------------------------------------|------------|------|-----------------|----|------|-----|
| 2-1437579-5 | TSS41NGPC | 4PDT | N | On | None | On |

Slide Switches, Right Angle, Single or Dual Actuator

SEE PAGE B18 FOR PRODUCT SPECIFICATIONS

SPDT



| Extended Actuator | | | Act. Code | | | Flush Actuator | | | Act. Code | | | |
|-------------------|------------|------|-----------|----|------|------------------|------------|------|-----------|----|------|----|
| Tyco Electronics | Alcoswitch | Type | P. M6 | On | None | Tyco Electronics | Alcoswitch | Type | P. M6 | On | None | On |
| 1-1437579-1 | TSS11DGRA | SPDT | D | On | None | 1437579-9 | TSS11DG1RA | SPDT | D | On | None | On |
| 1-1437579-5 | TSS11EGRA | SPDT | E | On | Off | 1-1437579-3 | TSS11EG1RA | SPDT | E | On | Off | On |

SPDT (DUAL)

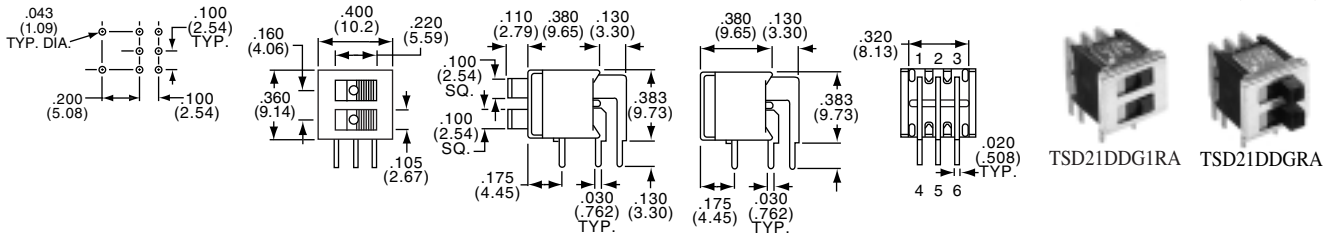

| Extended Actuator | | | Act. Code | | | Flush Actuator | | | Act. Code | | | |
|-------------------|------------|----------|-----------|----|------|------------------|-------------|----------|-----------|----|------|----|
| Tyco Electronics | Alcoswitch | Type | P. M6 | On | None | Tyco Electronics | Alcoswitch | Type | P. M6 | On | None | On |
| 1437579-6 | TSD21DDGRA | 2 x SPDT | D | On | None | 1437579-4 | TSD21DDG1RA | 2 x SPDT | D | On | None | On |
| 1437579-7 | TSD21EEGRA | 2 x SPDT | E | On | Off | — | TSD21EEG1RA | 2 x SPDT | E | On | Off | On |

DPDT

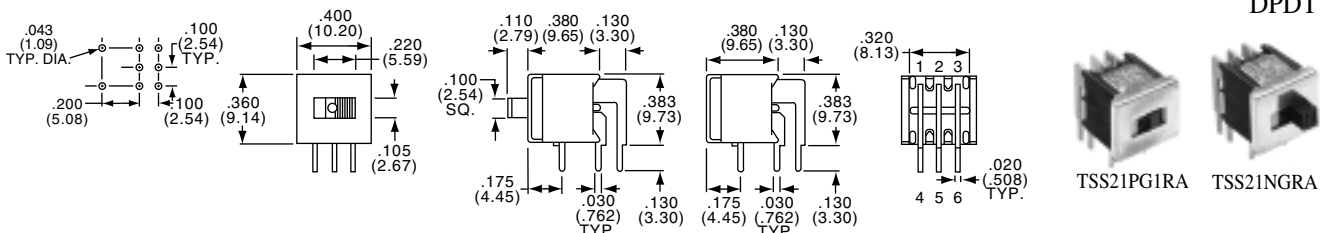

| Extended Actuator | | | Act. Code | | | Flush Actuator | | | Act. Code | | | |
|-------------------|------------|------|-----------|----|------|------------------|------------|------|-----------|----|------|----|
| Tyco Electronics | Alcoswitch | Type | P. M6 | On | None | Tyco Electronics | Alcoswitch | Type | P. M6 | On | None | On |
| — | TSS21PAGRA | SP3T | PA | On | On | — | TSS21NG1RA | DPDT | N | On | None | On |
| 2-1437579-0 | TSS21NGRA | DPDT | N | On | None | — | TSS21PG1RA | DPDT | P | On | Off | On |
| 2-1437579-4 | TSS21PGRA | DPDT | P | On | Off | — | — | — | — | — | — | — |

4PDT

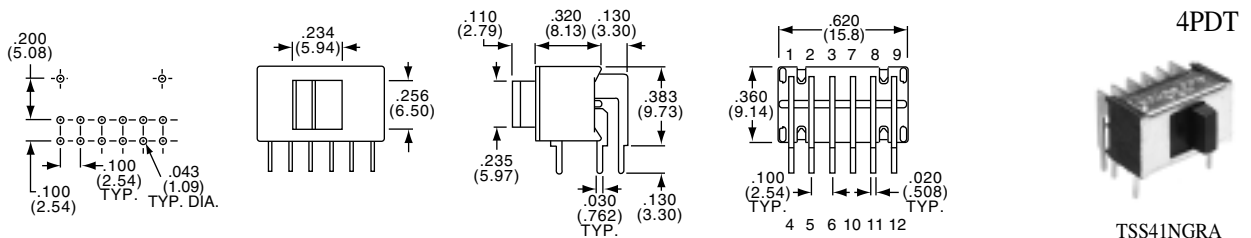

| Extended Actuator | | | Act. Code | | | |
|-------------------|------------|------|-----------|----|------|----|
| Tyco Electronics | Alcoswitch | Type | P. M6 | On | None | On |
| 2-1437579-7 | TSS41NGRA | 4PDT | N | On | None | On |

Slide Switches, Instrumentation Grade

MATERIAL SPECIFICATIONS:

ContactsGold or silver over nickel/copper alloy
 Frame MaterialTin plated steel
 Terminals/Fixed Contacts.....Gold or silver over nickel/over copper alloy
 Terminal SealEpoxy
 Actuator MaterialPOM-UL94HB

ENVIRONMENTAL SPECIFICATIONS:

Operating Temperature.....-4°F to +185°F (-20°C to +85°C)
 Storage Temperature.....-40°F to +212°F (-40°C to +100°C)
 Solder Heat ResistanceSee page M3-4

TYPICAL PERFORMANCE CHARACTERISTICS:

Contact RatingGold: 0.4 VA 20 VDC or peak AC
 Silver: 300 mA @ 125 VAC
 Initial Contact Resistance20 Milliohms max.
 Contact TimingMake before break
 Insulation Resistance1,000 Megohms min.
 Dielectric Strength500 VAC
 Actuation Force100 to 600 Grams
 Life ExpectancyUp to 15,000 Cycles
 Travel0.079" (2.01) (unless otherwise specified)

B
MSS Series

SPDT



MSS1200



MSS1200R



| Tyco Electronics | Alcoswitch | Plating | Tyco Electronics | Alcoswitch | Plating |
|------------------|------------|---------|------------------|------------|---------|
| 5-1437576-0 | MSS1200 | Silver | 5-1437576-2 | MSS1200R | Silver |
| 5-1437576-1 | MSS1200G | Gold | 5-1437576-3 | MSS1200RG | Gold |

SP3T



MSS1300



MSS1300R



| Tyco Electronics | Alcoswitch | Plating | Tyco Electronics | Alcoswitch | Plating | Total Actuator Travel |
|------------------|------------|---------|------------------|------------|---------|-----------------------|
| 5-1437576-4 | MSS1300 | Silver | 5-1437576-6 | MSS1300R | Silver | .098(2.50) |
| 5-1437576-5 | MSS1300G | Gold | 5-1437576-7 | MSS1300RG | Gold | .098(2.50) |

Slide Switches, Instrumentation Grade

SEE PAGE B20 FOR PRODUCT SPECIFICATIONS



SP4T

MSS1400

| Tyco Electronics | Alcoswitch | Plating |
|------------------|------------|---------|
| 5-1437576-8 | MSS1400 | Silver |
| 1571423-1 | MSS1400G | Gold |

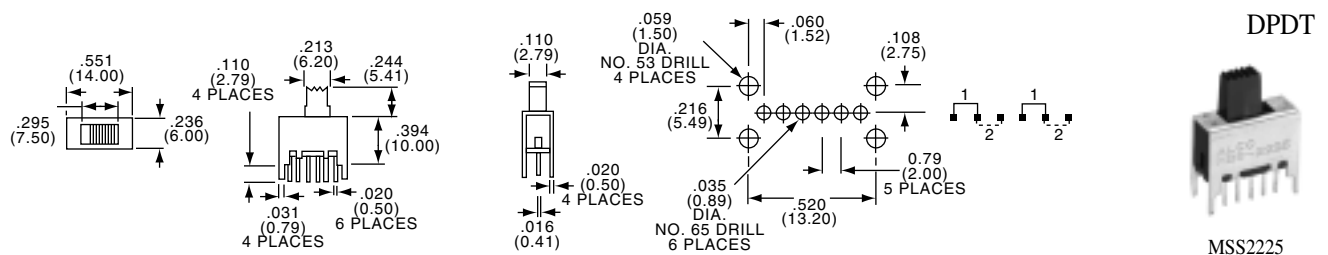

DPDT

MSS2225

| Tyco Electronics | Alcoswitch | Plating |
|------------------|------------|---------|
| 6-1437576-3 | MSS2225 | Silver |
| 6-1437576-4 | MSS2225G | Gold |

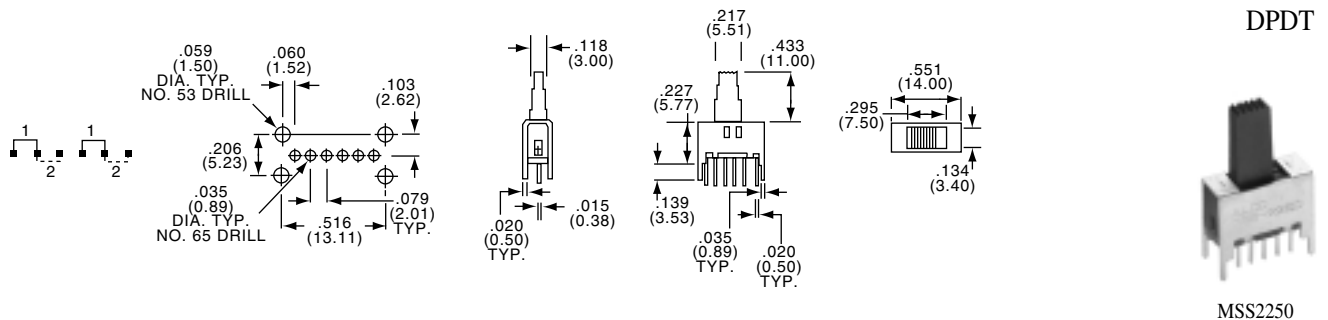

DPDT

MSS2250

| Tyco Electronics | Alcoswitch | Plating |
|------------------|------------|---------|
| 6-1437576-5 | MSS2250 | Silver |
| 6-1437576-6 | MSS2250G | Gold |

Slide Switches, Instrumentation Grade

DPDT



MSS2250R

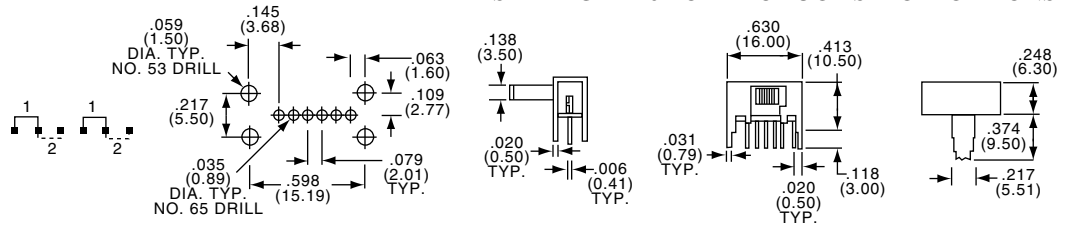

SEE PAGE B20 FOR PRODUCT SPECIFICATIONS

| Tyco Electronics | Alcoswitch | Plating |
|------------------|------------|---------|
| 6-1437576-7 | MSS2250R | Silver |
| 6-1437576-8 | MSS2250RG | Gold |

4PDT



MSS4200

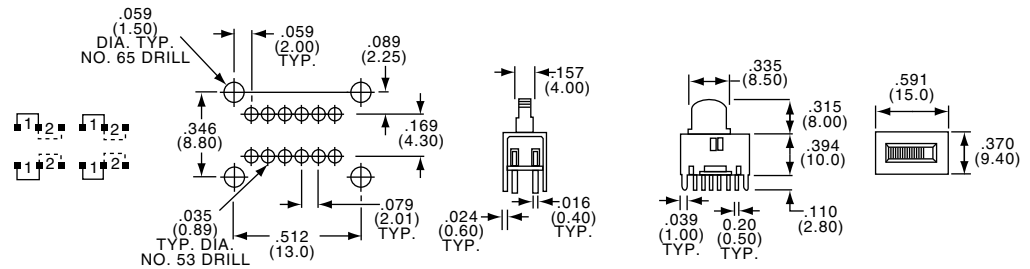

| Tyco Electronics | Alcoswitch | Plating |
|------------------|------------|---------|
| 6-1437576-9 | MSS4200 | Silver |
| 7-1437576-0 | MSS4200G | Gold |

4PDT



MSS4250

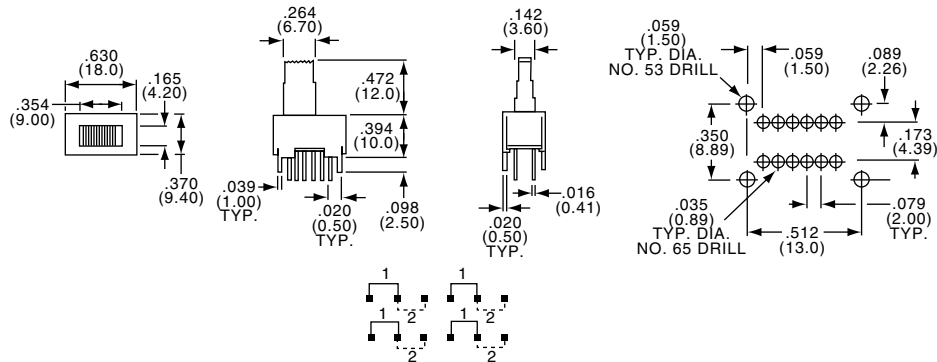

| Tyco Electronics | Alcoswitch | Plating |
|------------------|------------|---------|
| 7-1437576-4 | MSS4250 | Silver |

Slide Switches, Instrumentation Grade

SEE PAGE B20 FOR PRODUCT SPECIFICATIONS



4PDT



MSS4200R

| Tyco Electronics | Alcoswitch | Plating |
|------------------|------------|---------|
| 7-1437576-2 | MSS4200R | Silver |
| 7-1437576-3 | MSS4200RG | Gold |



4P3T



MSS4300

| Tyco Electronics | Alcoswitch | Plating |
|------------------|------------|---------|
| 7-1437576-5 | MSS4300 | Silver |
| 7-1437576-6 | MSS4300G | Gold |

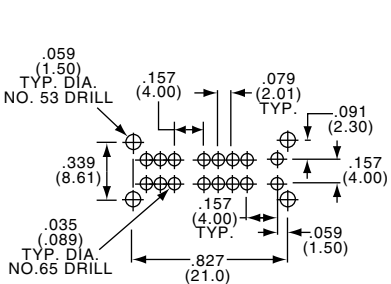
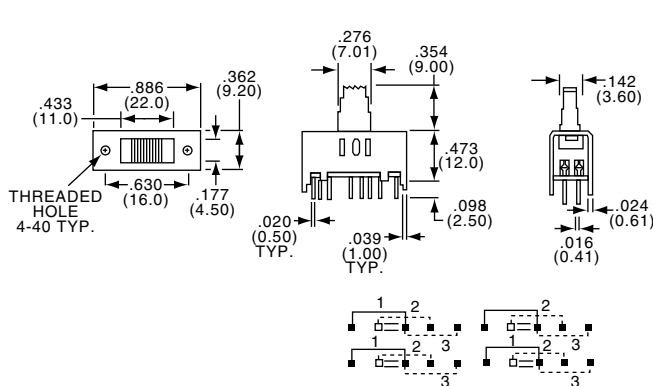

4P3T



MSS4335

| Tyco Electronics | Alcoswitch | Plating |
|------------------|------------|---------|
| 7-1437576-9 | MSS4335 | Silver |

Компания «Океан Электроники» предлагает заключение долгосрочных отношений при поставках импортных электронных компонентов на взаимовыгодных условиях!

Наши преимущества:

- Поставка оригинальных импортных электронных компонентов напрямую с производств Америки, Европы и Азии, а так же с крупнейших складов мира;
- Широкая линейка поставок активных и пассивных импортных электронных компонентов (более 30 млн. наименований);
- Поставка сложных, дефицитных, либо снятых с производства позиций;
- Оперативные сроки поставки под заказ (от 5 рабочих дней);
- Экспресс доставка в любую точку России;
- Помощь Конструкторского Отдела и консультации квалифицированных инженеров;
- Техническая поддержка проекта, помощь в подборе аналогов, поставка прототипов;
- Поставка электронных компонентов под контролем ВП;
- Система менеджмента качества сертифицирована по Международному стандарту ISO 9001;
- При необходимости вся продукция военного и аэрокосмического назначения проходит испытания и сертификацию в лаборатории (по согласованию с заказчиком);
- Поставка специализированных компонентов военного и аэрокосмического уровня качества (Xilinx, Altera, Analog Devices, Intersil, Interpoint, Microsemi, Actel, Aeroflex, Peregrine, VPT, Syfer, Eurofarad, Texas Instruments, MS Kennedy, Miteq, Cobham, E2V, MA-COM, Hittite, Mini-Circuits, General Dynamics и др.);

Компания «Океан Электроники» является официальным дистрибьютором и эксклюзивным представителем в России одного из крупнейших производителей разъемов военного и аэрокосмического назначения «JONHON», а так же официальным дистрибьютором и эксклюзивным представителем в России производителя высокотехнологичных и надежных решений для передачи СВЧ сигналов «FORSTAR».



JONHON

«JONHON» (основан в 1970 г.)

Разъемы специального, военного и аэрокосмического назначения:

(Применяются в военной, авиационной, аэрокосмической, морской, железнодорожной, горно- и нефтедобывающей отраслях промышленности)

«FORSTAR» (основан в 1998 г.)

ВЧ соединители, коаксиальные кабели,
кабельные сборки и микроволновые компоненты:

(Применяются в телекоммуникациях гражданского и специального назначения, в средствах связи, РЛС, а так же военной, авиационной и аэрокосмической отраслях промышленности).



Телефон: 8 (812) 309-75-97 (многоканальный)

Факс: 8 (812) 320-03-32

Электронная почта: ocean@oceanchips.ru

Web: <http://oceanchips.ru/>

Адрес: 198099, г. Санкт-Петербург, ул. Калинина, д. 2, корп. 4, лит. А