

### Applications

- General Purpose Wideband Gain Block
- Electronic Warfare
- Military & Commercial Radar
- Military Communications
- Commercial Communications
- Instrumentation

### Product Features

- Frequency Range: 2 – 30 GHz
- Small Signal Gain: 11.5 dB mid-band
- Return Loss: >9 dB
- NF: 3.4 dB typical
- P1dB: 8 dBm,  $P_{SAT} = 12$  dBm at  $P_{IN} = 5$  dBm
- OTOI: 17 dBm at  $P_{out}/tone = 5$  dBm
- Bias:  $V^+ = 5$  V ( $V_D = 3$  V),  $I_{DQ} = 50$  mA,  $V_G = -1.5$  V Typical,  $V_{CTRL} = 0$  V
- Package Dimensions: 5 x 5 x 1.5 mm

### General Description

TriQuint's TGA3504-SM is a packaged wideband gain block with adjustable gain control giving the user extra flexibility to fine tune system performance. Operating from 2 to 30 GHz, the TGA3504-SM provides 8 dBm P1dB and 11 dB of small signal gain with return losses of greater than 9 dB.

The TGA3504-SM is fabricated on TriQuint's TQPHT15 0.15  $\mu$ m GaAs pHEMT process and is offered in a robust 5x5 mm air-cavity QFN. With integrated DC blocking caps and fully matched to 50ohms, the TGA3503-SM is easily integrated in both commercial and military system architectures.

Lead-free and RoHS compliant

Evaluation Boards are available upon request.

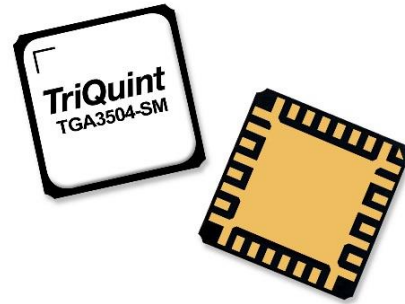

### Functional Block Diagram

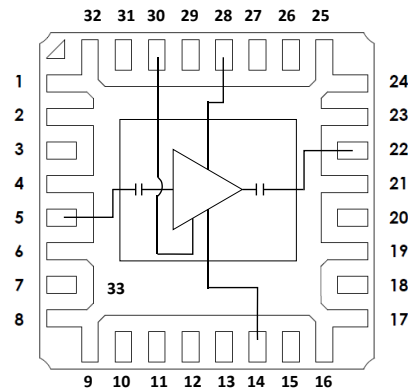

### Pad Configuration

Pad No.	Symbol
1-4, 6-13, 15-21, 23-27, 29, 31-32	Gnd
5	RF <sub>IN</sub>
14	V <sub>G1</sub>
22	RF <sub>OUT</sub>
28	V <sup>+</sup>
30	V <sub>CTRL</sub>
33	Gnd

### Ordering Information

Part	ECCN	Description
TGA3504-SM	EAR99	2 – 30 GHz GaAs Wideband Gain Block

### Absolute Maximum Ratings

Parameter	Value (1)
Bias Voltage ( $V^+$ )	10 V
Drain Voltage ( $V_D$ )	6 V
Gate Voltage Range ( $V_{G1}$ )	-5 to 0 V
Control Voltage Range ( $V_{CTRL}$ )	-1 to 3.9 V (2)
Drain Current ( $I_D$ )	72 mA
Gate Current ( $I_G$ )	-10 to 19 mA
Control Current ( $I_{CTRL}$ )	-0.5 to 16 mA
Power Dissipation, 85 °C ( $P_{DISS}$ )	1.3 W
Input Power, CW, 50 $\Omega$ , ( $P_{IN}$ )	13 dBm
Channel temperature ( $T_{CH}$ )	200 °C
Mounting Temperature (30 Seconds)	260 °C
Storage Temperature	-55 to 150 °C

Notes:

1. Operation of this device outside the parameter ranges given above may cause permanent damage. These are stress ratings only, and functional operation of the device at these conditions is not implied.
2. Assure  $V_D - V_{CTRL} \leq 8$  V. Compute  $V_D = V^+ - I_{DQ} \cdot 40$

### Recommended Operating Conditions

Parameter	Value (1)
Supply Voltage ( $V^+$ )	5 V
Drain Voltage ( $V_D$ )	3 V
Drain Current ( $I_{DQ}$ )	50 mA
Gate Voltage ( $V_{G1}$ )	-1.5 V Typical
Control Voltage ( $V_{CTRL}$ )	0 V
Temperature ( $T_{BASE}$ )	-40 to 85 °C

Notes:

1. Electrical specifications are measured at specified test conditions. Specifications are not guaranteed overall operating conditions

### Electrical Specifications

Test conditions unless otherwise noted: 25 °C,  $V^+ = 5$  V,  $I_{DQ} = 50$  mA,  $V_{G1} = -1.5$  V Typical,  $V_{CTRL} = 0$  V, CW

Parameter	Min	Typical	Max	Units
Operational Frequency Range	2		30	GHz
Small Signal Gain		>10		dB
Input Return Loss		>9		dB
Output Return Loss		>9		dB
Noise Figure		3.4		dB
Output Power at 1 dB Gain Compression		10		dBm
Output TOI at Pout/tone = 5 dBm		17		dBm

### Thermal and Reliability Information

Parameter	Test Conditions	Value	Units
Thermal Resistance ( $\theta_{JC}$ ) <sup>(1)</sup>	$T_{base} = 85\text{ }^{\circ}\text{C}$ , $V_{+} = 5\text{ V}$ $V_D = 3\text{ V}$ , $V_{CTRL} = 0\text{ V}$ , $I_{DQ} = 50\text{ mA}$ , $P_{DISS} = 0.21\text{ W}$	48	$^{\circ}\text{C/W}$
Channel Temperature ( $T_{CH}$ ) (No RF drive)		95	$^{\circ}\text{C}$
Median Lifetime ( $T_M$ )		$1.2 \times 10^9$	Hrs
Thermal Resistance ( $\theta_{JC}$ ) <sup>(1)</sup>	$T_{base} = 85\text{ }^{\circ}\text{C}$ , $V_{+} = 5\text{ V (CW)}$ $V_D = 3\text{ V}$ , $V_{CTRL} = 0\text{ V}$ , $I_{DQ} = 50\text{ mA}$ , $I_{D\_Drive} = 58\text{ mA}$ $P_{IN} = 5\text{ dBm}$ , $P_{OUT} = 11\text{ dBm}$ , $\text{Freq} = 16\text{ GHz}$ , $P_{DISS} = 0.16\text{ W}$	42	$^{\circ}\text{C/W}$
Channel Temperature ( $T_{CH}$ ) (Under RF drive)		92	$^{\circ}\text{C}$
Median Lifetime ( $T_M$ )		$1.8 \times 10^9$	Hrs

Notes:

1. Thermal resistance measured at back of the package.

Test Conditions:  $V_D = 6\text{ V}$ ; Failure Criteria is 10% reduction in  $I_{D\_MAX}$

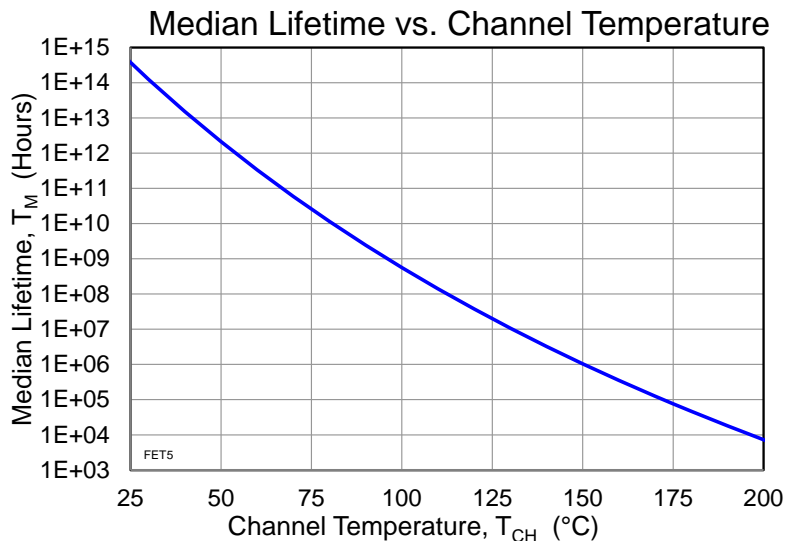

### Typical Performance: Small Signal

Conditions unless otherwise specified:  $V^+ = 5\text{ V}$ ,  $I_{DQ} = 50\text{ mA}$ ,  $V_{G1} = -1.5\text{ V}$  Typical,  $V_{CTRL} = 0\text{ V}$ , CW

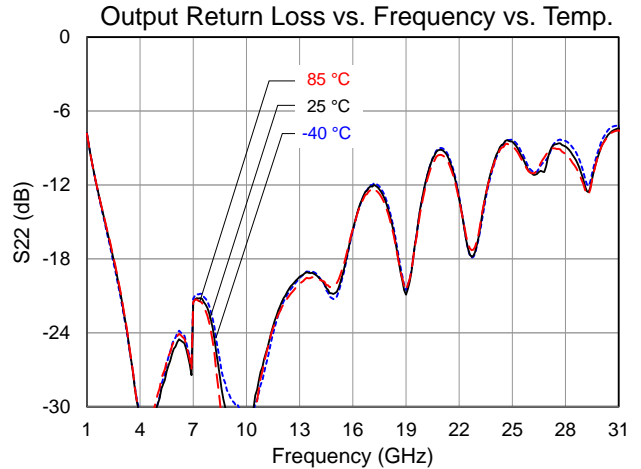
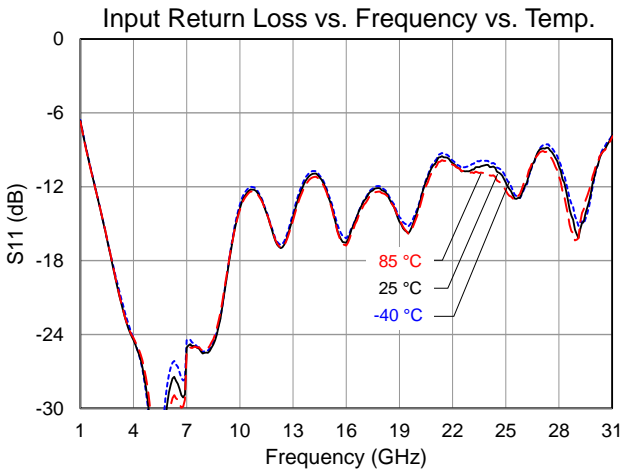
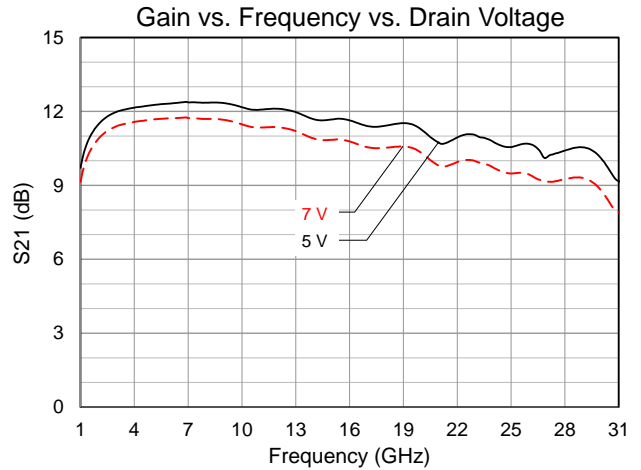
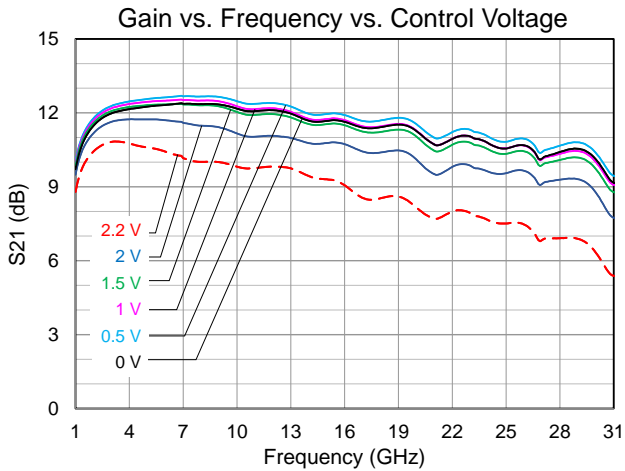
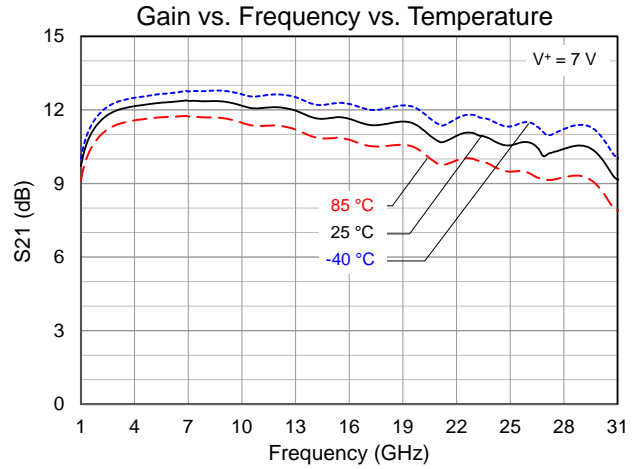
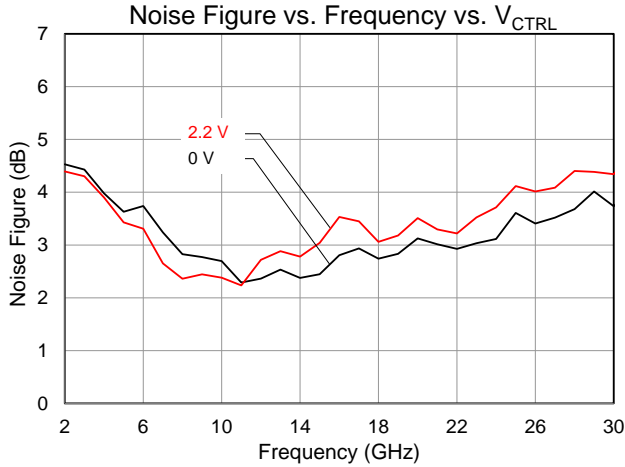

### Typical Performance: Large Signal

Conditions unless otherwise specified:  $V^+ = 5\text{ V}$ ,  $I_{DQ} = 50\text{ mA}$ ,  $V_{G1} = -1.5\text{ V}$  Typical,  $V_{CTRL} = 0\text{ V}$ , CW

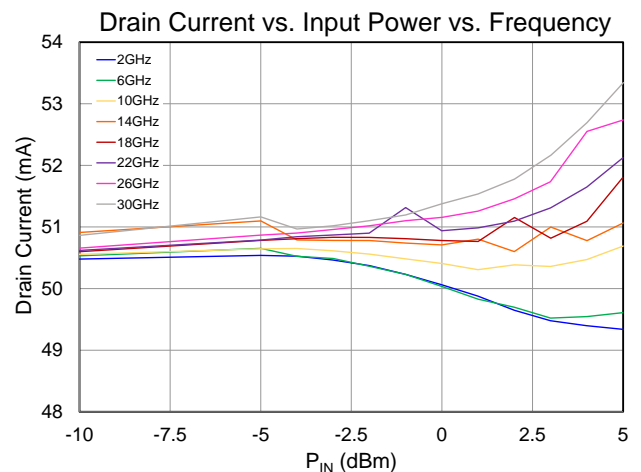
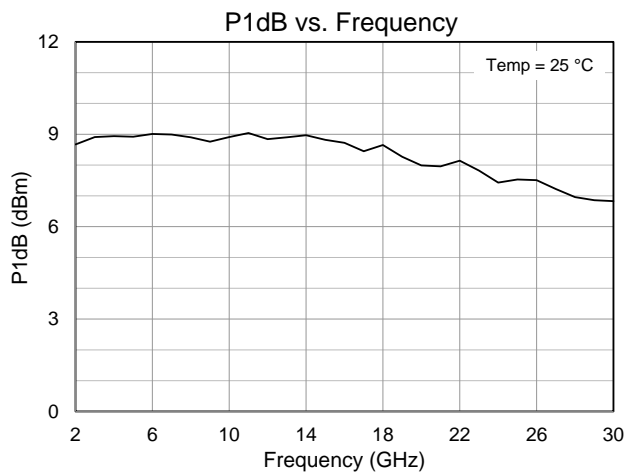
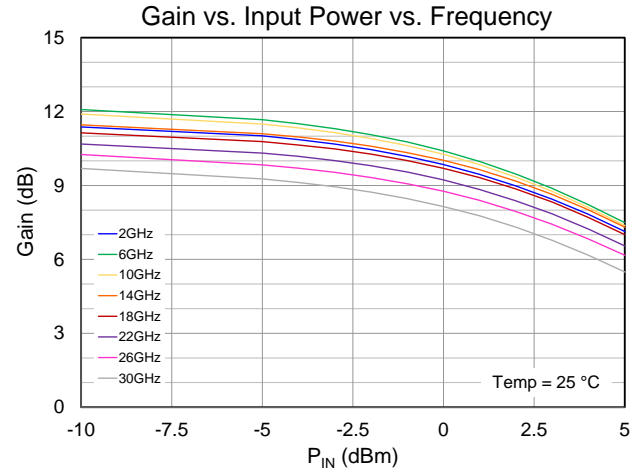
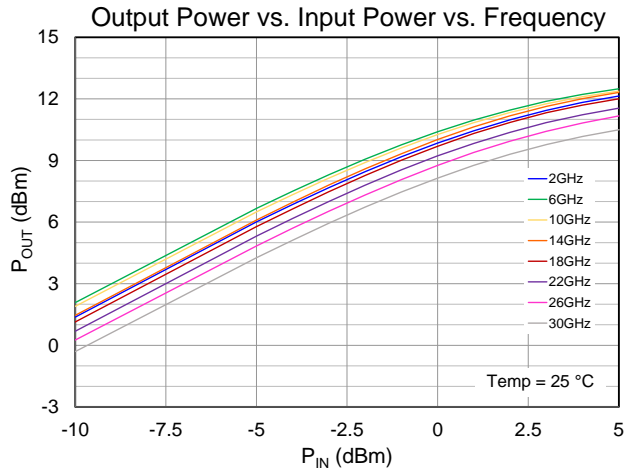

### Typical Performance: Linearity

Conditions unless otherwise specified:  $V^+ = 5\text{ V}$ ,  $I_{DQ} = 50\text{ mA}$ ,  $V_{G1} = -1.5\text{ V}$  Typical,  $V_{CTRL} = 0\text{ V}$ , CW

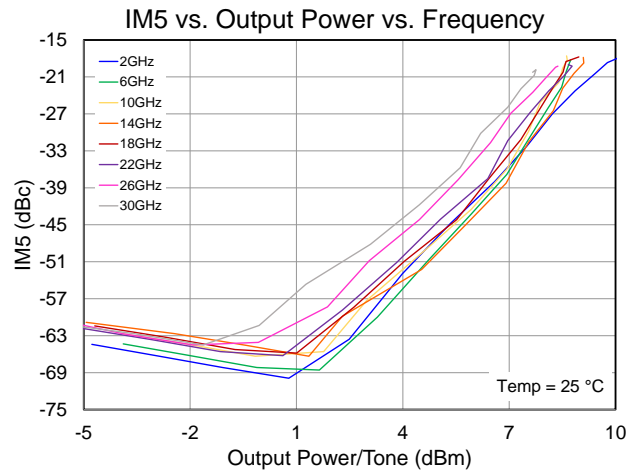
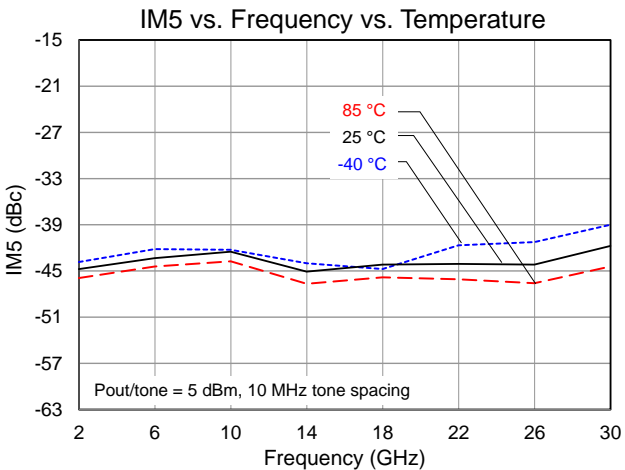
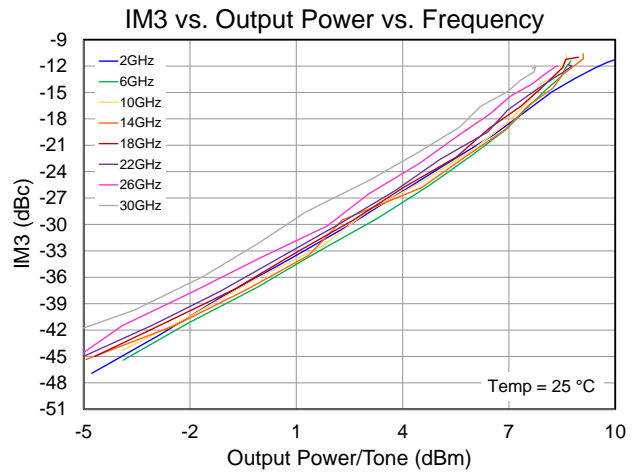
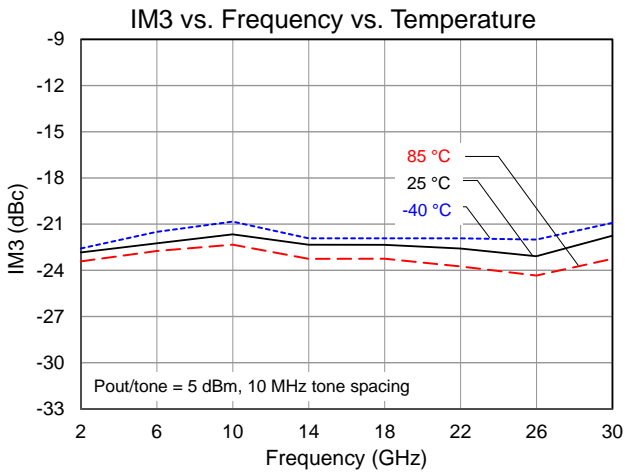
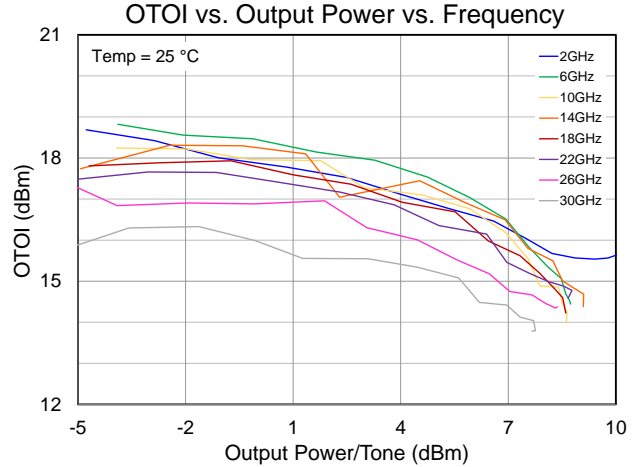
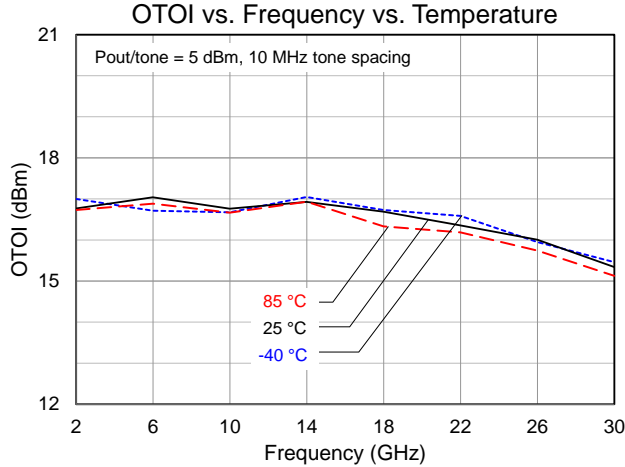

### Application Information

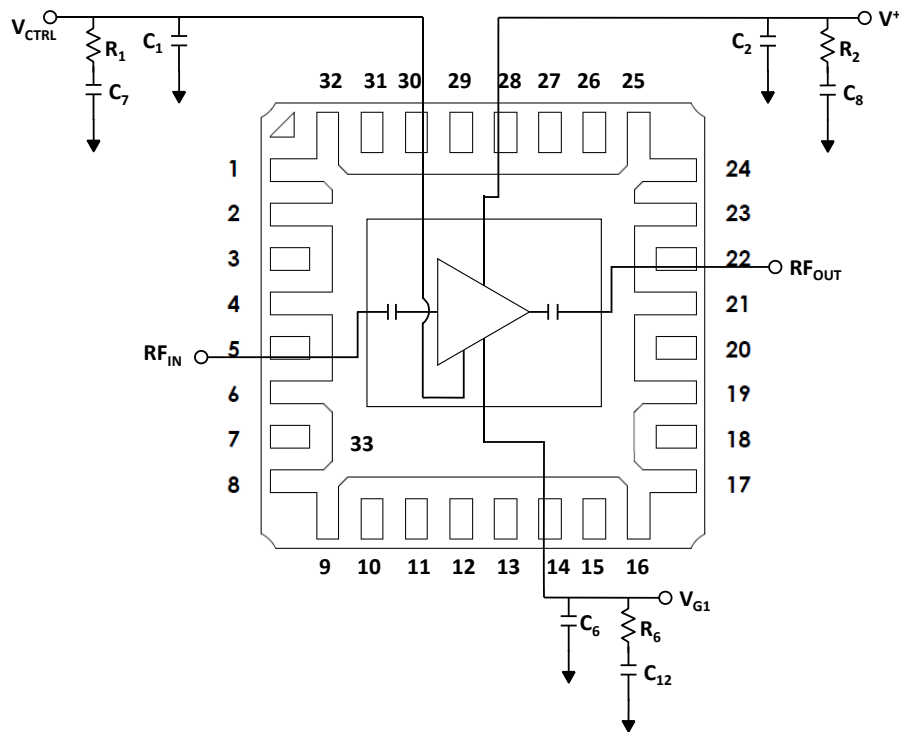

### Bias-up Procedure

1. Set  $I_D$  limit to 72 mA,  $I_G$  limit to 10 mA
2. Apply -2 V to  $V_{G1}$  for pinch off
3. Apply desired value to  $V_{CTRL}$
4. Apply +5 V to  $V_+$ , resulting in  $V_D = 3$  V
5. Adjust  $V_{G1}$  more positive until  $I_{DQ} = 50$  mA ( $V_G \sim -1.5$  V Typical)
6. Apply Gain Control signal ( $V_{CTRL}$ )
7. Apply RF signal

### Bias-down Procedure

1. Turn off RF signal
2. Reduce  $V_{G1}$  to -2 V. Ensure  $I_{DQ} \sim 0$  mA
3. Set  $V_+$  to 0 V
4. Turn off  $V_{CTRL}$  supply
5. Turn off  $V_D$  supply
6. Turn off  $V_{G1}$  supply

### Pin Description

Pin No.	Symbol	Description
1-4, 6-13, 15-21, 23-27, 29, 31-32	Gnd	Recommend grounding on PCB
5	RF <sub>IN</sub>	Input; matched to 50 Ω; DC blocked
14	$V_{G1}$	Gate voltage; bias network is required; see recommended Application Information above.
22	RF <sub>OUT</sub>	Output; matched to 50 Ω; DC blocked
28	$V_+$	Drain voltage; bias network is required; see recommended Application Information above.
30	$V_{CTRL}$	Gain control voltage; bias network is required; see recommended Application Information above.

## Evaluation Board

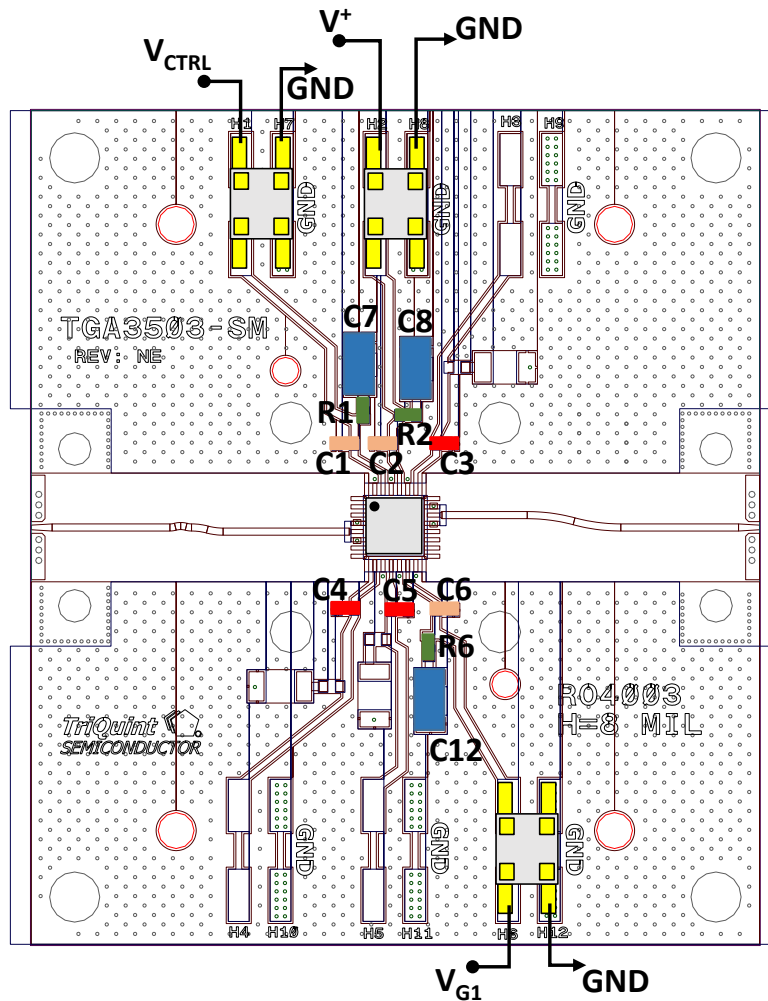

## Bill of Material

Reference Des.	Value	Description	Manuf.	Part Number
C1, C2, C6	1 $\mu$ F	Cap, 0402, 50 V, 10%, X7R	Various	
C3, C4, C5	0 Ohms	Res, 0402, 5% (Required for above EVB design)	Various	
C7, C8, C12	2.2 $\mu$ F	Res, 1206, 50 V, 10%, X7R	Various	
R1, R2, R6	15 Ohms	Res, 0402, 50 V, 5%	Various	



**Mechanical Information**

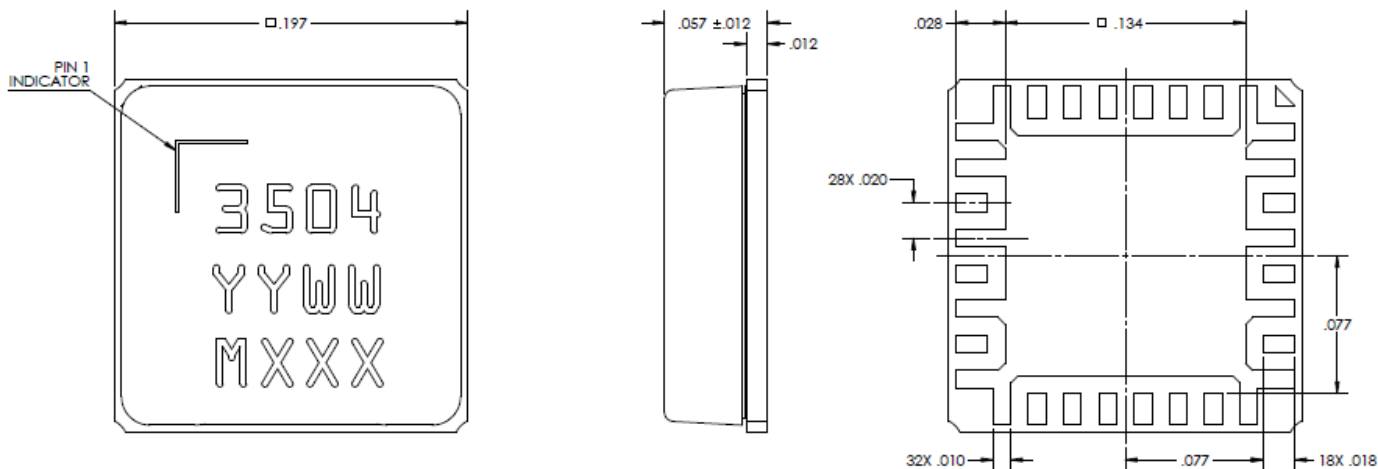

Units: inches

Tolerances: unless specified

x.xx = ± 0.01

x.xxx = ± 0.005

Materials:

Base: Aluminum Nitride

All metalized features are Au plated

Part is mold encapsulated

Marking:

3504: Part number

YY: Part Assembly year

WW: Part Assembly week

MXXX: Batch ID

**Recommended Soldering Temperature Profile**

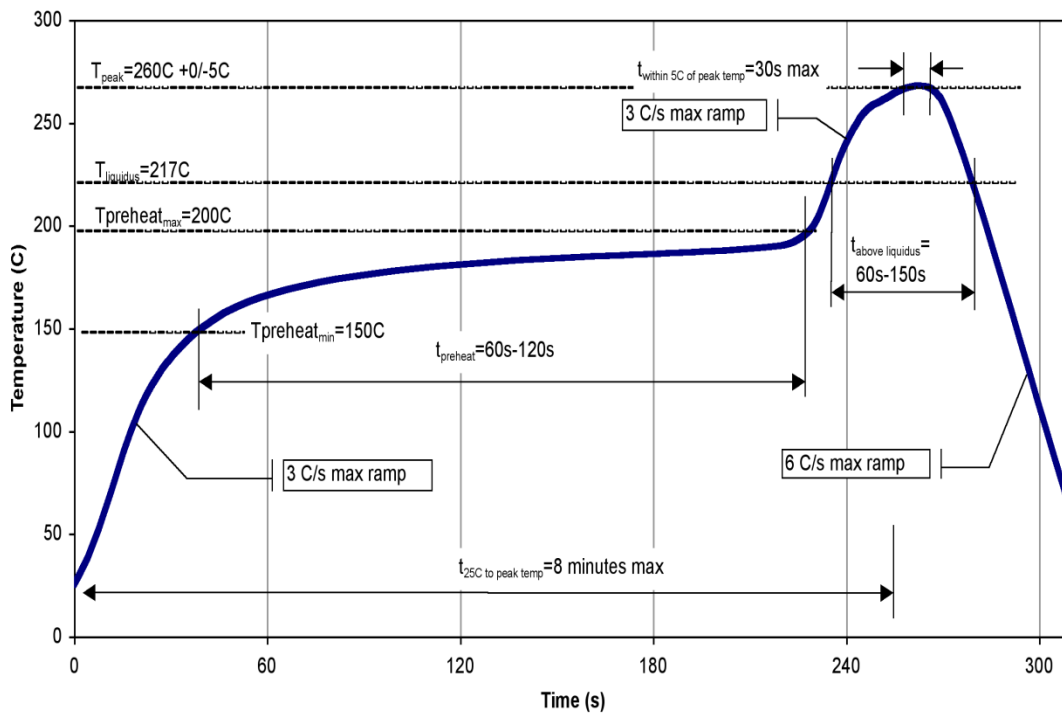

## ESD Sensitivity Ratings



Caution! ESD-Sensitive Device

ESD Rating: TBD  
Value: TBD  
Test: Human Body Model (HBM)  
Standard: JEDEC Standard JESD22-A114

## MSL Rating

Level TBD at TBD°C convection reflow  
The part is rated Moisture Sensitivity Level TBD at TBD°C per JEDEC standard IPC/JEDEC J-STD-020.

## ECCN

US Department of Commerce: EAR99

## Solderability

Compatible with the latest version of J-STD-020 Lead-free solder, 260 °C.

## RoHS Compliance

This part is compliant with EU 2002/95/EC RoHS directive (Restrictions on the Use of Certain Hazardous Substances in Electrical and Electronic Equipment).

This product also has the following attributes:

- Lead Free
- Halogen Free (Chlorine, Bromine)
- Antimony Free
- TBBP-A (C<sub>15</sub>H<sub>12</sub>Br<sub>4</sub>O<sub>2</sub>) Free
- PFOS Free
- SVHC Free

## Contact Information

For the latest specifications, additional product information, worldwide sales and distribution locations, and information about TriQuint:

Web: [www.triquint.com](http://www.triquint.com)  
Email: [info-sales@triquint.com](mailto:info-sales@triquint.com)

Tel: +1.972.994.8465  
Fax: +1.972.994.8504

For technical questions and application information: Email: [info-products@triquint.com](mailto:info-products@triquint.com)

## Important Notice

The information contained herein is believed to be reliable. TriQuint makes no warranties regarding the information contained herein. TriQuint assumes no responsibility or liability whatsoever for any of the information contained herein. TriQuint assumes no responsibility or liability whatsoever for the use of the information contained herein. The information contained herein is provided "AS IS, WHERE IS" and with all faults, and the entire risk associated with such information is entirely with the user. All information contained herein is subject to change without notice. Customers should obtain and verify the latest relevant information before placing orders for TriQuint products. The information contained herein or any use of such information does not grant, explicitly or implicitly, to any party any patent rights, licenses, or any other intellectual property rights, whether with regard to such information itself or anything described by such information.

TriQuint products are not warranted or authorized for use as critical components in medical, life-saving, or life-sustaining applications, or other applications where a failure would reasonably be expected to cause severe personal injury or death.

Компания «Океан Электроники» предлагает заключение долгосрочных отношений при поставках импортных электронных компонентов на взаимовыгодных условиях!

Наши преимущества:

- Поставка оригинальных импортных электронных компонентов напрямую с производств Америки, Европы и Азии, а так же с крупнейших складов мира;
- Широкая линейка поставок активных и пассивных импортных электронных компонентов (более 30 млн. наименований);
- Поставка сложных, дефицитных, либо снятых с производства позиций;
- Оперативные сроки поставки под заказ (от 5 рабочих дней);
- Экспресс доставка в любую точку России;
- Помощь Конструкторского Отдела и консультации квалифицированных инженеров;
- Техническая поддержка проекта, помощь в подборе аналогов, поставка прототипов;
- Поставка электронных компонентов под контролем ВП;
- Система менеджмента качества сертифицирована по Международному стандарту ISO 9001;
- При необходимости вся продукция военного и аэрокосмического назначения проходит испытания и сертификацию в лаборатории (по согласованию с заказчиком);
- Поставка специализированных компонентов военного и аэрокосмического уровня качества (Xilinx, Altera, Analog Devices, Intersil, Interpoint, Microsemi, Actel, Aeroflex, Peregrine, VPT, Syfer, Eurofarad, Texas Instruments, MS Kennedy, Miteq, Cobham, E2V, MA-COM, Hittite, Mini-Circuits, General Dynamics и др.);

Компания «Океан Электроники» является официальным дистрибьютором и эксклюзивным представителем в России одного из крупнейших производителей разъемов военного и аэрокосмического назначения «JONHON», а так же официальным дистрибьютором и эксклюзивным представителем в России производителя высокотехнологичных и надежных решений для передачи СВЧ сигналов «FORSTAR».



## JONHON

«JONHON» (основан в 1970 г.)

Разъемы специального, военного и аэрокосмического назначения:

(Применяются в военной, авиационной, аэрокосмической, морской, железнодорожной, горно- и нефтедобывающей отраслях промышленности)

«FORSTAR» (основан в 1998 г.)

ВЧ соединители, коаксиальные кабели, кабельные сборки и микроволновые компоненты:

(Применяются в телекоммуникациях гражданского и специального назначения, в средствах связи, РЛС, а так же военной, авиационной и аэрокосмической отраслях промышленности).



Телефон: 8 (812) 309-75-97 (многоканальный)

Факс: 8 (812) 320-03-32

Электронная почта: [ocean@oceanchips.ru](mailto:ocean@oceanchips.ru)

Web: <http://oceanchips.ru/>

Адрес: 198099, г. Санкт-Петербург, ул. Калинина, д. 2, корп. 4, лит. А