

General Description

The MAX40008/MAX40009 evaluation kit (EV kit) is a fully assembled and tested PC board that evaluates the MAX40008/MAX40009 single comparator with shutdown input. The MAX40009EVKIT# comes with a push-pull output (MAX40009ANT+), while the MAX40008EVKIT# EV kit comes with an open-drain output (MAX40008ANT+) installed that operates off a V_{DD} supply between 1.7V and 5.5V. The MAX40008/MAX40009 has a wide input common mode voltage range from -0.2V to $V_{DD} + 0.2V$. This EV kit demonstrates the MAX40008/MAX40009 in an ultra-small, 0.73mm x 1.1mm, 6-bump wafer-level package (WLP) with 0.35mm bump spacing.

The EV kit can be used to evaluate both the MAX40008 and MAX40009 with a 6-bump WLP. To evaluate the MAX40008 (open-drain output version on MAX40009EVKIT#), replace U1 (MAX40009) with the MAX40008 with jumper J1 installed.

When using the MAX40008EVKIT# to evaluate the MAX40009 (push-pull version), replace U1 (MAX40008) with MAX40009 with jumper J1 removed.

Features

- 300ns Propagation Delay
- Wide Input Common Mode Voltage Range, -0.2V to $V_{DD} + 0.2V$
- Hysteresis Adding Configurable
- Evaluates 6-Bump WLP Package
- Fully Assembled and Tested

[Ordering Information](#) appears at end of data sheet.

Quick Start

Required Equipment

- Three +5V DC power supplies (V_{DD} , V_{IN+} , and V_{PULL})
- Two digital multimeters (DMMs)

Procedure

The MAX40008/MAX40009 EV kit is fully assembled and tested. Follow steps below to verify board operation. **Caution: Do not turn on the power supply until all connections are completed.**

- 1) Connect the positive terminal of a DC power supply to the VDD test point and the ground terminal to the GND test point.
- 2) Connect the positive terminal of a DC power supply to the VPULL test point and the ground terminal to the GND test point when evaluating the MAX40008. This is not necessary when evaluating the MAX40009.
- 3) Connect the positive terminal of a DC power supply to the INP test point and the ground terminal to the GND test point.
- 4) Turn on the V_{DD} power supply and set it to any voltage between 1.7V and 5.5V.
- 5) Turn on the V_{PULL} power supply and set it to any voltage between 1.7V to 5.5V (MAX40008 only). Do not need V_{PULL} supply when MAX40009 (push-pull output) is used.
- 6) Turn on the $IN+$ power supply and set it to the desired level.
- 7) Monitor the output using a DMM at the V_{OUT} test point and observe its response to varying voltage at $IN+$. V_{OUT} should be at logic-high (V_{PULL}) when voltage applied on $IN+$ is greater than V_{IN-} and should be at logic-low (0V) when the voltage applied on $IN+$ is less than V_{IN-} .

Detailed Description of Hardware

The MAX40008/MAX40009 EV kit is a fully assembled and tested PC board that evaluates the 6-bump WLP MAX40009ANT+ open-drain output comparator, while the MAX40008EVKIT# comes with an open-drain output (MAX40008ANT+). The EV kit requires a 1.7V to 5.5V supply voltage for normal operation. The EV kit can be used to evaluate both the MAX40008 and MAX40009 offered in a WLP package.

Positive Hysteresis

The EV kit allows user to add external hysteresis in addition to the 4mV internal hysteresis by usage of adding appropriate resistors on R2 and R1 pads. When R1 and R2 values are chosen in such a way that $R1, R2 \gg R3$ (39kΩ) approximately greater 50x than R3, then the equations become:

For the MAX40008 (open-drain) output:

$$V_{THP+} = V_{IN} \frac{R2+R3}{R1+R2+R3} + V_{PULL} \frac{R1+R3}{R1+R2+R3}$$

and

$$V_{THN+} = V_{IN} \frac{R2}{R1+R2} + V_{OL} \frac{R1}{R1+R2}$$

when $R1$ and $R2 \gg R3$

$$V_{THP+} = V_{IN} \frac{R2}{R1+R2} + V_P \frac{R1}{R1+R2}$$

$$V_{HYS} = V_{THP} - V_{THN} =$$

$$V_{PULL} \frac{R1+R3}{R1+R2+R3} + V_{OL} \frac{R1}{R1+R2}$$

the term

$$V_{OL} \frac{R1}{R1+R2} \sim 0, \text{ so}$$

$$V_{HYS} = V_{PULL} \frac{R1+R3}{R1+R2+R3}$$

and R5 and R6 set the threshold voltage at IN- input as follows:

$$V_{IN-+} = V_{DD} \frac{R5}{R5+R6}$$

The source providing the signal input at IN+ input should be a low impedance source. High-impedance source affects the trip points as the input resistance of the source adds on to R1.

Logic Level Translation

Use the MAX40008 output for logic-level translation applications. Install jumper J1 and apply the desired supply voltage level at V_{PULL} . Resistors R5 and R6 set the threshold voltage at IN-. Apply the signal to be level translated at IN+. Note that the device's output has an absolute maximum of (-0.3V) to +6V. See [Table 1](#) for jumper configurations.

The pullup supply voltage (V_{PULL}) can be up to 6V.

For evaluating the MAX40008 on the MAX40009EVKIT#, replace U1 (MAX40009ANT+) with MAX40008ANT+ and install jumper J1 to connect to V_{PULL} . When using the MAX40008EVKIT#, to evaluate MAX40009 (push-pull version), replace U1 (MAX40008) with MAX40009 with jumper J1 removed.

Table 1. Jumper Settings

| JUMPER | SHUNT POSITION | FUNCTION |
|--------|----------------|---|
| J1 | Installed | Connects Open-Drain output (MAX40008) to V_{PULL} |
| | Not Installed* | Normal push-pull operation (MAX40009) |
| J2 | 1-2* | The device is in Active mode |
| | 2-3 | The device is shut down |

*Default Jumper settings

Ordering Information

| PART | TYPE |
|----------------|--------|
| MAX40008EVKIT# | EV Kit |
| MAX40009EVKIT# | EV Kit |

#RoHS-compliant

MAX40008 EV Kit Bill of Materials

| ITEM | REF_DES | DNI/DNP | QTY | MFG PART # | MANUFACTURER | VALUE | DESCRIPTION | COMMENTS |
|-------|----------------|---------|-----|----------------|---------------------|----------------|--|----------|
| 1 | C1, C2 | - | 2 | CL05B104K05N1N | SAMSUNG ELECTRONICS | 0.1UF | CAPACITOR; SMT (0402); CERAMIC; 0.1UF; .16V; TOL=10%; TG=55 DEGC TO +125 DEGC; TC=X7R | |
| 2 | X1, X2, GND | - | 3 | 5001 | KEYSTONE | N/A | TEST POINT; PIN DIA=0.1IN; TOTAL LENGTH=0.3IN; BOARD HOLE=0.04IN; BLACK; PHOSPHOR BRONZE WIRE SILVER PLATE FINISH; | |
| 3 | INM, INP, VOUT | - | 3 | 5002 | KEYSTONE | N/A | TEST POINT; PIN DIA=0.1IN; TOTAL LENGTH=0.3IN; BOARD HOLE=0.04IN; WHITE; PHOSPHOR BRONZE WIRE SILVER; | |
| 4 | J1 | - | 1 | FTS-102-01-L-S | SAMTEC | FTS-102-01-L-S | CONNECTOR; MALE; THROUGH HOLE; 1.27MM MICRO LOW PROFILE TERMINAL STRIP; STRAIGHT; 2PINS; | |
| 5 | J2 | - | 1 | FTS-103-01-L-S | SAMTEC | FTS-103-01-L-S | CONNECTOR; MALE; THROUGH HOLE; MICRO LOW PROFILE TERMINAL STRIP; STRAIGHT; 3PINS | |
| 6 | R1 | - | 1 | ERJ-2GEOR00X | PANASONIC | 0 | RESISTOR; 0402; 0 OHM; 0%; JUMPER; 0.10W; THICK FILM | |
| 7 | R3 | - | 1 | ERJ-2RKF3902X | PANASONIC | 39K | RESISTOR; 0402; 39K OHM; 1%; 100PPM; 0.0625W; THICK FILM | |
| 8 | SU1, SU2 | - | 2 | 25N-BK-G | SAMTEC | 25N-BK-G | TEST POINT; JUMPER; STR; TOTAL LENGTH=0.175IN; BLACK; INSULATION=PBT; PHOSPHOR BRONZE CONTACT=GOLD PLATED | |
| 9 | U1 | - | 1 | MAX40008EWT+ | MAXIM | MAX40008EWT+ | EVKIT PART-IC; MAX40008EWT+; PACKAGE OUTLINE: 21-100086C; PACKAGE CODE: N60D1+1; WLP6 | |
| 10 | VDD, VPULL | - | 2 | 5000 | KEYSTONE | N/A | TEST POINT; PIN DIA=0.1IN; TOTAL LENGTH=0.3IN; BOARD HOLE=0.04IN; RED; PHOSPHOR BRONZE WIRE SILVER PLATE FINISH; | |
| 11 | R2, R5, R6 | DNP | 0 | ERJ-2GEOR00X | PANASONIC | 0 | RESISTOR; 0402; 0 OHM; 0%; JUMPER; 0.10W; THICK FILM | |
| 12 | PCB | - | 1 | MAX40008 | MAXIM | PCB | PCB Board:MAX40008 EVALUATION KIT | |
| TOTAL | | | 18 | | | | | |

MAX40008 EV Kit Schematic

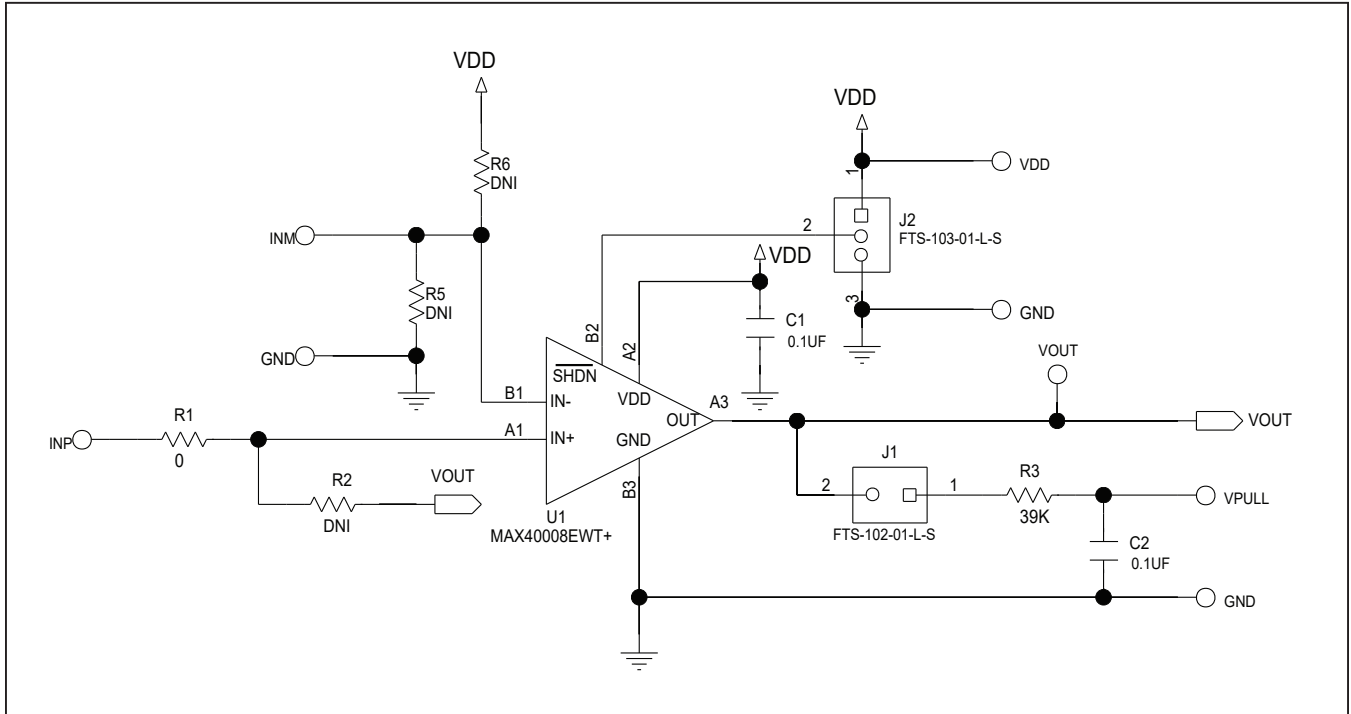

MAX40008 EV Kit PCB Layout Diagrams

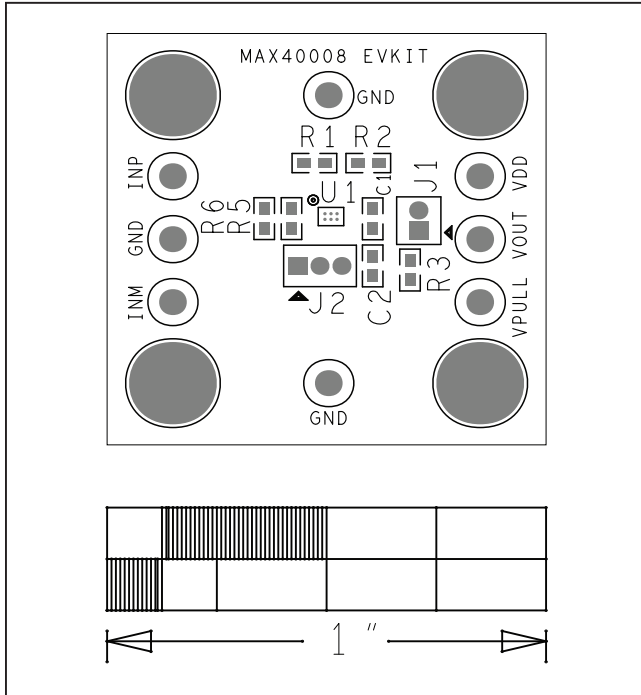

MAX40008 EV Kit—Top Silkscreen

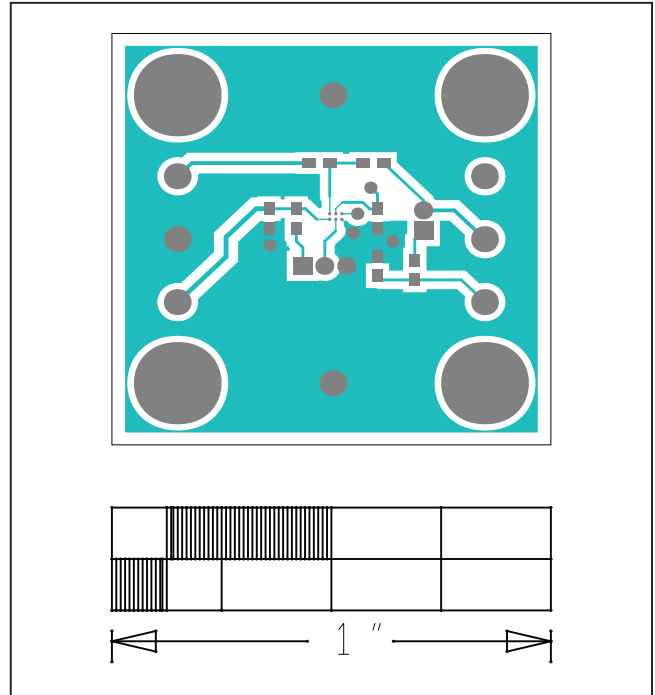

MAX40008 EV Kit—Top

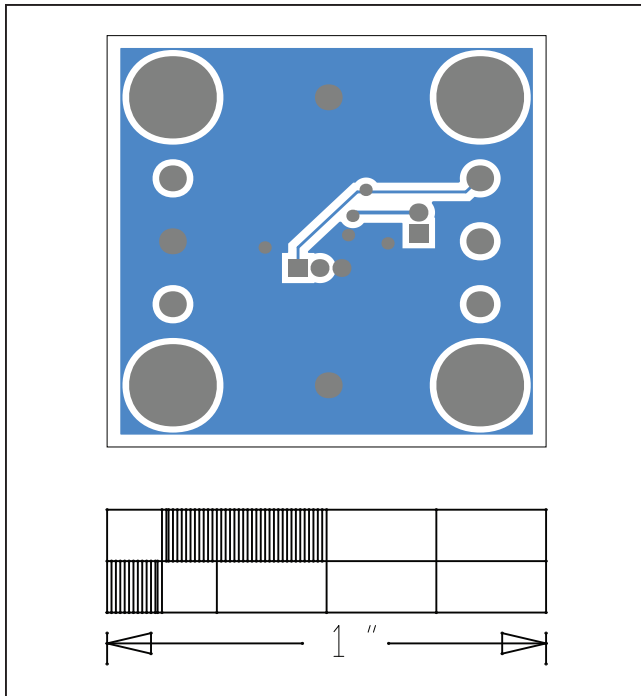

MAX40008 EV Kit—Bottom

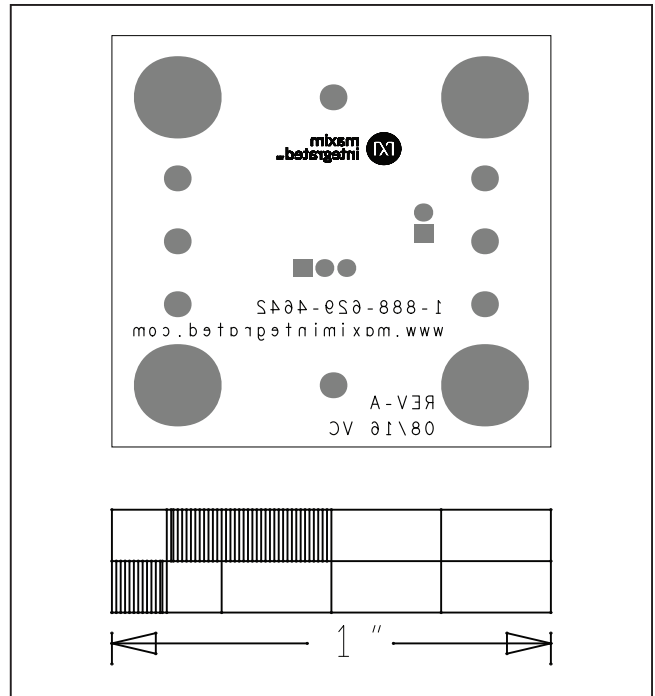

MAX40008 EV Kit—Bottom Silkscreen

MAX40008/MAX40009 Evaluation Kit

Evaluates: MAX40008/MAX40009

MAX40009 EV Kit Bill of Materials

| ITEM | QTY | REF DES | VAR STATUS | MAXIMV | MFG PART # | MANUFACTURER | VALUE | DESCRIPTION | COMMENTS |
|--|-----|----------------|---------------|--------------------|--|---------------------|---|---|----------|
| 1 | 2 | C1, C2 | Pref | 20-000H1B19B | CL05B104K030ANN | SAMSUNG ELECTRONICS | 0.1UF | CAPACITOR, SMT (0402), CERAMIC, 0.1µF, 18V, TOL = 10%; TG = -55°C TO +125°C; TC = X7R | |
| 2 | 3 | X1, X2, GND | Pref | 02-TPMINI5001-00 | 5001 | KEYSTONE | N/A | TEST POINT; PIN DIA = 0.1IN; TOTAL LENGTH = 0.3IN; BOARD HOLE = 0.04IN; BLACK; PHOSPHOR BRONZE WIRE SILVER PLATE FINISH; RECOMMENDED FOR BOARD THICKNESS = 0.082IN; NOT FOR COLD TEST | |
| 3 | 3 | INM, INF, VOUT | Pref | 02-TPMINI5002-00 | 5002 | KEYSTONE | N/A | TEST POINT; PIN DIA = 0.1IN; TOTAL LENGTH = 0.3IN; BOARD HOLE = 0.04IN; WHITE; PHOSPHOR BRONZE WIRE SILVER; NOT FOR COLD TEST | |
| 4 | 1 | J1 | Pref | 01-FTS10201LS2P-19 | FTS-102-01-L-S | SAMTEC | FTS-102-01-L-S | CONNECTOR, MALE; THROUGH HOLE; 1.27MM MICRO LOW PROFILE TERMINAL STRIP; STRAIGHT; 2PINS; NOTE: SPECIAL ORDER ONLY. PURCHASING OF THIS PRODUCT IS CASE-TO-CASE BASIS. | |
| 5 | 1 | J2 | Pref | 01-FTS10301LS3P-21 | FTS-103-01-L-S | SAMTEC | FTS-103-01-L-S | CONNECTOR, MALE; THROUGH HOLE; MICRO LOW PROFILE TERMINAL STRIP; STRAIGHT; 3PINS | |
| 6 | 1 | R1 | Pref | 80-000R-26A | ERJ2GER00X | PANASONIC | 0 | RESISTOR, 0402, 00, 0%, JUMPER, 0.10W, THICK FILM | |
| 7 | 1 | R3 | Pref | 80-003BK-23 | ERJ2BKF302X | PANASONIC | 39K | RESISTOR, 0402, 39KΩ, 1%, 100PPM, 0.0625W, THICK FILM | |
| 8 | 2 | SU1, SU2 | Pref | 02-IMPJF2SNBK-G-00 | 2SN-BK-G | SAMTEC | 2SN-BK-G | TEST POINT, JUMPER STR; TOTAL LENGTH = 0.175IN; BLACK; INSULATION = PBT; PHOSPHOR BRONZE CONTACT-GOLD PLATED | |
| 9 | 1 | U1 | Pref | MAX40009ANT+ | MAX40009ANT+ | MAXIM | MAX40009ANT+ | EVAL KIT PART; IC; MAX40009ANT+; PACKAGE OUTLINE: 21-100866C; | |
| 10 | 2 | VDD, VPULL | Pref | 02-TPMINI5000-00 | 5000 | KEYSTONE | N/A | TEST POINT; PIN DIA = 0.1IN; TOTAL LENGTH = 0.3IN; BOARD HOLE = 0.04IN; RED; PHOSPHOR BRONZE WIRE SILVER PLATE FINISH; RECOMMENDED FOR BOARD THICKNESS = 0.082IN; NOT FOR COLD TEST | |
| 11 | 1 | | Pref | EPCB40009 | MAX40009 | MAXIM | PCB | PCB: MAX40009 | |
| TOTAL | 18 | | | | | | | | |
| DO NOT PURCHASE (DNP) | | | | | | | | | |
| ITEM | QTY | REF DES | VAR STATUS | MAXIMV | MFG PART # <td>MANUFACTURER</td> <td>VALUE</td> <td>DESCRIPTION</td> <td>COMMENTS</td> | MANUFACTURER | VALUE | DESCRIPTION | COMMENTS |
| 1 | 3 | R2, RE, RB | DNP | 80-000R-26A | ERJ2GER00X | PANASONIC | 0 | RESISTOR, 0402, 00, 0%, JUMPER, 0.10W, THICK FILM | |
| TOTAL | 3 | | | | | | | | |
| PACKOUT (These are purchased parts but not assembled on PCB and will be shipped with PCB) | | | | | | | | | |
| ITEM | QTY | REF DES | MAXIMV | MFG PART # | MANUFACTURER | VALUE | DESCRIPTION | COMMENTS | |
| 1 | 1 | PACKOUT | 88-00711-SML | 88-00711-SML | N/A | ? | BOX: SMALL BROWN 9 3/16X7X1 1/4 - PACKOUT | | |
| 2 | 1 | PACKOUT | 87-02162-00 | 87-02162-00 | N/A | ? | ESD BAG; BAG; STATIC SHIELD ZIP 4INX8IN; WISED LOGO - PACKOUT | | |
| 3 | 1 | PACKOUT | 85-MAXKIT-PNK | 85-MAXKIT-PNK | N/A | ? | PINK FOAM; FOAM; ANTI-STATIC PE 12IN X 12IN X 5MM - PACKOUT | | |
| 4 | 1 | PACKOUT | EVSINERT | EVSINERT | N/A | ? | WEB INSTRUCTIONS FOR MAXIM DATA SHEET | | |
| 5 | 1 | PACKOUT | 85-84003-006 | 85-84003-006 | N/A | ? | LABEL/LEV KIT BOX1 - PACKOUT | | |
| TOTAL | 5 | | | | | | | | |

MAX40009 EV Kit Schematics

MECHANICAL

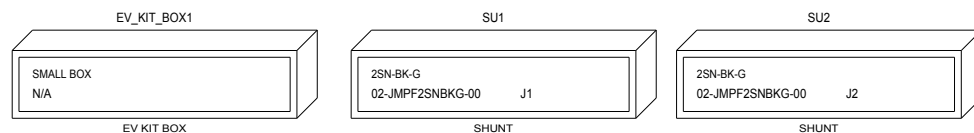

MAX40009 EV Kit Schematics (continued)

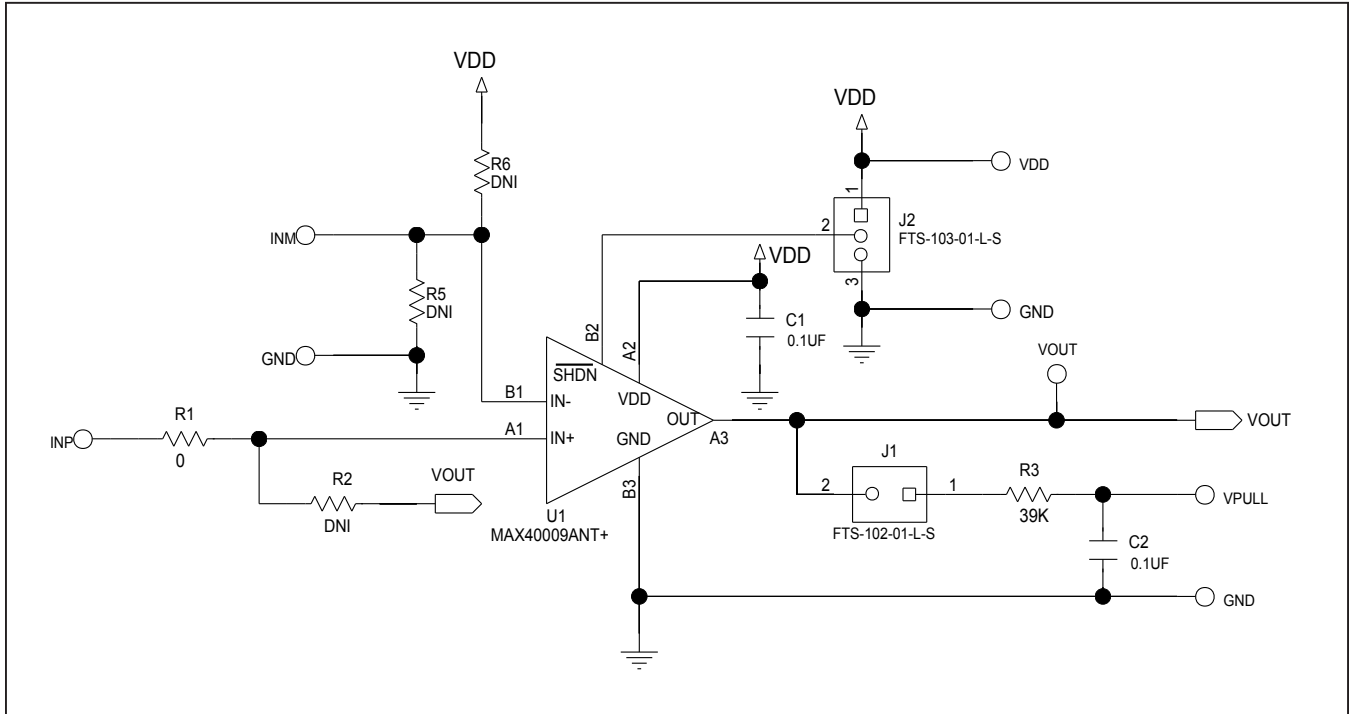

MAX40009 EV Kit PCB Layout Diagrams

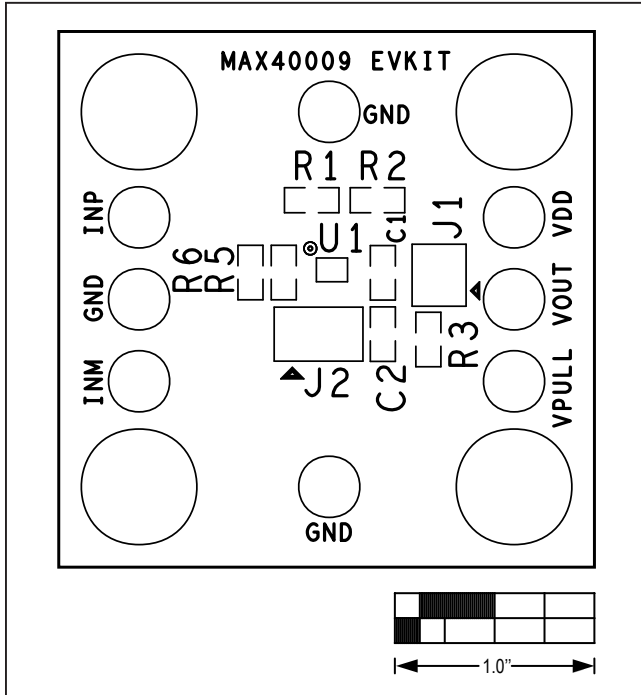

MAX40009 EV Kit—Top Silkscreen

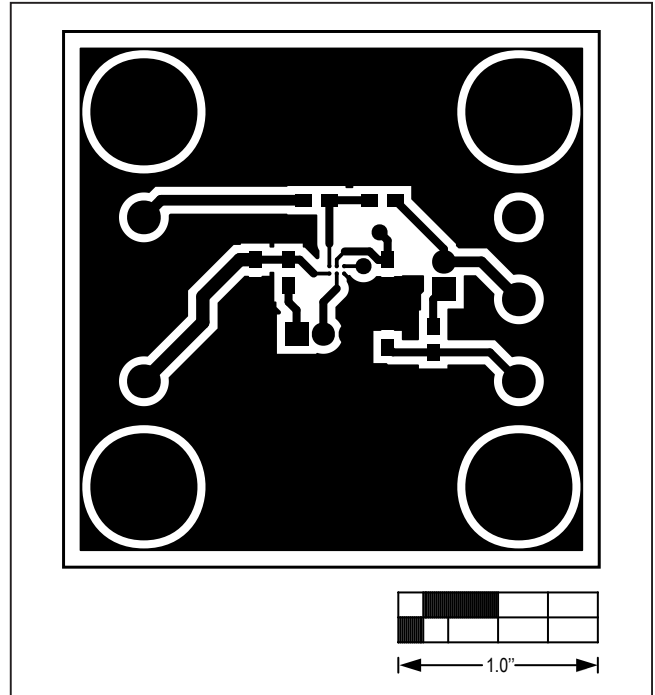

MAX40009 EV Kit—Top

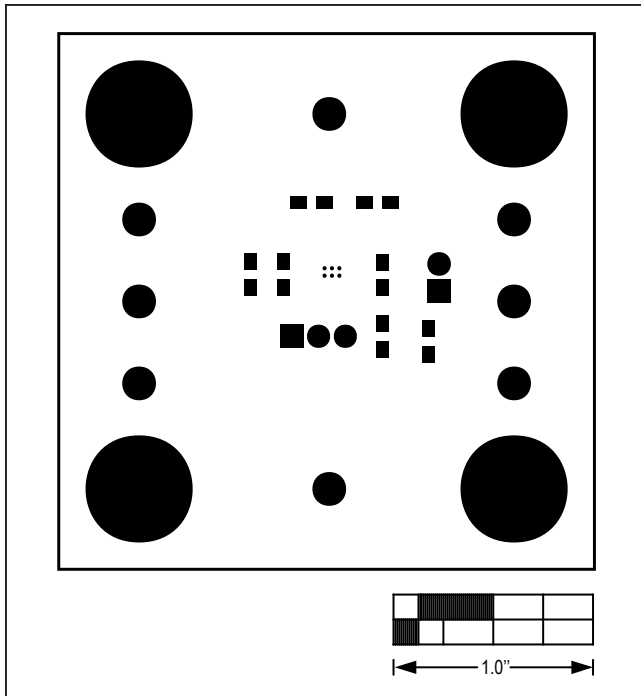

MAX40009 EV Kit—Top Mask

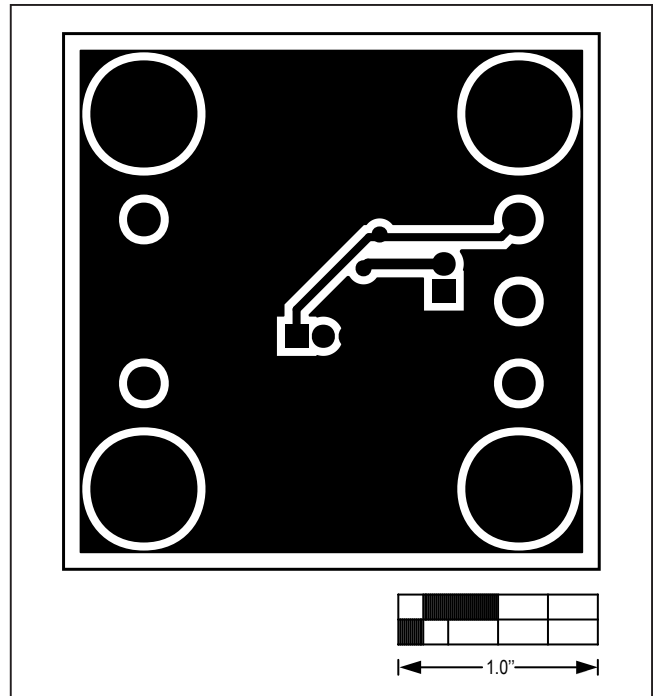

MAX40009 EV Kit—Bottom

MAX40009 EV Kit PCB Layout Diagrams (continued)

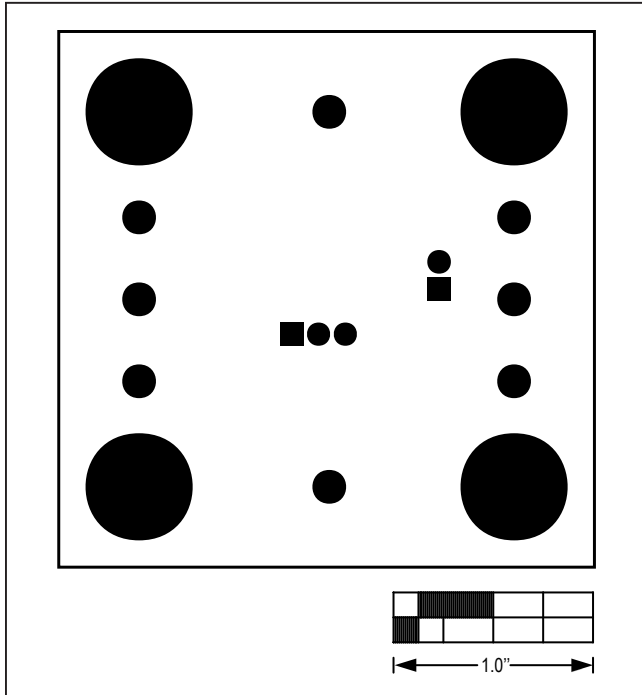

MAX40009 EV Kit—Bottom Mask

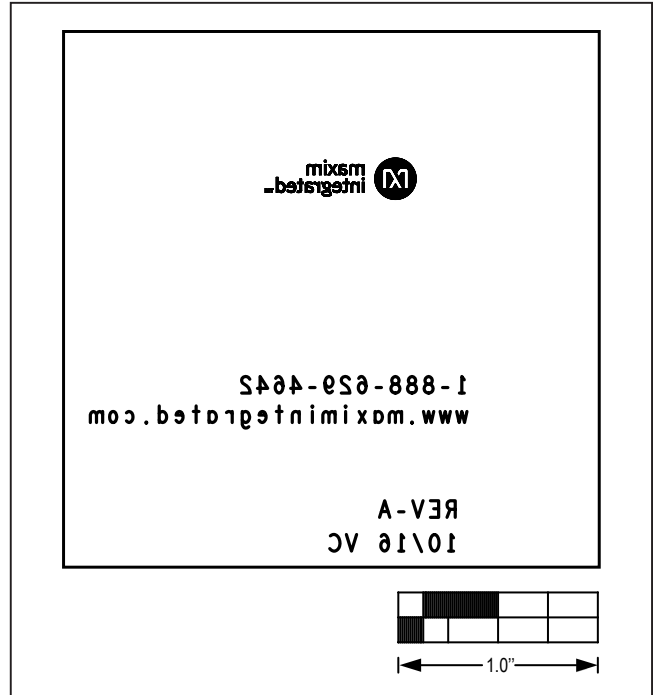

MAX40009 EV Kit—Bottom Silkscreen

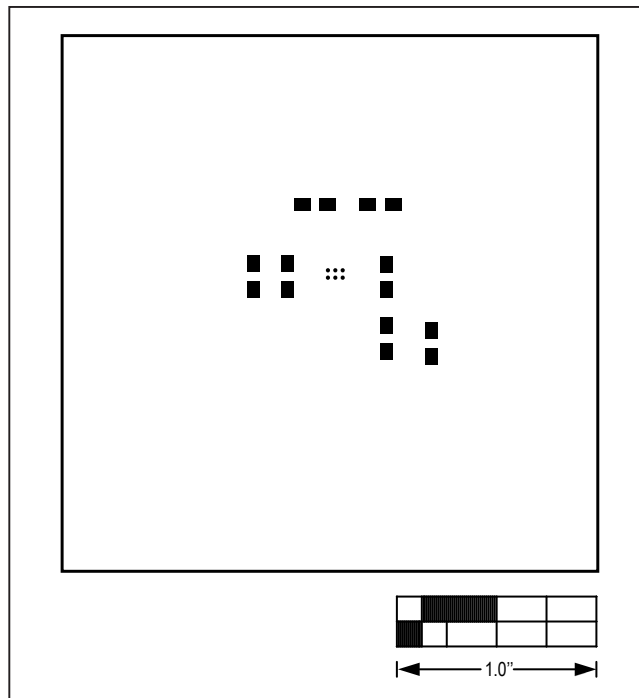

MAX40009 EV Kit—Top Paste

Revision History

| REVISION NUMBER | REVISION DATE | DESCRIPTION | PAGES CHANGED |
|-----------------|---------------|----------------------------|---------------|
| 0 | 3/17 | Initial release | — |
| 1 | 6/17 | Added MAX40008 part number | 1–11 |

For pricing, delivery, and ordering information, please contact Maxim Direct at 1-888-629-4642, or visit Maxim Integrated's website at www.maximintegrated.com.

Maxim Integrated cannot assume responsibility for use of any circuitry other than circuitry entirely embodied in a Maxim Integrated product. No circuit patent licenses are implied. Maxim Integrated reserves the right to change the circuitry and specifications without notice at any time.

Компания «Океан Электроники» предлагает заключение долгосрочных отношений при поставках импортных электронных компонентов на взаимовыгодных условиях!

Наши преимущества:

- Поставка оригинальных импортных электронных компонентов напрямую с производств Америки, Европы и Азии, а так же с крупнейших складов мира;
- Широкая линейка поставок активных и пассивных импортных электронных компонентов (более 30 млн. наименований);
- Поставка сложных, дефицитных, либо снятых с производства позиций;
- Оперативные сроки поставки под заказ (от 5 рабочих дней);
- Экспресс доставка в любую точку России;
- Помощь Конструкторского Отдела и консультации квалифицированных инженеров;
- Техническая поддержка проекта, помощь в подборе аналогов, поставка прототипов;
- Поставка электронных компонентов под контролем ВП;
- Система менеджмента качества сертифицирована по Международному стандарту ISO 9001;
- При необходимости вся продукция военного и аэрокосмического назначения проходит испытания и сертификацию в лаборатории (по согласованию с заказчиком);
- Поставка специализированных компонентов военного и аэрокосмического уровня качества (Xilinx, Altera, Analog Devices, Intersil, Interpoint, Microsemi, Actel, Aeroflex, Peregrine, VPT, Syfer, Eurofarad, Texas Instruments, MS Kennedy, Miteq, Cobham, E2V, MA-COM, Hittite, Mini-Circuits, General Dynamics и др.);

Компания «Океан Электроники» является официальным дистрибьютором и эксклюзивным представителем в России одного из крупнейших производителей разъемов военного и аэрокосмического назначения «JONHON», а так же официальным дистрибьютором и эксклюзивным представителем в России производителя высокотехнологичных и надежных решений для передачи СВЧ сигналов «FORSTAR».



JONHON

«JONHON» (основан в 1970 г.)

Разъемы специального, военного и аэрокосмического назначения:

(Применяются в военной, авиационной, аэрокосмической, морской, железнодорожной, горно- и нефтедобывающей отраслях промышленности)

«FORSTAR» (основан в 1998 г.)

ВЧ соединители, коаксиальные кабели, кабельные сборки и микроволновые компоненты:

(Применяются в телекоммуникациях гражданского и специального назначения, в средствах связи, РЛС, а так же военной, авиационной и аэрокосмической отраслях промышленности).



Телефон: 8 (812) 309-75-97 (многоканальный)

Факс: 8 (812) 320-03-32

Электронная почта: ocean@oceanchips.ru

Web: <http://oceanchips.ru/>

Адрес: 198099, г. Санкт-Петербург, ул. Калинина, д. 2, корп. 4, лит. А