

Optocoupler, Phototransistor Output, With Base Connection

Features

- Isolation Test Voltage 5300 V_{RMS}
- Interfaces with Common Logic Families
- Input-output Coupling Capacitance < 0.5 pF
- Industry Standard Dual-in-line 6-pin Package
- Lead-free component
- Component in accordance to RoHS 2002/95/EC and WEEE 2002/96/EC



1179004



Agency Approvals

- UL1577, File No. E52744 System Code H or J, Double Protection
- DIN EN 60747-5-2 (VDE0884)
DIN EN 60747-5-5 pending
Available with Option 1

Applications

AC Mains Detection
Reed relay driving
Switch Mode Power Supply Feedback
Telephone Ring Detection
Logic Ground Isolation
Logic Coupling with High Frequency Noise Rejection

Description

The 4N25 family is an Industry Standard Single Channel Phototransistor Coupler. This family includes the 4N25/ 4N26/ 4N27/ 4N28. Each optocoupler consists of gallium arsenide infrared LED and a silicon NPN phototransistor.

These couplers are Underwriters Laboratories (UL) listed to comply with a 5300 V_{RMS} isolation test voltage. This isolation performance is accomplished through special Vishay manufacturing process.

Compliance to DIN EN 60747-5-2(VDE0884)/ DIN EN 60747-5-5 pending partial discharge isolation specification is available by ordering option 1.

These isolation processes and the Vishay ISO9001 quality program results in the highest isolation performance available for a commercial plastic phototransistor optocoupler.

The devices are also available in lead formed configuration suitable for surface mounting and are available either on tape and reel, or in standard tube shipping containers.

Note:

For additional design information see Application Note 45 Normalized Curves

Order Information

Part	Remarks
4N25	CTR > 20 %, DIP-6
4N26	CTR > 20 %, DIP-6
4N27	CTR > 10 %, DIP-6
4N28	CTR > 10 %, DIP-6
4N25-X006	CTR > 20 %, DIP-6 400 mil (option 6)
4N25-X007	CTR > 20 %, SMD-6 (option 7)
4N25-X009	CTR > 20 %, SMD-6 (option 9)
4N26-X006	CTR > 20 %, DIP-6 400 mil (option 6)
4N26-X007	CTR > 20 %, SMD-6 (option 7)
4N26-X009	CTR > 20 %, SMD-6 (option 9)
4N27-X007	CTR > 10 %, SMD-6 (option 7)
4N27-X009	CTR > 10 %, SMD-6 (option 9)
4N28-X009	CTR > 10 %, SMD-6 (option 9)

For additional information on the available options refer to Option Information.

Absolute Maximum Ratings

$T_{amb} = 25\text{ °C}$, unless otherwise specified

Stresses in excess of the absolute Maximum Ratings can cause permanent damage to the device. Functional operation of the device is not implied at these or any other conditions in excess of those given in the operational sections of this document. Exposure to absolute Maximum Rating for extended periods of the time can adversely affect reliability.

Input

Parameter	Test condition	Symbol	Value	Unit
Reverse voltage		V_R	6.0	V
Forward current		I_F	60	mA
Surge current	$t < 10\ \mu\text{s}$	I_{FSM}	2.5	A
Power dissipation		P_{diss}	100	mW

Output

Parameter	Test condition	Symbol	Value	Unit
Collector-emitter breakdown voltage		V_{CEO}	70	V
Emitter-base breakdown voltage		V_{EBO}	7.0	V
Collector current		I_C	50	mA
Collector current	$t < 1.0\ \text{ms}$	I_C	100	mA
Power dissipation		P_{diss}	150	mW

Coupler

Parameter	Test condition	Symbol	Value	Unit
Isolation test voltage		V_{ISO}	5300	V_{RMS}
Creepage			≥ 7.0	mm
Clearance			≥ 7.0	mm
Isolation thickness between emitter and detector			≥ 0.4	mm
Comparative tracking index	DIN IEC 112/VDE0303, part 1		175	
Isolation resistance	$V_{IO} = 500\ \text{V}, T_{amb} = 25\text{ °C}$	R_{IO}	10^{12}	Ω
	$V_{IO} = 500\ \text{V}, T_{amb} = 100\text{ °C}$	R_{IO}	10^{11}	Ω
Storage temperature		T_{stg}	- 55 to + 150	$^{\circ}\text{C}$
Operating temperature		T_{amb}	- 55 to + 100	$^{\circ}\text{C}$
Junction temperature		T_j	100	$^{\circ}\text{C}$
Soldering temperature	max. 10 s, dip soldering: distance to seating plane $\geq 1.5\ \text{mm}$	T_{sld}	260	$^{\circ}\text{C}$



Electrical Characteristics

T_{amb} = 25 °C, unless otherwise specified

Minimum and maximum values are testing requirements. Typical values are characteristics of the device and are the result of engineering evaluation. Typical values are for information only and are not part of the testing requirements.

Input

Parameter	Test condition	Symbol	Min	Typ.	Max	Unit
Forward voltage ¹⁾	I _F = 50 mA	V _F		1.3	1.5	V
Reverse current ¹⁾	V _R = 3.0 V	I _R		0.1	100	μA
Capacitance	V _R = 0 V	C _O		25		pF

¹⁾ Indicates JEDEC registered values

Output

Parameter	Test condition	Part	Symbol	Min	Typ.	Max	Unit
Collector-base breakdown voltage ¹⁾	I _C = 100 μA		BV _{CBO}	70			V
Collector-emitter breakdown voltage ¹⁾	I _C = 1.0 mA		BV _{CEO}	30			V
Emitter-collector breakdown voltage ¹⁾	I _E = 100 μA		BV _{ECO}	7.0			V
I _{CEO} (dark) ¹⁾	V _{CE} = 10 V, (base open)	4N25			5.0	50	nA
		4N26			5.0	50	nA
		4N27			5.0	50	nA
		4N28			10	100	nA
I _{CBO} (dark) ¹⁾	V _{CB} = 10 V, (emitter open)				2.0	20	nA
Collector-emitter capacitance	V _{CE} = 0		C _{CE}		6.0		pF

¹⁾ Indicates JEDEC registered values

Coupler

Parameter	Test condition	Part	Symbol	Min	Typ.	Max	Unit
Isolation voltage ¹⁾	Peak, 60 Hz	4N25	V _{IO}	2500			V
		4N26	V _{IO}	1500			V
		4N27	V _{IO}	1500			V
		4N28	V _{IO}	500			V
Saturation voltage, collector-emitter	I _{CE} = 2.0 mA, I _F = 50 mA		V _{CE(sat)}			0.5	V
Resistance, input output ¹⁾	V _{IO} = 500 V		R _{IO}	100			GΩ
Capacitance (input-output)	f = 1.0 MHz		C _{IO}		0.5		pF

¹⁾ Indicates JEDEC registered values

Current Transfer Ratio

Parameter	Test condition	Part	Symbol	Min	Typ.	Max	Unit
DC Current Transfer Ratio ¹⁾	V _{CE} = 10 V, I _F = 10 mA	4N25	CTR _{DC}	20	50		%
		4N26	CTR _{DC}	20	50		%
		4N27	CTR _{DC}	10	30		%
		4N28	CTR _{DC}	10	30		%

¹⁾ Indicates JEDEC registered value

Switching Characteristics

Parameter	Test condition	Symbol	Min	Typ.	Max	Unit
Rise and fall times	$V_{CE} = 10 \text{ V}$, $I_F = 10 \text{ mA}$, $R_L = 100 \Omega$	t_r , t_f		2.0		μs

Typical Characteristics ($T_{amb} = 25 \text{ }^\circ\text{C}$ unless otherwise specified)

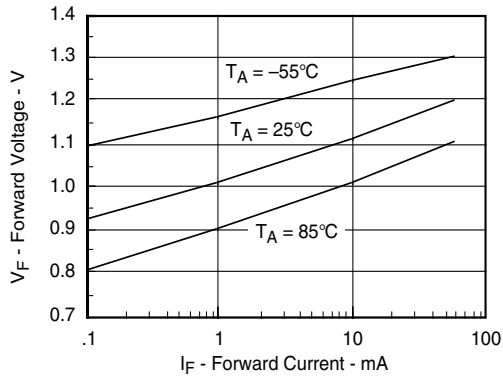

4N25_01

Figure 1. Forward Voltage vs. Forward Current

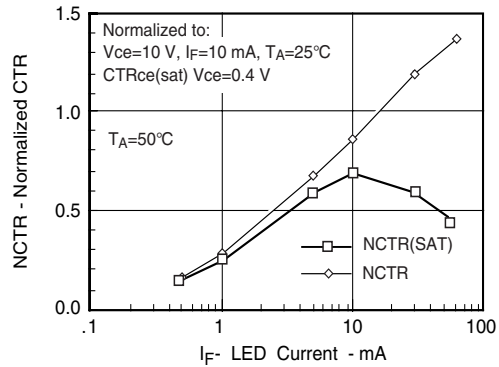

4N25_03

Figure 3. Normalized Non-saturated and Saturated CTR vs. LED Current



4N25_02

Figure 2. Normalized Non-saturated and Saturated CTR vs. LED Current



4N25_04

Figure 4. Normalized Non-saturated and saturated CTR vs. LED Current

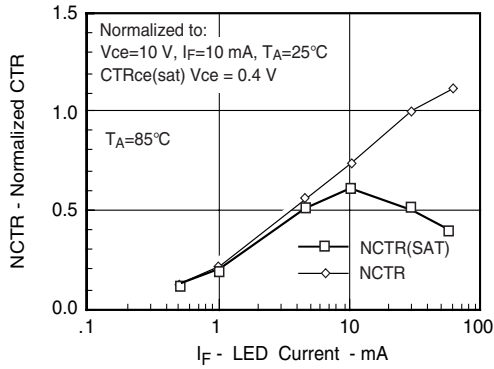

4n25_05

Figure 5. Normalized Non-saturated and saturated CTR vs. LED Current

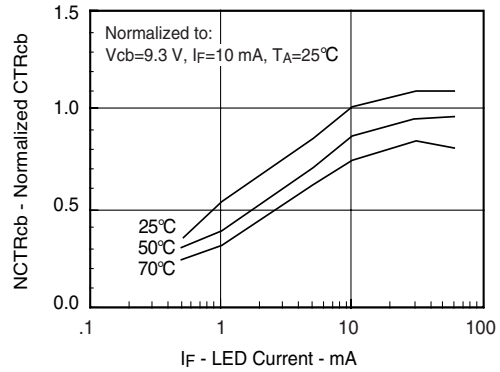

4n25_08

Figure 8. Normalized CTRcb vs. LED Current and Temp.



4n25_06

Figure 6. Collector-Emitter Current vs. Temperature and LED Current



4n25_09

Figure 9. Normalized Photocurrent vs. I_F and Temp.



4n25_07

Figure 7. Collector-Emitter Leakage Current vs. Temp.



4n25_10

Figure 10. Normalized Non-saturated HFE vs. Base Current and Temperature



4n25_11

Figure 11. Normalized HFE vs. Base Current and Temp.



4n25_14

Figure 14. Switching Schematic



4n25_12

Figure 12. Propagation Delay vs. Collector Load Resistor

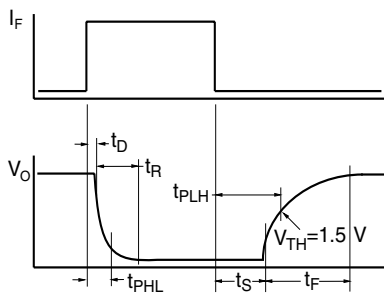

4n25_13

Figure 13. Switching Timing

Package Dimensions in Inches (mm)

For 4N25/26/27..... see DIL300-6 Package dimension in the Package Section.

For 4N28 and for products with an option designator (e.g. 4N25-X001 or 4N26-X007)..... see DIP-6 Package dimensions in the Package Section.

DIL300-6 Package Dimensions



DIP-6 Package Dimensions



4N25/ 4N26/ 4N27/ 4N28

Vishay Semiconductors



Option 6



Option 7



Option 9



18450



Ozone Depleting Substances Policy Statement

It is the policy of Vishay Semiconductor GmbH to

1. Meet all present and future national and international statutory requirements.
2. Regularly and continuously improve the performance of our products, processes, distribution and operating systems with respect to their impact on the health and safety of our employees and the public, as well as their impact on the environment.

It is particular concern to control or eliminate releases of those substances into the atmosphere which are known as ozone depleting substances (ODSs).

The Montreal Protocol (1987) and its London Amendments (1990) intend to severely restrict the use of ODSs and forbid their use within the next ten years. Various national and international initiatives are pressing for an earlier ban on these substances.

Vishay Semiconductor GmbH has been able to use its policy of continuous improvements to eliminate the use of ODSs listed in the following documents.

1. Annex A, B and list of transitional substances of the Montreal Protocol and the London Amendments respectively
2. Class I and II ozone depleting substances in the Clean Air Act Amendments of 1990 by the Environmental Protection Agency (EPA) in the USA
3. Council Decision 88/540/EEC and 91/690/EEC Annex A, B and C (transitional substances) respectively.

Vishay Semiconductor GmbH can certify that our semiconductors are not manufactured with ozone depleting substances and do not contain such substances.

We reserve the right to make changes to improve technical design and may do so without further notice.

Parameters can vary in different applications. All operating parameters must be validated for each customer application by the customer. Should the buyer use Vishay Semiconductors products for any unintended or unauthorized application, the buyer shall indemnify Vishay Semiconductors against all claims, costs, damages, and expenses, arising out of, directly or indirectly, any claim of personal damage, injury or death associated with such unintended or unauthorized use.

Vishay Semiconductor GmbH, P.O.B. 3535, D-74025 Heilbronn, Germany
Telephone: 49 (0)7131 67 2831, Fax number: 49 (0)7131 67 2423

Компания «Океан Электроники» предлагает заключение долгосрочных отношений при поставках импортных электронных компонентов на взаимовыгодных условиях!

Наши преимущества:

- Поставка оригинальных импортных электронных компонентов напрямую с производств Америки, Европы и Азии, а так же с крупнейших складов мира;
- Широкая линейка поставок активных и пассивных импортных электронных компонентов (более 30 млн. наименований);
- Поставка сложных, дефицитных, либо снятых с производства позиций;
- Оперативные сроки поставки под заказ (от 5 рабочих дней);
- Экспресс доставка в любую точку России;
- Помощь Конструкторского Отдела и консультации квалифицированных инженеров;
- Техническая поддержка проекта, помощь в подборе аналогов, поставка прототипов;
- Поставка электронных компонентов под контролем ВП;
- Система менеджмента качества сертифицирована по Международному стандарту ISO 9001;
- При необходимости вся продукция военного и аэрокосмического назначения проходит испытания и сертификацию в лаборатории (по согласованию с заказчиком);
- Поставка специализированных компонентов военного и аэрокосмического уровня качества (Xilinx, Altera, Analog Devices, Intersil, Interpoint, Microsemi, Actel, Aeroflex, Peregrine, VPT, Syfer, Eurofarad, Texas Instruments, MS Kennedy, Miteq, Cobham, E2V, MA-COM, Hittite, Mini-Circuits, General Dynamics и др.);

Компания «Океан Электроники» является официальным дистрибьютором и эксклюзивным представителем в России одного из крупнейших производителей разъемов военного и аэрокосмического назначения «JONHON», а так же официальным дистрибьютором и эксклюзивным представителем в России производителя высокотехнологичных и надежных решений для передачи СВЧ сигналов «FORSTAR».



JONHON

«JONHON» (основан в 1970 г.)

Разъемы специального, военного и аэрокосмического назначения:

(Применяются в военной, авиационной, аэрокосмической, морской, железнодорожной, горно- и нефтедобывающей отраслях промышленности)

«FORSTAR» (основан в 1998 г.)

ВЧ соединители, коаксиальные кабели, кабельные сборки и микроволновые компоненты:

(Применяются в телекоммуникациях гражданского и специального назначения, в средствах связи, РЛС, а так же военной, авиационной и аэрокосмической отраслях промышленности).



Телефон: 8 (812) 309-75-97 (многоканальный)

Факс: 8 (812) 320-03-32

Электронная почта: ocean@oceanchips.ru

Web: <http://oceanchips.ru/>

Адрес: 198099, г. Санкт-Петербург, ул. Калинина, д. 2, корп. 4, лит. А