

 **μC/USB Device™**
Universal Serial Bus Device Stack

User's Manual
V4.00

Micrium

For the Way Engineers Work

Micrium
1290 Weston Road, Suite 306
Weston, FL 33326
USA
www.micrium.com

Designations used by companies to distinguish their products are often claimed as trademarks. In all instances where Micrium Press is aware of a trademark claim, the product name appears in initial capital letters, in all capital letters, or in accordance with the vendor's capitalization preference. Readers should contact the appropriate companies for more complete information on trademarks and trademark registrations. All trademarks and registered trademarks in this book are the property of their respective holders.

Copyright © 2012 by Micrium except where noted otherwise. All rights reserved. Printed in the United States of America. No part of this publication may be reproduced or distributed in any form or by any means, or stored in a database or retrieval system, without the prior written permission of the publisher; with the exception that the program listings may be entered, stored, and executed in a computer system, but they may not be reproduced for publication.

The programs and code examples in this book are presented for instructional value. The programs and examples have been carefully tested, but are not guaranteed to any particular purpose. The publisher does not offer any warranties and does not guarantee the accuracy, adequacy, or completeness of any information herein and is not responsible for any errors or omissions. The publisher assumes no liability for damages resulting from the use of the information in this book or for any infringement of the intellectual property rights of third parties that would result from the use of this information.

Table of Contents

Chapter 1	About USB	15
1-1	Introduction	15
1-1-1	Bus Topology	15
1-1-2	USB Host	16
1-1-3	USB Device	16
1-2	Data Flow Model	17
1-2-1	Endpoint	17
1-2-2	Pipes	18
1-2-3	Transfer Types	18
1-3	Physical Interface and Power Management	21
1-3-1	Speed	21
1-3-2	Power Distribution	22
1-4	Device Structure and Enumeration	22
1-4-1	USB Device Structure	22
1-4-2	Device States	24
1-4-3	Enumeration	25
Chapter 2	Getting Started	27
2-1	Prerequisites	28
2-2	Downloading the Source Code Files	28
2-3	Installing the Files	30
2-4	Building the Sample Application	31
2-4-1	Understanding Micrium Examples	31
2-4-2	Copying and Modifying Template Files	33
2-4-3	Including USB Device Stack Source Code	37
2-4-4	Modifying Application Configuration File	38
2-5	Running the Sample Application	40

Chapter 3	Host Operating Systems	45
3-1	Microsoft Windows	46
3-1-1	About INF Files	46
3-1-2	Using GUIDs	51
Chapter 4	Architecture	53
4-1	Modules Relationship	55
4-1-1	Application	55
4-1-2	Libraries	55
4-1-3	USB Class Layer	56
4-1-4	USB Core Layer	56
4-1-5	Endpoint Management Layer	56
4-1-6	Real-Time Operating System (RTOS) Abstraction Layer	57
4-1-7	Hardware Abstraction Layer	57
4-1-8	CPU Layer	58
4-2	Task Model	58
4-2-1	Sending and Receiving Data	59
4-2-2	Processing USB Requests and Bus Events	61
4-2-3	Processing Debug Events	63
Chapter 5	Configuration	65
5-1	Static Stack Configuration	65
5-1-1	Generic Configuration	66
5-1-2	USB Device Configuration	66
5-1-3	Interface Configuration	66
5-1-4	String Configuration	67
5-1-5	Debug Configuration	68
5-1-6	Communication Device Class (CDC) Configuration	68
5-1-7	CDC Abstract Control Model (ACM) Serial Class Configuration	68
5-1-8	Human Interface Device (HID) Class Configuration	68
5-1-9	Mass Storage Class (MSC) Configuration	69
5-1-10	Personal Healthcare Device Class (PHDC) Configuration	69
5-1-11	Vendor Class Configuration	69
5-2	Application Specific Configuration	69
5-2-1	Task Priorities	69
5-2-2	Task Stack Sizes	70
5-3	Device and Device Controller Driver Configuration	71
5-4	Configuration Examples	71

5-4-1	Simple Full-Speed USB device	72
5-4-2	Composite High-Speed USB device	73
5-4-3	Complex Composite High-Speed USB device	74
Chapter 6	Device Driver Guide	77
6-1	Device Driver Architecture	77
6-2	Device Driver Model	78
6-3	Device Driver API	78
6-4	Interrupt Handling	81
6-4-1	Single USB ISR Vector with ISR Handler Argument	81
6-4-2	Single USB ISR Vector	82
6-4-3	Multiple USB ISR Vectors with ISR Handler Arguments	82
6-4-4	Multiple USB ISR Vectors	83
6-4-5	USB_DrvISR_Handler()	83
6-5	Device Configuration	85
6-5-1	Endpoint Information Table	86
6-6	Memory Allocation	88
6-7	CPU and Board Support	88
6-8	USB Device Driver Functional Model	89
6-8-1	Device Synchronous Receive	89
6-8-2	Device Asynchronous Receive	91
6-8-3	Device Synchronous Transmit	93
6-8-4	Device Asynchronous Transmit	95
6-8-5	Device Set Address	97
Chapter 7	USB Classes	99
7-1	Class Instance Concept	99
7-2	Class Instance Structures	108
7-3	Class and Core Layers Interaction through Callbacks	111
Chapter 8	Communications Device Class	115
8-1	Overview	116
8-2	Architecture	119
8-3	Configuration	120
8-3-1	General Configuration	120
8-4	ACM Subclass	121
8-4-1	Overview	121

8-4-2	General Configuration	123
8-4-3	Subclass Instance Configuration	123
8-4-4	Subclass Notification and Management	127
8-4-5	Subclass Instance Communication	128
8-4-6	Using the Demo Application	129
Chapter 9	Human Interface Device Class	135
9-1	Overview	136
9-1-1	Report	136
9-2	Architecture	142
9-3	Configuration	143
9-3-1	General Configuration	143
9-3-2	Class Instance Configuration	144
9-3-3	Class Instance Communication	150
9-3-4	Synchronous Communication	150
9-3-5	Asynchronous Communication	152
9-4	Using the Demo Application	154
9-4-1	Configuring PC and Device Applications	154
9-4-2	Running the Demo Application	156
9-5	Porting the HID Class to a RTOS	160
9-6	Periodic Input Reports Task	161
Chapter 10	Mass Storage Class	165
10-1	Overview	166
10-1-1	Mass Storage Class Protocol	166
10-1-2	Endpoints	167
10-1-3	Mass Storage Class Requests	167
10-1-4	Small Computer System Interface (SCSI)	168
10-2	Architecture	169
10-2-1	MSC Architecture	169
10-2-2	SCSI Commands	170
10-2-3	Storage Layer and Storage Medium	171
10-3	RTOS Layer	171
10-3-1	Mass Storage Task Handler	171
10-4	Configuration	173
10-4-1	General Configuration	173
10-4-2	Class Instance Configuration	174
10-5	Using the Demo Application	176

10-5-1	USB Device Application	177
10-5-2	USB Host Application	179
10-6	Porting MSC to a Storage Layer	180
10-7	Porting MSC to a RTOS	181
Chapter 11	Personal Healthcare Device Class	183
11-1	Overview	184
11-1-1	Data characteristics	184
11-1-2	Operational model	185
11-2	Configuration	187
11-2-1	General configuration	187
11-2-2	Class instance configuration	189
11-3	Class Instance Communication	192
11-3-1	Communication with metadata preamble	192
11-3-2	Communication without metadata preamble	196
11-4	RTOS QoS-based scheduler	196
11-5	Using the Demo Application	200
11-5-1	Setup the Application	200
11-5-2	Running the Demo Application	202
11-6	Porting PHDC to a RTOS	203
Chapter 12	Vendor Class	205
12-1	Overview	206
12-2	Configuration	207
12-2-1	General Configuration	207
12-2-2	Class Instance Configuration	208
12-2-3	Class Instance Communication	210
12-2-4	Synchronous Communication	211
12-2-5	Asynchronous Communication	212
12-3	USBDev_API	214
12-3-1	Device and Pipe Management	215
12-3-2	Device Communication	218
12-4	Using the Demo Application	220
12-4-1	Configuring PC and Device Applications	220
12-4-2	Editing an INF File	222
12-4-3	Running the Demo Application	224
12-4-4	GUID	228

Chapter 13	Debug and Trace	231
13-1	Using Debug Traces	232
13-1-1	Debug Configuration	232
13-1-2	Debug Trace Output	232
13-1-3	Debug Format	233
13-2	Handling Debug Events	234
13-2-1	Debug Event Pool	234
13-2-2	Debug Task	234
13-2-3	Debug Macros	234
Chapter 14	Porting μ C/USB-Device to your RTOS	237
14-1	Overview	238
14-2	Porting Modules to a RTOS	239
14-3	Core Layer RTOS Model	240
14-3-1	Synchronous Transfer Completion Signals	240
14-3-2	Core Events Management	241
14-3-3	Debug Events Management	241
14-4	Porting The Core Layer to a RTOS	242
Appendix A	Core API Reference	245
A-1	Device Functions	246
A-1-1	USBD_Init()	246
A-1-2	USBD_DevStart()	247
A-1-3	USBD_DevStop()	248
A-1-4	USBD_DevGetState()	249
A-1-5	USBD_DevAdd()	251
A-2	Configuration Functions	253
A-2-1	USBD_CfgAdd()	253
A-3	Interface functions	255
A-3-1	USBD_IF_Add()	255
A-3-2	USBD_IF_AltAdd()	257
A-3-3	USBD_IF_Grp()	259
A-4	Endpoints Functions	261
A-4-1	USBD_CtrlTx()	261
A-4-2	USBD_CtrlRx()	263
A-4-3	USBD_BulkAdd()	265
A-4-4	USBD_BulkRx()	267

A-4-5	USB_D_BulkRxAsync()	269
A-4-6	USB_D_BulkTx()	271
A-4-7	USB_D_BulkTxAsync()	273
A-4-8	USB_D_IntrAdd()	276
A-4-9	USB_D_IntrRx()	278
A-4-10	USB_D_IntrRxAsync()	280
A-4-11	USB_D_IntrTx()	282
A-4-12	USB_D_IntrTxAsync()	284
A-4-13	USB_D_EP_RxZLP()	287
A-4-14	USB_D_EP_TxZLP()	289
A-4-15	USB_D_EP_Abort()	291
A-4-16	USB_D_EP_Stall()	292
A-4-17	USB_D_EP_IsStalled()	294
A-4-18	USB_D_EP_GetMaxPktSize()	295
A-4-19	USB_D_EP_GetMaxPhyNbr()	296
A-4-20	USB_D_EP_GetMaxNbrOpen()	297
A-5	Core OS Functions	298
A-5-1	USB_D_OS_Init()	298
A-5-2	USB_D_CoreTaskHandler()	300
A-5-3	USB_D_DbgTaskHandler()	301
A-5-4	USB_D_OS_EP_SignalCreate()	302
A-5-5	USB_D_OS_EP_SignalDel()	304
A-5-6	USB_D_OS_EP_SignalPend()	305
A-5-7	USB_D_OS_EP_SignalAbort()	307
A-5-8	USB_D_OS_EP_SignalPost()	308
A-5-9	USB_D_OS_CoreEventPut()	309
A-5-10	USB_D_OS_CoreEventGet()	310
A-5-11	USB_D_OS_DbgEventRdy()	311
A-5-12	USB_D_OS_DbgEventWait ()	312
A-6	Device Drivers Callbacks Functions	313
A-6-1	USB_D_EP_RxCmpl()	313
A-6-2	USB_D_EP_TxCmpl()	314
A-6-3	USB_D_EventConn()	315
A-6-4	USB_D_EventDisconn()	316
A-6-5	USB_D_EventReset()	317
A-6-6	USB_D_EventHS()	318
A-6-7	USB_D_EventSuspend()	319

A-6-8	USB_DrvEventResume()	320
A-7	Trace Functions	321
A-7-1	USB_DrvTrace()	321
Appendix B	Device Controller Driver API Reference	323
B-1	Device Driver Functions	324
B-1-1	USB_DrvInit()	324
B-1-2	USB_DrvStart()	326
B-1-3	USB_DrvStop()	328
B-1-4	USB_DrvAddrSet()	329
B-1-5	USB_DrvAddrEn()	330
B-1-6	USB_DrvCfgSet()	331
B-1-7	USB_DrvCfgClr()	332
B-1-8	USB_DrvGetFrameNbr()	333
B-1-9	USB_DrvEP_Open()	334
B-1-10	USB_DrvEP_Close()	336
B-1-11	USB_DrvEP_RxStart()	337
B-1-12	USB_DrvEP_Rx()	339
B-1-13	USB_DrvEP_RxZLP()	341
B-1-14	USB_DrvEP_Tx()	342
B-1-15	USB_DrvEP_TxStart()	344
B-1-16	USB_DrvEP_TxZLP()	346
B-1-17	USB_DrvEP_Abort()	347
B-1-18	USB_DrvEP_Stall()	348
B-1-19	USB_DrvISR_Handler()	349
B-2	Device Driver BSP Functions	350
B-2-1	USB_DrvBSP_Init()	350
B-2-2	USB_DrvBSP_Conn()	351
B-2-3	USB_DrvBSP_Disconn()	352
Appendix C	CDC API Reference	353
C-1	CDC Functions	354
C-1-1	USB_DrvCDC_Init()	354
C-1-2	USB_DrvCDC_Add()	355
C-1-3	USB_DrvCDC_CfgAdd()	358
C-1-4	USB_DrvCDC_IsConn()	360
C-1-5	USB_DrvCDC_DataIF_Add()	361
C-1-6	USB_DrvCDC_DataRx()	363

C-1-7	USBDCDC_DataTx()	365
C-1-8	USBDCDC_Notify()	367
C-2	CDC ACM Subclass Functions	369
C-2-1	USBDCM_SerialInit()	369
C-2-2	USBDCM_SerialAdd()	370
C-2-3	USBDCM_SerialCfgAdd()	371
C-2-4	USBDCM_SerialIsConn()	373
C-2-5	USBDCM_SerialRx()	374
C-2-6	USBDCM_SerialTx()	376
C-2-7	USBDCM_SerialLineCtrlGet()	378
C-2-8	USBDCM_SerialLineCtrlReg()	379
C-2-9	USBDCM_SerialLineCodingGet()	381
C-2-10	USBDCM_SerialLineCodingSet()	382
C-2-11	USBDCM_SerialLineCodingReg()	383
C-2-12	USBDCM_SerialLineStateSet()	385
C-2-13	USBDCM_SerialLineStateClr()	386
Appendix D	HID API Reference	387
D-1	HID Class Functions	388
D-1-1	USBDCM_HID_Init()	388
D-1-2	USBDCM_HID_Add()	389
D-1-3	USBDCM_HID_CfgAdd()	391
D-1-4	USBDCM_HID_IsConn()	393
D-1-5	USBDCM_HID_Rd()	394
D-1-6	USBDCM_HID_RdAsync()	396
D-1-7	USBDCM_HID_Wr()	398
D-1-8	USBDCM_HID_WrAsync()	400
D-2	HID OS Functions	402
D-2-1	USBDCM_HID_OS_Init()	402
D-2-2	USBDCM_HID_OS_InputLock()	403
D-2-3	USBDCM_HID_OS_InputUnlock()	404
D-2-4	USBDCM_HID_OS_InputDataPend()	405
D-2-5	USBDCM_HID_OS_InputDataPendAbort()	407
D-2-6	USBDCM_HID_OS_InputDataPost()	408
D-2-7	USBDCM_HID_OS_OutputLock()	409
D-2-8	USBDCM_HID_OS_OutputUnlock()	410
D-2-9	USBDCM_HID_OS_OutputDataPend()	411
D-2-10	USBDCM_HID_OS_OutputDataPendAbort()	413

D-2-11	USBD_HID_OS_OutputDataPost()	414
D-2-12	USBD_HID_OS_TxLock()	415
D-2-13	USBD_HID_OS_TxUnlock()	416
D-2-14	USBD_HID_OS_TmrTask()	417
Appendix E	MSC API Reference	419
E-1	Mass Storage Class Functions	420
E-1-1	USBD_MSC_Init()	420
E-1-2	USBD_MSC_Add()	421
E-1-3	USBD_MSC_CfgAdd()	422
E-1-4	USBD_MSC_LunAdd()	424
E-1-5	USBD_MSC_IsConn()	426
E-1-6	USBD_MSC_TaskHandler()	427
E-2	MSC OS Functions	428
E-2-1	USBD_MSC_OS_Init()	428
E-2-2	USBD_MSC_OS_CommSignalPost()	429
E-2-3	USBD_MSC_OS_CommSignalPend()	430
E-2-4	USBD_MSC_OS_CommSignalDel()	431
E-2-5	USBD_MSC_OS_EnumSignalPost()	432
E-2-6	USBD_MSC_OS_EnumSignalPend()	433
E-3	MSC Storage Layer Functions	434
E-3-1	USBD_StorageInit()	434
E-3-2	USBD_StorageCapacityGet()	435
E-3-3	USBD_StorageRd()	436
E-3-4	USBD_StorageWr()	437
E-3-5	USBD_StorageStatusGet()	439
Appendix F	PHDC API Reference	441
F-1	PHDC Functions	442
F-1-1	USBD_PHDC_Init()	442
F-1-2	USBD_PHDC_Add()	443
F-1-3	USBD_PHDC_CfgAdd()	445
F-1-4	USBD_PHDC_IsConn()	447
F-1-5	USBD_PHDC_RdCfg()	448
F-1-6	USBD_PHDC_WrCfg()	450
F-1-7	USBD_PHDC_11073_ExtCfg()	452
F-1-8	USBD_PHDC_RdPreamble()	454
F-1-9	USBD_PHDC_Rd()	456

F-1-10	USBD_PHDC_Wrpreamble()	458
F-1-11	USBD_PHDC_Wr()	460
F-1-12	USBD_PHDC_Reset()	462
F-2	PHDC OS Layer Functions	463
F-2-1	USBD_PHDC_OS_Init()	463
F-2-2	USBD_PHDC_OS_RdLock()	464
F-2-3	USBD_PHDC_OS_RdUnLock()	466
F-2-4	USBD_PHDC_OS_WrIntrLock()	467
F-2-5	USBD_PHDC_OS_WrIntrUnLock()	468
F-2-6	USBD_PHDC_OS_WrBulkLock()	469
F-2-7	USBD_PHDC_OS_WrBulkUnLock()	471
Appendix G	Vendor Class API Reference	473
G-1	Vendor Class Functions	474
G-1-1	USBD_Vendor_Init()	474
G-1-2	USBD_Vendor_Add()	475
G-1-3	USBD_Vendor_CfgAdd()	477
G-1-4	USBD_Vendor_IsConn()	479
G-1-5	USBD_Vendor_Rd()	481
G-1-6	USBD_Vendor_Wr()	483
G-1-7	USBD_Vendor_RdAsync()	485
G-1-8	USBD_Vendor_WrAsync()	487
G-1-9	USBD_Vendor_IntrRd()	489
G-1-10	USBD_Vendor_IntrWr()	491
G-1-11	USBD_Vendor_IntrRdAsync()	493
G-1-12	USBD_Vendor_IntrWrAsync()	495
G-2	USBDev_API Functions	497
G-2-1	USBDev_GetNbrDev()	497
G-2-2	USBDev_Open()	499
G-2-3	USBDev_Close()	500
G-2-4	USBDev_GetNbrAltSetting()	501
G-2-5	USBDev_GetNbrAssociatedIF()	503
G-2-6	USBDev_SetAltSetting()	504
G-2-7	USBDev_GetCurAltSetting()	506
G-2-8	USBDev_IsHighSpeed()	508
G-2-9	USBDev_BulkIn_Open()	509
G-2-10	USBDev_BulkOut_Open()	510
G-2-11	USBDev_IntrIn_Open()	511

G-2-12	USBDev_IntrOut_Open()	512
G-2-13	USBDev_PipeGetAddr()	513
G-2-14	USBDev_PipeClose()	514
G-2-15	USBDev_PipeStall()	515
G-2-16	USBDev_PipeAbort()	516
G-2-17	USBDev_CtrlReq()	517
G-2-18	USBDev_PipeWr()	520
G-2-19	USBDev_PipeRd()	522
G-2-20	USBDev_PipeRdAsync()	524
Appendix H	Error Codes	527
H-1	Generic Error Codes	528
H-2	Device Error Codes	528
H-3	Configuration Error Codes	528
H-4	Interface Error Codes	529
H-5	Endpoint Error Codes	529
H-6	OS Layer Error Codes	529
Appendix I	Memory Footprint	531
I-0-1	Communications Device Class	532
I-0-2	Human Interface Device Class	533
I-0-3	Mass Storage Class	534
I-0-4	Personal Healthcare Device Class	535
I-0-5	Vendor Class	537

Chapter

1

About USB

This chapter presents a quick introduction to USB. The first section in this chapter introduces the basic concepts of the USB specification Revision 2.0. The second section explores the data flow model. The third section gives details about the device operation. Lastly, the fourth section describes USB device logical organization.

The full protocol is described extensively in the USB Specification Revision 2.0 at <http://www.usb.org>.

1-1 INTRODUCTION

The Universal Serial Bus (USB) is an industry standard maintained by the USB Implementers Forum (USB-IF) for serial bus communication. The USB specification contains all the information about the protocol such as the electrical signaling, the physical dimension of the connector, the protocol layer, and other important aspects. USB provides several benefits compared to other communication interfaces such as ease of use, low cost, low power consumption and, fast and reliable data transfer.

1-1-1 BUS TOPOLOGY

USB can connect a series of devices using a tiered star topology. The key elements in USB topology are the *host*, *hubs*, and *devices*, as illustrated in Figure 1-1. Each node in the illustration represents a USB hub or a USB device. At the top level of the graph is the root hub, which is part of the host. There is only one host in the system. The specification allows up to seven tiers and a maximum of five non-root hubs in any path between the host and a device. Each tier must contain at least one hub except for the last tier where only devices are present. Each USB device in the system has a unique address assigned by the host through a process called *enumeration* (see section 1-4-3 on page 25 for more details on enumeration).

The host learns about the device capabilities during enumeration, which allows the host operating system to load a specific driver for a particular USB device. The maximum number of peripherals that can be attached to a host is 127, including the root hub.



Figure 1-1 **Bus topology**

1-1-2 USB HOST

The USB host communicates with the devices using a USB host controller. The host is responsible for detecting and enumerating devices, managing bus access, performing error checking, providing and managing power, and exchanging data with the devices.

1-1-3 USB DEVICE

A USB device implements one or more USB *functions* where a function provides one specific capability to the system. Examples of USB functions are keyboards, webcam, speakers, or a mouse. The requirements of the USB functions are described in the USB class specification. For example, keyboards and mice are implemented using the Human Interface Device (HID) specification.

USB devices must also respond to requests from the host. For example, on power up, or when a device is connected to the host, the host queries the device capabilities during enumeration, using standard requests.

1-2 DATA FLOW MODEL

This section defines the elements involved in the transmission of data across USB.

1-2-1 ENDPOINT

Endpoints function as the point of origin or the point of reception for data. An endpoint is a logical entity identified using an endpoint address. The endpoint address of a device is fixed, and is assigned when the device is designed, as opposed to the device address, which is assigned by the host dynamically during enumeration. An endpoint address consists of an endpoint number field (0 to 15), and a direction bit that indicates if the endpoint sends data to the host (IN) or receives data from the host (OUT). The maximum number of endpoints allowed on a single device is 32.

Endpoints contain configurable characteristics that define the behavior of a USB device:

- Bus access requirements
- Bandwidth requirement
- Error handling
- Maximum packet size that the endpoint is able to send or receive
- Transfer type
- Direction in which data is sent and receive from the host

ENDPOINT ZERO REQUIREMENT

Endpoint zero (also known as Default Endpoint) is a bi-directional endpoint used by the USB host system to get information, and configure the device via standard requests. All devices must implement an endpoint zero configured for control transfers (see section “Control Transfers” on page 18 for more information).

1-2-2 PIPES

A USB pipe is a logical association between an endpoint and a software structure in the USB host software system. USB pipes are used to send data from the host software to the device's endpoints. A USB pipe is associated to a unique endpoint address, type of transfer, maximum packet size, and interval for transfers.

The USB specification defines two types of pipes based on the communication mode:

- Stream Pipes: Data carried over the pipe is unstructured.
- Message Pipes: Data carried over the pipe has a defined structure.

The USB specification requires a default control pipe for each device. A default control pipe uses endpoint zero. The default control pipe is a bi-directional message pipe.

1-2-3 TRANSFER TYPES

The USB specification defines four transfer types that match the bandwidth and services requirements of the host and the device application using a specific pipe. Each USB transfer encompasses one or more transactions that sends data to and from the endpoint. The notion of transactions is related to the maximum payload size defined by each endpoint type in that when a transfer is greater than this maximum, it will be split into one or more transactions to fulfill the action.

CONTROL TRANSFERS

Control transfers are used to configure and retrieve information about the device capabilities. They are used by the host to send standard requests during and after enumeration. Standard requests allow the host to learn about the device capabilities; for example, how many and which functions the device contains. Control transfers are also used for class-specific and vendor-specific requests.

A control transfer contains three stages: Setup, Data, and Status. These stages are detailed in Table 1-1.

Stage	Description
Setup	The Setup stage includes information about the request. This SETUP stage represents one transaction.
Data	The Data stage contains data associated with request. Some standard and class-specific request may not require a Data stage. This stage is an IN or OUT directional transfer and the complete Data stage represents one or more transactions.
Status	The Status stage, representing one transaction, is used to report the success or failure of the transfer. The direction of the Status stage is opposite to the direction of the Data stage. If the control transfer has no Data stage, the Status stage always is from the device (IN).

Table 1-1 **Control Transfer Stages**

BULK TRANSFERS

Bulk transfers are intended for devices that exchange large amounts of data where the transfer can take all of the available bus bandwidth. Bulk transfers are reliable, as error detection and retransmission mechanisms are implemented in hardware to guarantee data integrity. However, bulk transfers offer no guarantee on timing. Printers and mass storage devices are examples of devices that use bulk transfers.

INTERRUPT TRANSFERS

Interrupt transfers are designed to support devices with latency constraints. Devices using interrupt transfers can schedule data at any time. Devices using interrupt transfer provides a polling interval which determines when the scheduled data is transferred on the bus. Interrupt transfers are typically used for event notifications.

ISOCRONOUS TRANSFERS

Isochronous transfers are used by devices that require data delivery at a constant rate with a certain degree of error-tolerance. Retransmission is not supported by isochronous transfers. Audio and video devices use isochronous transfers.

USB DATA FLOW MODEL

Table 1-2 shows a graphical representation of the data flow model.

Figure 1-2 **USB data flow**

- F1-2(1) The host software uses standard requests to query and configure the device using the default pipe. The default pipe uses endpoint zero (EP0).
- F1-2(2) USB pipes allow associations between the host application and the device's endpoints. Host applications send and receive data through USB pipes.
- F1-2(3) The host controller is responsible for the transmission, reception, packing and unpacking of data over the bus.
- F1-2(4) Data is transmitted via the physical media.
- F1-2(5) The device controller is responsible for the transmission, reception, packing and unpacking of data over the bus. The USB controller informs the USB device software layer about several events such as bus events and transfer events.
- F1-2(6) The device software layer responds to the standard request, and implements one or more USB functions as specified in the USB class document.

TRANSFER COMPLETION

The notion of transfer completion is only relevant for control, bulk and interrupt transfers as isochronous transfers occur continuously and periodically by nature. In general, control, bulk and interrupt endpoints must transmit data payload sizes that are less than or equal to the endpoint's maximum data payload size. When a transfer's data payload is greater than the maximum data payload size, the transfer is split into several transactions whose payload is maximum-sized except the last transaction which contains the remaining data. A transfer is deemed complete when:

- The endpoint transfers exactly the amount of data expected.
- The endpoint transfers a short packet, that is a packet with a payload size less than the maximum.
- The endpoint transfers a zero-length packet.

1-3 PHYSICAL INTERFACE AND POWER MANAGEMENT

USB transfers data and provides power using four-wire cables. The four wires are: V_{bus} , D^+ , D^- and Ground. Signaling occurs on the D^+ and D^- wires.

1-3-1 SPEED

The USB 2.0 specification defines three different speeds.

- Low Speed: 1.5 Mb/s
- Full Speed: 12 Mb/s
- High Speed: 480 Mb/s

1-3-2 POWER DISTRIBUTION

The host can supply power to USB devices that are directly connected to the host. USB devices may also have their own power supplies. USB devices that use power from the cable are called bus-powered devices. Bus-powered device can draw a maximum of 500 mA from the host. USB devices that have alternative source of power are called self-powered devices.

1-4 DEVICE STRUCTURE AND ENUMERATION

Before the host application can communicate with a device, the host needs to understand the capabilities of the device. This process takes place during device enumeration. After enumeration, the host can assign and load a specific driver to allow communication between the application and the device.

During enumeration, the host assigns an address to the device, reads descriptors from the device, and selects a configuration that specifies power and interface requirements. In order for the host learns about the device's capabilities, the device must provide information about itself in the form of descriptors.

This section describes the device logical organization from the USB host's point of view.

1-4-1 USB DEVICE STRUCTURE

From the host point of view, USB devices are internally organized as a collection of configurations, interfaces and endpoints.

CONFIGURATION

A USB configuration specifies the capabilities of a device. A configuration consists of a collection of USB interfaces that implement one or more USB functions. Typically only one configuration is required for a given device. However, the USB specification allows up to 255 different configurations. During enumeration, the host selects a configuration. Only one configuration can be active at a time. The device uses a *configuration descriptor* to inform the host about a specific configuration's capabilities.

INTERFACE

A USB interface or a group of interfaces provides information about a function or class implemented by the device. An interface can contain multiple mutually exclusive settings called *alternate settings*. The device uses an *interface descriptor* to inform the host about a specific interface's capabilities. Each interface descriptor contains a class, subclass, and protocol codes defined by the USB-IF, and the number of endpoints required for a particular class implementation.

ALTERNATE SETTINGS

Alternate settings are used by the device to specify mutually exclusive settings for each interface. The default alternate settings contain the default settings of the device. The device also uses an interface descriptor to inform the host about an interface's alternate settings.

ENDPOINT

An interface requires a set of endpoints to communicate with the host. Each interface has different requirements in terms of the number of endpoints, transfer type, direction, maximum packet size, and maximum polling interval. The device sends an endpoint descriptor to notify the host about endpoint capabilities.

Figure 1-3 shows the hierarchical organization of a USB device. Configurations are grouped based on the device's speed. A high-speed device might have a particular configuration in both high-speed and low/full speed.



Figure 1-3 USB device structure

1-4-2 DEVICE STATES

The USB 2.0 specification defines six different states and are detailed in Table 1-2.

Device States	Description
Attached	The device is in the Attached state when it is connected to the host or a hub port. The hub must be connected to the host or to another hub.
Powered	A device is considered in the Powered state when it starts consuming power from the bus. Only bus-powered devices use power from the host. Self-powered devices are in the Powered state after port attachment.
Default	After the device has been powered, it should not respond to any request or transactions until it receives a reset signal from the host. The device enters in the Default state when it receives a reset signal from the host. In the Default state, the device responds to standard requests at the default address 0.
Address	During enumeration, the host assigns a unique address to the device. When this occurs, the device moves from the Default state to the Address state.

Device States	Description
Configurated	After the host assigns an address to the device, the host must select a configuration. After the host selects a configuration, the device enters the Configured state. In this state, the device is ready to communicate with the host applications.
Suspended	The device enters in Suspended state when no traffic has been seen in the bus for a specific period of time. The device retains the address assigned by the host in the Suspended state. The device returns to the previous state after traffic is present in the bus.

Table 1-2 **USB Device States**

1-4-3 ENUMERATION

Enumeration is the process where the host configures the device and learns about the device's capabilities. The host starts enumeration after the device is attached to one of the root or external hub ports. The host learns about the device's manufacturer, vendor/product IDs and release versions by sending a *Get Descriptor* request to obtain the device descriptor and the maximum packet size of the default pipe (control endpoint 0). Once that is done, the host assigns a unique address to the device which will tell the device to only answer requests at this unique address. Next, the host gets the capabilities of the device by a series of *Get Descriptor* requests. The host iterates through all the available configurations to retrieve information about number of interfaces in each configuration, interfaces classes, and endpoint parameters for each interface and will lastly finish the enumeration process by selecting the most suitable configuration.

Chapter

2

Getting Started

This chapter gives you some insight into how to install and use the μ C/USB-Device stack. The following topics are explained in this chapter:

- Prerequisites
- Downloading the source code files
- Installing the files
- Building the sample application
- Running the sample application

After the completion of this chapter, you should be able to build and run your first USB application using the μ C/USB-Device stack.

2-1 PREREQUISITES

Before running your first application, you must ensure that you have the minimal set of required tools and components:

- Toolchain for your specific microcontroller.
- Development board.
- μ C/USB-Device stack with the source code of at least one of the Micrium USB classes.
- USB device controller driver compatible with your hardware for the μ C/USB-Device stack.
- Board support package (BSP) for your development board.
- Example project for your selected RTOS (that is μ C/OS-II or μ C/OS-III).

If Micrium does not support your USB device controller or BSP, you will have to write your own device driver. Refer to Chapter 6, “Device Driver Guide” on page 77 for more information on writing your own USB device driver.

2-2 DOWNLOADING THE SOURCE CODE FILES

μ C/USB-Device can be downloaded from the Micrium customer portal. The distribution package includes the full source code and documentation. You can log into the Micrium customer portal at the address below to begin your download (you must have a valid license to gain access to the file):

<http://micrium.com/login>

μ C/USB-Device depends on other modules, and you need to install all the required modules before building your application. Depending on the availability of support for your hardware platform, ports and drivers may or may not be available for download from the customer portal. Table 2-1 shows the module dependency for μ C/USB-Device.

Module Name	Required	Note(s)
µC/USB-Device Core	YES	Hardware independent USB stack.
µC/USB-Device Driver	YES	USB device controller driver. Available only if Micrium supports your controller, otherwise you have to develop it yourself.
µC/USB-Device Vendor Class	Optional	Available only if you purchased Vendor class.
µC/USB-Device MSC	Optional	Available only if you purchased Mass Storage Class (MSC).
µC/USB-Device HID Class	Optional	Available only if you purchased Human Interface Device (HID) class.
µC/USB-Device CDC ACM	Optional	Available only if you purchased Communication Device Class (CDC) with the Abstract Control Model (ACM) subclass.
µC/USB-Device PHDC	Optional	Available only if you purchased Personal Healthcare Device Class (PHDC).
µC/CPU Core	YES	
µC/CPU Port	YES	Available only if Micrium has support for your target architecture (ARM, AVR32, MSP430, etc)
µC/LIB Core	YES	Micrium run-time library.
µC/LIB Port	Optional	Available only if Micrium has support for your target architecture (ARM, AVR32, MSP430, etc)
µC/OS-II Core	Optional	Available only if your application is using µC/OS-II
µC/OS-II Port	Optional	Available only if Micrium has support for your target architecture (ARM, AVR32, MSP430, etc)
µC/OS-III Core	Optional	Available only if your application is using µC/OS-III
µC/OS-III Port	Optional	Available only if Micrium has support for your target architecture (ARM, AVR32, MSP430, etc)

Table 2-1 µC/USB-Device Module Dependency

Table 2-1 indicates that all the µC/USB-Device classes are optional because there is no mandatory class to purchase with the µC/USB-Device Core and Driver. The class you will have purchased will depend on your needs. But don't forget that you need a class to build a complete USB project. Table 2-1 also indicates that µC/OS-II and -III Core and Port are optional. Indeed, µC/USB-Device stack does not assume a specific real-time operating system to work with but it still requires one.

2-3 INSTALLING THE FILES

Once all the distribution packages have been downloaded to your host machine, extract all the files at the root of your C:\ drive for instance. The package may be extracted to any location. After extracting all the files, the directory structure should look as shown in Figure 2-1. In the example, all Micrium products sub-folders shown in Figure 2-1 will be located in C:\Micrium\Software\.



Figure 2-1 Directory Tree for μ C/USB-Device

2-4 BUILDING THE SAMPLE APPLICATION

This section describes all the steps required to build a USB-based application. The instructions provided in this section are not intended for any particular toolchain, but instead are described in a generic way that can be adapted to any toolchain.

The best way to start building a USB-based project is to start from an existing project. If you are using $\mu\text{C}/\text{OS-II}$ or $\mu\text{C}/\text{OS-III}$, Micrium provides example projects for multiple development boards and compilers. If your target board is not listed on Micrium's web site, you can download an example project for a similar board or microcontroller.

The purpose of the sample project is to allow a host to enumerate your device. You will add a USB class instance to both, full-speed and high-speed configurations (if both are supported by your controller). Refer to section 7-1 "Class Instance Concept" on page 99 for more details about the class instance concept. After you have successfully completed and run the sample project, you can use it as a starting point to run other USB class demos you may have purchased.

$\mu\text{C}/\text{USB-Device}$ requires a Real-Time Operating System (RTOS). The following assumes that you have a working example project running on $\mu\text{C}/\text{OS-II}$ or $\mu\text{C}/\text{OS-III}$.

2-4-1 UNDERSTANDING MICRIUM EXAMPLES

A Micrium example project is usually placed in the following directory structure.

```
\Micrium
  \Software
    \EvalBoards
      \<manufacturer>
        \<board_name>
          \<compiler>
            \<project name>
              \*.*
```

Note that Micrium does *not* provide by default an example project with the $\mu\text{C}/\text{USB-Device}$ distribution package. Micrium examples are provided to customers in specific situations. If it happens that you receive a Micrium example, the directory structure shown above is generally used by Micrium. You may use a different directory structure to store the application and toolchain projects files.

\Micrium

This is where Micrium places all software components and projects. This directory is generally located at the root directory.

\Software

This sub-directory contains all software components and projects.

\EvalBoards

This sub-directory contains all projects related to evaluation boards supported by Micrium.

\<manufacturer>

This is the name of the manufacturer of the evaluation board. In some cases this can be also the name of the microcontroller manufacturer.

\<board name>

This is the name of the evaluation board.

\<compiler>

This is the name of the compiler or compiler manufacturer used to build the code for the evaluation board.

\<project name>

The name of the project that will be demonstrated. For example a simple μ C/USB-Device with μ C/OS-III project might have the project name 'uCOS-III-USB'D'.

.

These are the source files for the project. This directory contains configuration files **app_cfg.h**, **os_cfg.h**, **os_cfg_app.h**, **cpu_cfg.h** and other project-required sources files.

os_cfg.h is a configuration file used to configure μ C/OS-III (or μ C/OS-II) parameters such as the maximum number of tasks, events, objects, which μ C/OS-III services are enabled (semaphores, mailboxes, queues), and so on. **os_cfg.h** is a required file for any μ C/OS-III application. See the μ C/OS-III documentation and books for further information.

app.c contains the application code for the example project. As with most C programs, code execution starts at **main()**. At a minimum, **app.c** initializes μ C/OS-III and creates a startup task that initializes other Micrium modules.

app_cfg.h is a configuration file for your application. This file contains `#defines` to configure the priorities and stack sizes of your application and the Micrium modules' tasks.

app_<module>.c and **app_<module>.h** These optional files contain the Micrium modules' (μ C/TCP-IP, μ C/FS, μ C/USB-Host, etc) initialization code. They may or may not be present in the example projects.

2-4-2 COPYING AND MODIFYING TEMPLATE FILES

Copy the files from the application template and configuration folders into your application as shown in Figure 2-2.



Figure 2-2 Copying Template Files.

app_usbd.* is the master template for USB application-specific initialization code. This file contains the function **App_USB_Init()**, which initializes the USB stack and class-specific demos.

app_usbd_<class>.c contains a template to initialize and use a certain class. This file contains the class demo application. In general, the class application initializes the class, creates a class instance, and adds the instance to the full-speed and high-speed configurations. Refer to the chapter(s) of the class(es) you purchased for more details about the class demos.

usbd_cfg.h is a configuration file used to setup μ C/USB-Device stack parameters such as the maximum number of configurations, interfaces, or class-related parameters.

usbd_dev_cfg.c and **usbd_dev_cfg.h** are configuration files used to set device parameters such as vendor ID, product ID, and device release number. They also serve to configure the USB device controller driver parameters, such as base address, dedicated memory base address and size, controller's speed, and endpoint capabilities.

MODIFY DEVICE CONFIGURATION

Modify the device configuration file (**usbd_cfg.c**) as needed for your application. See below for details.

```

USBDEVCFG USBDevCfg_Template = {           (1)
    0xFFFF,                                (2)
    0x1234,
    0x0100,
    "OEM MANUFACTURER",                    (3)
    "OEM PRODUCT",
    "1234567890ABCDEF",
    USBDEVCFG_LANG_ID_ENGLISH_US           (4)
};

```

Listing 2-1 Device Configuration Template

- L2-1(1) Give your device configuration a meaningful name by replacing the word **“Template”**.
- L2-1(2) Assign the Vendor ID, Product ID and Device Release Number. For development purposes you can use the default values, but once you decide to release your product, you must contact USB-IF in order to get valid IDs. USB-IF maintains all USB Vendor ID and Product ID numbers.
- L2-1(3) Specify human readable Vendor ID, Product ID, and Device Release Number strings.
- L2-1(4) A USB device can store strings in multiple languages. Specify the language used in your strings. The #defines for the other languages are defined in the file **usbd_core.h** in the section “Language Identifiers”.

MODIFY DRIVER CONFIGURATION

Modify the driver configuration (`usbd_dev_cfg.c`) as needed for your controller. See Listing 2-2 below for details.

```

USB_DrvCFG USBD_DrvCfg_Template = {                               (1)
    0x00000000,                                                  (2)
    0x00000000,                                                  (3)
    0u,
    USBD_DEV_SPD_FULL,                                          (4)
    USB_DrvEP_InfoTbl_Template                                (5)
};

```

Listing 2-2 **Driver Configuration Template**

- L2-2(1) Give your driver configuration a meaningful name by replacing the word “**Template**”.
- L2-2(2) Specify the base address of your USB device controller.
- L2-2(3) If your target has dedicated memory for the USB controller, you can specify its base address and size here. Depending on the USB controller, dedicated memory can be used to allocate driver buffers or DMA descriptors.
- L2-2(4) Specify the USB device controller speed: `USB_D_DEV_SPD_HIGH` if your controller supports high-speed or `USB_D_DEV_SPD_FULL` if your controller supports only full-speed.
- L2-2(5) Specify the endpoint information table. The endpoint information table should be defined in your USB device controller BSP files. Refer to section 6-5-1 “Endpoint Information Table” on page 86 for more details about the endpoint information table.

MODIFY USB APPLICATION INITIALIZATION CODE

Listing 2-3 shows the code that you should modify based on your specific configuration done previously. You should modify the parts that are highlighted by the bold text. The code snippet is extracted from the function `App_USBD_Init()` defined in `app_usbd.c`. The complete initialization sequence performed by `App_USBD_Init()` is presented in Listing 2-5.

```

#include <usbd_bsp_template.h>                                     (1)

CPU_BOOLEAN App_USBD_Init (void)
{
    CPU_INT08U dev_nbr;
    CPU_INT08U cfg_fs_nbr;
    USBD_ERR    err;

    USBD_Init(&err);                                             (2)

    dev_nbr = USBD_DevAdd(&USB_DevCfg_Template,                 (3)
                          &App_USBD_BusFncts,
                          &USB_DrvAPI_Template,               (4)
                          &USB_DrvCfg_Template,                (5)
                          &USB_DrvBSP_Template,                (6)
                          &err);

    if (USB_DrvCfg_Template.Spd == USBD_DEV_SPD_HIGH) {        (7)

        cfg_hs_nbr = USBD_CfgAdd( dev_nbr,
                                   USBD_DEV_ATTRIB_SELF_POWERED,
                                   100u,
                                   USBD_DEV_SPD_HIGH,
                                   "HS configuration",
                                   &err);

    }
    ....
}

```

Listing 2-3 **App_USBD_Init()** in **app_usbd.c**

L2-3(1) Include the USB driver BSP header file that is specific to your board. This file can be found in the following folder:

```
\Micrium\Software\uC-USB-Device\Drivers\<<controller>\BSP\<<board name>
```

L2-3(2) Initialize the USB device stack's internal variables, structures and core RTOS port.

L2-3(3) Specify the address of the device configuration structure that you modified in the section “Modify Device Configuration” on page 34.

- L2-3(4) Specify the address of the driver API structure. The driver's API structure is defined in the driver's header file named `usbd_drv_<controller>.h`.
- L2-3(5) Specify the address of the driver configuration structure that you modified in the section "Modify Driver Configuration" on page 35.
- L2-3(6) Specify the endpoint information table. The endpoint information table should be defined in your USB device controller BSP files.
- L2-3(7) If the device controller supports high-speed, create a high-speed configuration for the specified device.

2-4-3 INCLUDING USB DEVICE STACK SOURCE CODE

First, include the following files in your project from the μ C/USB-Device source code distribution, as indicated in Figure 2-3.



Figure 2-3 μ C/USB-Device Source Code

Second, add the following include paths to your project settings:

```
\Micrium\Software\uC-USB-Device\Source\  
\Micrium\Software\uC-USB-Device\Class\<class>\  
\Micrium\Software\uC-USB-Device\Drivers\<controller>\  
\Micrium\Software\uC-USB-Device\Drivers\<controller>\BSP\<board name>
```

2-4-4 MODIFYING APPLICATION CONFIGURATION FILE

The USB application initialization code templates assume the presence of `app_cfg.h`. The following `#defines` must be present in `app_cfg.h` in order to build the sample application.

```
#define APP_CFG_USBD_EN                DEF_ENABLED           (1)  
  
#define USBD_OS_CFG_CORE_TASK_PRIO      6u                 (2)  
#define USBD_OS_CFG_TRACE_TASK_PRIO     7u  
#define USBD_OS_CFG_CORE_TASK_STK_SIZE  256u  
#define USBD_OS_CFG_TRACE_TASK_PRIO     256u  
  
#define APP_CFG_USBD_XXXX_EN            DEF_ENABLED           (3)  
  
#define LIB_MEM_CFG_OPTIMIZE_ASM_EN     DEF_DISABLED        (4)  
#define LIB_MEM_CFG_ARG_CHK_EXT_EN     DEF_ENABLED  
#define LIB_MEM_CFG_ALLOC_EN           DEF_ENABLED  
#define LIB_MEM_CFG_HEAP_SIZE           1024u  
  
#define TRACE_LEVEL_OFF                  0u                 (5)  
#define TRACE_LEVEL_INFO                 1u  
#define TRACE_LEVEL_DBG                  2u  
  
#define APP_CFG_TRACE_LEVEL              TRACE_LEVEL_DBG     (6)  
#define APP_CFG_TRACE                    printf              (7)  
  
#define APP_TRACE_INFO(x)  \\  
((APP_CFG_TRACE_LEVEL >= TRACE_LEVEL_INFO) ? (void)(APP_CFG_TRACE x) : (void)0)  
#define APP_TRACE_DBG(x)  \\  
((APP_CFG_TRACE_LEVEL >= TRACE_LEVEL_DBG) ? (void)(APP_CFG_TRACE x) : (void)0)
```

Listing 2-4 Application Configuration #defines

-
- L2-4(1) `APP_CFG_USBD_EN` enables or disables the USB application initialization code.
- L2-4(2) These `#defines` relate to the μ C/USB-Device OS port. The μ C/USB-Device core requires only one task to manage control requests and asynchronous transfers, and a second, optional task to output trace events (if trace capability is enabled). To properly set the priority of the core and debug tasks, refer to section 5-2-1 “Task Priorities” on page 69.
- L2-4(3) This `#define` enables the USB class-specific demo. The token `XXXX` in the constant `APP_CFG_USBD_XXXX_EN` is the name of the class and can be replaced by `CDC`, `HID`, `MSC`, `PHDC` or `VENDOR`.
- L2-4(4) Configure the desired size of the heap memory. Heap memory is only used for μ C/USB-Device drivers that use internal buffers and DMA descriptors which are allocated at run-time. Refer to the μ C/LIB documentation for more details on the other μ C/LIB constants.
- L2-4(5) Most Micrium examples contain application trace macros to output human-readable debugging information. Two levels of tracing are enabled: `INFO` and `DBG`. `INFO` traces high-level operations, and `DBG` traces high-level operations and return errors. Application-level tracing is different from μ C/USB-Device tracing (refer to Chapter 13, “Debug and Trace” on page 231 for more details).
- L2-4(6) Define the application trace level.
- L2-4(7) Specify which function should be used to redirect the output of human-readable application tracing. You can select the standard output via `printf()`, or another output such as a text terminal using a serial interface.

2-5 RUNNING THE SAMPLE APPLICATION

The first step to integrate the demo application into your application code is to call `App_USBD_Init()`. This function is responsible for the following steps:

- Initializing the USB device stack.
- Creating and adding a device instance.
- Creating and adding configurations.
- Calling USB class-specific application code.
- Starting the USB device stack.

The `App_USBD_Init()` function is described in Listing 2-5.

```
CPU_BOOLEAN App_USBD_Init (void)
{
    CPU_INT08U dev_nbr;
    CPU_INT08U cfg_hs_nbr;
    CPU_INT08U cfg_fs_nbr;
    CPU_BOOLEAN ok;
    USBD_ERR err;

    USBD_Init(&err);                                (1)
    if (err!= USBD_ERR_NONE) {
        /* $$$$ Handle error. */
        return (DEF_FAIL);
    }

    dev_nbr = USBD_DevAdd(&USBDevCfg_<controller>,    (2)
                        &App_USBD_BusFncts,
                        &USB_DrvAPI_<controller>,
                        &USB_DrvCfg_<controller>,
                        &USB_DrvBSP_<board name>,
                        &err);
    if (err != USBD_ERR_NONE) {
        /* $$$$ Handle error. */
        return (DEF_FAIL);
    }

    cfg_hs_nbr = USBD_CFG_NBR_NONE;
    cfg_fs_nbr = USBD_CFG_NBR_NONE;
```



```

if (USBD_DrvCfg_<controller>.Spd == USBDEV_SPD_HIGH) {

    cfg_hs_nbr = USBD_CfgAdd( dev_nbr,                                (3)
                             USBDEV_ATTRIB_SELF_POWERED,
                             100u,
                             USBDEV_SPD_HIGH,
                             "HS configuration",
                             &err);
    if (err != USBDEV_ERR_NONE) {
        /* $$$ Handle error. */
        return (DEF_FAIL);
    }
}

cfg_fs_nbr = USBD_CfgAdd( dev_nbr,                                (4)
                          USBDEV_ATTRIB_SELF_POWERED,
                          100u,
                          USBDEV_SPD_FULL,
                          "FS configuration",
                          &err);
if (err != USBDEV_ERR_NONE) {
    /* $$$ Handle error. */
    return (DEF_FAIL);
}

#if (APP_CFG_USBD_XXXX_EN == DEF_ENABLED)                          (5)
    ok = App_USBD_XXXX_Init(dev_nbr,
                             cfg_hs_nbr,
                             cfg_fs_nbr);
    if (ok != DEF_OK) {
        /* $$$ Handle error. */
        return (DEF_FAIL);
    }
#endif

#if (APP_CFG_USBD_XXXX_EN == DEF_ENABLED)                          (5)
    .
    .
    .
endif

    USBD_DevStart(dev_nbr, &err);                                  (6)

    (void)ok;
    return (DEF_OK);
}

```

Listing 2-5 App_USBD_Init() Function

- L2-5(1) `USBD_Init()` initializes the USB device stack. This must be the first USB function called by your application's initialization code. If `µC/USB-Device` is used with `µC/OS-II` or `-III`, `OSInit()` must be called prior to `USBD_Init()` in order to initialize the kernel services.
- L2-5(2) `USBD_DevAdd()` creates and adds a USB device instance. A given USB device instance is associated with a single USB device controller. `µC/USB-Device` can support multiple USB device controllers concurrently. If your target supports multiple controllers, you can create multiple USB device instances for them. The function `USBD_DevAdd()` returns a device instance number; this number is used as a parameter for all subsequent operations.
- L2-5(3) Create and add a high-speed configuration to your device. `USBD_CfgAdd()` creates and adds a configuration to the USB device stack. At a minimum, your USB device application only needs one full-speed and one high-speed configuration if your device is a high-speed capable device. For a full-speed device, only a full-speed configuration will be required. You can create as many configurations as needed by your application, and you can associate multiple instances of USB classes to these configurations. For example, you can create a configuration to contain a mass storage device, and another configuration for a human interface device such as a keyboard, and a vendor specific device.
- L2-5(4) Create and add a full-speed configuration to your device.
- L2-5(5) Initialize the class-specific application demos by calling the function `App_USBD_XXXX_Init()` where `XXXX` can be `CDC`, `HID`, `MSC`, `PHDC` or `VENDOR`. Class-specific demos are enabled and disabled using the `APP_CFG_USB_XXXX_EN` #define.
- L2-5(6) After all the class instances are created and added to the device configurations, the application should call `USBD_DevStart()`. This function connects the device with the host by enabling the pull-up resistor on the D+ line.

Table 2-2 lists the sections you should refer to for more details about each `App_USBD_XXXX_Init()` function.

Class	Function	Refer to...
CDC ACM	<code>App_USBD_CDC_Init()</code>	section 8-3-1 “General Configuration” on page 120
HID	<code>App_USBD_HID_Init()</code>	section 9-3-2 “Class Instance Configuration” on page 144
MSC	<code>App_USBD_MSC_Init()</code>	section 10-4-2 “Class Instance Configuration” on page 174
PHDC	<code>App_USBD_PHDC_Init()</code>	section 11-2-2 “Class instance configuration” on page 189
Vendor	<code>App_USBD_Vendor_Init()</code>	section 12-2-2 “Class Instance Configuration” on page 208

Table 2-2 **List of Sections to Refer to for Class Demos Information**

After building and downloading the application into your target, you should be able to successfully connect your target to a host PC through USB. Once the USB sample application is running, the host detects the connection of a new device and starts the enumeration process. If you are using a Windows PC, it will load a driver which will manage your device. If no driver is found for your device, Windows will display “found new hardware” wizard so that you can specify which driver to load. Once the driver is loaded, your device is ready for communication. Table 2-3 lists the different section(s) you should refer to for more details on each class demo.

Class	Refer to...
CDC ACM	section 8-4-6 “Using the Demo Application” on page 129
HID	section 9-4 “Using the Demo Application” on page 154
MSC	section 10-5 “Using the Demo Application” on page 176
PHDC	section 11-5 “Using the Demo Application” on page 200
Vendor	section 12-4 “Using the Demo Application” on page 220

Table 2-3 **List of Sections to Refer to for Class Demos Information**

Host Operating Systems

The major host operating systems (OS), such as Microsoft Windows, Apple Mac OS and Linux, recognize a wide range of USB devices belonging to standard classes defined by the USB Implementers Forum. Upon connection of the USB device, any host operating systems perform the following general steps:

- 1 Enumerating the USB device to learn about its characteristics.
- 2 Loading a proper driver according to its characteristics' analysis in order to manage the device.
- 3 Communicating with the device.

Step 2, where a driver is loaded to handle the device is performed differently by each major host operating system. Usually, a native driver provided by the operating system manages a device complying to a standard class (for instance, Audio, HID, MSC, Video, etc.) In this case, the native driver loading is transparent to you. In general, the OS won't ask you for specific actions during the driver loading process. On the other hand, a vendor-specific device requires a vendor-specific driver provided by the device manufacturer. Vendor-specific devices don't fit into any standard class or don't use the standard protocols for an existing standard class. In this situation, the OS may explicitly ask your intervention during the driver loading process.

During step 3, your application may have to find the USB device attached to the OS before communication with it. Each major OS uses a different method to allow you to find a specific device.

This chapter gives you the necessary information in case your intervention is required during the USB device driver loading and in case your application needs to find a device attached to the computer. For the moment, this chapter describes this process only for the Windows operating system.

3-1 MICROSOFT WINDOWS

Microsoft offers class drivers for some standard USB classes. These drivers can also be called native drivers. A complete list of the native drivers can be found in the MSDN online documentation on the page titled “Drivers for the Supported USB Device Classes” ([http://msdn.microsoft.com/en-us/library/ff538820\(VS.85\).aspx](http://msdn.microsoft.com/en-us/library/ff538820(VS.85).aspx)). If a connected device belongs to a class for which a native driver exists, Windows automatically loads the driver without any additional actions from you. If a vendor-specific driver is required for the device, a manufacturer’s INF file giving instructions to Windows for loading the vendor-specific driver is required. In some cases, a manufacturer’s INF file may also be required to load a native driver.

When the device has been recognized by Windows and is ready for communication, your application may need to use a Globally Unique Identifier (GUID) to retrieve a device handle that allows your application to communicate with the device.

These sections explain the use of INF files and GUIDs. Table 3-1 shows the USB classes to which the information in the following sub-sections applies.

Section	Micrijum classes
section 3-1-1 “About INF Files” on page 46	CDC, PHDC and Vendor
section 3-1-2 “Using GUIDs” on page 51	HID, PHDC and Vendor.

Table 3-1 **Micrijum Classes Concerned by Windows USB Device Management**

3-1-1 ABOUT INF FILES

An INF file is a setup information file that contains information used by Windows to install software and drivers for one or more devices. The INF file also contains information to store in the registry. Each of the drivers provided natively with the operating system has an associated INF file stored in `C:\WINDOWS\inf`. For instance, when a HID or MSC device is connected to the PC, Windows enumerates the device and implicitly finds an INF file associated to a HID or MSC class that permits loading the proper driver. INF files for native drivers are called system INF files. Any new INF files provided by manufacturers for vendor-specific devices are copied into the folder `C:\WINDOWS\inf`. These INF files can be called vendor-specific INF files. An INF file allows Windows to load one or more drivers for a device. A driver can be native or provided by the device manufacturer.

Table 3-2 shows the Windows driver(s) loaded for each Micrium class:

Micrium class	Windows driver	Driver type	INF file type
CDC ACM	usbser.sys	Native	Vendor-specific INF file
HID	Hidclass.sys Hidusb.sys	Native	System INF file
MSC	Usbstor.sys	Native	System INF file
PHDC	winusb.sys (for getting started purpose only).	Native	Vendor-specific INF file
Vendor	winusb.sys	Native	Vendor-specific INF file

Table 3-2 Windows Drivers Loaded for each Micrium Class

When a device is first connected, Windows searches for a match between the information contained in system INF files and the information retrieved from device descriptors. If there is no match, Windows asks you to provide an INF file for the connected device.

An INF file is arranged in sections whose names are surrounded by square brackets []. Each section contains one or several entries. If the entry has a predefined keyword such as "Class", "Signature", etc, the entry is called a directive. Listing 3-1 presents an example of an INF file structure:

```

; ===== Version section =====
[Version]                                     (1)
Signature = "$Windows NT$"
Class     = Ports
ClassGuid = {4D36E978-E325-11CE-BFC1-08002BE10318}

Provider=%ProviderName%
DriverVer=01/01/2012,1.0.0.0

; ===== Manufacturer/Models sections =====

[Manufacturer]                               (2)
%ProviderName% = DeviceList, NTx86, NTamd64

[DeviceList.NTx86]                           (3)
%PROVIDER_CDC% = DriverInstall, USB\VID_fffe&PID_1234&MI_00

```

```

[DeviceList.NTamd64]                                     (3)
%PROVIDER_CDC% = DriverInstall, USB\VID_fffe&PID_1234&MI_00

; ===== Installation sections =====              (4)

[DriverInstall]
include = mdmcpq.inf
CopyFiles = FakeModemCopyFileSection
AddReg = LowerFilterAddReg,SerialPropPageAddReg

[DriverInstall.Services]
include = mdmcpq.inf
AddService = usbser, 0x00000002, LowerFilter_Service_Inst

[SerialPropPageAddReg]
HKR,,EnumPropPages32,, "MsPorts.dll,SerialPortPropPageProvider"

; ===== Strings section =====

[Strings]                                               (5)
ProviderName = "Micrium"
PROVIDER_CDC = "Micrium CDC Device"

```

Listing 3-1 Example of INF File Structure

- L3-1(1) The section **[Version]** is mandatory and informs Windows about the provider, the version and other descriptive information about the driver package.
- L3-1(2) The section **[Manufacturer]** is mandatory. It identifies the device's manufacturer.
- L3-1(3) The following two sections are called Models sections and are defined on a per-manufacturer basis. They give more detailed instructions about the driver(s) to install for the device(s). A section name can use extensions to specify OSes and/or CPUs the entries apply to. In this example, **.NTx86** and **.NTamd64** indicate that the driver can be installed on an NT-based Windows (that is Windows 2000 and later), on x86- and x64-based PC respectively.
- L3-1(4) The installation sections actually install the driver(s) for each device described in the Model section(s). The driver installation may involve reading existing information from the Windows registry, modifying existing entries of the registry or creating new entries into the registry.

L3-1(5) The section **[Strings]** is mandatory and it is used to define each string key token indicated by `%string name%` in the INF file.

Refer to the MSDN online documentation on this web page for more details about INF sections and directives: <http://msdn.microsoft.com/en-us/library/ff549520.aspx>.

You will be able to modify some sections in order to match the INF file to your device characteristics, such as Vendor ID, Product ID and human-readable strings describing the device. The sections are:

- Models section
- **[Strings]** section

To identify possible drivers for a device, Windows looks in the Models section for a *device identification string* that matches a string created from information in the device's descriptors. Every USB device has a device ID, that is a *hardware ID* created by the Windows USB host stack from information contained in the Device descriptor. A device ID has the following form:

```
USB\Vid_XXXX&Pid_YYYY
```

`XXXX`, `YYYY`, represent the value of the Device descriptor fields "idVendor" and "idProduct" respectively (refer to the Universal Serial Bus Specification, revision 2.0, section 9.6.1 for more details about the Device descriptor fields). This string allows Windows to load a driver for the device. You can modify `XXXX` and `YYYY` to match your device's Vendor and Product IDs. In Listing 2-1, the hardware ID defines the Vendor ID `0xFFFFE` and the Product ID `0x1234`.

Composite devices, formed of several functions, can specify a driver for each function. In this case, the device has a device ID for each interface that represents a function. A device ID for an interface has the following form:

```
USB\Vid_XXXX&Pid_YYYY&MI_ww
```

ww is equal to the “bInterfaceNumber” field in the Interface descriptor (refer to the Universal Serial Bus Specification, revision 2.0, section 9.6.5 for more details on the Interface descriptor fields). You can modify ww to match the position of the interface in the Configuration descriptor. If the interface has the position #2 in the Configuration descriptor, ww is equal to 02.

The [Strings] section contains a description of your device. In Listing 3-1, the strings define the name of the device driver package provider and the device name. You can see these device description strings in the Device Manager. For instance, Figure 3-1 shows a virtual COM port created with the INF file from Listing 3-1. The string “Micrium” appears under the “Driver Provider” name in the device properties. The string “Micrium CDC Device” appears under the “Ports” group and in the device properties dialog box.



Figure 3-1 Windows Device Manager Example for a CDC Device

3-1-2 USING GUIDS

A Globally Unique Identifier (GUID) is a 128-bit value that uniquely identifies a class or other entity. Windows uses GUIDs for identifying two types of device classes:

- Device setup class
- Device interface class

A device setup GUID encompasses devices that Windows installs in the same way and using the same class installer and co-installers. Class installers and co-installers are DLLs that provide functions related to device installation. There is a GUID associated with each device setup class. System-defined setup class GUIDs are defined in `devguid.h`. The device setup class GUID defines the `.. \CurrentControlSet \Control \Class \ClassGuid` registry key under which to create a new subkey for any particular device of a standard setup class. A complete list of system-defined device setup classes offered by Microsoft Windows® is available on MSDN online documentation ([http://msdn.microsoft.com/en-us/library/windows/hardware/ff553426\(v=vs.85\).aspx](http://msdn.microsoft.com/en-us/library/windows/hardware/ff553426(v=vs.85).aspx)).

A device interface class GUID provides a mechanism for applications to communicate with a driver assigned to devices in a class. A class or device driver can register one or more device interface classes to enable applications to learn about and communicate with devices that use the driver. Each device interface class has a device interface GUID. Upon a device's first attachment to the PC, the Windows I/O manager associates the device and the device interface class GUID with a symbolic link name, also called a device path. The device path is stored in the registry and persists across system reboot. An application can retrieve all the connected devices within a device interface class. If the application has gotten a device path for a connected device, this device path can be passed to a function that will return a handle. This handle is passed to other functions in order to communicate with the corresponding device.

Three of Micrium's USB classes are provided with Visual Studio 2010 projects. These Visual Studio projects build applications that interact with a USB device. They use a device interface class GUID to detect any attached device belonging to the class. Table 3-3 shows the Micrium class and the corresponding device interface class GUID used in the class Visual Studio project.

Micrium class	Device interface class GUID	Defined in
HID	{4d1e55b2-f16f-11cf-88cb-001111000030}	app_hid_common.h
PHDC	{143f20bd-7bd2-4ca6-9465-8882f2156bd6}	usbdev_guid.h
Vendor	{143f20bd-7bd2-4ca6-9465-8882f2156bd6}	usbdev_guid.h

Table 3-3 **Micrium Class and Device Interface Class GUID**

The interface class GUID for the HID class is provided by Microsoft as part of system-defined device interface classes, whereas the interface class GUID for PHDC and Vendor classes has been generated with Visual Studio 2010 using the utility tool, **guidgen.exe**. This tool is accessible from the menu Tools and the option Create GUID or, through the command-line by selecting the menu Tools, option Visual Studio Command Prompt and by typing **guidgen** at the prompt.

Chapter

4

Architecture

μ C/USB-Device was designed to be modular and easy to adapt to a variety of Central Processing Units (CPUs), Real-Time Operating Systems (RTOS), USB device controllers, and compilers.

Figure 4-1 shows a simplified block diagram of all the μ C/USB-Device modules and their relationships.



Figure 4-1 μC/USB-Device Architecture Block Diagram

4-1 MODULES RELATIONSHIP

4-1-1 APPLICATION

Your application layer needs to provide configuration information to μ C/USB-Device in the form of four C files: `app_cfg.h`, `usbd_cfg.h`, `usbd_dev_cfg.c` and `usbd_dev_cfg.h`:

- `app_cfg.h` is an application-specific configuration file. It contains `#defines` to specify task priorities and the stack size of each of the task within the application and the task required by μ C/USB-Device. Some small Micrium modules like μ C/LIB (run-time library) use `app_cfg.h` to configure parameters such as the heap size.
- Configuration data in `usbd_cfg.h` consists of specifying the number of devices supported in the stack, the maximum number of configurations, the maximum number of interfaces and alternate interfaces, maximum number of opened endpoints per device, class-specific configuration parameters and more. In all, there are approximately 20 `#defines` to set.
- Finally, `usbd_dev_cfg.c/.h` consists of device-specific configuration requirements such as vendor ID, product ID, device release number and its respective strings. It also contains device controller specific configurations such as base address, dedicated memory base address and size, and endpoint management table.

Refer to Chapter 5, “Configuration” on page 65 for more information on how to configure μ C/USB-Device.

4-1-2 LIBRARIES

Given that μ C/USB-Device is designed to be used in safety critical applications, some of the “standard” library functions such as `strcpy()`, `memset()`, etc. have been rewritten to conform to the same quality standards as the rest of the USB device stack. All these standard functions are part of a separate Micrium’s product, μ C/LIB. μ C/USB-Device depends on this product. In addition, some data objects in USB controller drivers are created at run-time which implies the use of memory allocation from the heap function `Mem_HeapAlloc()`.

4-1-3 USB CLASS LAYER

Your application will interface with μ C/USB-Device using the class layer API. In this layer, four classes defined by the USB-IF are implemented. In case you need to implement a vendor-specific class, a fifth class, the “vendor” class, is available. This class provides functions for simple communication via endpoints. The classes that μ C/USB-Device currently supports are the following:

- Communication Device Class (CDC)
 - CDC Abstract Control Model (ACM) subclass
- Human Interface Device Class (HID)
- Mass Storage Class (MSC)
- Personal Healthcare Device Class (PHDC)
- Vendor Class

You can also create other classes defined by the USB-IF. Refer to Chapter 7, “USB Classes” on page 99 for more information on how a USB class interacts with the core layer.

4-1-4 USB CORE LAYER

USB core layer is responsible for creating and maintaining the logical structure of a USB device. The core layer manages the USB configurations, interfaces, alternate interfaces and allocation of endpoints based on the application or USB classes requirements and the USB controller endpoints available. Standard requests, bus events (reset, suspend, connect and disconnect) and enumeration process are also handled by the Core layer.

4-1-5 ENDPOINT MANAGEMENT LAYER

The endpoint management layer is responsible for sending and receiving data using endpoints. Control, interrupt and bulk transfers are implemented in this layer. This layer provides synchronous API for control, bulk and interrupt I/O operations and asynchronous API for bulk and interrupt I/O operations.

4-1-6 REAL-TIME OPERATING SYSTEM (RTOS) ABSTRACTION LAYER

μ C/USB-Device assumes the presence of a RTOS, and a RTOS abstraction layer allows μ C/USB-Device to be independent of a specific RTOS. The RTOS abstraction layer is composed of several RTOS ports, a core layer port and some class layer ports.

CORE LAYER PORT

At the very least, the RTOS for the core layer:

- Create at least one task for the core operation and one optional task for the debug trace feature.
- Provide semaphore management (or the equivalent). Semaphores are used to signal completion or error in synchronous I/O operations and trace events.
- Provide queue management for I/O and bus events.

μ C/USB-Device is provided with ports for μ C/OS-II and μ C/OS-III. If a different RTOS is used, you can use the files for μ C/OS-II or μ C/OS-III as template to interface to the RTOS chosen. For more information on how to port μ C/USB-Device to a RTOS, see Chapter 14, “Porting μ C/USB-Device to your RTOS” on page 237.

CLASS LAYER PORTS

Some classes requires a RTOS port (i.e., MSC, PHDC and HID). Refer to Table 14-2 on page 239 for a list of sections containing more informations on the RTOS port of each of these classes.

4-1-7 HARDWARE ABSTRACTION LAYER

μ C/USB-Device works with nearly any USB device controller. This layer handles the specifics of the hardware, e.g., how to initialize the device, how to open and configure endpoints, how to start reception and transmission of USB packets, how to read and write USB packets, how to report USB events to the core, etc. The USB device driver controller functions are encapsulated and implemented in the `usbd_drv_<controller>.c` file.

In order to have independent configuration for clock gating, interrupt controller and general purpose I/O, a USB device controller driver needs an additional file. This file is called a Board Support Package (BSP). The name of this file is `usbd_bsp_<controller>.c`. This file contains all the details that are closely related to the hardware on which the product is used. This file also defines the endpoints information table. This table is used by the core layer to allocate endpoints according to the hardware capabilities.

4-1-8 CPU LAYER

μ C/USB-Device can work with either an 8, 16, 32 or even 64-bit CPU, but it must have information about the CPU used. The CPU layer defines such information as the C data type corresponding to 16-bit and 32-bit variables, whether the CPU has little or big endian memory organization, and how interrupts are disabled and enabled on the CPU.

CPU-specific files are found in the `\uC-CPU` directory and are used to adapt μ C/USB-Device to a different CPU.

4-2 TASK MODEL

μ C/USB-Device requires two tasks: One core task and one optional task for tracing debug events. The core task has three main responsibilities:

- Process USB bus events: Bus events such as reset, suspend, connect and disconnect are processed by the core task. Based on the type of bus event, the core task sets the state of the device.
- Process USB requests: USB requests are sent by the host using the default control endpoint. The core task processes all USB requests. Some requests are handled by the USB class driver, for those requests the core calls the class-specific request handler.
- Process I/O asynchronous transfers: Asynchronous I/O transfers are handled by the core. Under completion, the core task invokes the respective callback for the transfer.

Figure 4-2 shows a simplified task model of μ C/USB-Device along with application tasks.

Figure 4-2 $\mu\text{C}/\text{USB}$ -Device Task Model

4-2-1 SENDING AND RECEIVING DATA

Figure 4-3 shows a simplified task model of $\mu\text{C}/\text{USB}$ -Device when data is transmitted and received through the USB device controller. With $\mu\text{C}/\text{USB}$ -Device, data can be sent asynchronously or synchronously. In a synchronous operation, the application blocks execution until the transfer operation completes, or an error or a time-out has occurred. In an asynchronous operation, the application does not block. The core task notifies the application when the transfer operation has completed through a callback function.



Figure 4-3 Sending and Receiving a Packet

F4-3(1) An application task that wants to receive or send data interfaces with μ C/USB-Device through the USB classes API. The USB classes API interface with the core API and the core interfaces with the endpoint layer API.

F4-3(2) The endpoint layer API prepares the data depending on the endpoint characteristics.

F4-3(3) When the USB device controller is ready, the driver prepares the transmission or the reception.

-
- F4-3(4) Once the transfer has completed, the USB device controller generates an interrupt. Depending of the operation (transmission or reception) the USB device controller's driver ISR invokes the transmit complete or receive complete function from the core.
- F4-3(5) If the operation is synchronous, the transmit or receive complete function will signal the transfer ready counting semaphore. If the operation is asynchronous, the transmit or receive complete function will put a message in the USB core event queue for deferred processing by the USB core task.
- F4-3(6) If the operation is synchronous, the endpoint layer will wait on the counting semaphore. The operation repeats steps 2 to 5 until the whole transfer has completed.
- F4-3(7) The core task waits on events to be put in the core event queue. In asynchronous transfers, the core task will call the endpoint layer until the operation is completed.
- F4-3(8) In asynchronous mode, after the transfer has completed the core task will call the application completion callback to notify the end of the I/O operation.

4-2-2 PROCESSING USB REQUESTS AND BUS EVENTS

USB requests are processed by the core task. Figure 4-4 shows a simplified task diagram of a USB request processing. USB bus events such as reset, resume, connect, disconnect, and suspend are processed in the same way as the USB requests. The core process the USB bus events to modify and update the current state of the device.

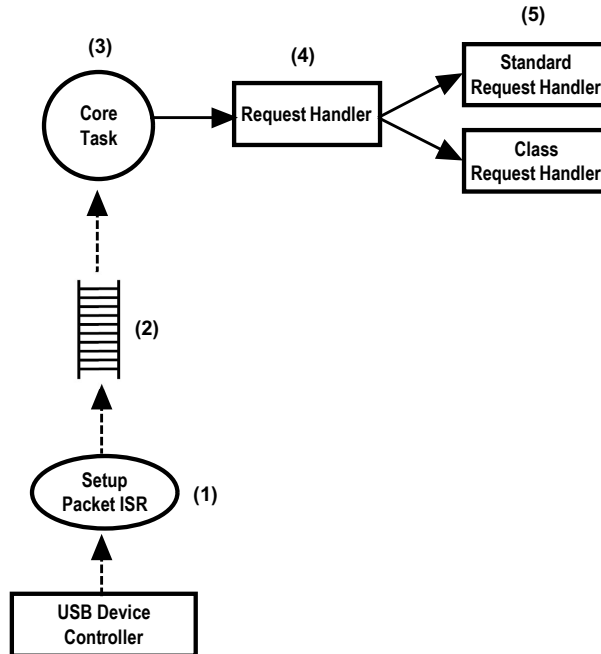

Figure 4-4 Processing USB Requests

- F4-4(1) USB requests are sent using control transfers. During the setup stage of the control transfer, the USB device controller generates an interrupt to notify the driver that a new setup packet has arrived.
- F4-4(2) The USB device controller driver ISR notifies the core by pushing the event in the core event queue.
- F4-4(3) The core task receives the message from the queue, and starts the parsing of the USB request by calling the request handler.
- F4-4(4) The request handler analyzes the request type and determines if the request is a standard, vendor or class specific request.
- F4-4(5) Standard requests are processed by the core layer. Vendor and class specific requests are processed by the class driver, in the class layer.

4-2-3 PROCESSING DEBUG EVENTS

μ C/USB-Device contains an optional debug and trace feature. Debug events are managed in the core layer using a dedicated task. Figure 4-5 describes how the core manage the debug events.



Figure 4-5 Processing USB Debug Events

- F4-5(1) The debug and trace module in the core contains a free list of USB debug events. The debug events objects contain useful information such as the endpoint number, interface number or the layer that generates the events.
- F4-5(2) Multiple μ C/USB-Device layers take available debug event objects to trace useful information about different USB related events.
- F4-5(3) Trace and debug information events are pushed in the debug event `list.ggg`
- F4-5(4) The debug task is dormant until a new debug event is available in the debug event list. The debug task will parse the information contained in the debug event object and it will output it in a human readable format using the application specific output trace function `USBD_Trace()`.
- F4-5(5) The application specific output function outputs the debug trace information.

For more information on the debug and trace module, see Chapter 13, “Debug and Trace” on page 231.

Prior to usage, μ C/USB-Device must be properly configured. There are three groups of configuration parameters:

- Static stack configuration
- Application specific configuration
- Device and device controller driver configuration

This chapter explains how to setup all these groups of configuration. The last section of this chapter also provides examples of configuration following examples of typical usage.

5-1 STATIC STACK CONFIGURATION

μ C/USB-Device is configurable at compile time via approximately 20 **#defines** in the application's copy of `usbd_cfg.h`. μ C/USB-Device uses **#defines** when possible because they allow code and data sizes to be scaled at compile time based on enabled features and the configured number of USB objects. This allows the Read-Only Memory (ROM) and Random-Access Memory (RAM) footprints of μ C/USB-Device to be adjusted based on application requirements.

It is recommended that the configuration process begins with the recommended or default configuration values which in the next sections will be shown in **bold**.

The sections in this chapter are organized following the order in μ C/USB-Device's template configuration file, `usbd_cfg.h`.

5-1-1 GENERIC CONFIGURATION

USBD_CFG_OPTIMIZE_SPD

Selected portions of μ C/USB-Device code may be optimized for either better performance or for smallest code size by configuring `USBD_CFG_OPTIMIZE_SPD`:

`DEF_ENABLED` Optimizes μ C/USB-Device for best speed performance

`DEF_DISABLED` Optimizes μ C/USB-Device for best binary image size

USBD_CFG_MAX_NBR_DEV

`USBD_CFG_MAX_NBR_DEV` configures the maximum number of devices. This value should be set to the number of device controllers used on your platform. Default value is **1**.

5-1-2 USB DEVICE CONFIGURATION

USBD_CFG_MAX_NBR_CFG

`USBD_CFG_MAX_NBR_CFG` sets the maximum number of USB configurations used by your device. Keep in mind that if you use a high-speed USB device controller, you will need at least two USB configurations, one for low and full-speed and another for high-speed. Refer to the *Universal Serial Bus specification, Revision 2.0, section 9.2.3* for more details on USB configuration. Default value is **2**.

5-1-3 INTERFACE CONFIGURATION

USBD_CFG_MAX_NBR_IF

`USBD_CFG_MAX_NBR_IF` configures the maximum number of interfaces available. This value should at least be equal to `USBD_CFG_MAX_NBR_CFG` and greatly depends on the USB class(es) used. Each class instance requires at least one interface, while CDC-ACM requires two. Refer to the *Universal Serial Bus specification, Revision 2.0, section 9.2.3* for more details on USB interfaces. Default value is **2**.

USBD_CFG_MAX_NBR_IF_ALT

USBD_CFG_MAX_NBR_IF_ALT defines the maximum number of alternate interfaces (alternate settings) available. This value should at least be equal to **USBD_CFG_MAX_NBR_IF**. Refer to the *Universal Serial Bus specification, Revision 2.0, section 9.2.3* for more details on alternate settings. Default value is **2**.

USBD_CFG_MAX_NBR_IF_GRP

USBD_CFG_MAX_NBR_IF_GRP sets the maximum number of interface groups or associations available. For the moment, Micrium offers only one USB class (CDC-ACM) that requires interface groups. Refer to the Interface Association Descriptors USB Engineering Change Notice for more details about interface associations. Default value is **0** (should be equal to the number of instances of CDC-ACM).

USBD_CFG_MAX_NBR_EP_DESC

USBD_CFG_MAX_NBR_EP_DESC sets the maximum number of endpoint descriptors available. This value greatly depends on the USB class(es) used. For information on how many endpoints are needed for each class, refer to the class specific chapter. Keep in mind that control endpoints do not need any endpoint descriptors. Default value is **2**.

USBD_CFG_MAX_NBR_EP_OPEN

USBD_CFG_MAX_NBR_EP_OPEN configures the maximum number of opened endpoints per device. If you use more than one device, set this value to the worst case. This value greatly depends on the USB class(es) used. For information on how many endpoints are needed for each class, refer to the class specific chapter. Default value is **4** (2 control plus 2 other endpoints).

5-1-4 STRING CONFIGURATION

USBD_CFG_MAX_NBR_STR

USBD_CFG_MAX_NBR_STR configures the maximum number of string descriptors supported. Default value is **3** (1 Manufacturer string, 1 product string and 1 serial number string). This value can be increased if, for example, you plan to add interface specific strings.

5-1-5 DEBUG CONFIGURATION

Configurations in this section only need to be set if you use the core debugging service. For more information on that service, see Chapter 13, “Debug and Trace” on page 231.

USBD_CFG_DBG_TRACE_EN

USBD_CFG_DBG_TRACE_EN enables or disables the core debug trace engine.

DEF_ENABLED Core debug trace engine is enabled.

DEF_DISABLED Core debug trace engine is disabled.

USBD_CFG_DBG_TRACE_NBR_EVENTS

USBD_CFG_DBG_TRACE_NBR_EVENTS indicates the maximum number of debug trace events that can be queued by the core debug trace engine. Default value is **10**.

This configuration constant has no effect and will not allocate any memory if USBD_CFG_DBG_TRACE_EN is set to DEF_DISABLED.

5-1-6 COMMUNICATION DEVICE CLASS (CDC) CONFIGURATION

For information on CDC configuration, refer to section 8-3 “Configuration” on page 120.

5-1-7 CDC ABSTRACT CONTROL MODEL (ACM) SERIAL CLASS CONFIGURATION

For information on CDC-ACM class configuration, refer to section 8-4-2 “General Configuration” on page 123.

5-1-8 HUMAN INTERFACE DEVICE (HID) CLASS CONFIGURATION

For information on HID class configuration, refer to Section 9-3, “Configuration” on page 143.

5-1-9 MASS STORAGE CLASS (MSC) CONFIGURATION

For information on MSC configuration, refer to Section 10-4, “Configuration” on page 173.

5-1-10 PERSONAL HEALTHCARE DEVICE CLASS (PHDC) CONFIGURATION

For information on PHDC configuration, refer to section 11-2 “Configuration” on page 187.

5-1-11 VENDOR CLASS CONFIGURATION

For information on vendor class configuration, refer to Section 12-2, “Configuration” on page 207.

5-2 APPLICATION SPECIFIC CONFIGURATION

This section defines the configuration constants related to μ C/USB-Device but that are application-specific. All these configuration constants relate to the RTOS. For many OSs, the μ C/USB-Device task priorities and stack sizes will need to be explicitly configured for the particular OS (consult the specific OS’s documentation for more information).

These configuration constants should be defined in an application’s `app_cfg.h` file.

5-2-1 TASK PRIORITIES

As mentioned in section 4-2 “Task Model” on page 58, μ C/USB-Device needs one core task and one optional debug task for its proper operation. The priority of μ C/USB-Device’s core task greatly depends on the USB requirements of your application. For some applications, it might be better to set it at a high priority, especially if your application requires a lot of tasks and is CPU intensive. In that case, if the core task has a low priority, it might not be able to process the bus and control requests on time. On the other hand, for some applications, you might want to give the core task a low priority, especially if you plan using asynchronous communication and if you know you will have quite a lot of code in your callback functions. For more information on the core task, see section 4-2 “Task Model” on page 58.

The priority of the debug task should generally be low since it is not critical and the task performed can be executed in the background.

For the μ C/OS-II and μ C/OS-III RTOS ports, the following macros must be configured within `app_cfg.h`:

- `USBD_OS_CFG_CORE_TASK_PRIO`
- `USBD_OS_CFG_TRACE_TASK_PRIO`

Note: if `USBD_CFG_DBG_TRACE_EN` is set to `DEF_DISABLED`, `USBD_OS_CFG_TRACE_TASK_PRIO` should not be defined.

5-2-2 TASK STACK SIZES

For the μ C/OS-II and μ C/OS-III RTOS ports, the following macros must be configured within `app_cfg.h` to set the internal task stack sizes:

- `USBD_OS_CFG_CORE_TASK_STK_SIZE` **1000**
- `USBD_OS_CFG_TRACE_TASK_STK_SIZE` **1000**

Note: if `USBD_CFG_DBG_TRACE_EN` is set to `DEF_DISABLED`, `USBD_OS_CFG_TRACE_TASK_STK_SIZE` should not be defined.

The arbitrary stack size of **1000** is a good starting point for most applications.

The only guaranteed method of determining the required task stack sizes is to calculate the maximum stack usage for each task. Obviously, the maximum stack usage for a task is the total stack usage along the task's most-stack-greedy function path plus the (maximum) stack usage for interrupts. Note that the most-stack-greedy function path is not necessarily the longest or deepest function path.

The easiest and best method for calculating the maximum stack usage for any task/function should be performed statically by the compiler or by a static analysis tool since these can calculate function/task maximum stack usage based on the compiler's actual code generation and optimization settings. So for optimal task stack configuration, we recommend to invest in a task stack calculator tool compatible with your build toolchain.

5-3 DEVICE AND DEVICE CONTROLLER DRIVER CONFIGURATION

In order to finalize the configuration of your device, you need to declare two structures, one will contain information about your device (Vendor ID, Product ID, etc.) and another that will contain information useful to the device controller driver. A reference to both of these structures needs to be passed to the `USBDevAdd()` function, which allocates a device controller.

For more information on how to modify device and device controller driver configuration, see section 2-4-2 “Copying and Modifying Template Files” on page 33.

5-4 CONFIGURATION EXAMPLES

This section provides examples of configuration for μ C/USB-Device stack based on some typical usages. This section will only give examples of static stack configuration, as the application-specific configuration greatly depends on your application. Also, the device configuration is related to your product's context, and the device controller driver configuration depends on the hardware you use.

The examples of typical usage that will be treated are the following:

- A simple full-speed USB device. This device uses Micrium's vendor class.
- A composite high-speed USB device. This device uses Micrium's PHDC and MSC classes.
- A complex composite high-speed USB device. This device uses an instance of Micrium's HID class in two different configurations plus a different instance of Micrium's CDC-ACM class in each configuration. This device also uses an instance of Micrium's vendor class in the second configuration.

5-4-1 SIMPLE FULL-SPEED USB DEVICE

Table 5-1 shows the values that should be set for the different configuration constants described earlier if you build a simple full-speed USB device using Micrium's vendor class.

Configuration	Value	Explanation
USBD_CFG_MAX_NBR_CFG	1	Since device is full speed, only one configuration is needed.
USBD_CFG_MAX_NBR_IF	1	Since device only uses the vendor class, only one interface is needed.
USBD_CFG_MAX_NBR_IF_ALT	1	No alternate interfaces are needed, but this value must at least be equal to USBD_CFG_MAX_NBR_IF.
USBD_CFG_MAX_NBR_IF_GRP	0	No interface association needed.
USBD_CFG_MAX_NBR_EP_DESC	2 or 4	Two bulk endpoints and two optional interrupt endpoints.
USBD_CFG_MAX_NBR_EP_OPEN	4 or 6	Two control endpoints for device's standard requests. Two bulk endpoints and two optional interrupt endpoints.
USBD_VENDOR_CFG_MAX_NBR_DEV	1	Only one instance of vendor class is needed.
USBD_VENDOR_CFG_MAX_NBR_CFG	1	Vendor class instance will only be used in one configuration.

Table 5-1 Configuration Example of a Simple Full-Speed USB Device

5-4-2 COMPOSITE HIGH-SPEED USB DEVICE

Table 5-2 shows the values that should be set for the different configuration constants described earlier if you build a composite high-speed USB device using Micrium's PHDC and MSC classes. The structure of this device is described in Figure 5-1.



Figure 5-1 Composite High-Speed USB Device Structure

Configuration	Value	Explanation
USBD_CFG_MAX_NBR_CFG	2	One configuration for full/low-speed and another for high-speed.
USBD_CFG_MAX_NBR_IF	4	One interface for PHDC and another for MSC. A different interface for each configuration is also needed.
USBD_CFG_MAX_NBR_IF_ALT	4	No alternate interface needed, but this value must at least be equal to USBD_CFG_MAX_NBR_IF.
USBD_CFG_MAX_NBR_IF_GRP	0	No interface association needed.
USBD_CFG_MAX_NBR_EP_DESC	4 or 5	Two bulk endpoints for MSC. Two bulk plus one optional interrupt endpoint for PHDC.
USBD_CFG_MAX_NBR_EP_OPEN	6 or 7	Two control endpoints for device's standard requests. Two bulk endpoints for MSC. Two bulk plus 1 optional interrupt endpoint for PHDC.
USBD_PHDC_CFG_MAX_NBR_DEV	1	Only one instance of PHDC is needed. It will be shared between all the configurations.
USBD_PHDC_CFG_MAX_NBR_CFG	2	PHDC instance can be used in both of device's configurations.
USBD_MSC_CFG_MAX_NBR_DEV	1	Only one instance of MSC is needed. It will be shared between all the configurations.
USBD_MSC_CFG_MAX_NBR_CFG	2	MSC instance can be used in both of device's configurations.

Table 5-2 Configuration Example of a Composite High-Speed USB Device

5-4-3 COMPLEX COMPOSITE HIGH-SPEED USB DEVICE

Table 5-3 shows the values that should be set for the different configuration constants described earlier if you build a composite high-speed USB device using a single instance of Micrium's HID class in two different configurations plus a different instance of Micrium's CDC-ACM class in each configuration. The device also uses an instance of Micrium's vendor class in its second configuration. See Figure 5-2 for a graphical description of this USB device.



Figure 5-2 Complex Composite High-Speed USB Device Structure

Configuration	Value	Explanation
USBD_CFG_MAX_NBR_CFG	4	Two configurations for full/low-speed and two others for high-speed.
USBD_CFG_MAX_NBR_IF	7	First configuration: One interface for HID. Two interfaces for CDC-ACM. Second configuration: One interface for HID. Two interfaces for CDC-ACM. One interface for vendor.
USBD_CFG_MAX_NBR_IF_ALT	7	No alternate interface needed, but this value must at least be equal to USBD_CFG_MAX_NBR_IF.
USBD_CFG_MAX_NBR_IF_GRP	2	CDC-ACM needs to group its communication and data interfaces into a single USB function. Since there are two CDC-ACM class instances, there will be two interface groups.
USBD_CFG_MAX_NBR_EP_DESC	9, 10, 11 or 12	One IN and (optional) OUT interrupt endpoint for HID. Three endpoints for first CDC-ACM class instance. Three endpoints for second CDC-ACM class instance. Two bulk plus two optional interrupt endpoints for vendor.
USBD_CFG_MAX_NBR_EP_OPEN	8, 9, 10 or 11	In the worst case (host enables second configuration): Two control endpoints for device's standard requests. One IN and (optional) OUT interrupt endpoint for HID. Three endpoints for second CDC-ACM class instance. Two bulk plus two optional interrupt endpoints for vendor.
USBD_HID_CFG_MAX_NBR_DEV	1	Only one instance of HID class is needed. It will be shared between all the configurations.
USBD_HID_CFG_MAX_NBR_CFG	4	HID class instance can be used in all of device's configurations.
USBD_CDC_CFG_MAX_NBR_DEV	2	Two CDC base class instances are used.
USBD_CDC_CFG_MAX_NBR_CFG	2	Each CDC base class instance can be used in one full-speed and one high-speed configuration.
USBD_ACM_SERIAL_CFG_MAX_NBR_DEV	2	Two ACM subclass instances are used.
USBD_VENDOR_CFG_MAX_NBR_DEV	1	Only one vendor class instance is used.
USBD_VENDOR_CFG_MAX_NBR_CFG	2	The vendor class instance can be used in one full-speed and one high-speed configuration.

Table 5-3 Configuration Example of a Complex Composite High-Speed USB Device

Device Driver Guide

There are many USB device controllers available on the market and each requires a driver to work with μ C/USB-Device. The amount of code necessary to port a specific device to μ C/USB-Device greatly depends on the device's complexity.

If not already available, a driver can be developed, as described in this chapter. However, it is recommended to modify an already existing device driver with the new device's specific code following the Micrium coding convention for consistency. It is also possible to adapt drivers written for other USB device stacks, especially if the driver is short and it is a matter of simply copying data to and from the device.

6-1 DEVICE DRIVER ARCHITECTURE

This section describes the hardware (device) driver architecture for μ C/USB-Device, including:

- Device Driver API Definition(s)
- Device Configuration
- Memory Allocation
- CPU and Board Support

Micrium provides sample configuration code free of charge; however, the sample code will likely require modification depending on the combination of processor, evaluation board, and USB device controller(s).

6-2 DEVICE DRIVER MODEL

No particular memory interface is required by μ C/USB-Device's driver model. Therefore, the USB device controller may use the assistance of a Direct Memory Access (DMA) controller to transfer data or handle the data transfers directly.

6-3 DEVICE DRIVER API

All device drivers must declare an instance of the appropriate device driver API structure as a global variable within the source code. The API structure is an ordered list of function pointers utilized by μ C/USB-Device when device hardware services are required.

A sample device driver API structure is shown below.

```
const USBD_DRV_API USBD_DrvAPI_<controller> = { USBD_DrvInit,           (1)
                                                USBD_DrvStart,           (2)
                                                USBD_DrvStop,           (3)
                                                USBD_DrvAddrSet,        (4)
                                                USBD_DrvAddrEn,        (5)
                                                USBD_DrvCfgSet,        (6)
                                                USBD_DrvCfgClr,        (7)
                                                USBD_DrvGetFrameNbr,   (8)
                                                USBD_DrvEP_Open,       (9)
                                                USBD_DrvEP_Close,      (10)
                                                USBD_DrvEP_RxStart,    (11)
                                                USBD_DrvEP_Rx,         (12)
                                                USBD_DrvEP_RxZLP,      (13)
                                                USBD_DrvEP_Tx,         (14)
                                                USBD_DrvEP_TxStart,    (15)
                                                USBD_DrvEP_TxZLP,      (16)
                                                USBD_DrvEP_Abort,      (17)
                                                USBD_DrvEP_Stall,      (18)
                                                USBD_DrvISR_Handler   (19)
};
```

Listing 6-1 Device Driver Interface API

Note: It is the device driver developers' responsibility to ensure that all of the functions listed within the API are properly implemented and that the order of the functions within the API structure is correct. The different function pointers are:

L6-1(1)	Device initialization/add
L6-1(2)	Device start
L6-1(3)	Device stop
L6-1(4)	Assign device address
L6-1(5)	Enable device address
L6-1(6)	Set device configuration
L6-1(7)	Clear device configuration
L6-1(8)	Retrieve frame number
L6-1(9)	Open device endpoint
L6-1(10)	Close device endpoint
L6-1(11)	Configure device endpoint to receive data
L6-1(12)	Receive from device endpoint
L6-1(13)	Receive zero-length packet from device endpoint
L6-1(14)	Configure device endpoint to transmit data
L6-1(15)	Transmit to device endpoint
L6-1(16)	Transmit zero-length packet to device endpoint
L6-1(17)	Abort device endpoint transfer
L6-1(18)	Stall device endpoint
L6-1(19)	Device interrupt service routine (ISR) handler

The details of each device driver API function are described in Appendix B, “Device Controller Driver API Reference” on page 323.

Note: μ C/USB-Device device driver API function names may not be unique. Name clashes between device drivers are avoided by never globally prototyping device driver functions and ensuring that all references to functions within the driver are obtained by pointers within the API structure. The developer may arbitrarily name the functions within the source file so long as the API structure is properly declared. The user application should never need to call API functions. Unless special care is taken, calling device driver functions may lead to unpredictable results due to reentrancy.

When writing your own device driver, you can assume that each driver API function accepts a pointer to a structure of the type `USBD_DRV` as one of its parameters. Through this structure, you will be able to access the following fields:

```
typedef struct usbd_drv  USBD_DRV;

typedef  usb_drv {
    CPU_INT08U           DevNbr;                (1)
    USBD_DRV_API        *API_Ptr;             (2)
    USBD_DRV_CFG        *CfgPtr;             (3)
    void                *DataPtr;            (4)
    USBD_DRV_BSP_API    *BSP_API_Ptr;        (5)
};
```

Listing 6-2 **USB Device Driver Data Type**

- L6-2(1) Unique index to identify device.
- L6-2(2) Pointer to USB device controller driver API.
- L6-2(3) Pointer to USB device controller driver configuration.
- L6-2(4) Pointer to USB device controller driver specific data.
- L6-2(5) Pointer to USB device controller BSP.

6-4 INTERRUPT HANDLING

Interrupt handling is accomplished using the following multi-level scheme.

- 1 Processor level kernel-aware interrupt handler
- 2 Device driver interrupt handler

During initialization, the device driver registers all necessary interrupt sources with the BSP interrupt management code. You can also accomplish this by plugging an interrupt vector table during compile time. Once the global interrupt vector sources are configured and an interrupt occurs, the system will call the first-level interrupt handler. The first-level interrupt handler is responsible for performing all kernel required steps prior to calling the USB device driver interrupt handler: `USBD_DrvISR_Handler()`. Depending on the platform architecture (that is the way the kernel handles interrupts) and the USB device controller interrupt vectors, the device driver interrupt handler implementation may follow the models below.

6-4-1 SINGLE USB ISR VECTOR WITH ISR HANDLER ARGUMENT

If the platform architecture allows parameters to be passed to ISR handlers and the USB device controller has a single interrupt vector for the USB device, the first-level interrupt handler may be defined as:

PROTOTYPE

```
void USBD_BSP_<controller>_IntHandler (void *p_arg);
```

ARGUMENTS

p_arg Pointer to USB device driver structure that must be typecast to a pointer to `USBD_DRV`.

6-4-2 SINGLE USB ISR VECTOR

If the platform architecture does not allow parameters to be passed to ISR handlers and the USB device controller has a single interrupt vector for the USB device, the first-level interrupt handler may be defined as:

PROTOTYPE

```
void USBD_BSP_<controller>_IntHandler (void);
```

ARGUMENTS

None.

NOTES / WARNINGS

In this configuration, the pointer to the USB device driver structure must be stored globally in the driver. Since the pointer to the USB device structure is never modified, the BSP initialization function, `USBD_BSP_Init()`, can save its address for later use.

6-4-3 MULTIPLE USB ISR VECTORS WITH ISR HANDLER ARGUMENTS

If the platform architecture allows parameters to be passed to ISR handlers and the USB device controller has multiple interrupt vectors for the USB device (e.g., USB events, DMA transfers), the first-level interrupt handler may need to be split into multiple sub-handlers. Each sub-handler would be responsible for managing the status reported to the different vectors. For example, the first-level interrupt handlers for a USB device controller that redirects USB events to one interrupt vector and the status of DMA transfers to a second interrupt vector may be defined as:

PROTOTYPE

```
void USBD_BSP_<controller>_EventIntHandler (void *p_arg);  
void USBD_BSP_<controller>_DMAIntHandler (void *p_arg);
```

ARGUMENTS

`p_arg` Pointer to USB device driver structure that must be typecast to a pointer to `USBDRV`.

6-4-4 MULTIPLE USB ISR VECTORS

If the platform architecture does not allow parameters to be passed to ISR handlers and the USB device controller has multiple interrupt vectors for the USB device (e.g., USB events, DMA transfers), the first-level interrupt handler may need to be split into multiple sub-handlers. Each sub-handler would be responsible for managing the status reported to the different vectors. For example, the first-level interrupt handlers for a USB device controller that redirects USB events to one interrupt vector and the status of DMA transfers to a second interrupt vector may be defined as:

PROTOTYPE

```
void USBD_BSP_<controller>_EventIntHandler (void);
void USBD_BSP_<controller>_DMAIntHandler (void);
```

ARGUMENTS

None.

NOTES / WARNINGS

In this configuration, the pointer to the USB device driver structure must be stored globally in the driver. Since the pointer to the USB device structure is never modified, the BSP initialization function, `USBD_BSP_Init()`, can save its address for later use.

6-4-5 USBD_DrvISR_HANDLER()

The device driver interrupt handler must notify the USB device stack of various status changes. Table 6-1 shows each type of status change and the corresponding notification function.

Connect Event	<code>USBD_EventConn()</code>
Disconnect Event	<code>USBD_EventDisconn()</code>
Reset Event	<code>USBD_EventReset()</code>
Suspend Event	<code>USBD_EventSuspend()</code>
Resume Event	<code>USBD_EventResume()</code>
High-Speed Handshake Event	<code>USBD_EventHS()</code>

Setup Packet	USBD_EventSetup()
Receive Packet Completed	USBD_EP_RxCmpl()
Transmit Packet Completed	USBD_EP_TxCmpl()

Table 6-1 Status Notification API

Each status notification API queues the event type to be processed by the USB stack's event processing task. Upon reception of an USB event, the interrupt service routine may perform some operations associated to the event before notifying the stack. For example, the USB device controller driver must perform the proper actions for the bus reset when an interrupt request for that event is triggered. Additionally, it must also notify the USB device stack about the bus reset event by invoking the proper status notification API. In general, the device driver interrupt handler must perform the following functions:

- 1 Determine which type of interrupt event occurred by reading an interrupt status register.
- 2 If a receive event has occurred, the driver must post the successful completion or the error status to the USB device stack by calling `USBD_EP_RxCmpl()` for each transfer received.
- 3 If a transmit complete event has occurred, the driver must post the successful completion or the error status to the USB device stack by calling `USBD_EP_TxCmpl()` for each transfer transmitted.
- 4 If a setup packet event has occurred, the driver must post the setup packet data in little-endian format to the USB device stack by calling `USBD_EventSetup()`.
- 5 All other events must be posted to the USB device stack by a call to their corresponding status notification API from Table 1. This allows the USB device stack to broadcast these event notifications to the classes.
- 6 Clear local interrupt flags.

6-5 DEVICE CONFIGURATION

The USB device characteristics must be shared with the USB device stack through configuration parameters. All of these parameters are provided through two global structures of type `USBD_DRV_CFG` and `USBD_DEV_CFG`. These structures are declared in the file `usbd_dev_cfg.h`, and defined in the file `usbd_dev_cfg.c` (refer to section 2-4-2 “Copying and Modifying Template Files” on page 33 for an example of initialization of these structures). These files are distributed as templates, and you should modify them to have the proper configuration for your USB device controller. The fields of the following structure are the parameters needed to configure the USB device controller driver:

```
typedef const struct usb_drv_cfg {
    CPU_ADDR      BaseAddr;           (1)
    CPU_ADDR,     MemAddr;           (2)
    CPU_ADDR,     MemSize;           (3)
    USBD_DEV_SPD, Spd;               (4)
    USBD_DRV_EP_INFO *EP_InfoTbl;   (5)
} USBD_DRV_CFG;
```

Listing 6-3 USB Device Controller Driver Configuration Structure

- L6-3(1) Base address of the USB device controller hardware registers.
- L6-3(2) Base address of the USB device controller dedicated memory.
- L6-3(3) Size of the USB device controller dedicated memory.
- L6-3(4) Speed of the USB device controller. Can be set to either `USBD_DEV_SPD_LOW`, `USBD_DEV_SPD_FULL` or `USBD_DEV_SPD_HIGH`.
- L6-3(5) USB device controller endpoint information table (see section 6-5-1 “Endpoint Information Table” on page 86).

The fields of the following structure are the parameters needed to configure the USB device:

```

typedef const struct usb_dev_cfg {
    CPU_INT16U  VendorID;           (1)
    CPU_INT16U  ProductID;         (2)
    CPU_INT16U  DeviceBCD;         (3)
    const CPU_CHAR *ManufacturerStrPtr; (4)
    const CPU_CHAR *ProductStrPtr;  (5)
    const CPU_CHAR *SerialNbrStrPtr; (6)
    CPU_INT16U  LangID;           (7)
} USBDEVCFG;

```

Listing 6-4 USB Device Configuration Structure

- L6-4(1) Vendor ID.
- L6-4(2) Product ID.
- L6-4(3) Device release number.
- L6-4(4) Pointer to manufacturer string.
- L6-4(5) Pointer to product string.
- L6-4(6) Pointer to serial number ID.
- L6-4(7) Language ID.

6-5-1 ENDPOINT INFORMATION TABLE

The endpoint information table provides the hardware endpoint characteristics to the USB device stack. When an endpoint is opened, the USB device stack's core iterates through the endpoint information table entries until the endpoint type and direction match the requested endpoint characteristics. The matching entry provides the physical endpoint number and maximum packet size information to the USB device stack. The entries on the endpoint information table are organized as follows:

```

typedef const struct usbd_drv_ep_info {
    CPU_INT08U  Attrib;                (1)
    CPU_INT08U  Nbr;                  (2)
    CPU_INT16U  MaxPktSize;          (3)
} USBD_DRV_EP_INFO;

```

Listing 6-5 Endpoint Information Table Entry

- L6-5(1) The endpoint **Attrib** is a combination of the endpoint type **USB_EP_INFO_TYPE** and endpoint direction **USB_EP_INFO_DIR** attributes. The endpoint type can be defined as: **USB_EP_INFO_TYPE_CTRL**, **USB_EP_INFO_TYPE_INTR**, **USB_EP_INFO_TYPE_BULK**, or **USB_EP_INFO_TYPE_ISOC**. The endpoint direction can be defined as either **USB_EP_INFO_DIR_IN** or **USB_EP_INFO_DIR_OUT**.
- L6-5(2) The endpoint **Nbr** is the physical endpoint number used by the USB device controller.
- L6-5(3) The endpoint **MaxPktSize** defines the maximum packet size supported by hardware. The maximum packet size used by the USB device stack is validated to follow the USB standard guidelines.

An example of an endpoint information table for a high-speed capable device is provided below.

```

const USBD_DRV_EP_INFO USBD_DrvEP_InfoTbl_<controller>[] = {
    {USB_EP_INFO_TYPE_CTRL | USB_EP_INFO_DIR_OUT, 0u, 64u},
    {USB_EP_INFO_TYPE_CTRL | USB_EP_INFO_DIR_IN, 0u, 64u},
    {USB_EP_INFO_TYPE_BULK | USB_EP_INFO_TYPE_INTR | USB_EP_INFO_DIR_OUT, 1u, 1024u},
    {USB_EP_INFO_TYPE_BULK | USB_EP_INFO_TYPE_INTR | USB_EP_INFO_DIR_IN, 1u, 1024u},
    {DEF_BIT_NONE, 0u, 0u} (1)
};

```

Listing 6-6 Example of Endpoint Information Table Configuration

- L6-6(1) The last entry on the endpoint information table must be an empty entry to allow the USB device stack to determine the end of the table.

6-6 MEMORY ALLOCATION

Memory allocation in the driver can be simplified by the use of memory allocation functions available from $\mu\text{C}/\text{LIB}$. $\mu\text{C}/\text{LIB}$'s memory allocation functions provide allocation of memory from dedicated memory space (e.g., USB RAM) or general purpose heap. The driver may use the pool functionality offered by $\mu\text{C}/\text{LIB}$. Memory pools use fixed-sized blocks that can be dynamically allocated and freed during application execution. Memory pools may be convenient to manage objects needed by the driver. The objects could be for instance data structures mandatory for DMA operations. For more information on using $\mu\text{C}/\text{LIB}$ memory allocation functions, consult the $\mu\text{C}/\text{LIB}$ documentation.

6-7 CPU AND BOARD SUPPORT

The USB device stack supports big-endian and little-endian CPU architectures. The setup packet received as part of a control transfer must provide the content of the setup packet in little-endian format to the stack. Therefore, if the USB device controller provides the content in big-endian format, device drivers must swap the endianness of the setup packet's content.

In order for device drivers to be platform-independent, it is necessary to provide a layer of code that abstracts details such as clocks, interrupt controllers, general-purpose input/output (GPIO) pins, and other hardware modules configuration. With this board support package (BSP) code layer, it is possible for the majority of the USB device stack to be independent of any specific hardware, and for device drivers to be reused on different architectures and bus configurations without the need to modify stack or driver source code. These procedures are also referred as the USB BSP for a particular development board.

A sample device BSP interface API structure is shown below.

```
const USBDRV_BSP_API USBDRV_BSP_<controller> = { USBDRV_BSP_Init,           (1)
                                                  USBDRV_BSP_Conn,         (2)
                                                  USBDRV_BSP_Disconn       (3)
};
```

Listing 6-7 Device BSP Interface API

- L6-7(1) Device BSP initialization function pointer
- L6-7(2) Device BSP connect function pointer
- L6-7(3) Device BSP disconnect function pointer

The details of each device BSP API function are described in section B-2 “Device Driver BSP Functions” on page 350.

6-8 USB DEVICE DRIVER FUNCTIONAL MODEL

The USB device controller can operate in distinct modes while transferring data. This section describes the common sequence of operations for the receive and transmit API functions in the device driver, highlighting potential differences when the controller is operating on FIFO or DMA mode. While there are some controllers that are strictly FIFO based or DMA based, there are controllers that can operate in both modes depending on hardware characteristics. For this type of controller, the device driver will employ the appropriate sequence of operations depending, for example, on the endpoint type.

6-8-1 DEVICE SYNCHRONOUS RECEIVE

The device synchronous receive operation is initiated by the calls: `USB_DrvEP_RxStart()`, `USB_DrvEP_Rx()`, and `USB_EP_RxCmpl()`. Figure 6-1 shows an overview of the device synchronous receive operation.



Figure 6-1 Device Synchronous Receive Diagram

F6-1(1) The upper layer API's, `USBD_BulkRx()`, `USBD_CtrlRx()`, and `USBD_IntrRx()`, call `USBD_EP_Rx()`, where `USBD_DrvEP_RxStart()` is invoked.

On DMA-based controllers, this device driver API is responsible for queuing a receive transfer. The queued receive transfer does not need to satisfy the whole requested transfer length at once. If multiple transfers are queued only the last queued transfer must be signaled to the USB device stack. This is required since the USB device stack iterates through the receive process until all requested data or a short packet has been received.

On FIFO-based controllers, this device driver API is responsible for enabling data to be received into the endpoint FIFO, including any related ISR's.

F6-1(2) While data is being received, the device synchronous receive operation waits on the device receive signal.

F6-1(3) The USB device controller triggers an interrupt request when it is finished receiving the data. This invokes the USB device driver interrupt service routine (ISR) handler, directly or indirectly, depending on the architecture.

F6-1(4) Inside the USB device driver ISR handler, the type of interrupt request is determined to be a receive interrupt. `USBD_EP_RxCmpl()` is called to unblock the device receive signal.

F6-1(5) The device receive operation reaches the `USBD_EP_Rx()`, which internally calls `USBD_DrvEP_Rx()`.

On DMA-based controllers, this device driver API is responsible for de-queuing the completed receive transfer and returning the amount of data received. In case the DMA-based controller requires the buffered data to be placed in a dedicated USB memory region, the buffered data must be transferred into the application buffer area.

On FIFO-based controllers, this device driver API is responsible for reading the amount of data received by copying it into the application buffer area and returning the data back to its caller.

F6-1(6) The device receive operation iterates through the process until the amount of data received matches the amount requested, or a short packet is received.

6-8-2 DEVICE ASYNCHRONOUS RECEIVE

The device asynchronous receive operation is initiated by the calls: `USB_DrvEP_RxStart()` and `USB_EP_Rx()`. Figure 6-2 shows an overview of the device asynchronous receive operation.



Figure 6-2 Device Asynchronous Receive Diagram

F6-2(1) The upper layer API's, `USB_BulkRxAsync()` and `USB_IntrRxAsync()`, call `USB_EP_Rx()` passing a receive complete callback function as an argument. In `USB_EP_Rx()`, the `USB_DrvEP_RxStart()` function is invoked in the same way as for the synchronous operation.

On DMA-based controllers, this device driver API is responsible for queuing a receive transfer. The queued receive transfer does not need to satisfy the whole requested transfer length at once. If multiple transfers are queued only the last queued transfer must be signaled to the USB device stack. This is required since the USB device stack iterates through the receive process until all requested data or a short packet has been received.

On FIFO-based controllers, this device driver API is responsible for enabling data to be received into the endpoint FIFO, including any related ISRs.

The call to `USB_EP_Rx()` returns immediately to the application (without blocking) while data is being received.

F6-2(2) The USB device controller triggers an interrupt request when it is finished receiving the data. This invokes the USB device driver interrupt service routine (ISR) handler, directly or indirectly, depending on the architecture.

F6-2(3) Inside the USB device driver ISR handler, the type of interrupt request is determined to be a receive interrupt. `USBD_EP_RxCmpl()` is called to queue the endpoint that had its transfer completed.

F6-2(4) The core task de-queues the endpoint that completed a transfer and invokes `USBD_EP_Process()`, which internally calls `USBD_DrvEP_Rx()`.

On DMA-based controllers, this device driver API is responsible for de-queuing the completed receive transfer and returning the amount of data received. In case the DMA-based controller requires the buffered data to be placed in a dedicated USB memory region, the buffered data must be transferred into the application buffer area.

On FIFO-based controllers, this device driver API is responsible for reading the amount of data received by copying it into the application buffer area and returning the data back to its caller.

F6-2(5) If the overall amount of data received is less than the amount requested and the current transfer is not a short packet, `USBD_DrvEP_RxStart()` is called to request the remaining data.

On DMA-based controllers, this device driver API is responsible for queuing a receive transfer. The queued receive transfer does not need to satisfy the whole requested transfer length at once. If multiple transfers are queued only the last queued transfer must be signaled to the USB device stack. This is required since the USB device stack iterates through the receive process until all requested data or a short packet has been received.

On FIFO-based controllers, this device driver API is responsible for enabling data to be received into the endpoint FIFO, including any related ISRs.

F6-2(6) The receive operation finishes when the amount of data received matches the amount requested, or a short packet is received. The receive complete callback is invoked to notify the application about the completion of the process.

6-8-3 DEVICE SYNCHRONOUS TRANSMIT

The device synchronous transmit operation is initiated by the calls: `USBD_BulkTx()`, `USBD_CtrlTx()`, and `USBD_IntrTx()`. Figure 6-3 shows an overview of the device synchronous transmit operation.



Figure 6-3 Device Synchronous Transmit Diagram

F6-3(1) The upper layer API's, `USBD_BulkTx()`, `USBD_CtrlTx()`, and `USBD_IntrTx()`, call `USBD_EP_Tx()`, where `USBD_DrvEP_Tx()` is invoked.

On DMA-based controllers, this device driver API is responsible for preparing the transmit transfer/descriptor and returning the amount of data to transmit. In case the DMA-based controller requires the buffered data to be placed in a dedicated USB memory region, the contents of the application buffer area must be transferred into the dedicated memory region.

On FIFO-based controllers, this device driver API is responsible for writing the amount of data to transfer into the FIFO and returning the amount of data to transmit.

F6-3(2) The `USB_DrvEP_TxStart()` API starts the transmit process.

On DMA-based controllers, this device driver API is responsible for queuing the DMA transmit descriptor and enabling DMA transmit complete ISR's.

On FIFO-based controllers, this device driver API is responsible for enabling transmit complete ISR's.

F6-3(3) While data is being transmitted, the device synchronous transmit operation waits on the device transmit signal.

F6-3(4) The USB device controller triggers an interrupt request when it is finished transmitting the data. This invokes the USB device driver interrupt service routine (ISR) handler, directly or indirectly, depending on the architecture.

F6-3(5) Inside the USB device driver ISR handler, the type of interrupt request is determined as a transmit interrupt. `USB_EP_TxCmpl()` is called to unblock the device transmit signal.

On DMA-based controllers, the transmit transfer is de-queued from a list of completed transfers.

F6-3(6) The device transmit operation iterates through the process until the amount of data transmitted matches the requested amount.

6-8-4 DEVICE ASYNCHRONOUS TRANSMIT

The device asynchronous transmit operation is initiated by the calls: `USBD_BulkTxAsync()` and `USBD_IntrTxAsync()`. Figure 6-4 shows an overview of the device asynchronous transmit operation

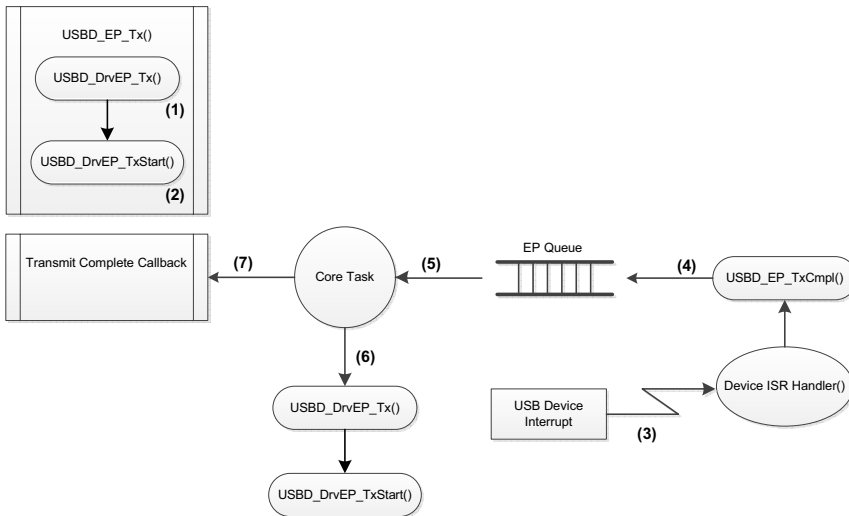

Figure 6-4 Device Asynchronous Transmit Diagram

F6-4(1) The upper layer API's, `USBD_BulkTxAsync()` and `USBD_IntrTxAsync()`, call `USBD_EP_Tx()` passing a transmit complete callback function as an argument. In `USBD_EP_Tx()`, the `USBD_DrvEP_Tx()` function is invoked in the same way as for the synchronous operation.

On DMA-based controllers, this device driver API is responsible for preparing the transmit transfer/descriptor and returning the amount of data to transmit. In case the DMA-based controller requires the buffered data to be placed in a dedicated USB memory region, the contents of the application buffer area must be transferred into the dedicated memory region.

On FIFO-based controllers, this device driver API is responsible for writing the amount of data to transfer into the FIFO and returning the amount of data to transmit.

F6-4(2) The `USBD_DrvEP_TxStart()` API starts the transmit process.

On DMA-based controllers, this device driver API is responsible for queuing the DMA transmit descriptor and enabling DMA transmit complete ISR's.

On FIFO-based controllers, this device driver API is responsible for enabling transmit complete ISR's.

The call to `USBD_EP_Tx()` returns immediately to the application (without blocking) while data is being transmitted.

F6-4(3) The USB device controller triggers an interrupt request when it is finished transmitting the data. This invokes the USB device driver interrupt service routine (ISR) handler, directly or indirectly, depending on the architecture.

F6-4(4) Inside the USB device driver ISR handler, the type of interrupt request is determined as a transmit interrupt. `USBD_EP_TxCmpl()` is called to queue the endpoint that had its transfer completed.

On DMA-based controllers, the transmit transfer is de-queued from the list of completed transfers.

F6-4(5) The core task de-queues the endpoint that completed a transfer.

F6-4(6) If the overall amount of data transmitted is less than the amount requested, `USBD_DrvEP_Tx()` and `USBD_DrvEP_TxStart()` are called to transmit the remaining amount of data.

F6-4(7) The device transmit operation finishes when the amount of data transmitted matches the amount requested. The transmit complete callback is invoked to notify the application about the completion of the process.

6-8-5 DEVICE SET ADDRESS

The device set address operation is performed by the setup transfer handler when a **SET_ADDRESS** request is received. Figure 6-5 shows an overview of the device set address operation.



Figure 6-5 **Device Set Address Diagram**

- F6-5(1) Once the arguments of the setup request are validated, `USB_DrvAddrSet()` is called to inform the device driver layer of the new address. For controllers that have hardware assistance in setting the device address after the status stage, this device driver API is used to configure the device address and enable the transition after the status stage. For controllers that activate the device address as soon as configured, this device driver API should not perform any action.
- F6-5(2) The setup request status stage is transmitted to acknowledge the address change.
- F6-5(3) After the status stage, the `USB_DrvAddrEn()` is called to inform the device driver layer to enable the new device address. For controllers that activate the device address as soon as configured, this device driver API is responsible for setting and enabling the new device address. For controllers that have hardware assistance in setting the device address after the status stage, this device driver API should not perform any action, since `USB_DrvAddrSet()` has already taken care of setting the new device.

USB Classes

The USB classes available for the μ C/USB-Device stack have some common characteristics. This chapter explains these characteristics and the interactions with the core layer allowing you to better understand the operation of classes.

7-1 CLASS INSTANCE CONCEPT

The USB classes available with the μ C/USB-Device stack implement the concept of class instances. A class instance represents one function within a device. The function can be described by one interface or by a group of interfaces and belongs to a certain class.

Each USB class implementation has some configuration and functions in common based on the concept of class instance. The common configuration and functions are presented in Table 7-1. In the column heading 'Constants or Function', **XXXX** below can be replaced by the name of the class: CDC, HID, MSC, PHDC or VENDOR (Vendor for function names).

Constant or function	Description
USBD_XXXX_CFG_MAX_NBR_DEV	Configures the maximum number of class instances.
USBD_XXXX_CFG_MAX_NBR_CFG	Configures the maximum number of configurations per device. During the class initialization, a created class instance will be added to one or more configurations.
USBD_XXXX_Add()	Creates a new class instance.
USBD_XXXX_CfgAdd()	Adds an existing class instance to the specified device configuration.

Table 7-1 Constants and Functions Related to the Concept of Multiple Class Instances

In terms of code implementation, the class will declare a local global table that contains a class control structure. The size of the table is determined by the constant `USBD_XXXX_CFG_MAX_NBR_DEV`. This class control structure is associated with one class

instance and will contain certain information to manage the class instance. See section 7-2 “Class Instance Structures” on page 108 for more details about this class control structure.

The following illustrations present several case scenarios. Each illustration is followed by a code listing showing the code corresponding to the case scenario. Figure 7-1 represents a typical USB device. The device is Full-Speed (FS) and contains one single configuration. The function of the device is described by one interface composed of a pair of endpoints for the data communication. One class instance is created and it will allow you to manage the entire interface with its associated endpoint.



Figure 7-1 **Multiple Class Instances - FS Device (1 Configuration with 1 Interface)**

The code corresponding to Figure 7-1 is shown in Listing 7-1.

```

USB_D_ERR    err;
CPU_INT08U   class_0;

USB_D_XXXX_Init(&err);                                (1)
if (err != USB_D_ERR_NONE) {
    /* $$$ Handle the error. */
}

class_0 = USB_D_XXXX_Add(&err);                        (2)
if (err != USB_D_ERR_NONE) {
    /* $$$ Handle the error. */
}

USB_D_XXXX_CfgAdd(class_0, dev_nbr, cfg_0, &err);     (3)
if (err != USB_D_ERR_NONE) {
    /* $$$ Handle the error. */
}

```

Listing 7-1 Multiple Class Instances - FS Device (1 Configuration with 1 Interface) - Code

- L7-1(1) Initialize the class. Any internal variables, structures, and class Real-Time Operating System (RTOS) port will be initialized.
- L7-1(2) Create the class instance, `class_0`. The function `USB_D_XXXX_Add()` allocates a class control structure associated to `class_0`. Depending on the class, besides the parameter for an error code, `USB_D_XXXX_Add()` may have additional parameters representing class-specific information stored in the class control structure.
- L7-1(3) Add the class instance, `class_0`, to the specified configuration number, `cfg_0`. `USB_D_XXXX_CfgAdd()` will create the interface 0 and its associated endpoints IN and OUT. Hence, the class instance encompasses the interface 0 and its endpoints. Any communication done on the interface 0 will use the class instance number, `class_0`.

Figure 7-2 represents an example of a high-speed capable device. The device can support High-Speed (HS) and Full-Speed (FS). The device will contain two configurations: one valid if the device operates at full-speed and another if it operates at high-speed. In each configuration, interface 0 is the same but its associated endpoints are different. The difference will be the endpoint maximum packet size which varies according to the speed.

If a high-speed host enumerates this device, by default, the device will work in high-speed mode and thus the high-speed configuration will be active. The host can learn about the full-speed capabilities by getting a *Device_Qualifier* descriptor followed by an *Other_Speed_Configuration* descriptor. These two descriptors describe a configuration of a high-speed capable device if it were operating at its other possible speed (refer to Universal Serial Bus 2.0 Specification revision 2.0, section 9.6, for more details about these descriptors). In our example, the host may want to reset and enumerate the device again in full-speed mode. In this case, the full-speed configuration is active. Whatever the active configuration, the same class instance is used. Indeed, the same class instance can be added to different configurations. A class instance cannot be added several times to the same configuration.



Figure 7-2 Multiple Class Instances - HS/FS Device (2 Configurations and 1 Single Interface)

The code corresponding to Figure 7-2 is shown in Listing 7-2.

```

USB_D_ERR    err;
CPU_INT08U   class_0;

USB_D_XXXX_Init(&err);                                (1)
if (err != USB_D_ERR_NONE) {
    /* $$$ Handle the error. */
}

class_0 = USB_D_XXXX_Add(&err);                        (2)
if (err != USB_D_ERR_NONE) {
    /* $$$ Handle the error. */
}

USB_D_XXXX_CfgAdd(class_0, dev_nbr, cfg_0_fs, &err);  (3)
if (err != USB_D_ERR_NONE) {
    /* $$$ Handle the error. */
}

USB_D_XXXX_CfgAdd(class_0, dev_nbr, cfg_0_hs, &err);  (4)
if (err != USB_D_ERR_NONE) {
    /* $$$ Handle the error. */
}

```

Listing 7-2 **Multiple Class Instances - HS/FS Device (2 Configurations and 1 Single Interface) - Code**

- L7-2(1) Initialize the class. Any internal variables, structures, and class RTOS port will be initialized.
- L7-2(2) Create the class instance, `class_0`. The function `USB_D_XXXX_Add()` allocates a class control structure associated to `class_0`. Depending on the class, besides the parameter for an error code, `USB_D_XXXX_Add()` may have additional parameters representing class-specific information stored in the class control structure.
- L7-2(3) Add the class instance, `class_0`, to the full-speed configuration, `cfg_0_fs`. `USB_D_XXXX_CfgAdd()` will create the interface 0 and its associated endpoints IN and OUT. If the full-speed configuration is active, any communication done on the interface 0 will use the class instance number, `class_0`.
- L7-2(4) Add the class instance, `class_0`, to the high-speed configuration, `cfg_0_hs`.

In the case of the high-speed capable device presented in Figure 7-2, in order to enable the use of *Device_Qualifier* and *Other_Speed_Configuration* descriptors, the function `USBD_CfgOtherSpeed()` should be called during the μ C/USB-Device initialization. Listing 2-5 presents the function `App_USBD_Init()` defined in `app_usbd.c`. This function shows an example of the μ C/USB-Device initialization sequence. `USBD_CfgOtherSpeed()` should be called after the creation of a high-speed and a full-speed configurations with `USBD_CfgAdd()`. Listing 7-3 below shows the use `USBD_CfgOtherSpeed()` based on Listing 2-5. Error handling is omitted for clarity.

```
CCPU_BOOLEAN App_USBD_Init (void)
{
    CPU_INT08U  dev_nbr;
    CPU_INT08U  cfg_0_fs;
    CPU_INT08U  cfg_0_hs;
    USBD_ERR    err;

    ... (1)

    if (USBD_DrvCfg<controller>.Spd == USBD_DEV_SPD_HIGH) {

        cfg_0_hs = USBD_CfgAdd( dev_nbr, (2)
                               USBD_DEV_ATTRIB_SELF_POWERED,
                               100u,
                               USBD_DEV_SPD_HIGH,
                               "HS configuration",
                               &err);

    }
    cfg_0_fs = USBD_CfgAdd( dev_nbr, (3)
                           USBD_DEV_ATTRIB_SELF_POWERED,
                           100u,
                           USBD_DEV_SPD_FULL,
                           "FS configuration",
                           &err);

    USBD_CfgOtherSpeed(dev_nbr, (4)
                       cfg_0_hs,
                       cfg_0_fs,
                       &err);

    return (DEF_OK);
}
```

Listing 7-3 Use of `USBD_CfgOtherSpeed()`

- L7-3(1) Refer to Listing 2-5 for the beginning of the initialization.
- L7-3(2) Create the high-speed configuration, `cfg_0_hs`, to your high-speed capable device.
- L7-3(3) Create the full-speed configuration, `cfg_0_fs`, to your high-speed capable device.
- L7-3(4) Associate the high-speed configuration `cfg_0_hs` with its other-speed counterpart, `cfg_0_fs`.

Figure 7-3 represents a more complex example. A full-speed device is composed of two configurations. The device has two functions which belong to the same class. Each function is described by two interfaces. Each interface has a pair of bidirectional endpoints. In this example, two class instances are created. Each class instance is associated with a group of interfaces as opposed to Figure 7-1 and Figure 7-2 where the class instance was associated to a single interface.



Figure 7-3 **Multiple Class Instances - FS Device (2 Configurations and Multiple Interfaces)**

The code corresponding to Figure 7-3 is shown in Listing 7-4. The error handling is omitted for clarity.

```

USB_D_ERR    err;
CPU_INT08U   class_0;
CPU_INT08U   class_1;

USB_D_XXXX_Init(&err);                                     (1)

class_0 = USB_D_XXXX_Add(&err);                           (2)
class_1 = USB_D_XXXX_Add(&err);                           (3)

USB_D_XXXX_CfgAdd(class_0, dev_nbr, cfg_0, &err);        (4)
USB_D_XXXX_CfgAdd(class_1, dev_nbr, cfg_0, &err);        (5)

USB_D_XXXX_CfgAdd(class_0, dev_nbr, cfg_1, &err);        (6)
USB_D_XXXX_CfgAdd(class_1, dev_nbr, cfg_1, &err);        (6)

```

Listing 7-4 Multiple Class Instances - FS Device (2 Configurations and Multiple Interfaces) - Code

- L7-4(1) Initialize the class. Any internal variables, structures, and class RTOS port will be initialized.
- L7-4(2) Create the class instance, `class_0`. The function `USB_D_XXXX_Add()` allocates a class control structure associated to `class_0`.
- L7-4(3) Create the class instance, `class_1`. The function `USB_D_XXXX_Add()` allocates another class control structure associated to `class_1`.
- L7-4(4) Add the class instance, `class_0`, to the configuration, `cfg_0`. `USB_D_XXXX_CfgAdd()` will create the interface 0, interface 1, alternate interfaces, and the associated endpoints IN and OUT. The class instance number, `class_0`, will be used for any data communication on interface 0 or interface 1.
- L7-4(5) Add the class instance, `class_1`, to the configuration, `cfg_0`. `USB_D_XXXX_CfgAdd()` will create the interface 2, interface 3 and their associated endpoints IN and OUT. The class instance number, `class_1`, will be used for any data communication on interface 2 or interface 3.
- L7-4(6) Add the same class instances, `class_0` and `class_1`, to the other configuration, `cfg_1`.

You can refer to section 5-4 “Configuration Examples” on page 71 for some configuration examples showing multiple class instances applied to composite devices. Composite devices use at least two different classes provided by the μ C/USB-Device stack. The section 5-4-2 “Composite High-Speed USB device” on page 73 gives a concrete example based on Figure 7-2. See section 5-4-3 “Complex Composite High-Speed USB device” on page 74 for a hybrid example that corresponds to Figure 7-2 and Figure 7-3.

7-2 CLASS INSTANCE STRUCTURES

When a class instance is created, a control structure is allocated and associated to a specific class instance. The class uses this control structure for its internal operations. All the Micrium USB classes define a class control structure data type. Listing 7-5 shows the structure declaration with the common fields.

```
struct usbd_xxxx_ctrl {
    CPU_INT08U    DevNbr;           (1)
    CPU_INT08U    ClassNbr;        (2)
    USBD_XXXX_STATE State;         (3)
    USBD_XXXX_COMM *CommPtr;       (4)
    ...           (5)
};
```

Listing 7-5 **Class Instance Control Structure**

- L7-5(1) The device number to which the class instance is associated with.
- L7-5(2) The class instance number.
- L7-5(3) The class instance state.
- L7-5(4) A pointer to a class instance communication structure. This structure holds information regarding the interface’s endpoints used for data communication. Listing 7-6 presents the communication structure.
- L7-5(5) Class-specific fields.

During the communication phase, the class communication structure is used by the class for data transfers on the endpoints. It allows you to route the transfer to the proper endpoint within the interface. There will be one class communication structure per configuration to which the class instance has been added. Listing 7-6 presents this structure.

```

struct usbd_xxxx_comm {
    USBD_XXXX_CTRL *CtrlPtr;           (1)
    CPU_INT08U     ClassEpInAddr;      (2)
    CPU_INT08U     ClassEpOutAdd2;     (2)
    ...           (2)
};

```

Listing 7-6 **Class Instance Communication Structure**

- L7-6(1) A pointer to the class instance control structure to which the communication relates to.
- L7-6(2) Class-specific fields. In general, this structure stores mainly endpoint addresses related to the class. Depending on the class, the structure may store other types of information. For instance, the Mass Storage Class stores information about the Command Block and Status Wrappers.

Micrium's USB classes define a class state for each class instance created. The class state values are implemented in the form of an enumeration:

```

typedef enum usbd_xxxx_state {
    USBD_XXXX_STATE_NONE = 0,
    USBD_XXXX_STATE_INIT,
    USBD_XXXX_STATE_CFG
} USBD_XXXX_STATE;

```

Figure 7-4 defines a class state machine which applies to all the Micrium classes. Three class states are used.

Figure 7-4 **Class State Machine**

- F7-4(1) A class instance has been added to a configuration, the class instance state transitions to the 'Init' state. No data communication on the class endpoint(s) can occur yet.
- F7-4(2) The host has sent the **SET_CONFIGURATION** request to activate a certain configuration. The Core layer calls a class callback informing about the completion of the standard enumeration. The class instance state transitions to the 'Cfg' state. This state indicates that the device has transitioned to the 'Configured' state defined by the Universal Serial Bus Specification revision 2.0. The data communication may begin. Some classes such as the MSC class may require that the host sends some class-specific requests before the communication on the endpoints really starts.
- F7-4(3) The Core layer calls another class callback informing that the host has sent a **SET_CONFIGURATION** request with a new configuration number or with the value 0 indicating a configuration reset, or that the device has been physically disconnected from the host. In all these cases, the current active configuration becomes inactive. The class instance state transitions to the 'Init' state. Any ongoing transfers on the endpoints managed by the class instance have been aborted by the Core layer. No more communication is possible until the host sends a new **SET_CONFIGURATION** request with a non-null value or until the device is plugged again to the host.

7-3 CLASS AND CORE LAYERS INTERACTION THROUGH CALLBACKS

Upon reception of standard, class-specific and/or vendor requests, the Core layer can notify the Class layer about the event associated with the request via the use of class callbacks. Each Micrium class must define a class callbacks structure of type `USBD_CLASS_DRV` that contains function pointers. Each callback allows the class to perform a specific action if it is required. Listing 7-7 shows a generic example of class callback structure. In the listing, `XXXX` could be replaced with `CDC`, `HID`, `MSC`, `PHDC` or `Vendor`.

```
static USBD_CLASS_DRV USBD_XXXX_Drv = {
    USBD_XXXX_Conn,                (1)
    USBD_XXXX_Disconn,            (2)
    USBD_XXXX_UpdateAltSetting,    (3)
    USBD_XXXX_UpdateEPState,      (4)
    USBD_XXXX_IFDesc,             (5)
    USBD_XXXX_IFDescGetSize,      (6)
    USBD_XXXX_EPDesc,             (7)
    USBD_XXXX_EPDescGetSize,      (8)
    USBD_XXXX_IFReq,              (9)
    USBD_XXXX_ClassReq,           (10)
    USBD_XXXX_VendorReq           (11)
};
```

Listing 7-7 **Class Callback Structure**

- L7-7(1) Notify the class that a configuration has been activated.
- L7-7(2) Notify the class that a configuration has been deactivated.
- L7-7(3) Notify the class that an alternate interface setting has been updated.
- L7-7(4) Notify the class that an endpoint state has been updated by the host. The state is generally stalled or not stalled.
- L7-7(5) Ask the class to build the interface class-specific descriptors.
- L7-7(6) Ask the class for the total size of interface class-specific descriptors.
- L7-7(7) Ask the class to build endpoint class-specific descriptors.

- L7-7(8) Ask the class for the total size of endpoint class-specific descriptors.
- L7-7(9) Ask the class to process a standard request whose recipient is an interface.
- L7-7(10) Ask the class to process a class-specific request.
- L7-7(11) Ask the class to process a vendor-specific request.

A class is not required to provide all the callbacks. If a class for instance does not define alternate interface settings and does not process any vendor requests, the corresponding function pointer will be a null-pointer. Listing 7-8 presents the callback structure for that case.

```
static USBD_CLASS_DRV USBD_XXXX_Drv = {
    USBD_XXXX_Conn,
    USBD_XXXX_Disconn,
    0,
    USBD_XXXX_UpdateEPState,
    USBD_XXXX_IFDesc,
    USBD_XXXX_IFDescGetSize,
    USBD_XXXX_EPDesc,
    USBD_XXXX_EPDescGetSize,
    USBD_XXXX_IFReq,
    USBD_XXXX_ClassReq,
    0
};
```

Listing 7-8 **Class Callback Structure with Null Function Pointers**

If a class is composed of one interface then one class callback structure is required. If a class is composed of several interfaces then the class may define several class callback structures. In that case, a callback structure may be linked to one or several interfaces. For instance, the Communication Device Class (CDC) is composed of one Communication Interface and one or more Data Interfaces. The Communication interface will be linked to a callback structure. The Data interfaces may be linked to another callback structure common to all Data interfaces.

The class callbacks are called by the core task when receiving a request from the host sent over control endpoints (refer to section 4-2 “Task Model” on page 58 for more details on the core task). Table 7-2 indicates which callbacks are mandatory and optional and upon reception of which request the core task calls a specific callback.

Request type	Callback	Request	Mandatory? / Note
Standard	Conn()	SET_CONFIGURATION	Yes / Host selects a non-null configuration number.
Standard	Disconn()	SET_CONFIGURATION	Yes / Host resets the current configuration or device physically detached from host.
Standard	UpdateAltSetting()	SET_INTERFACE	No / Callback skipped if no alternate settings are defined for one or more interfaces.
Standard	UpdateEPState()	SET_FEATURE CLEAR_FEATURE	No / Callback skipped if the state of the endpoint is not used.
Standard	IFDesc()	GET_DESCRIPTOR	No / Callback skipped if no class-specific descriptors for one or more interfaces.
Standard	IFDescGetSize()	GET_DESCRIPTOR	No / Callback skipped if no class-specific descriptors for one or more interfaces.
Standard	EPDesc()	GET_DESCRIPTOR	No / Callback skipped if no class-specific descriptors for one or more endpoints.
Standard	EPDescGetSize()	GET_DESCRIPTOR	No / Callback skipped if no class-specific descriptors for one or more endpoints.
Standard	IFReq()	GET_DESCRIPTOR	No / Callback skipped if no standard descriptors provided by a class.
Class	ClassReq()	-	No / Callback skipped if no class-specific requests defined by the class specification.
Vendor	VendorReq()	-	No / Callback skipped if no vendor requests.

Table 7-2 Class Callbacks and Requests Mapping

Communications Device Class

This chapter describes the Communications Device Class (CDC) class and the associated CDC subclass supported by μ C/USB-Device. μ C/USB-Device currently supports the Abstract Control Model (ACM) subclass, which is especially used for serial emulation.

The CDC and the associated subclass implementation complies with the following specifications:

- *Universal Serial Bus, Class Definitions for Communications Devices, Revision 1.2*, November 3 2010.
- *Universal Serial Bus, Communications, Subclass for PSTN Devices, revision 1.2*, February 9, 2007.

CDC includes various telecommunication and networking devices. Telecommunication devices encompass analog modems, analog and digital telephones, ISDN terminal adapters, etc. Networking devices contain, for example, ADSL and cable modems, Ethernet adapters and hubs. CDC defines a framework to encapsulate existing communication services standards, such as V.250 (for modems over telephone network) and Ethernet (for local area network devices), using a USB link. A communication device is in charge of device management, call management when needed and data transmission. CDC defines seven major groups of devices. Each group belongs to a model of communication which may include several subclasses. Each group of devices has its own specification besides the CDC base class. The seven groups are:

- Public Switched Telephone Network (PSTN), devices including voiceband modems, telephones and serial emulation devices.
- Integrated Services Digital Network (ISDN) devices, including terminal adaptors and telephones.

- Ethernet Control Model (ECM) devices, including devices supporting the IEEE 802 family (for instance cable and ADSL modems, WiFi adaptors).
- Asynchronous Transfer Mode (ATM) devices, including ADSL modems and other devices connected to ATM networks (workstations, routers, LAN switches).
- Wireless Mobile Communications (WMC) devices, including multi-function communications handset devices used to manage voice and data communications.
- Ethernet Emulation Model (EEM) devices which exchange Ethernet-framed data.
- Network Control Model (NCM) devices, including high-speed network devices (High Speed Packet Access modems, Line Terminal Equipment)

8-1 OVERVIEW

A CDC device is composed of several interfaces to implement a certain function, that is communication capability. It is formed by the following interfaces:

- Communications Class Interface (CCI)
- Data Class Interface (DCI)

A CCI is responsible for the device management and optionally the call management. The device management enables the general configuration and control of the device and the notification of events to the host. The call management enables calls establishment and termination. Call management might be multiplexed through a DCI. A CCI is mandatory for all CDC devices. It identifies the CDC function by specifying the communication model supported by the CDC device. The interface(s) following the CCI can be any defined USB class interface, such as Audio or a vendor-specific interface. The vendor-specific interface is represented specifically by a DCI.

A DCI is responsible for data transmission. The data transmitted and/or received do not follow a specific format. Data could be raw data from a communication line, data following a proprietary format, etc. All the DCIs following the CCI can be seen as subordinate interfaces.

A CDC device must have at least one CCI and zero or more DCIs. One CCI and any subordinate DCI together provide a feature to the host. This capability is also referred to as a function. In a CDC composite device, you could have several functions. Hence, the device would be composed of several sets of CCI and DCI(s) as shown in Figure 8-1.



Figure 8-1 CDC Composite Device

A CDC device is likely to use the following combination of endpoints:

- A pair of control IN and OUT endpoints called the default endpoint.
- An optional bulk or interrupt IN endpoint.
- A pair of bulk or isochronous IN and OUT endpoints.

Table 8-1 indicates the usage of the different endpoints and by which interface of the CDC they are used:

Endpoint	Direction	Interface	Usage
Control IN	Device-to-host	CCI	Standard requests for enumeration, class-specific requests, device management and optionally call management.
Control OUT	Host-to-device	CCI	Standard requests for enumeration, class-specific requests, device management and optionally call management.
Interrupt or bulk IN	Device-to-host	CCI	Events notification, such as ring detect, serial line status, network status.
Bulk or isochronous IN	Device-to-host	DCI	Raw or formatted data communication.
Bulk or isochronous OUT	Host-to-device	DCI	Raw or formatted data communication.

Table 8-1 CDC Endpoint Usage

Most communication devices use an interrupt endpoint to notify the host of events. Isochronous endpoints should not be used for data transmission when a proprietary protocol relies on data retransmission in case of USB protocol errors. Isochronous communication can inherently lose data since it has no retry mechanisms.

The seven major models of communication encompass several subclasses. A subclass describes the way the device should use the CCI to handle the device management and call management. Table 8-2 shows all the possible subclasses and the communication model they belong to.

Subclass	Communication model	Example of devices using this subclass
Direct Line Control Model	PSTN	Modem devices directly controlled by the USB host
Abstract Control Model	PSTN	Serial emulation devices, modem devices controlled through a serial command set
Telephone Control Model	PSTN	Voice telephony devices
Multi-Channel Control Model	ISDN	Basic rate terminal adaptors, primary rate terminal adaptors, telephones
CAPI Control Model	ISDN	Basic rate terminal adaptors, primary rate terminal adaptors, telephones
Ethernet Networking Control Model	ECM	DOC-SIS cable modems, ADSL modems that support PPPoE emulation, Wi-Fi adaptors (IEEE 802.11-family), IEEE 802.3 adaptors
ATM Networking Control Model	ATM	ADSL modems
Wireless Handset Control Model	WMC	Mobile terminal equipment connecting to wireless devices
Device Management	WMC	Mobile terminal equipment connecting to wireless devices
Mobile Direct Line Model	WMC	Mobile terminal equipment connecting to wireless devices
OBEX	WMC	Mobile terminal equipment connecting to wireless devices
Ethernet Emulation Model	EEM	Devices using Ethernet frames as the next layer of transport. Not intended for routing and Internet connectivity devices
Network Control Model	NCM	IEEE 802.3 adaptors carrying high-speed data bandwidth on network

Table 8-2 **CDC Subclasses**

8-2 ARCHITECTURE

Figure 8-2 shows the general architecture between the host and the device using CDC available from Micrium.



Figure 8-2 **General Architecture between a Host and Micrium's CDC**

The host operating system (OS) enumerates the device using the control endpoints. Once the enumeration phase is done, the host can configure the device by sending class-specific requests to the Communications Class Interface (CCI) via the control endpoints. The class-specific requests vary according to the CDC subclasses. Micrium's CDC base class offers the possibility to allocate an interrupt endpoint for event notification, depending on the subclass needs.

Following enumeration and configuration of the device, the host can start the transmission/reception of data to/from the device using the bulk endpoints belonging to the Data Class Interface (DCI). Isochronous endpoints are not supported in the current implementation. The CDC base class enables you to have several DCIs along with the CCI. The application can communicate with the host using the communication API offered by the CDC subclass.

8-3 CONFIGURATION

8-3-1 GENERAL CONFIGURATION

Some constants are available to customize the CDC base class. These constants are located in the USB device configuration file, `usbd_cfg.h`. Table 8-3 shows their description.

Constant	Description
<code>USBD_CDC_CFG_MAX_NBR_DEV</code>	Configures the maximum number of class instances. Each associated subclass also defines a maximum number of subclass instances. The sum of all the maximum numbers of subclass instances must <i>not</i> be greater than <code>USBD_CDC_CFG_MAX_NBR_DEV</code> .
<code>USBD_CDC_CFG_MAX_NBR_CFG</code>	Configures the maximum number of configurations in which CDC class is used. Keep in mind that if you use a high-speed device, two configurations will be built, one for full-speed and another for high-speed.
<code>USBD_CDC_CFG_MAX_NBR_DATA_IF</code>	Configures the maximum number of Data interfaces. The minimum value is 1.

Table 8-3 CDC Class Configuration Constants

Listing 8-1 shows the `App_USBD_CDC_Init()` function defined in the application template file `app_usbd_cdc.c`. This function performs CDC and associated subclass initialization.

```

CPU_BOOLEAN App_USBD_CDC_Init (CPU_INT08U dev_nbr,
                               CPU_INT08U cfg_hs,
                               CPU_INT08U cfg_fs)
{
    USBD_ERR    err;

    USBD_CDC_Init(&err);                (1)

    ...                                  (2)
}

```

Listing 8-1 CDC Initialization Example

-
- L8-1(1) Initialize CDC internal structures and variables. This is the first function you should call and you should do it only once.
- L8-1(2) Call all the required functions to initialize the subclass(es). Refer to section 8-4-2 “General Configuration” on page 123 for ACM subclass initialization.

8-4 ACM SUBCLASS

The ACM subclass is used by two types of communication devices:

- Devices supporting AT commands (for instance, voiceband modems).
- Serial emulation devices which are also called Virtual COM port devices.

Micrium’s ACM subclass implementation complies with the following specification:

- *Universal Serial Bus, Communications, Subclass for PSTN Devices, revision 1.2, February 9, 2007.*

8-4-1 OVERVIEW

The general characteristics of the CDC base class in terms of Communications Class Interface (CCI) and Data Class Interface (DCI) were presented in section 8-1 “Overview” on page 116. In this section, a CCI of type ACM is considered. It will consist of a default endpoint for the management element and an interrupt endpoint for the notification element. A pair of bulk endpoints is used to carry unspecified data over the DCI.

Several subclass-specific requests exist for the ACM subclass. They allow you to control and configure the device. The complete list and description of all ACM requests can be found in the specification “*Universal Serial Bus, Communications, Subclass for PSTN Devices, revision 1.2, February 9, 2007*”, section 6.2.2. From this list, Micrium’s ACM subclass supports:

Subclass request	Description
SetCommFeature	The host sends this request to control the settings for a particular communications feature. Not used for serial emulation.
GetCommFeature	The host sends this request to get the current settings for a particular communications feature. Not used for serial emulation.
ClearCommFeature	The host sends this request to clear the settings for a particular communications feature. Not used for serial emulation.
SetLineCoding	The host sends this request to configure the ACM device settings in terms of baud rate, number of stop bits, parity type and number of data bits. For a serial emulation, this request is sent automatically by a serial terminal each time you configure the serial settings for an open virtual COM port.
GetLineCoding	The host sends this request to get the current ACM settings (baud rate, stop bits, parity, data bits). For a serial emulation, serial terminals send this request automatically during virtual COM port opening.
SetControlLineState	The host sends this request to control the carrier for half duplex modems and indicate that Data Terminal Equipment (DTE) is ready or not. In the serial emulation case, the DTE is a serial terminal. For a serial emulation, certain serial terminals allow you to send this request with the controls set.
SetBreak	The host sends this request to generate an RS-232 style break. For a serial emulation, certain serial terminals allow you to send this request.

Table 8-4 ACM Requests Supported by Micrium

Micrium's ACM subclass uses the interrupt IN endpoint to notify the host about the current *serial line state*. The serial line state is a bitmap informing the host about:

- Data discarded because of overrun
- Parity error
- Framing error
- State of the ring signal detection
- State of break detection mechanism
- State of transmission carrier
- State of receiver carrier detection

8-4-2 GENERAL CONFIGURATION

Table 8-5 shows the constant available to customize the ACM serial emulation subclass. This constant is located in the USB device configuration file, `usbd_cfg.h`.

Constant	Description
<code>USBD_ACM_SERIAL_CFG_MAX_NBR_DEV</code>	Configures the maximum number of subclass instances. The constant value cannot be greater than <code>USBD_CDC_CFG_MAX_NBR_DEV</code> . Unless you plan on having multiple configurations or interfaces using different class instances, this can be set to 1.

Table 8-5 ACM Serial Emulation Subclass Configuration Constants

8-4-3 SUBCLASS INSTANCE CONFIGURATION

Before starting the communication phase, your application needs to initialize and configure the class to suit its needs. Table 8-6 summarizes the initialization functions provided by the ACM subclass. For more details about the functions' parameters, refer to section C-2 "CDC ACM Subclass Functions" on page 369.

Function name	Operation
<code>USBD_ACM_SerialInit()</code>	Initializes ACM subclass internal structures and variables.
<code>USBD_ACM_SerialAdd()</code>	Creates a new instance of ACM subclass.
<code>USBD_ACM_SerialCfgAdd()</code>	Adds an existing ACM instance to the specified device configuration.
<code>USBD_ACM_SerialLineCodingReg()</code>	Registers line coding notification callback.
<code>USBD_ACM_SerialLineCtrlReg()</code>	Registers line control notification callback.

Table 8-6 ACM Subclass Initialization API Summary

You need to call these functions in the order shown below to successfully initialize the ACM subclass:

- 1 Call `USBD_ACM_SerialInit()`

This function initializes all internal structures and variables that the ACM subclass needs. You should call this function only once even if you use multiple class instances.

- 2 Call `USBD_ACM_SerialAdd()`

This function allocates an ACM subclass instance. Internally, this function allocates a CDC class instance. It also allows you to specify the line state notification interval expressed in milliseconds.

- 3 Call `USBD_ACM_SerialLineCodingReg()`

This function allows you to register a callback used by the ACM subclass to notify the application about a change in the serial line coding settings (that is baud rate, number of stop bits, parity and number of data bits).

- 4 Call `USBD_ACM_SerialLineCtrlReg()`

This function allows you to register a callback used by the ACM subclass to notify the application about a change in the serial line state (that is carrier control and a flag indicating that data equipment terminal is present or not).

- 5 Call `USBD_ACM_SerialCfgAdd()`

Finally, once the ACM subclass instance has been created, you must add it to a specific configuration.

Listing 8-2 illustrates the use of the previous functions for initializing the ACM subclass. Note that the error handling has been omitted for clarity.

```

static void          App_USBD_CDC_SerialLineCtrl (CPU_INT08U          (4)          subclass_nbr,
                                                CPU_INT08U          events,
                                                CPU_INT08U          events_chngd,
                                                void                *p_arg);

static CPU_BOOLEAN  App_USBD_CDC_SerialLineCoding(CPU_INT08U          (5)          subclass_nbr,
                                                USBD_ACM_SERIAL_LINE_CODING *p_line_coding,
                                                void                *p_arg);

CPU_BOOLEAN  App_USBD_CDC_Init (CPU_INT08U  dev_nbr,
                               CPU_INT08U  cfg_hs,
                               CPU_INT08U  cfg_fs)
{
    USBD_ERR    err;
    CPU_INT08U  subclass_nbr;

    USBD_CDC_Init(&err);                (1)

    USBD_ACM_SerialInit(&err);          (2)

    subclass_nbr = USBD_ACM_SerialAdd(100u, &err); (3)
                                                (4)

    USBD_ACM_SerialLineCodingReg(        subclass_nbr,
                                        App_USBD_CDC_SerialLineCoding,
                                        (void *)0,
                                        &err);
                                                (5)

    USBD_ACM_SerialLineCtrlReg(          subclass_nbr,
                                        App_USBD_CDC_SerialLineCtrl,
                                        (void *)0,
                                        &err);

    if (cfg_hs != USBD_CFG_NBR_NONE) {
        USBD_ACM_SerialCfgAdd(subclass_nbr, dev_nbr, cfg_hs, &err); (6)
    }

    if (cfg_fs != USBD_CFG_NBR_NONE) {
        USBD_ACM_SerialCfgAdd(subclass_nbr, dev_nbr, cfg_fs, &err); (7)
    }
}

```

Listing 8-2 **CDC ACM Subclass Initialization Example**

-
- 8
- L8-2(1) Initialize CDC internal structures and variables.
 - L8-2(2) Initialize CDC ACM internal structures and variables.
 - L8-2(3) Create a new CDC ACM subclass instance. In this example, the line state notification interval is 100 ms. In the CCI, an interrupt IN endpoint is used to asynchronously notify the host of the status of the different signals forming the serial line. The line state notification interval corresponds to the interrupt endpoint's polling interval.
 - L8-2(4) Register the application callback, `App_USBD_CDC_SerialLineCoding()`. It is called by the ACM subclass when the class-specific request `SET_LINE_CODING` has been received by the device. This request allows the host to specify the serial line settings (baud rate, stop bits, parity and data bits). Refer to “*CDC PSTN Subclass, revision 1.2*”, section 6.3.10 for more details about this class-specific request.
 - L8-2(5) Register the application callback, `App_USBD_CDC_SerialLineCtrl()`. It is called by the ACM subclass when the class-specific request `SET_CONTROL_LINE_STATE` has been received by the device. This request generates RS-232/V.24 style control signals. Refer to “*CDC PSTN Subclass, revision 1.2*”, section 6.3.12 for more details about this class-specific request.
 - L8-2(6) Check if the high-speed configuration is active and proceed to add the ACM subclass instance to this configuration.
 - L8-2(7) Check if the full-speed configuration is active and proceed to add the ACM subclass instance to this configuration.

Listing 8-2 also illustrates an example of multiple configurations. The functions `USBDCM_SerialAdd()` and `USBDCM_SerialCfgAdd()` allow you to create multiple configurations and multiple instances architecture. Refer to section 7-1 “Class Instance Concept” on page 99 for more details about multiple class instances.

8-4-4 SUBCLASS NOTIFICATION AND MANAGEMENT

You have access to some functions provides in the ACM subclass which relate to the ACM requests and the serial line state previously presented in section 8-4-1 “Overview” on page 121. Table 8-7 shows these functions. Refer to section C-2 “CDC ACM Subclass Functions” on page 369 for more details about the functions’ parameters.

Function	Relates to...	Description
USBD_ACM_SerialLineCodingGet()	SetLineCoding	Application can get the current line coding settings set either by the host with SetLineCoding requests or by USBD_ACM_SerialLineCodingSet()
USBD_ACM_SerialLineCodingSet()	GetLineCoding	Application can set the line coding. The host can retrieve the settings with the GetLineCoding request.
USBD_ACM_SerialLineCodingReg()	SetLineCoding	Application registers a callback called by the ACM subclass upon reception of the SetLineCoding request. Application can perform any specific operations.
USBD_ACM_SerialLineCtrlGet()	SetControlLineState	Application can get the current control line state set by the host with the SetControlLineState request.
USBD_ACM_SerialLineCtrlReg()	SetControlLineState	Application registers a callback called by the ACM subclass upon reception of the SetControlLineState request. Application can perform any specific operations.
USBD_ACM_SerialLineStateSet()	Serial line state	Application can set any line state event(s). While setting the line state, an interrupt IN transfer is sent to the host to inform about it a change in the serial line state.
USBD_ACM_SerialLineStateClr()	Serial line state	Application can clear two events of the line state: transmission carrier and receiver carrier detection. All the other events are self-cleared by the ACM serial emulation subclass.

Table 8-7 ACM Subclass Functions Related to the Subclass Requests and Notifications

Micrium’s ACM subclass always uses the interrupt endpoint to notify the host of the serial line state. You cannot disable the interrupt endpoint.

8-4-5 SUBCLASS INSTANCE COMMUNICATION

Micrium's ACM subclass offers the following functions to communicate with the host. For more details about the functions' parameters, refer to section C-2 "CDC ACM Subclass Functions" on page 369.

Function name	Operation
USBD_ACM_SerialRx()	Receives data from host through a bulk OUT endpoint. This function is blocking.
USBD_ACM_SerialTx()	Sends data to host through a bulk IN endpoint. This function is blocking.

Table 8-8 CDC ACM Communication API Summary

USBD_ACM_SerialRx() and USBD_ACM_SerialTx() provide synchronous communication which means that the transfer is blocking. Upon calling the function, the application blocks until transfer completion with or without an error. A timeout can be specified to avoid waiting forever. Listing 8-3 presents a read and write example to receive data from the host using the bulk OUT endpoint and to send data to the host using the bulk IN endpoint.

```

CPU_INT08U rx_buf[2];
CPU_INT08U tx_buf[2];
USBD_ERR   err;

(void)USBD_ACM_SerialRx(subclass_nbr,           (1)
                        &rx_buf[0],           (2)
                        2u,
                        0u,                     (3)
                        &err);
if (err != USBD_ERR_NONE) {
    /* Handle the error. */
}

(void)USBD_ACM_SerialTx(subclass_nbr,           (1)
                        &tx_buf[0],           (4)
                        2u,
                        0u,                     (3)
                        &err);
if (err != USBD_ERR_NONE) {
    /* Handle the error. */
}

```

Listing 8-3 Serial Read and Write Example

-
- L8-3(1) The class instance number created with `USBD_ACM_SerialAdd()` will serve internally to the ACM subclass to route the transfer to the proper bulk OUT or IN endpoint.
- L8-3(2) The application must ensure that the buffer provided to the function is large enough to accommodate all the data. Otherwise, synchronization issues might happen.
- L8-3(3) In order to avoid an infinite blocking situation, a timeout expressed in milliseconds can be specified. A value of '0' makes the application task wait forever.
- L8-3(4) The application provides the initialized transmit buffer.

8-4-6 USING THE DEMO APPLICATION

Micrium provides a demo application that lets you test and evaluate the class implementation. Source template files are provided for the device.

CONFIGURING DEVICE APPLICATION

The *serial* demo allows you to send and/or receive serial data to and/or from the device through a virtual COM port. The demo is implemented in the application file, `app_usbd_cdc.c`, provided for μ C/OS-II and μ C/OS-III. `app_usbd_cdc.c` is located in these two folders:

- `\Micrium\Software\uC-USB-Device-V4\App\Device\OS\uCOS-II`
- `\Micrium\Software\uC-USB-Device-V4\App\Device\OS\uCOS-III`

Table 8-9 describes the constants usually defined in `app_cfg.h` which allows you to use the serial demo.

Constant	Description
<code>APP_CFG_USBD_CDC_EN</code>	General constant to enable the CDC ACM demo application. Must be set to <code>DEF_ENABLED</code> .
<code>APP_CFG_USBD_CDC_SERIAL_TEST_EN</code>	Constant to enable the serial demo. Must be set to <code>DEF_ENABLED</code> .
<code>APP_CFG_USBD_CDC_SERIAL_TASK_Prio</code>	Priority of the task used by the serial demo.
<code>APP_CFG_USBD_CDC_SERIAL_TASK_STK_SIZE</code>	Stack size of the task used by the serial demo. A default value can be 256.

Table 8-9 Device Application Configuration Constants

RUNNING THE DEMO APPLICATION

In this section, we will assume Windows as the host operating system. Upon connection of your CDC ACM device, Windows will enumerate your device and load the native driver `usbser.sys` to handle the device communication. The first time you connect your device to the host, you will have to indicate to Windows which driver to load using an INF file (refer to section 3-1-1 “About INF Files” on page 46 for more details about INF). The INF file tells Windows to load the `usbser.sys` driver. Indicating the INF file to Windows has to be done only once. Windows will then automatically recognize the CDC ACM device and load the proper driver for any new connection. The process of indicating the INF file may vary according to the Windows operating system version:

- Windows XP directly opens the Found New Hardware Wizard. Follow the different steps of the wizard until you reach the page where you can indicate the path of the INF file.
- Windows Vista and later won't open a “Found New Hardware Wizard”. It will just indicate that no driver was found for the vendor device. You have to manually open the wizard. When you open the Device Manager, your CDC ACM device should appear with a yellow icon. Right-click on your device and choose ‘Update Driver Software...’ to open the wizard. Follow the different steps of the wizard until the page where you can indicate the path of the INF file.

The INF file is located in:

```
\Micrium\Software\uC-USB-Device-V4\App\Host\OS\Windows\CDC\INF
```

Refer to section 3-1-1 “About INF Files” on page 46 for more details about how to edit the INF file to match your Vendor ID (VID) and Product ID (PID). The provided INF files define, by default, **0xFFFFE** for VID and **0x1234** for PID. Once the driver is loaded, Windows creates a virtual COM port as shown in Figure 8-3.



Figure 8-3 Windows Device Manager and Created Virtual COM Port

Figure 8-4 presents the steps to follow to use the serial demo.

Figure 8-4 **Serial Demo**

- F8-4(1) Open a serial terminal (for instance, HyperTerminal). Open the COM port matching to your CDC ACM device with the serial settings (baud rate, stop bits, parity and data bits) you want. This operation will send a series of CDC ACM class-specific requests (`GET_LINE_CODING`, `SET_LINE_CODING`, `SET_CONTROL_LINE_STATE`) to your device. Note that Windows Vista and later don't provide HyperTerminal anymore. You may use other free serial terminals such *TeraTerm* (<http://ttssh2.sourceforge.jp/>), *Hercules* (http://www.hw-group.com/products/hercules/index_en.html), *RealTerm* (<http://realterm.sourceforge.net/>), etc.
- F8-4(2) In order to start the communication with the serial task on the device side, the Data Terminal Ready (DTR) signal must be set and sent to the device. The DTR signal prevents the serial task from sending characters if the terminal is not ready to receive data. Sending the DTR signal may vary depending on your serial terminal. For example, *HyperTerminal* sends a properly set DTR signal automatically upon opening of the COM port. *Hercules* terminal allows you to set and clear the DTR signal from the graphical user interface (GUI) with a checkbox. Other terminals do not permit to set/clear DTR or the DTR set/clear's functionality is difficult to find and to use.
- F8-4(3) Once the serial task receives the DTR signal, the task sends a menu to the serial terminal with two options as presented in Figure 8-5.

- F8-4(4) The menu option #1 is the *Echo 1 demo*. It allows you to send one unique character to the device. This character is received by the serial task and sent back to the host.
- F8-4(5) The menu options #2 is the *Echo N demo*. It allows you to send several characters to the device. All the characters are received by the serial task and sent back to the host. The serial task can receive a maximum of 512 characters.



Figure 8-5 **CDC Serial Demo Menu in HyperTerminal**

To support the two demos, the serial task implements a state machine as shown in Figure 8-6. Basically, the state machine has two paths corresponding to the user choice in the serial terminal menu.

Figure 8-6 **Serial Demo State Machine**

- F8-6(1) Once the DTR signal has been received, the serial task is in the MENU state.
- F8-6(2) If you choose the menu option #1, the serial task will echo back any single character sent by the serial terminal as long as “Ctrl+C” is not pressed.
- F8-6(3) If you choose the menu option #2, the serial task will echo all the received characters sent by the serial terminal as long as “Ctrl+C” is not pressed.

Table 8-10 shows four possible serial terminals which you may use to test the CDC ACM class.

Terminal	DTR set/clear	Menu option(s) usable
HyperTerminal	Yes (properly set DTR signal automatically sent upon COM port opening)	1 and 2
Hercules	Yes (a checkbox in the GUI allows you to set/clear DTR)	1 and 2
RealTerm	Yes (Set/Clear DTR buttons in the GUI)	1 and 2
TeraTerm	Yes (DTR can be set using a macro. GUI does NOT allows you to set/clear DTR easily)	1 and 2

Table 8-10 **Serial Terminals and CDC Serial Demo**

Human Interface Device Class

This chapter describes the Human Interface Device (HID) class supported by μ C/USB-Device. The HID implementation complies with the following specifications:

- *Device Class Definition for Human Interface Devices (HID), 6/27/01, Version 1.11.*
- *Universal Serial Bus HID Usage Tables, 10/28/2004, Version 1.12.*

The HID class encompasses devices used by humans to control computer operations. Keyboards, mice, pointing devices, game devices are some examples of typical HID devices. The HID class can also be used in a composite device that contains some controls such as knobs, switches, buttons and sliders. For instance, mute and volume controls in an audio headset are controlled by the HID function of the headset. The headset also has an audio function. HID data can exchange data for any purpose using only control and interrupt transfers. The HID class is one of the oldest and most popular USB classes. All the major host operating systems provide a native driver to manage HID devices. That's why a variety of vendor-specific devices work with the HID class. This class also includes various types of output directed to the user information (e.g. LEDs on a keyboard).

9-1 OVERVIEW

A HID device is composed of the following endpoints:

- A pair of control IN and OUT endpoints called the default endpoint.
- An interrupt IN endpoint.
- An optional interrupt OUT endpoint.

Table 9-1 describes the usage of the different endpoints:

Endpoint	Direction	Usage
Control IN	Device-to-host	Standard requests for enumeration, class-specific requests, and data communication (Input, Feature reports sent to the host with <code>GET_REPORT</code> request).
Control OUT	Host-to-device	Standard requests for enumeration, class-specific requests and data communication (Output, Feature reports received from the host with <code>SET_REPORT</code> request).
Interrupt IN	Device-to-host	Data communication (Input and Feature reports).
Interrupt OUT	Host-to-device	Data communication (Output and Feature reports).

Table 9-1 **HID Class Endpoints Usage**

9-1-1 REPORT

A host and a HID device exchange data using reports. A report contains formatted data giving information about controls and other physical entities of the HID device. A control is manipulable by the user and operates an aspect of the device. For instance, a control can be a button on a mouse or a keyboard, a switch, etc. Other entities inform the user about the state of certain device's features. For instance, LEDs on a keyboard notify the user about the caps lock on, about the numeric keypad active, etc.

The format and the use of a report data is understood by the host by analyzing the content of a *Report descriptor*. Analyzing the content is done by a parser. The Report descriptor describes the data provided by each control in a device. It is composed of *items*. An item is a piece of information about the device and consists of a 1-byte prefix and variable-length data. Refer to “*Device Class Definition for Human Interface Devices (HID) Version 1.11*”, section 5.6 and 6.2.2 for more details about the item format.

There are three principal types of items:

- *Main item* defines or groups certain types of data fields.
- *Global item* describes data characteristics of a control.
- *Local item* describes data characteristics of a control.

Each item type is defined by different functions. An item function can also be called an item. An item function can be seen as a sub-item that belongs to one of the 3 principal item types. Table 9-2 gives a brief overview of the item’s functions in each item type. For a complete description of the items in each category, refer to “*Device Class Definition for Human Interface Devices (HID) Version 1.11*”, section 6.2.2.

Item type	Item function	Description
Main	Input	Describes information about the data provided by one or more physical controls.
	Output	Describes data sent to the device.
	Feature	Describes device configuration information sent to or received from the device which influences the overall behavior of the device or one of its components.
	Collection	Group related items (Input, Output or Feature).
	End of Collection	Closes a collection.

Item type	Item function	Description
Global	Usage Page	Identifies a function available within the device.
	Logical Minimum	Defines the lower limit of the reported values in logical units.
	Logical Maximum	Defines the upper limit of the reported values in logical units.
	Physical Minimum	Defines the lower limit of the reported values in physical units, that is the Logical Minimum expressed in physical units.
	Physical Maximum	Defines the upper limit of the reported values in physical units, that is the Logical Maximum expressed in physical units.
	Unit Exponent	Indicates the unit exponent in base 10. The exponent ranges from -8 to +7.
	Unit	Indicates the unit of the reported values. For instance, length, mass, temperature units, etc.
	Report Size	Indicates the size of the report fields in bits.
	Report ID	Indicates the prefix added to a particular report.
	Report Count	Indicates the number of data fields for an item.
	Push	Places a copy of the global item state table on the CPU stack.
	Pop	Replaces the item state table with the last structure from the stack.
Local	Usage	Represents an index to designate a specific Usage within a Usage Page. It indicates the vendor's suggested use for a specific control or group of controls. A usage supplies information to an application developer about what a control is actually measuring.
	Usage Minimum	Defines the starting usage associated with an array or bitmap.
	Usage Maximum	Defines the ending usage associated with an array or bitmap.
	Designator Index	Determines the body part used for a control. Index points to a designator in the Physical descriptor.
	Designator Minimum	Defines the index of the starting designator associated with an array or bitmap.
	Designator Maximum	Defines the index of the ending designator associated with an array or bitmap.
	String Index	String index for a String descriptor. It allows a string to be associated with a particular item or control.
	String Minimum	Specifies the first string index when assigning a group of sequential strings to controls in an array or bitmap.
	String Maximum	Specifies the last string index when assigning a group of sequential strings to controls in an array or bitmap.
	Delimiter	Defines the beginning or end of a set of local items.

Table 9-2 Item's Function Description for each Item Type

A control's data must define at least the following items:

- Input, Output or Feature Main items.
- Usage Local item.
- Usage Page Global item.
- Logical Minimum Global item.
- Logical Maximum Global item.
- Report Size Global item.
- Report Count Global item.

Table 9-1 shows the representation of a Mouse Report descriptor content from a host HID parser perspective. The mouse has three buttons (left, right and wheel). The code presented in Listing 9-2 is an example of code implementation corresponding to this mouse Report descriptor representation.



Figure 9-1 Report Descriptor Content from a Host HID Parser View

-
- F9-1(1) The *Usage Page* item function specifies the general function of the device. In this example, the HID device belongs to a generic desktop control.
- F9-1(2) The *Collection Application* groups Main items that have a common purpose and may be familiar to applications. In the diagram, the group is composed of three Input Main items. For this collection, the suggested use for the controls is a mouse as indicated by the *Usage* item.
- F9-1(3) Nested collections may be used to give more details about the use of a single control or group of controls to applications. In this example, the Collection Physical, nested into the Collection Application, is composed of the same 3 Input items forming the Collection Application. The *Collection Physical* is used for a set of data items that represent data points collected at one geometric point. In the example, the suggested use is a pointer as indicated by the Usage item. Here the pointer usage refers to the mouse position coordinates and the system software will translate the mouse coordinates in movement of the screen cursor.
- F9-1(4) Nested usage pages are also possible and give more details about a certain aspect within the general function of the device. In this case, two Input items are grouped and correspond to the buttons of the mouse. One Input item defines the three buttons of the mouse (right, left and wheel) in terms of number of data fields for the item (*Report Count* item), size of a data field (*Report Size* item) and possible values for each data field (*Usage Minimum* and *Maximum*, *Logical Minimum* and *Maximum* items). The other Input item is a 13-bit constant allowing the Input report data to be aligned on a byte boundary. This Input item is used only for padding purpose.
- F9-1(5) Another nested usage page referring to a generic desktop control is defined for the mouse position coordinates. For this usage page, the Input item describes the data fields corresponding to the x- and y-axis as specified by the two Usage items.

After analyzing the previous mouse Report descriptor content, the host's HID parser is able to interpret the Input report data sent by the device with an interrupt IN transfer or in response to a `GET_REPORT` request. The Input report data corresponding to the mouse Report descriptor shown in Figure 9-1 is presented in Table 9-3. The total size of the report data is 4 bytes. Different types of reports may be sent over the same endpoint. For the purpose of distinguishing the different types of reports, a 1-byte report ID prefix is added to the data report. If a report ID was used in the example of the mouse report, the total size of the report data would be 5 bytes.

Bit offset	Bit count	Description
0	1	Button 1 (left button).
1	1	Button 2 (right button).
2	1	Button 3 (wheel button).
3	13	Not used.
16	8	Position on axis X.
24	8	Position on axis Y.

Table 9-3 **Input Report Sent to Host and Corresponding to the State of a 3-Buttons Mouse.**

A Physical descriptor indicates the part or parts of the body intended to activate a control or controls. An application may use this information to assign a functionality to the control of a device. A Physical descriptor is an optional class-specific descriptor and most devices have little gain for using it. Refer to “Device Class Definition for Human Interface Devices (HID) Version 1.11” section 6.2.3 for more details about this descriptor.

9-2 ARCHITECTURE

Figure 9-2 shows the general architecture between the host and the device using the HID class offered by Micrium.

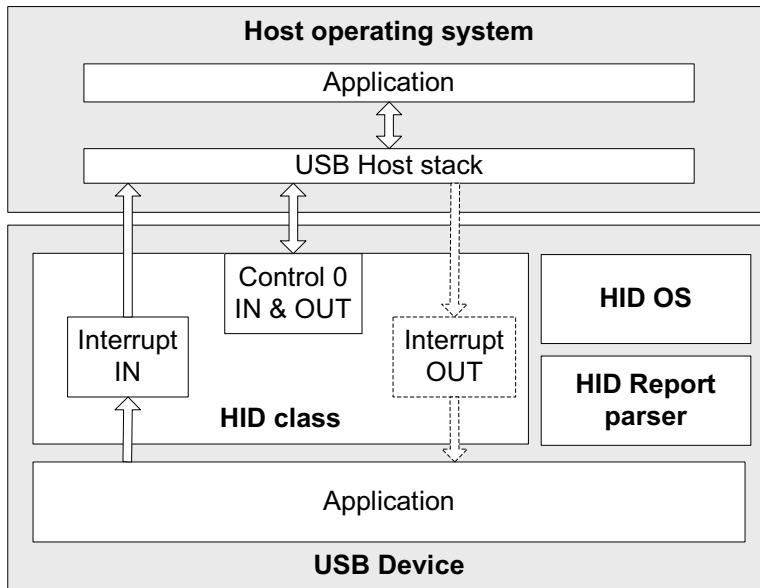

Figure 9-2 General Architecture Between a Host and HID Class

The host operating system (OS) enumerates the device using the control endpoints. Once the enumeration phase is done, the host starts the transmission/reception of reports to/from the device using the interrupt endpoints.

On the device side, the HID class interacts with an OS layer specific to this class. The HID OS layer provides specific OS services needed for the internal functioning of the HID class. This layer does not assume a particular OS. By default, Micrium provides the HID OS layer for $\mu\text{C}/\text{OS-II}$ and $\mu\text{C}/\text{OS-III}$. If you need to port the HID class to your own OS, refer to section 9-5 “Porting the HID Class to a RTOS” on page 160 for more details about the HID OS layer.

During the HID class initialization phase, a report parser module is used to validate the report provided by the application. If any error is detected during the report validation, the initialization will fail.

9-3 CONFIGURATION

9-3-1 GENERAL CONFIGURATION

Some constants are available to customize the class. These constants are located in the USB device configuration file, `usbd_cfg.h`. Table 9-4 shows their description.

Constant	Description
<code>USBD_HID_CFG_MAX_NBR_DEV</code>	Configures the maximum number of class instances. Unless you plan on having multiple configurations or interfaces using different class instances, this can be set to 1.
<code>USBD_HID_CFG_MAX_NBR_CFG</code>	Configures the maximum number of configurations in which HID class is used. Keep in mind that if you use a high-speed device, two configurations will be built, one for full-speed and another for high-speed.
<code>USBD_HID_CFG_MAX_NBR_REPORT_ID</code>	Configures the maximum number of report IDs allowed in a report. The value should be set properly to accommodate the number of report ID to be used in the report. The minimum value is 1.
<code>USBD_HID_CFG_MAX_NBR_REPORT_PUSHPOP</code>	Configures the maximum number of Push and Pop items used in a report. If the constant is set to 0, no Push and Pop items are present in the report.

Table 9-4 **HID Class Configuration Constants**

The HID class uses an internal class to manage periodic input reports. The task priority and stack size shown in Table 9-5 are defined in the application configuration file, `app_cfg.h`. Refer to section 9-6 “Periodic Input Reports Task” on page 161 for more details about the HID internal task.

Constant	Description
<code>USBD_HID_OS_CFG_TMR_TASK_PRIO</code>	Configures the priority of the HID periodic input reports task.
<code>USBD_HID_OS_CFG_TMR_TASK_STK_SIZE</code>	Configures the stack size of the HID periodic input reports task.

Table 9-5 **HID Internal Task’s Configuration Constants**

9-3-2 CLASS INSTANCE CONFIGURATION

Before starting the communication phase, your application needs to initialize and configure the class to suit its needs. Table 9-6 summarizes the initialization functions provided by the HID class. For more details about the functions parameters, refer to Appendix D, “HID API Reference” on page 387.

Function name	Operation
<code>USBD_HID_Init()</code>	Initializes HID class internal structures, variables and the OS layer.
<code>USBD_HID_Add()</code>	Creates a new instance of HID class.
<code>USBD_HID_CfgAdd()</code>	Adds an existing HID instance to the specified device configuration.

Table 9-6 HID Class Initialization API Summary

You need to call these functions in the order shown below to successfully initialize the HID class:

1 Call `USBD_HID_Init()`

This is the first function you should call and you should do it only once even if you use multiple class instances. This function initializes all internal structures and variables that the class needs and also the HID OS layer.

2 Call `USBD_HID_Add()`

This function allocates an HID class instance. It also allows you to specify the following instance characteristics:

- The country code of the localized HID hardware.
- The Report descriptor content and size.
- The Physical descriptor content and size.
- The polling interval for the interrupt IN endpoint.
- The polling interval for the interrupt OUT endpoint.

- A flag enabling or disabling the Output reports reception with the control endpoint. When the control endpoint is not used, the interrupt OUT endpoint is used instead to receive Output reports.
- A structure that contains 4 application callbacks used for class-specific requests processing.

3 Call `USBD_HID_CfgAdd()`

Finally, once the HID class instance has been created, you must add it to a specific configuration.

Listing 9-1 illustrates the use of the previous functions for initializing the HID class.

```

static USBD_HID_CALLBACK App_USBD_HID_Callback = {                               (3)
    App_USBD_HID_GetFeatureReport,
    App_USBD_HID_SetFeatureReport,
    App_USBD_HID_GetProtocol,
    App_USBD_HID_SetProtocol,
};

CPU_BOOLEAN App_USBD_HID_Init (CPU_INT08U dev_nbr,
                               CPU_INT08U cfg_hs,
                               CPU_INT08U cfg_fs)
{
    USBD_ERR    err;
    CPU_INT08U  class_nbr;

    USBD_HID_Init(&err);                                                         (1)
    if (err != USBD_ERR_NONE) {
        /* Handle the error. */
    }
}                                                                                (2)

```

```

class_nbr = USBD_HID_Add(
    USBD_HID_SUBCLASS_BOOT,
    USBD_HID_PROTOCOL_MOUSE,
    USBD_HID_COUNTRY_CODE_NOT_SUPPORTED,
    &App_USB_D_HID_ReportDesc[0],
    sizeof(App_USB_D_HID_ReportDesc),
    (CPU_INT08U *)0,
    0u,
    2u,
    2u,
    DEF_YES,
    &App_USB_D_HID_Callback,    (3)
    &err);

if (err != USBD_ERR_NONE) {
    /* Handle the error. */
}

if (cfg_hs != USBD_CFG_NBR_NONE) {
    USBD_HID_CfgAdd(class_nbr, dev_nbr, cfg_hs, &err);    (4)
    if (err != USBD_ERR_NONE) {
        /* Handle the error. */
    }
}

if (cfg_fs != USBD_CFG_NBR_NONE) {
    USBD_HID_CfgAdd(class_nbr, dev_nbr, cfg_fs, &err);    (5)
    if (err != USBD_ERR_NONE) {
        /* Handle the error. */
    }
}
}
}

```

Listing 9-1 HID Class Initialization Example

- L9-1(1) Initialize HID internal structures, variables and OS layer.
- L9-1(2) Create a new HID class instance. In this example, the subclass is “Boot”, the protocol is “Mouse” and the country code is unknown. A table, `App_USB_D_HID_ReportDesc[]`, representing the Report descriptor is passed to the function (refer to Listing 9-2 for an example of Report descriptor content and section 9-1-1 “Report” on page 136 for more details about the Report descriptor format). No Physical descriptor is provided by the application. The interrupt IN endpoint is used and has a 2 frames or microframes polling interval. The use of the control endpoint to receive Output reports is enabled. The interrupt OUT endpoint will not be used. Hence, the interrupt OUT polling

interval of 2 is ignored by the class. The structure `App_USBD_HID_Callback` is also passed and references 4 application callbacks which will be called by the HID class upon processing of the class-specific requests.

- L9-1(3) There are 4 application callbacks for class-specific requests processing. There is one callback for each of the following requests: `GET_REPORT`, `SET_REPORT`, `GET_PROTOCOL` and `SET_PROTOCOL`. Refer to “Device Class Definition for Human Interface Devices (HID) Version 1.11”, section 7.2 for more details about these class-specific requests.
- L9-1(4) Check if the high-speed configuration is active and proceed to add the HID instance previously created to this configuration.
- L9-1(5) Check if the full-speed configuration is active and proceed to add the HID instance to this configuration.

Listing 9-1 also illustrates an example of multiple configurations. The functions `USBD_HID_Add()` and `USBD_HID_CfgAdd()` allow you to create multiple configurations and multiple instances architecture. Refer to section Table 7-1 “Constants and Functions Related to the Concept of Multiple Class Instances” on page 99 for more details about multiple class instances.

Listing 9-2 presents an example of table declaration defining a Report descriptor corresponding to a mouse. The example matches the mouse report descriptor viewed by the host HID parser in Figure 9-1. The mouse report represents an Input report. Refer to section 9-1-1 “Report” on page 136 for more details about the Report descriptor format. The items inside a collection are intentionally indented for code clarity.

```

static CPU_INT08U App_USBD_HID_ReportDesc[] = {
    USBD_HID_GLOBAL_USAGE_PAGE      + 1, USBD_HID_USAGE_PAGE_GENERIC_DESKTOP_CONTROLS, (1)
    USBD_HID_LOCAL_USAGE             + 1, USBD_HID_CA_MOUSE, (3)
    USBD_HID_MAIN_COLLECTION         + 1, USBD_HID_COLLECTION_APPLICATION, (4)
    USBD_HID_LOCAL_USAGE             + 1, USBD_HID_CP_POINTER, (5)
    USBD_HID_MAIN_COLLECTION         + 1, USBD_HID_COLLECTION_PHYSICAL, (6)
                                     (7)

    USBD_HID_GLOBAL_USAGE_PAGE      + 1, USBD_HID_USAGE_PAGE_BUTTON,
    USBD_HID_LOCAL_USAGE_MIN         + 1, 0x01,
    USBD_HID_LOCAL_USAGE_MAX         + 1, 0x03,
    USBD_HID_GLOBAL_LOG_MIN          + 1, 0x00,
    USBD_HID_GLOBAL_LOG_MAX          + 1, 0x01,
    USBD_HID_GLOBAL_REPORT_COUNT     + 1, 0x03,
    USBD_HID_GLOBAL_REPORT_SIZE     + 1, 0x01,
    USBD_HID_MAIN_INPUT              + 1, USBD_HID_MAIN_DATA |
                                     USBD_HID_MAIN_VARIABLE |
                                     USBD_HID_MAIN_ABSOLUTE, (8)

    USBD_HID_GLOBAL_REPORT_COUNT     + 1, 0x01,
    USBD_HID_GLOBAL_REPORT_SIZE     + 1, 0x0D,
    USBD_HID_MAIN_INPUT              + 1, USBD_HID_MAIN_CONSTANT, (9)

    USBD_HID_GLOBAL_USAGE_PAGE      + 1, USBD_HID_USAGE_PAGE_GENERIC_DESKTOP_CONTROLS,
    USBD_HID_LOCAL_USAGE             + 1, USBD_HID_DV_X,
    USBD_HID_LOCAL_USAGE             + 1, USBD_HID_DV_Y,
    USBD_HID_GLOBAL_LOG_MIN          + 1, 0x81,
    USBD_HID_GLOBAL_LOG_MAX          + 1, 0x7F,
    USBD_HID_GLOBAL_REPORT_SIZE     + 1, 0x08,
    USBD_HID_GLOBAL_REPORT_COUNT     + 1, 0x02,
    USBD_HID_MAIN_INPUT              + 1, USBD_HID_MAIN_DATA |
                                     USBD_HID_MAIN_VARIABLE |
                                     USBD_HID_MAIN_RELATIVE,

    USBD_HID_MAIN_ENDCOLLECTION, (10)
    USBD_HID_MAIN_ENDCOLLECTION (11)
};

```

Listing 9-2 Mouse Report Descriptor Example

L9-2(1) The table representing a mouse Report descriptor is initialized in such way that each line corresponds to a short item. The latter is formed from a 1-byte prefix and a 1-byte data. Refer to “Device Class Definition for Human Interface Devices (HID) Version 1.11”, sections 5.3 and 6.2.2.2 for more details about short items format. This table content corresponds to the mouse Report descriptor content viewed by a host HID parser in Figure 9-1.

L9-2(2) The Generic Desktop Usage Page is used.

-
- L9-2(3) Within the Generic Desktop Usage Page, the usage tag suggests that the group of controls is for controlling a mouse. A mouse collection typically consists of two axes (X and Y) and one, two, or three buttons.
- L9-2(4) The mouse collection is started.
- L9-2(5) Within the mouse collection, a usage tag suggests more specifically that the mouse controls belong to the pointer collection. A pointer collection is a collection of axes that generates a value to direct, indicate, or point user intentions to an application.
- L9-2(6) The pointer collection is started.
- L9-2(7) The Buttons Usage Page defines an Input item composed of three 1-bit fields. Each 1-bit field represents the mouse's button 1, 2 and 3 respectively and can return a value of 0 or 1.
- L9-2(8) The Input Item for the Buttons Usage Page is padded with 13 other bits.
- L9-2(9) Another Generic Desktop Usage Page is indicated for describing the mouse position with the axes X and Y. The Input item is composed of two 8-bit fields whose value can be between -127 and 127.
- L9-2(10) The pointer collection is closed.
- L9-2(11) The mouse collection is closed.

9-3-3 CLASS INSTANCE COMMUNICATION

The HID class offers the following functions to communicate with the host. For more details about the functions parameters, refer to Appendix D, “HID API Reference” on page 387.

Function name	Operation
USBD_HID_Rd()	Receives data from host through interrupt OUT endpoint. This function is blocking.
USBD_HID_Wr()	Sends data to host through interrupt IN endpoint. This function is blocking.
USBD_HID_RdAsync()	Receives data from host through interrupt OUT endpoint. This function is non-blocking.
USBD_HID_WrAsync()	Sends data to host through interrupt IN endpoint. This function is non-blocking.

Table 9-7 HID Communication API Summary

9-3-4 SYNCHRONOUS COMMUNICATION

Synchronous communication means that the transfer is blocking. Upon function call, the applications blocks until the transfer completion with or without an error. A timeout can be specified to avoid waiting forever.

Listing 9-3 presents a read and write example to receive data from the host using the interrupt OUT endpoint and to send data to the host using the interrupt IN endpoint.

```

CPU_INT08U  rx_buf[2];
CPU_INT08U  tx_buf[2];
USBD_ERR    err;

(void)USBD_HID_Rd(      class_nbr,          (1)
                      (void *)&rx_buf[0], (2)
                      2u,
                      0u,                  (3)
                      &err);
if (err != USBD_ERR_NONE) {
    /* $$$$ Handle the error. */
}

(void)USBD_HID_Wr(      class_nbr,          (1)
                      (void *)&tx_buf[0], (4)
                      2u,
                      0u,                  (3)
                      &err);
if (err != USBD_ERR_NONE) {
    /* $$$$ Handle the error. */
}

```

Listing 9-3 Synchronous Bulk Read and Write Example

- L9-3(1) The class instance number created from `USBD_HID_Add()` will serve internally for the HID class to route the transfer to the proper interrupt OUT or IN endpoint.
- L9-3(2) The application must ensure that the buffer provided to the function is large enough to accommodate all the data. Otherwise, synchronization issues might happen. Internally, the read operation is done either with the control endpoint or with the interrupt endpoint depending on the control read flag set when calling `USBD_HID_Add()`.
- L9-3(3) In order to avoid an infinite blocking situation, a timeout expressed in milliseconds can be specified. A value of '0' makes the application task wait forever.
- L9-3(4) The application provides the initialized transmit buffer.

9-3-5 ASYNCHRONOUS COMMUNICATION

Asynchronous communication means that the transfer is non-blocking. Upon function call, the application passes the transfer information to the device stack and does not block. Other application processing can be done while the transfer is in progress over the USB bus. Once the transfer is completed, a callback is called by the device stack to inform the application about the transfer completion.

Listing 9-4 shows an example of an asynchronous read and write.

```

void App_USBD_HID_Comm (CPU_INT08U  class_nbr)
{
    CPU_INT08U  rx_buf[2];
    CPU_INT08U  tx_buf[2];
    USBD_ERR    err;

    USBD_HID_RdAsync(          class_nbr,          (1)
                        (void *)&rx_buf[0],      (2)
                        2u,
                        App_USBD_HID_RxCmpl,      (3)
                        (void *) 0u,              (4)
                        &err);

    if (err != USBD_ERR_NONE) {
        /* Handle the error. */
    }

    USBD_HID_WrAsync(          class_nbr,          (1)
                        (void *)&tx_buf[0],      (5)
                        2u,
                        App_USBD_HID_TxCmpl,      (3)
                        (void *) 0u,              (4)
                        &err);

    if (err != USBD_ERR_NONE) {
        /* $$$ Handle the error. */
    }
}
(3)

static void App_USBD_HID_RxCmpl (CPU_INT08U  class_nbr,
                                void          *p_buf,
                                CPU_INT32U    buf_len,
                                CPU_INT32U    xfer_len,
                                void          *p_callback_arg,
                                USBD_ERR      err)

```



```
{
  (void)class_nbr;
  (void)p_buf;
  (void)buf_len;
  (void)xfer_len;
  (void)p_callback_arg;                                (4)

  if (err == USBD_ERR_NONE) {
    /* $$$$ Do some processing. */
  } else {
    /* $$$$ Handle the error. */
  }
}

static void App_USBD_HID_TxCmpl (CPU_INT08U  class_nbr,      (3)
                                 void         *p_buf,
                                 CPU_INT32U  buf_len,
                                 CPU_INT32U  xfer_len,
                                 void         *p_callback_arg,
                                 USBD_ERR    err)

{
  (void)class_nbr;
  (void)p_buf;
  (void)buf_len;
  (void)xfer_len;
  (void)p_callback_arg;                                (4)

  if (err == USBD_ERR_NONE) {
    /* $$$$ Do some processing. */
  } else {
    /* $$$$ Handle the error. */
  }
}
```

Listing 9-4 Asynchronous Bulk Read and Write Example

- L9-4(1) The class instance number serves internally for the HID class to route the transfer to the proper interrupt OUT or IN endpoint.
- L9-4(2) The application must ensure that the buffer provided to the function is large enough to accommodate all the data. Otherwise, synchronization issues might happen. Internally, the read operation is done either with the control endpoint or with the interrupt endpoint depending on the control read flag set when calling `USBD_HID_Add()`.

- L9-4(3) The application provides a callback passed as a parameter. Upon completion of the transfer, the device stack calls this callback so that the application can finalize the transfer by analyzing the transfer result. For instance, upon read operation completion, the application may do a certain processing with the received data. Upon write completion, the application may indicate if the write was successful and how many bytes were sent.
- L9-4(4) An argument associated to the callback can be also passed. Then in the callback context, some private information can be retrieved.
- L9-4(5) The application provides the initialized transmit buffer.

9-4 USING THE DEMO APPLICATION

Micrium provides a demo application that lets you test and evaluate the class implementation. Source template files are provided for the device. Executable and source files are provided for Windows host PC.

9-4-1 CONFIGURING PC AND DEVICE APPLICATIONS

The HID class provides two demos:

- *Mouse* demo exercises Input reports sent to the host. Each report gives periodically the current state of a simulated mouse.
- *Vendor-specific* demo exercises Input and Output reports. The host sends an Output report or receives an Input report according to your choice.

On the device side, the demo application file, `app_usbd_hid.c`, offering the two HID demos is provided for $\mu\text{C}/\text{OS-II}$ and $\mu\text{C}/\text{OS-III}$. It is located in these two folders:

- `\Micrium\Software\uC-USB-Device-V4\App\Device\OS\uCOS-II`
- `\Micrium\Software\uC-USB-Device-V4\App\Device\OS\uCOS-III`

The use of these constants usually defined in `app_cfg.h` allows you to use one of the HID demos.

Constant	Description
APP_CFG_USBD_HID_EN	General constant to enable the Vendor class demo application. Must be set to DEF_ENABLED.
APP_CFG_USBD_HID_TEST_MOUSE_EN	Enables or disables the mouse demo. The possible values are DEF_ENABLED or DEF_DISABLED. If the constant is set to DEF_DISABLED, the vendor-specific demo is enabled.
APP_CFG_USBD_HID_MOUSE_TASK_PRIO	Priority of the task used by the mouse demo.
APP_CFG_USBD_HID_READ_TASK_PRIO	Priority of the read task used by the vendor-specific demo.
APP_CFG_USBD_HID_WRITE_TASK_PRIO	Priority of the write task used by the vendor-specific demo.
APP_CFG_USBD_HID_TASK_STK_SIZE	Stack size of the tasks used by mouse or vendor-specific demo. A default value can be 256.

Table 9-8 Device Application Constants Configuration

On the Windows side, the mouse demo influences directly the cursor on your monitor while the vendor-specific demo requires a custom application. The latter is provided by a Visual Studio solution located in this folder:

- `\Micrium\Software\uC-USB-Device-V4\App\Host\OS\Windows\HID\Visual Studio 2010`

The solution `HID.sln` contains two projects:

- “HID - Control” tests the Input and Output reports transferred through the control endpoints. The class-specific requests `GET_REPORT` and `SET_REPORT` allows the host to receive Input reports and send Output reports respectively.
- “HID - Interrupt” tests the Input and Output reports transferred through the interrupt IN and OUT endpoints.

An HID device is defined by a Vendor ID (VID) and Product ID (PID). The VID and PID will be retrieved by the host during the enumeration to build a string identifying the HID device. The “HID - Control” and “HID - Interrupt” projects contain both a file named `app_hid_common.c`. This file declares the following local constant:

```
static const TCHAR App_DevPathStr[] = _TEXT("hid#vid_fffe&pid_1234");           (1)
```

Listing 9-5 **Windows Application and String to Detect a Specific HID Device**

L9-5(1) This constant allows the application to detect a specified HID device connected to the host. The VID and PID given in `App_DevPathStr` variable must match with device side values. The device side VID and PID are defined in the `USBD_DEV_CFG` structure in the file `usbd_dev_cfg.c`. Refer to the section “Modify Device Configuration” on page 34 for more details about the `USBD_DEV_CFG` structure. In this example, VID = `fffe` and PID = `1234` in hexadecimal format.

9-4-2 RUNNING THE DEMO APPLICATION

The *mouse demo* does not require anything on the Windows side. You just need to plug the HID device running the mouse demo to the PC and see the screen cursor moving.

Figure 9-3 presents the mouse demo with the host and device interactions:

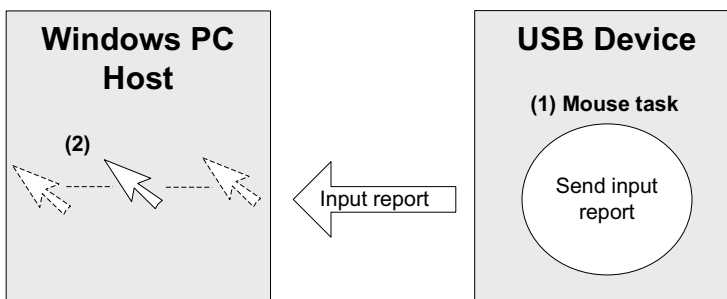

Figure 9-3 **HID Mouse Demo**

- F9-3(1) On the device side, the task `App_USBD_HID_MouseTask()` simulates a mouse movement by setting the coordinates X and Y to a certain value and by sending the Input report that contains these coordinates. The Input report is sent by calling the `USBD_HID_Wr()` function through the interrupt IN endpoint. The mouse demo does not simulate any button clicks; only mouse movement.
- F9-3(2) The host Windows PC polls the HID device periodically following the polling interval of the interrupt IN endpoint. The polling interval is specified in the Endpoint descriptor matching to the interrupt IN endpoint. The host receives and interprets the Input report content. The simulated mouse movement is translated into a movement of the screen cursor. While the device side application is running, the screen cursor moves endlessly.

The *vendor-specific demo* requires you to launch a Windows executable. Two executables are already provided in the following folder:

- `\Micrium\Software\uC-USB-Device-V4\App\Host\OS\Windows\HID\Visual Studio 2010\exe\`

The two executables have been generated with a Visual Studio 2010 project available in `\Micrium\Software\uC-USB-Device-V4\App\Host\OS\Windows\HID\Visual Studio 2010\`.

- *HID - Control.exe* for the vendor-specific demo utilizing the control endpoints to send Output reports or receive Input reports.
- *HID - Interrupt.exe* for the vendor-specific demo utilizing the interrupt endpoints to send Output reports or receive Input reports.

Figure 9-4 presents the vendor-specific demo with the host and device interactions:



Figure 9-4 HID Vendor-Specific Demo

- F9-4(1) A menu will appear after launching *HID - Control.exe*. You will have three choices: “1. Sent get report”, “2. Send set report” and “3. Exit”. Choice 1 will send a `GET_REPORT` request to obtain an Input report from the device. The content of the Input report will be displayed in the console. Choice 2 will send a `SET_REPORT` request to send an Output report to the device.
- F9-4(2) A menu will appear after launching *HID - Interrupt.exe*. You will have three choices: “1. Read from device”, “2. Write from device” and “3. Exit”. The choice 1 will initiate an interrupt IN transfer to obtain an Input report from the device. The content of the Input report will be displayed in the console. Choice 2 will initiate an interrupt OUT transfer to send an Output report to the device.
- F9-4(3) On the device side, the task `App_USBD_HID_ReadTask()` is used to receive Output reports from the host. The synchronous HID read function, `USBD_HID_Rd()`, will receive the Output report data. Nothing is done with the received data. The Output report has a size of 4 bytes.
- F9-4(4) Another task, `App_USBD_HID_WriteTask()`, will send Input reports to the host using the synchronous HID write function, `USBD_HID_Wr()`. The Input report has a size of 4 bytes.

Figure 9-5 and Figure 9-6 show screenshot examples corresponding to HID - Control.exe and HID - Interrupt.exe respectively.

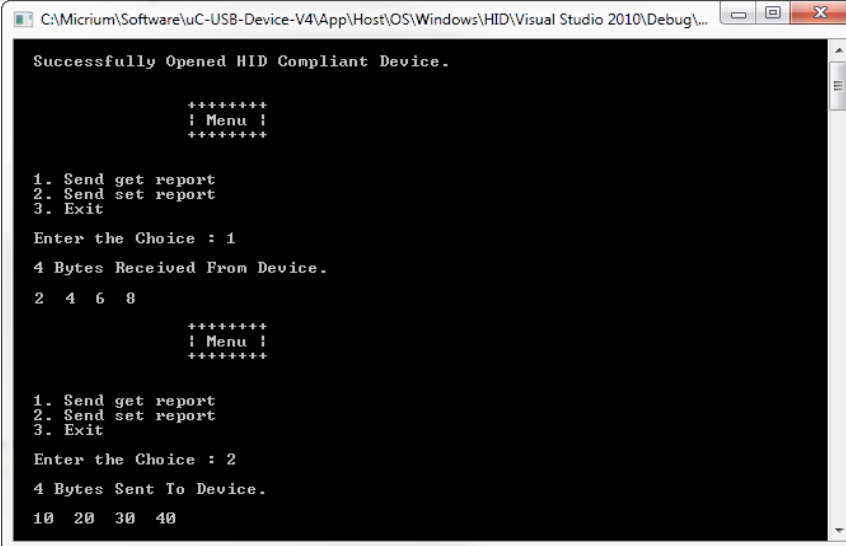

```

C:\Micrium\Software\uC-USB-Device-V4\App\Host\OS\Windows\HID\Visual Studio 2010\Debug\...
Successfully Opened HID Compliant Device.

          ++++++
          ! Menu !
          ++++++

1. Send get report
2. Send set report
3. Exit

Enter the Choice : 1
4 Bytes Received From Device.

2  4  6  8

          ++++++
          ! Menu !
          ++++++

1. Send get report
2. Send set report
3. Exit

Enter the Choice : 2
4 Bytes Sent To Device.

10 20 30 40
  
```

Figure 9-5 HID - Control.exe (Vendor-Specific Demo)



```

C:\Micrium\Software\uC-USB-Device-V4\App\Host\OS\Windows\HID\Visual Studio 2010\Debug\...
Successfully Opened HID Compliant Device.

          ++++++
          ! Menu !
          ++++++

1. Read from Device
2. Write to Device
3. Exit

Enter the Choice : 1

Last 4 Bytes Received From Device.

2  4  6  8

          ++++++
          ! Menu !
          ++++++

1. Read from Device
2. Write to Device
3. Exit

Enter the Choice : 2

Sent 4 Bytes to Device: 10 20 30 40
  
```

Figure 9-6 HID - Interrupt.exe (Vendor-Specific Demo)

9-5 PORTING THE HID CLASS TO A RTOS

The HID class uses its own RTOS layer for different purposes:

- A locking system is used to protect a given Input report. A host can get an Input report by sending a `GET_REPORT` request to the device using the control endpoint or with an interrupt IN transfer. `GET_REPORT` request processing is done by the device stack while the interrupt IN transfer is done by the application. When the application executes the interrupt IN transfer, the Input report data is stored internally. This report data stored will be sent via a control transfer when `GET_REPORT` is received. The locking system ensures the data integrity between the Input report data storage operation done within an application task context and the `GET_REPORT` request processing done within the device stack's internal task context.
- A locking system is used to protect the Output report processing between an application task and the device stack's internal task when the control endpoint is used. The application provides to the HID class a receive buffer for the Output report in the application task context. This receive buffer will be used by the device stack's internal task upon reception of a `SET_REPORT` request. The locking system ensures the receive buffer and related variables integrity.
- A locking system is used to protect the interrupt IN endpoint access from multiple application tasks.
- A synchronization mechanism is used to implement the blocking behavior of `USBD_HID_Rd()` when the control endpoint is used.
- A synchronization mechanism is used to implement the blocking behavior of `USBD_HID_Wr()` because the HID class internally uses the asynchronous interrupt API for HID write.
- A task is used to process periodic Input reports. Refer to section 9-6 “Periodic Input Reports Task” on page 161 for more details about this task.

By default, Micrium will provide an RTOS layer for both $\mu\text{C}/\text{OS-II}$ and $\mu\text{C}/\text{OS-III}$. However, it is possible to create your own RTOS layer. Your layer will need to implement the functions listed in Table 9-9. For a complete API description, refer to Appendix D, “HID API Reference” on page 387.

Function name	Operation
USBD_HID_OS_Init()	Creates and initializes the task and semaphores.
USBD_HID_OS_InputLock()	Locks Input report.
USBD_HID_OS_InputUnlock()	Unlocks Input report.
USBD_HID_OS_InputDataPend()	Waits for Input report data write completion.
USBD_HID_OS_InputDataPendAbort()	Aborts the wait for Input report data write completion.
USBD_HID_OS_InputDataPost()	Signals that Input report data has been sent to the host.
USBD_HID_OS_OutputLock()	Locks Output report.
USBD_HID_OS_OutputUnlock()	Unlocks Output report.
USBD_HID_OS_OutputDataPend()	Waits for Output report data read completion.
USBD_HID_OS_OutputDataPendAbort()	Aborts the wait for Output report data read completion.
USBD_HID_OS_OutputDataPost()	Signals that Output report data has been received from the host.
USBD_HID_OS_TxLock()	Locks class transmit.
USBD_HID_OS_TxUnlock()	Unlocks class transmit.
USBD_HID_OS_TmrTask()	Task processing periodic input reports. Refer to section 9-6 "Periodic Input Reports Task" on page 161 for more details about this task.

Table 9-9 HID OS Layer API Summary

9-6 PERIODIC INPUT REPORTS TASK

In order to save bandwidth, the host has the ability to silence a particular report in an interrupt IN endpoint by limiting the reporting frequency. The host sends the **SET_IDLE** request to realize this operation. The HID class implemented by Micrium contains an internal task responsible for respecting the reporting frequency limitation applying to one or several input reports. Figure 9-7 shows the periodic input reports tasks functioning.



Figure 9-7 Periodic Input Reports Task

- F9-7(1) The device receives a **SET_IDLE** request. This request specifies an idle duration for a given report ID. This request refers to “Device Class Definition for Human Interface Devices (HID) Version 1.11”, section 7.2.4 for more details about the **SET_IDLE** request. A report ID allows you to distinguish among the different types of reports sent over the same endpoint.
- F9-7(2) A report ID structure allocated during the HID class initialization phase is updated with the idle duration. An idle duration counter is initialized with the idle duration value. Then the report ID structure is inserted at the end of a linked list containing input reports ID structures. The idle duration value is expressed in 4-ms unit which gives a range of 4 to 1020 ms. If the idle duration is less than the interrupt IN endpoint polling interval, the reports are generated at the polling interval.
- F9-7(3) Every 4 ms, the periodic input report task browses the input reports ID list. For each input report ID, the task performs one of two possible operations. The task period matches the 4-ms unit used for the idle duration. If no **SET_IDLE**

requests have been sent by the host, the input reports ID list is empty and the task has nothing to process. The task processes only report IDs different from 0 and with an idle duration greater than 0.

- F9-7(4) For a given input report ID, the task verifies if the idle duration has elapsed. If the idle duration has not elapsed, the counter is decremented and no input report is sent to the host.
- F9-7(5) If the idle duration has elapsed, that is the idle duration counter has reached zero, an input report is sent to the host by calling the `USBD_HID_Wr()` function via the interrupt IN endpoint.
- F9-7(6) The input report data sent by the task comes from an internal data buffer allocated for each input report described in the Report descriptor. An application task can call the `USBD_HID_Wr()` function to send an input report. After sending the input report data, `USBD_HID_Wr()` updates the internal buffer associated to an input report ID with the data just sent. Then, the periodic input reports task always sends the same input report data after each idle duration elapsed and until the application task updates the data in the internal buffer. There is some locking mechanism to avoid corruption of the input report ID data in the event of a modification happening at the exact time of transmission done by the periodic input report task.

The periodic input reports task is implemented in the HID OS layer in the function `USBD_HID_OS_TmrTask()`. Refer to section D-2 “HID OS Functions” on page 402 for more details about this function.

Mass Storage Class

This section describes the mass storage device class (MSC) supported by μ C/USB-Device. The MSC implementation offered by μ C/USB-Device is in compliance with the following specifications:

- *Universal Serial Bus Mass Storage Class Specification Overview*, Revision 1.3 Sept. 5, 2008.
- *Universal Serial Bus Mass Storage Class Bulk-Only Transport*, Revision 1.0 Sept. 31, 1999.

MSC is a protocol that enables the transfer of information between a USB device and a host. The information is anything that can be stored electronically: executable programs, source code, documents, images, configuration data, or other text or numeric data. The USB device appears as an external storage medium to the host, enabling the transfer of files via drag and drop.

A file system defines how the files are organized in the storage media. The USB mass storage class specification does not require any particular file system to be used on conforming devices. Instead, it provides a simple interface to read and write sectors of data using the Small Computer System Interface (SCSI) transparent command set. As such, operating systems may treat the USB drive like a hard drive and can format it with any file system they like.

The USB mass storage device class supports two transport protocols:

- Bulk-Only Transport (BOT)
- Control/Bulk/Interrupt (CBI) Transport.

The mass storage device class supported by μ C/USB-Device implements the SCSI transparent command set using the BOT protocol only, which signifies that only bulk endpoints will be used to transmit data and status information.

10-1 OVERVIEW

10-1-1 MASS STORAGE CLASS PROTOCOL

The MSC protocol is composed of three phases:

- The Command Transport
- The Data Transport
- The Status Transport

Mass storage commands are sent by the host through a structure called the Command Block Wrapper (CBW). For commands requiring a data transport stage, the host will attempt to send or receive the exact number of bytes from the device as specified by the length and flag fields of the CBW. After the data transport stage, the host attempts to receive a Command Status Wrapper (CSW) from the device detailing the status of the command as well as any data residue (if any). For commands that do not include a data transport stage, the host attempts to receive the CSW directly after CBW is sent. The protocol is detailed in Figure 10-1.



Figure 10-1 MSC Protocol

10-1-2 ENDPOINTS

On the device side, in compliance with the BOT specification, the MSC is composed of the following endpoints:

- A pair of control IN and OUT endpoints called default endpoint.
- A pair of bulk IN and OUT endpoints.

Table 10-1 indicates the different usages of the endpoints.

Endpoint	Direction	Usage
Control IN Control OUT	Device to Host Host to Device	Enumeration and MSC class-specific requests
Bulk IN Bulk OUT	Device to Host Host to Device	Send CSW and data Receive CBW and data

Table 10-1 **MSC Endpoint Usage**

10-1-3 MASS STORAGE CLASS REQUESTS

There are two defined control requests for the MSC BOT protocol. These requests and their descriptions are detailed in Table 10-2.

Class Requests	Description
Bulk-Only Mass Storage Reset	This request is used to reset the mass storage device and its associated interface. This request readies the device to receive the next command block.
Get Max LUN	This request is used to return the highest logical unit number (LUN) supported by the device. For example, a device with LUN 0 and LUN 1 will return a value of 1. A device with a single logical unit will return 0 or stall the request. The maximum value that can be returned is 15.

Table 10-2 **Mass Storage Class Requests**

10-1-4 SMALL COMPUTER SYSTEM INTERFACE (SCSI)

SCSI is a set of standards for handling communication between computers and peripheral devices. These standards include commands, protocols, electrical interfaces and optical interfaces. Storage devices that use other hardware interfaces such as USB, use SCSI commands for obtaining device/host information and controlling the device's operation and transferring blocks of data in the storage media.

SCSI commands cover a vast range of device types and functions and as such, devices need a subset of these commands. In general, the following commands are necessary for basic communication:

- INQUIRY
- READ CAPACITY (10)
- READ(10)
- REQUEST SENSE
- TEST UNIT READY
- WRITE(10)

Refer to Table 10-3 to see the full list of implemented SCSI commands by μ C/USB-Device.

10-2 ARCHITECTURE

10-2-1 MSC ARCHITECTURE

Figure 10-2 shows the general architecture of a USB Host and a USB MSC Device.



Figure 10-2 **MSC Architecture**

On the host side, the application communicates with the MSC device by interacting with the native mass storage drivers and SCSI drivers. In compliance with the BOT specification, the host utilizes the default control endpoint to enumerate the device and the Bulk IN/OUT endpoints to communicate with the device.

10-2-2 SCSI COMMANDS

The host sends SCSI commands to the device via the Command Descriptor Block (CDB). These commands set specific requests for transfer of blocks of data and status, and control information such as a device's capacity and readiness to exchange data. The μ C/USB MSC Device supports the following subset of SCSI Primary and Block Commands detailed in Table 10-3.

SCSI Command	Function
INQUIRY	Requests the device to return a structure that contains information about itself. A structure shall be returned by the device despite of the media's readiness to respond to other commands. Refer to SCSI Primary Commands documentation for the full command description.
TEST UNIT READY	Requests the device to return a status to know if the device is ready to use. Refer to SCSI Primary Commands documentation for the full command description.
READ CAPACITY (10)	Requests the device to return how many bytes a device can store. Refer to SCSI Block Commands documentation for the full command description.
READ (10)	Requests to read a block of data from the device's storage media. Please refer to SCSI Block Commands documentation for the full command description.
WRITE (10)	Requests to write a block of data to the device's storage media. Refer to SCSI Block Commands documentation for the full command description.
VERIFY (10)	Requests the device to test one or more sectors. Refer to SCSI Block Commands documentation for the full command description.
MODE SENSE (6) and (10)	Requests parameters relating to the storage media, logical unit or the device itself. Refer to SCSI Primary Commands documentation for the full command description.
REQUEST SENSE	Requests a structure containing sense data. Refer to SCSI Primary Commands documentation for the full command description.
PREVENT ALLOW MEDIA REMOVAL	Requests the device to prevent or allow users to remove the storage media from the device. Refer to SCSI Primary Commands documentation for the full command description.

Table 10-3 **SCSI Commands**

10-2-3 STORAGE LAYER AND STORAGE MEDIUM

The storage layer is the interface between the μ C/USB MSC Device and the file system storage medium. The storage layer is responsible of initializing, reading and writing to the storage medium as well as obtaining information regarding its capacity and status. By default, Micrium will provide a storage layer implementation (named RAMDisk) by utilizing the hardware's platform memory as storage medium. Aside from this implementation, you have the option to use Micrium's μ C/FS or even utilize a file system storage medium of your own. In the event you use a file system storage medium of your own, you will need to create a storage layer port to communicate your storage medium to the μ C/USB MSC Device. Please refer to section 10-6 "Porting MSC to a Storage Layer" on page 180 to learn how to implement this storage layer.

10-3 RTOS LAYER

MSC device communication relies on a task handler that implements the MSC protocol. This task handler needs to be notified when the device is properly enumerated before communication begins. Once communication begins, the task must also keep track of endpoint update statuses to correctly implement the MSC protocol. These types of notification are handled by RTOS signals. For the MSC RTOS layer, there are two semaphores created. One for enumeration process and one for communication process. By default, Micrium will provide RTOS layers for both μ C/OS-II and μ C/OS-III. However, it is also possible to create your own RTOS layer. Please refer to section 10-7 "Porting MSC to a RTOS" on page 181 to learn how to port to a different RTOS.

10-3-1 MASS STORAGE TASK HANDLER

The MSC task handler implements the MSC protocol, responsible for the communication between the device and the host. The task handler is initialized when `USBD_MSC_Init()` is called. The MSC protocol is handled by a state machine comprised of 9 states. The transition between these states are detailed in Figure 10-3.



Figure 10-3 MSC State Machine

Upon detecting that the MSC device is connected, the device will enter an infinite loop waiting to receive the first CBW from the host. Depending on the command received, the device will either enter the data phase or transmit CSW phase. In the event of any stall conditions in the data phase, the host must clear the respective endpoint before transitioning to the CSW phase. If an invalid CBW is received from the host, the device shall enter reset recovery state where both endpoints are stalled to complete the full reset with the host issuing the Bulk-Only Mass Storage Reset Class Request. After a successful CSW phase or a reset recovery, the task will return to receive the next CBW command. If at any stage the device is disconnected from the host the state machine will transition to the None state.

10-4 CONFIGURATION

10-4-1 GENERAL CONFIGURATION

There are various configuration constants necessary to customize the MSC device. These constants are located in the `usbd_cfg.h` file. Table 10-4 shows a description of each constant.

Constant	Description
<code>USBD_MSC_CFG_MAX_NBR_DEV</code>	Configures the maximum number of class instances. Unless you plan having multiple configuration or interfaces using different class instances, this should be set to 1.
<code>USBD_MSC_CFG_MAX_NBR_CFG</code>	Configures the maximum number of configuration in which MSC is used. Keep in mind that if you use a high-speed device, two configurations will be built, one for full-speed and another for high-speed.
<code>USBD_MSC_CFG_MAX_LUN</code>	Configures the maximum number of logical units. This value must be at least 1.
<code>USBD_MSC_CFG_DATA_LEN</code>	Configures the read/write data length in octets. The default value set is 2048

Table 10-4 **MSC Configuration Constants**

Since MSC device relies on a task handler to implement the MSC protocol, this OS-task's priority and stack size constants need to be configured. These constants are summarized in Table 10-5.

Constant	Description
<code>USBD_MSC_OS_CFG_TASK_PRIO</code>	MSC task handler's priority level. The priority level must be lower (higher valued) than the start task and core task priorities.
<code>USBD_MSC_OS_CFG_TASK_STK_SIZE</code>	MSC task handler's stack size. Default value is set to 256.

Table 10-5 **MSC OS-Task Handler Configuration Constants**

10-4-2 CLASS INSTANCE CONFIGURATION

Before starting the communication phase, your application needs to initialize and configure the class to suit its needs. Table 10-6 summarizes the initialization functions provided by the MSC implementation. Please refer to section E-1 “Mass Storage Class Functions” on page 420 for a full listing of the MSC API.

Function name	Operation
USBD_MSC_Init()	Initializes MSC internal structures and variables.
USBD_MSC_Add()	Adds a new instance of the MSC.
USBD_MSC_CfgAdd()	Adds existing MSC instance into USB device configuration.
USBD_MSC_LunAdd()	Adds a LUN to the MSC interface.

Table 10-6 **Class Instance API Functions**

To successfully initialize the MSC, you need to follow these steps:

- 1 Call `USBD_MSC_Init()`

This is the first function you should call, and it should be called only once regardless of the number of class instances you intend to have. This function will initialize all internal structures and variables that the class will need. It will also initialize the real-time operating system (RTOS) layer.

- 2 Call `USBD_MSC_Add()`

This function will add a new instance of the MSC.

- 3 Call `USBD_MSC_CfgAdd()`

Once the class instance is correctly configured and initialized, you will need to add it to a USB configuration. High speed devices will build two separate configurations, one for full speed and one for high speed by calling `USBD_MSC_CfgAdd()` for each speed configuration.

4 Call `USBD_MSC_LunAdd()`

Lastly, you add a logical unit to the MSC interface by calling this function. You will specify the type and volume of the logical unit you want to add as well as device details such as vendor ID, product ID, product revision level and read only. Logical units are added by a device driver string name composed of the storage device driver name and the logical unit number as follows: `<device_driver_name>:<logical_unit_number>.` The logical unit number starts counting from number 0. For example, if a device has only one logical unit, the `<logical_unit_number>` specified in this field should be 0.

Listing 10-1 shows how the latter functions are called during MSC initialization.

```
USBD_ERR    err;
CPU_INT08U  msc_nbr;
CPU_BOOLEAN valid;

USBD_MSC_Init(&err);                                (1)
if (err != USBD_ERR_NONE){
    return (DEF_FAIL);
}

msc_nbr = USBD_MSC_Add(&err);                         (2)
if (cfg_hs != USBD_CFG_NBR_NONE){
    valid = USBD_MSC_CfgAdd (msc_nbr,                (3)
                             dev_nbr,
                             cfg_hs,
                             &err);

    if (valid != DEF_YES) {
        return (DEF_FAIL);
    }
}

if (cfg_fs != USBD_CFG_NBR_NONE){
    valid = USBD_MSC_CfgAdd (msc_nbr,                (4)
                             dev_nbr,
                             cfg_fs,
                             &err);

    if (valid != DEF_YES) {
        return (DEF_FAIL);
    }
}
}
```

```
USB_D_MSC_LunAdd((void *)"ram:0:",           (5)
                 msc_nbr,
                 "Micrium",
                 "MSC RamDisk",
                 0x0000,
                 DEF_FALSE,
                 &err);
if (err != USB_D_ERR_NONE){
    return (DEF_FAIL);
}

return(DEF_OK);
```

Listing 10-1 **MSC Initialization**

- L10-1(1) Initialize internal structures and variables used by MSC BOT.
- L10-1(2) Add a new instance of the MSC.
- L10-1(3) Check if high speed configuration is active and proceed to add an existing MSC interface to the USB configuration.
- L10-1(4) Check if full speed configuration is active and proceed to add an existing MSC interface to the USB configuration.
- L10-1(5) Add a logical unit number to the MSC interface by specifying the type and volume. Note that in this example the *<device_driver_name>* string is "ram" and *<logical_unit_number>* string is "0".

10-5 USING THE DEMO APPLICATION

The MSC demo consists of two parts:

- Any file explorer application (Windows, Linux, Mac) from a USB host. For instance, in Windows, mass-storage devices appear as drives in *My Computer*. From Windows Explorer, users can copy, move, and delete files in the devices.
- The USB Device application on the target board which responds to the request of the host.

μC/USB Device allows the explorer application to access a MSC device such as a NAND/NOR Flash memory, RAM disk, Compact Flash, Secure Digital etc. Once the device is configured for MSC and is connected to the PC host, the operating system will try to load the necessary drivers to manage the communication with the MSC device. For example, Windows loads the built-in drivers *disk.sys* and *PartMgr.sys*. You will be able to interact with the device through the explorer application to validate the device stack with MSC.

10-5-1 USB DEVICE APPLICATION

On the target side, the user configures the application through the `app_cfg.h` file. Table 10-7 lists a few preprocessor constants that must be defined.

Preprocessor Constants	Description	Default Value
APP_CFG_USBD_EN	Enables μC/USB Device in the application.	DEF_ENABLED
APP_CFG_USBD_MSC_EN	Enables MSC in the application.	DEF_ENABLED

Table 10-7 Application Preprocessor Constants

If RAMDisk storage is used, ensure that the associated storage layer files are included in the project and configure the following constants detailed in Table 10-8.

Preprocessor Constants	Description	Default Value
USBD_RAMDISK_CFG_NBR_UNITS	Number of RAMDISK units.	1
USBD_RAMDISK_CFG_BLK_SIZE	RAMDISK block size.	512
USBD_RAMDISK_CFG_NBR_BLKS	RAMDISK number of blocks.	(4*1024*1)
USBD_RAMDISK_CFG_BASE_ADDR	RAMDISK base address in memory. This constant is optional and is used to define the data area of the RAMDISK. If it is defined, RAMDISK's data area will be set from this base address directly. If it is not defined, RAMDISK's data area will be represented as a table from the program's data area.	0XA000000

Table 10-8 RAM Disk Preprocessor Constants

If μ C/FS storage is used, ensure that the associated μ C/FS storage layer files are included in the project and configure the following constants detailed in Table 10-8:

Preprocessor Constant	Description	Default Value
APP_CFG_FS_EN	Enables μ C/FS in the application	DEF_ENABLED
APP_CFG_FS_DEV_CNT	File system device count.	1
APP_CFG_FS_VOL_CNT	File system volume count.	1
APP_CFG_FS_FILE_CNT	File system file count.	2
APP_CFG_FS_DIR_CNT	File system directory count.	1
APP_CFG_FS_BUF_CNT	File system buffer count.	(2 * APP_CFG_FS_VOL_CNT)
APP_CFG_FS_DEV_DRV_CNT	File system device driver count.	1
APP_CFG_FS_WORKING_DIR_CNT	File system working directory count.	0
APP_CFG_FS_MAX_SEC_SIZE	File system max sector size.	512
APP_CFG_FS_RAM_NBR_SEC	File system number of RAM sectors.	8192
APP_CFG_FS_RAM_SEC_SIZE	File system RAM sector size.	512
APP_CFG_FS_NBR_TEST	File system number of tests.	10
APP_CFG_FS_IDE_EN	Enables IDE device in file system.	DEF_DISABLED
APP_CFG_FS_MSC_EN	Enables MSC device in file system.	DEF_DISABLED
APP_CFG_FS_NOR_EN	Enables NOR device in file system.	DEF_DISABLED
APP_CFG_FS_RAM_EN	Enables RAM device in file system.	DEF_ENABLED
APP_CFG_FS_SD_EN	Enables SD device in file system.	DEF_DISABLED
APP_CFG_FS_SD_CARD_EN	Enables SD card device in file system.	DEF_ENABLED

Table 10-9 μ C/FS Preprocessor Constants

10-5-2 USB HOST APPLICATION

To test the μ C/USB-Device stack with MSC, the user can use the Windows Explorer as a USB Host application.

When the device configured for the MSC demo is connected to the PC, Windows loads the appropriate drivers as shown in Figure 10-4.



Figure 10-4 MSC Device Driver Detection on Windows Host

Open a Windows Explorer and a removable disk appears as shown in Figure 10-5.



Figure 10-5 MSC Device on Windows 7 Explorer

When you open the removable disk, if it is the first time the MSC device is connected to the PC and is not formatted, Windows will ask to format it to handle files on the mass storage. When formatting, choose the File System you want. In embedded systems, the most widespread file system is the FAT.

If the mass storage device is a *volatile memory* such as a SDRAM, every time the target board is switched off, the data of the memory is lost, and so is the file system data information. Hence, the next time the target is switched on, the SDRAM is blank and reconnecting the mass storage to the PC, you will have to format again the mass storage device.

Once the device is correctly formatted, you are ready to test the MSC demo. Below are a few examples of what you can do:

- You can create one or more text files.
- You can write data in these files.
- You can open them to read the content of the files.
- You can copy/paste data.
- You can delete one or more files.

All of these actions will generate SCSI commands to write and read the mass storage device.

10-6 PORTING MSC TO A STORAGE LAYER

The storage layer port must implement the API functions summarized in Table 10-10. You can start by referencing to the storage port template located under:

```
Micrium\Software\uC-USB-Device-V4\Class\MSC\Storage\Template
```

Please refer to section E-3 “MSC Storage Layer Functions” on page 434 for a full listing of the storage layer API.

Function Name	Operation
USBD_StorageInit()	Initializes the storage medium.
USBD_StorageCapacityGet()	Gets the capacity of the storage medium
USBD_StorageRd()	Reads data from the storage medium
USBD_StorageWr()	Writes data to the storage medium
USBD_StorageStatusGet()	Gets the status of the storage medium. If the storage medium is a removable device such as an SD/MMC card, this function will return if the storage is inserted or removed.

Table 10-10 Storage API Functions

10-7 PORTING MSC TO A RTOS

The RTOS layer must implement the API functions listed in Table 10-11. You can start by referencing the RTOS port template located under:

`Micrium\Software\uc-USB-Device-V4\Class\MSC\OS\Template`

Please refer to section E-2 “MSC OS Functions” on page 428 for a full API description.

Function	Operation
USBD_MSC_OS_Init()	Initializes MSC OS interface. This function will create both signals (semaphores) for communication and enumeration processes. Furthermore, this function will create the MSC task used for the MSC protocol.
USBD_MSC_OS_CommSignalPost()	Posts a semaphore used for MSC communication,
USBD_MSC_OS_CommSignalPend()	Waits on a semaphore to become available for MSC communication.
USBD_MSC_OS_CommSignalDel()	Deletes a semaphore if no tasks are waiting for it for MSC communication.
USBD_MSC_OS_EnumSignalPost()	Posts a semaphore used for MSC enumeration process.
USBD_MSC_OS_EnumSignalPend()	Waits for a semaphore to become available for MSC enumeration process.

Table 10-11 RTOS API Functions

Personal Healthcare Device Class

This section describes the Personal Healthcare Device Class (PHDC) supported by μ C/USB-Device. The implementation offered refers to the following USB-IF specification:

- *USB Device Class Definition for Personal Healthcare Devices, release 1.0, Nov. 8 2007.*

PHDC allows you to build USB devices that are meant to be used to monitor and improve personal healthcare. Lots of modern personal healthcare devices have arrived on the market in recent years. Glucose meter, pulse oximeter and blood-pressure monitor are some examples. A characteristic of these devices is that they can be connected to a computer for playback, live monitoring or configuration. One of the typical ways to connect these devices to a computer is by using a USB connection, and that's why PHDC has been developed.

Although PHDC is a standard, most modern Operating Systems (OS) do not provide any specific driver for this class. When working with Microsoft Windows®, developers can use the WinUsb driver provided by Microsoft to create their own driver. The Continua Health Alliance also provides an example of a PHDC driver based on libusb (an open source USB library, for more information, see <http://www.libusb.org/>). This example driver is part of the Vendor Assisted Source-Code (VASC).

11-1 OVERVIEW

11-1-1 DATA CHARACTERISTICS

Personal healthcare devices, due to their nature, may need to send data in 3 different ways:

- Episodic: Data is sent sporadically each time user accomplishes a specific action.
- Store and forward: data is collected and stored on device while it is not connected. The data is then forwarded to the host once it is connected.
- Continuous: Data is sent continuously to the host for continuous monitoring.

Considering these needs, data transfers will be defined in terms of latency and reliability. PHDC defines three levels of reliability and four levels of latency:

- Reliability: Good, better and best.
- Latency: Very-high, high, medium and low.

For example, a device that sends continuous data for monitoring will send them as low latency and good reliability.

PHDC does not support all latency/reliability combinations. Here is a list of supported combinations:

- Low latency, good reliability.
- Medium latency, good reliability.
- Medium latency, better reliability.
- Medium latency, best reliability.
- High latency, best reliability.
- Very high latency, best reliability.

These combinations are called quality of service (QoS).

QoS (Latency / reliability)	Latency	Raw info rate	Transfer direction(s)	Typical use
Low / good	< 20ms	50 bits/sec to 1.2M bits/sec	IN	Real-time monitoring, with fast analog sampling rate.
Medium / good	< 200ms	50 bits/sec to 1.2M bits/s	IN	
Medium / better	< 200ms	10s of byte range	IN	Data from measured parameter collected off-line and replayed or sent real-time.
Medium / best	< 200ms	10s of byte range	IN, OUT	Events, notifications, request, control and status of physiological and equipment functionality.
High / best	< 2s	10s of byte range	IN, OUT	Physiological and equipment alarms.
Very high / best	< 20s	10s of byte range to gigabytes of data	IN, OUT	Transfer reports, histories or off-line collection of data.

Table 11-1 QoS Levels Description

11-1-2 OPERATIONAL MODEL

The requirements for data transfer QoS in personal healthcare devices can be accomplished by PHDC using bulk endpoints and, optionally, an interrupt endpoint. Table 11-2 and Figure 11-1 show the mapping between QoS and endpoint types.

Endpoint	Usage
Bulk OUT	All QoS host to device data transfers.
Bulk IN	Very high, high and medium latency device to host data transfers.
Interrupt IN	Low latency device to host data transfers.

Table 11-2 Endpoint - QoS Mapping

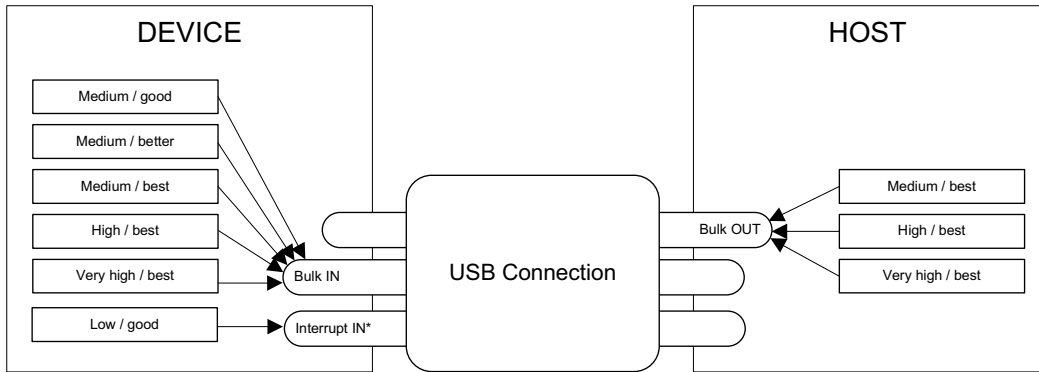

Figure 11-1 QoS - Endpoint Mapping

PHDC does not define a protocol for data and messaging. It is only intended to be used as a communication layer. Developers can use either data and messaging protocol defined in ISO/IEEE 11073-20601 base protocol or a vendor-defined protocol. Figure 11-2 shows the different software layers needed in a personal healthcare device.

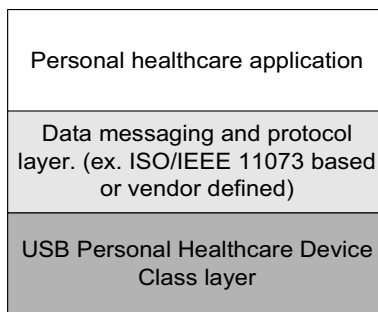

Figure 11-2 Personal Healthcare Device Software Layers

Since transfers having different QoS will have to share a single bulk endpoint, host and device need a way to inform each other what is the QoS of the current transfer. A metadata message preamble will then be sent before a single or a group of regular data transfers. This preamble will contain the information listed in Table 11-3.

Offset	Field	Size (bytes)	Description
0	aSignature	16	Constant used to verify preamble validity. Always set to "PhdcQoSSignature" string.
16	bNumTransfers	1	Count of following transfers to which QoS setting applies.
17	bQoSEncodingVersion	1	QoS information encoding version. Should be 0x01.
18	bmLatencyReliability	1	Bitmap that refers to latency / reliability bin for data.
19	bOpaqueDataSize	1	Length, in bytes, of opaque data.
20	bOpaqueData	[0 .. MaxPacketSize - 21]	Optional data usually application specific that is opaque to the class.

Table 11-3 Metadata Preamble

11-2 CONFIGURATION

11-2-1 GENERAL CONFIGURATION

Some constants are available to customize the class. These constants are located in the `usbd_cfg.h` file. Table 11-4 shows a description of each of them.

Constant	Description
<code>USBD_PHDC_CFG_MAX_NBR_DEV</code>	Configures the maximum number of class instances. Unless you plan having multiple configuration or interfaces using different class instances, this can be set to 1.
<code>USBD_PHDC_CFG_MAX_NBR_CFG</code>	Configures the maximum number of configuration in which PHDC is used. Keep in mind that if you use a high-speed device, two configurations will be built, one for full-speed and another for high-speed.
<code>USBD_PHDC_CFG_DATA_OPAQUE_MAX_LEN</code>	Maximum length in octets that opaque data can be. Must always be equal or less to <code>MaxPacketSize - 21</code> .

Constant	Description
USBD_PHDC_OS_CFG_SCHED_EN	<p>If using μC/OS-II or μC/OS-III RTOS port, enable or disable the scheduler feature. You should set it to <code>DEF_DISABLED</code> if device only use one QoS level to send data, for instance. (See section 11-4 “RTOS QoS-based scheduler” on page 196)</p> <p>WARNING: If you set this constant to <code>DEF_ENABLED</code>, you MUST ensure that the scheduler’s task has a lower priority (i.e. higher priority value) than any task that can write PHDC data.</p>

Table 11-4 Configuration Constants Summary

If you set `USBD_PHDC_OS_CFG_SCHED_EN` to `DEF_ENABLED` and you use a μ C/OS-II or μ C/OS-III RTOS port, PHDC will need an internal task for the scheduling operations. There are two application specific configurations that must be set in this case. They should be defined in the `app_cfg.h` file. Table 11-5 describes these configurations.

Constant	Description
USBD_PHDC_OS_CFG_SCHED_TASK_PRIO	<p>QoS based scheduler’s task priority.</p> <p>WARNING: You <i>must</i> ensure that the scheduler’s task has a lower priority (i.e. higher priority value) than any task writing PHDC data.</p>
USBD_PHDC_OS_CFG_SCHED_TASK_STK_SIZE	QoS based scheduler’s task stack size. Default value is 512.

Table 11-5 Application-Specific Configuration Constants

11-2-2 CLASS INSTANCE CONFIGURATION

Before starting the communication phase, your application needs to initialize and configure the class to suit its needs. Table 11-6 summarizes the initialization functions provided by the PHDC implementation. For a complete API reference, see section F-1 “PHDC Functions” on page 442.

Function name	Operation
USBD_PHDC_Init()	Initializes PHDC internal structures and variables.
USBD_PHDC_Add()	Adds a new instance of PHDC.
USBD_PHDC_RdCfg()	Configures read communication pipe parameters.
USBD_PHDC_WrCfg()	Configures write communication pipe parameters.
USBD_PHDC_11073_ExtCfg()	Configures 11073 function extension(s).
USBD_PHDC_CfgAdd()	Adds PHDC instance into USB device configuration.

Table 11-6 PHDC Initialization API Summary

You need to follow these steps to successfully initialize PHDC:

1 Call `USBD_PHDC_Init()`

This is the first function you should call, and you should do it only once, even if you use multiple class instances. This function will initialize all internal structures and variables that the class will need. It will also initialize the real-time operating system (RTOS) layer.

2 Call `USBD_PHDC_Add()`

This function will allocate a PHDC instance. This call will also let you determine if the PHDC instance is capable of sending / receiving metadata message preamble and if it uses vendor defined or ISO/IEEE 11073 based data and messaging protocol.

Another parameter of this function lets you specify a callback function that the class will call when host enables / disables metadata message preambles. This is useful for the application as the behavior in communication will differ depending on the metadata message preamble state.

If your application needs to send low latency / good reliability data, the class will need to allocate an interrupt endpoint. The interval of the endpoint will be specified in this call as well.

- 3 Call `USBD_PHDC_RdCfg()` and `USBD_PHDC_WrCfg()`

The next step is to call `USBD_PHDC_RdCfg()` and `USBD_PHDC_WrCfg()`. These functions will let you set the latency / reliability bins that the communication pipe will carry. Bins are listed in Table 11-7. It will also be used to specify opaque data to send within extra endpoint metadata descriptor (see “USB Device Class Definition for Personal Healthcare Devices”, Release 1.0, Section 5 for more details on PHDC extra descriptors)..

Name	Description
<code>USBD_PHDC_LATENCY_VERYHIGH_RELY_BEST</code>	Very-high latency, best reliability.
<code>USBD_PHDC_LATENCY_HIGH_RELY_BEST</code>	High latency, best reliability.
<code>USBD_PHDC_LATENCY_MEDIUM_RELY_BEST</code>	Medium latency, best reliability.
<code>USBD_PHDC_LATENCY_MEDIUM_RELY_BETTER</code>	Medium latency, better reliability.
<code>USBD_PHDC_LATENCY_MEDIUM_RELY_GOOD</code>	Medium latency, good reliability.
<code>USBD_PHDC_LATENCY_LOW_RELY_GOOD</code>	Low latency, good reliability.

Table 11-7 Listing of QoS Bins

- 4 Call `USBD_PHDC_11073_ExtCfg()` (optional)

If PHDC instance uses ISO/IEEE 11073 based data and messaging protocol, a call to this function will let you configure the device specialization code(s).

- 5 Call `USBD_PHDC_CfgAdd()`

Finally, once the class instance is correctly configured and initialized, you will need to add it to a USB configuration. This is done by calling `USBD_PHDC_CfgAdd()`.

Listing 11-1 shows an example of initialization and configuration of a PHDC instance. If you need more than one class instance of PHDC for your application, refer to section 7-1 “Class Instance Concept” on page 99 for generic examples of how to build your device.

```

CPU_BOOLEAN App_USBD_PHDC_Init(CPU_INT08U dev_nbr,
                               CPU_INT08U cfg_hs,
                               CPU_INT08U cfg_fs)
{
    USBD_ERR    err;
    CPU_INT08U  class_nbr;

    USBD_PHDC_Init(&err);                (1)
    class_nbr = USBD_PHDC_Add(DEF_YES,    (2)
                             DEF_YES,
                             App_USBD_PHDC_SetPreambleEn,
                             10,
                             &err);

    latency_rely_flags = USBD_PHDC_LATENCY_VERYHIGH_RELY_BEST |
                         USBD_PHDC_LATENCY_HIGH_RELY_BEST    |
                         USBD_PHDC_LATENCY_MEDIUM_RELY_BEST;
    USBD_PHDC_RdCfg(class_nbr,           (3)
                    latency_rely_flags,
                    opaque_data_rx,
                    sizeof(opaque_data_rx),
                    &err);
    USBD_PHDC_WrCfg(class_nbr,           (3)
                    USBD_PHDC_LATENCY_VERYHIGH_RELY_BEST,
                    opaque_data_tx,
                    sizeof(opaque_data_tx),
                    &err);

    USBD_PHDC_11073_ExtCfg(class_nbr, dev_specialization, 1, &err);    (4)
    valid_cfg_hs = USBD_PHDC_CfgAdd(class_nbr, dev_nbr, cfg_hs, &err);    (5)
    valid_cfg_fs = USBD_PHDC_CfgAdd(class_nbr, dev_nbr, cfg_fs, &err);    (6)
}

```

Listing 11-1 PHDC Instance Initialization and Configuration Example

L11-1(1) Initialize PHDC internal members and variables.

L11-1(2) Create a PHDC instance, this instance support preambles and ISO/IEEE 11073 based data and messaging protocol.

-
- L11-1(3) Configure read and write pipes with correct QoS and opaque data.
 - L11-1(4) Add ISO/IEEE 11073 device specialization to PHDC instance.
 - L11-1(5) Add class instance to high-speed configuration.
 - L11-1(6) Add class instance to full-speed configuration.

11-3 CLASS INSTANCE COMMUNICATION

Now that the class instance has been correctly initialized, it's time to exchange data. PHDC offers 4 functions for that. Table 11-8 summarizes the communication functions provided by the PHDC implementation. See Appendix F, "PHDC API Reference" on page 441 for a complete API reference.

Function name	Operation
USBD_PHDC_RdPreamble()	Reads metadata preamble.
USBD_PHDC_Rd()	Reads PHDC data.
USBD_PHDC_WrPreamble()	Writes metadata preamble.
USBD_PHDC_Wr()	Writes PHDC data.

Table 11-8 PHDC Communication API Summary

11-3-1 COMMUNICATION WITH METADATA PREAMBLE

Via the preamble enabled callback, the application will be notified once host enables metadata preamble. If metadata preambles are enabled, you should use the following procedure to perform a read:

- Call `USBD_PHDC_RdPreamble()`. Device expects metadata preamble from the host. This function will return opaque data and the number of incoming transfers that the host specified. Note that if the host disables preamble while the application is pending on that function, it will immediately return with error "`USBD_ERR_OS_ABORT`".

- Call `USBD_PHDC_Rd()` a number of times corresponding to the number of incoming transfers returned by `USBD_PHDC_RdPreamble()`. Application must ensure that the buffer provided to the function is large enough to accommodate all the data. Otherwise, synchronization issues might happen. Note that if the host enables preamble while the application is pending on that function, it will immediately return with error “`USBD_ERR_OS_ABORT`”.

```

CPU_INT16U App_USBD_PHDC_Rd(CPU_INT08U class_nbr,
                             CPU_INT08U *p_data_opaque_buf,
                             CPU_INT08U *p_data_opaque_len,
                             CPU_INT08U *p_buf,
                             USBD_ERR *p_err)
{
    CPU_INT08U nbr_xfer;
    CPU_INT16U xfer_len;

    *p_data_opaque_len = USBD_PHDC_RdPreamble(      class_nbr,           (1)
                                                                (void *)p_data_opaque_buf,    (2)
                                                                USBD_PHDC_CFG_DATA_OPAQUE_MAX_LEN,
                                                                &nbr_xfer,                    (3)
                                                                0,                            (4)
                                                                p_err);

    for (i = 0; i < nbr_xfers; i++) {              (5)
        xfer_len = USBD_PHDC_Rd(                    class_nbr,           (6)
                                                                (void *)p_buf,
                                                                APP_USBD_PHDC_ITEM_DATA_LEN_MAX,
                                                                0,                            (4)
                                                                p_err);

        /* Handle received data. */
    }

    return (xfer_len);
}

```

Listing 11-2 PHDC Read Procedure

- L11-2(1) The class instance number obtained with `USBD_PHDC_Add()` will serve internally to the PHDC class to route the data to the proper endpoints.

- L11-2(2) Buffer that will contain opaque data. Application must ensure that the buffer provided is large enough to accommodate all the data. Otherwise, synchronization issues might happen.
- L11-2(3) Variable that will contain the number of following transfers to which this preamble applies.
- L11-2(4) In order to avoid infinite blocking situation, a timeout expressed in milliseconds can be specified. A value of '0' makes the application task wait forever.
- L11-2(5) Read all the USB transfers to which the preamble applies.
- L11-2(6) Buffer that will contain the data. Application must ensure that the buffer provided is large enough to accommodate all the data. Otherwise, synchronization issues might happen.

You should use the following procedure to perform a write:

- Call `USBD_PHDC_WrPreamble()`. Host expects metadata preamble from the device. Application will have to specify opaque data, transfer's QoS (see Table 11-7), and a number of following transfers to which the selected QoS applies.
- Call `USBD_PHDC_Wr()` a number of times corresponding to the number of transfers following the preamble.

```
CPU_INT16U App_USBD_PHDC_Wr(CPU_INT08U      class_nbr,
                             LATENCY_RELY_FLAGS latency_rely,
                             CPU_INT08U      nbr_xfer,
                             CPU_INT08U      *p_data_opaque_buf
                             CPU_INT08U      data_opaque_buf_len,
                             CPU_INT08U      *p_buf,
                             CPU_INT08U      buf_len,
                             USBD_ERR       *p_err)
```

```

{
(void)USBDC_PHDC_WrPreamble(      class_nbr,          (1)
                                (void *)p_data_opaque_buf, (2)
                                data_opaque_buf_len,
                                latency_rely,          (3)
                                nbr_xfer,              (4)
                                0,                    (5)
                                p_err);

for (i = 0; i < nbr_xfer; i++) { (6)
/* Prepare data to send. */

xfer_len = USBDC_PHDC_Wr(      class_nbr,          (1)
                              (void *)p_buf,          (7)
                              buf_len,
                              latency_rely,          (3)
                              0,
                              p_err);
}
}

```

Listing 11-3 PHDC Write Procedure

- L11-3(1) The class instance number obtained with `USBDC_PHDC_Add()` will serve internally to the PHDC class to route the data to the proper endpoints.
- L11-3(2) Buffer that contains opaque data.
- L11-3(3) Latency / reliability (QoS) of the following transfer(s).
- L11-3(4) Variable that contains the number of following transfers to which this preamble will apply.
- L11-3(5) In order to avoid infinite blocking situation, a timeout expressed in milliseconds can be specified. A value of '0' makes the application task wait forever.
- L11-3(6) Write all the USB transfers to which the preamble will apply.
- L11-3(7) Buffer that contains the data.

11-3-2 COMMUNICATION WITHOUT METADATA PREAMBLE

If device does not support metadata preamble or if it supports them but it has not been enabled by the host, you should not call `USBD_PHDC_RdPreamble()` and `USBD_PHDC_WrPreamble()`.

11-4 RTOS QoS-BASED SCHEDULER

Since it is possible to send data with different QoS using a single bulk endpoint, you might want to prioritize the transfers by their QoS latency (medium latency transfers processed before high latency transfers, for instance). This kind of prioritization is implemented inside PHDC μ C/OS-II and μ C/OS-III RTOS layer. Table 11-9 shows the priority value associated with each QoS latency (the lowest priority value will be treated first).

QoS latency	QoS based scheduler associated priority
Very high latency	3
High latency	2
Medium latency	1

Table 11-9 QoS Based Scheduler Priority Values

For instance, let's say that your application has 3 tasks. Task A has an OS priority of 1, task B has an OS priority of 2 and task C has an OS priority of 3. Note that a low priority number indicates a high priority task. Now say that all 3 tasks want to write PHDC data of different QoS latency. Task A wants to write data that can have very high latency, task B wants to write data that can have medium latency, and finally, task C wants to write data that can have high latency. Table 11-10 shows a summary of the tasks involved in this example.

Task	QoS latency of data to write	OS priority	QoS priority of data to write
A	Very high	1	3
B	Medium	2	1
C	High	3	2

Table 11-10 QoS-Based Scheduling Example

If no QoS based priority management is implemented, the OS will then resume the tasks in the order of their OS priority. In this example, the task that has the higher OS priority, A, will be resumed first. However, that task wants to write data that can have very high latency (QoS priority of 3). A better choice would be to resume task B first, which wants to send data that can have medium latency (QoS priority of 1). Figure 11-3 and Figure 11-4 represent this example without and with a QoS-based scheduler, respectively.



Figure 11-3 Task Execution Order, Without QoS Based Scheduling



Figure 11-4 Task Execution Order, with QoS Based Scheduling

F11-4(1)

F11-4(2)

F11-4(3) A task currently holds the lock on the write bulk endpoint, task A, B and C are added to the wait list until the lock is released.

- F11-4(4) The lock has been released. The QoS based scheduler's task is resumed, and finds the task that should be resumed first (according to the QoS of the data it wants to send). Task B is resumed.
- F11-4(5) Task B completes its execution and releases the lock on the pipe. This resumes the scheduler's task.
- F11-4(6) Again, the QoS based scheduler finds the next task that should be resumed. Task C is resumed.
- F11-4(7) Task C has completed its execution and releases the lock. Scheduler task is resumed and determines that task A is the next one to be resumed.

The QoS-based scheduler is implemented in the RTOS layer. Three functions are involved in the execution of the scheduler.

Function name	Called by	Operation
USBD_PHDC_OS_WrBulkLock()	USBD_PHDC_Wr() or USBD_PHDC_WrPreamble(), depending if preambles are enabled or not.	Locks write bulk pipe.
USBD_PHDC_OS_WrBulkUnlock()	USBD_PHDC_Wr() .	Unlocks write bulk pipe.
USBD_PHDC_OS_WrBulkSchedTask()	N/A.	Determines next task to resume.

Table 11-11 QoS-Based Scheduler API Summary

Pseudocode for these three functions are shown in Listing 11-4, Listing 11-5 and Listing 11-6.

```
void USBD_PHDC_OS_WrBulkLock (CPU_INT08U  class_nbr,
                              CPU_INT08U  prio,
                              CPU_INT16U  timeout_ms,
                              USBD_ERR    *p_err)
{
    Increment transfer count of given priority (QoS);
    Post scheduler lock semaphore;
    Pend on priority specific semaphore;
    Decrement transfer count of given priority (QoS);
}
```

Listing 11-4 Pseudocode of USBD_PHDC_OS_WrBulkLock()

```
void USBD_PHDC_OS_WrBulkUnlock (CPU_INT08U  class_nbr)
{
    Post scheduler release semaphore;
}
```

Listing 11-5 Pseudocode of USBD_PHDC_OS_WrBulkUnlock()

```
static void USBD_PHDC_OS_WrBulkSchedTask (void *p_arg)
{
    Pend on scheduler lock semaphore;

    Get next highest QoS ready;
    PostSem(SemList[QoS]);

    Pend on scheduler release semaphore;
}
```

Listing 11-6 Pseudocode of QoS-Based Scheduler's Task

11-5 USING THE DEMO APPLICATION

Micrium provides a demo application that lets you test and evaluate the class implementation. Source files are provided for the device (for μ C/OS-II and μ C/OS-III only). Executable and source files are provided for the host (Windows only).

11-5-1 SETUP THE APPLICATION

On the target side, two applications are available: `app_usbd_phdc_single.c` and `app_usbd_phdc_multiple.c`. You should compile only one of these files with your project. Table 11-12 provide a description of each one. Both files are located in the following folders:

```
\Micrium\Software\uC-USB-Device-V4\App\Device\OS\uCOS-II
\Micrium\Software\uC-USB-Device-V4\App\Device\OS\uCOS-III
```

File	Description
<code>app_usbd_phdc_single.c</code>	Only one task is used to send all data of different QoS. Usually used with <code>USBD_PHDC_OS_CFG_SCHED_EN</code> set to <code>DEF_DISABLED</code> .
<code>app_usbd_phdc_multiple.c</code>	One task per QoS level is used to send data. Usually used with <code>USBD_PHDC_OS_CFG_SCHED_EN</code> set to <code>DEF_ENABLED</code> .

Table 11-12 Device Demo Application Files

Several constants are available to customize the demo application on both device and host (Windows) side. Table 11-13 describe device side constants that are located in the `app_cfg.h` file. Table 11-14 describe host side constants that are located in the `app_phdc.c` file.

Constant	Description
<code>APP_CFG_USBD_PHDC_EN</code>	Set to <code>DEF_ENABLED</code> to enable the demo application.
<code>APP_CFG_USBD_PHDC_TX_COMM_TASK_PRIO</code>	Priority of the write task.
<code>APP_CFG_USBD_PHDC_RX_COMM_TASK_PRIO</code>	Priority of the read task.
<code>APP_CFG_USBD_PHDC_TASK_STK_SIZE</code>	Stack size of both read and write tasks. Default value is 512.
<code>APP_CFG_USBD_PHDC_ITEM_DATA_LEN_MAX</code>	Set this constant to the maximum number of bytes that can be transferred as data. Must be ≥ 5 .
<code>APP_CFG_USBD_PHDC_ITEM_NBR_MAX</code>	Set this constant to the maximum number of items that the application should support. Must be ≥ 1 .

Table 11-13 Device Side Demo Application's Configuration Constants

Constant	Description
APP_ITEM_DATA_LEN_MAX	Set this constant to the maximum number of bytes that can be transferred as data. Must be ≥ 5 .
APP_ITEM_DATA_OPAQUE_LEN_MAX	Set this constant to the maximum number of bytes that can be transferred as opaque data. Must be $\leq (MaxPacketSize - 21)$.
APP_ITEM_NBR_MAX	Set this constant to the maximum number of items that the application should support. Must be ≥ 1 .
APP_STAT_COMP_PERIOD	Set this constant to the period (in ms) on which the statistic of each transfer (mean and standard deviation) should be computed.
APP_ITEM_PERIOD_MIN	Set this constant to the minimum period (in ms) that a user can specify for an item.
APP_ITEM_PERIOD_MAX	Set this constant to the maximum period (in ms) that a user can specify for an item.
APP_ITEM_PERIOD_MULTIPLE	Set this constant to a multiple (in ms) that periodicity of items specified by the user must comply.

Table 11-14 Host Side (Windows) Demo Application's Configuration Constants

Since Microsoft does not provide any specific driver for PHDC, you will have to indicate to windows which driver to load using an “inf” file. The “inf” file will ask Windows to load the WinUSB generic driver (provided by Microsoft). The application uses the USBDev_API, which is a wrapper of the WinUSB driver (refer to section 12-3 “USBDev_API” on page 214).

Windows will ask for the INF file (refer to section 3-1-1 “About INF Files” on page 46) the first time the device will be plugged-in. It is located in the following folder:

```
\Micrium\Software\uC-USB-Device-V4\App\Host\OS\Windows\PHDC\INF
```

Once the driver is successfully loaded, the Windows host application is ready to be launched. The executable is located in the following folder:

```
\Micrium\Software\uC-USB-Device-V4\App\Host\OS\Windows\PHDC\Visual Studio 2010\exe
```

11-5-2 RUNNING THE DEMO APPLICATION

In this demo application, you can ask the device to continuously send data of different QoS level and using a given periodicity. Each requested transfer is called an “item”. Using the monitor, you can see each transfer’s average periodicity and standard deviation. The monitor will also show the data and opaque data that you specified. At startup, the application will always send a default item with a periodicity of 100 ms. This item will send the device CPU usage and the value of a counter that is incremented each time the item is sent. The default item uses low latency / good reliability as QoS. Figure 11-5 shows the demo application at startup.



```

CAPHDC.exe
*****
PHDC MONITOR
Items Latency /Reliability Period Mean Std Dev Opaque data/data
Dflt Low/Good 100 100 0 Counter: 949
CPU: 1%
*****
Bus usage: 0.001%
Press '1' to add a new item
Press '2' to exit

```

Figure 11-5 Demo Application at Startup

At this point, you have the possibility to add a new item by pressing 1. You will be prompted to specify the following values:

- Periodicity of the transfer
- QoS (Latency / reliability) of the transfer
- Opaque data (if QoS is not low latency / good reliability)
- Data

Figure 11-6 shows the demo application with a few items added.



```

C:\PHDC.exe
*****
PHDC MONITOR
*****
Items  Latency /Reliability  Period  Mean  Std Dev  Opaque data/data
      <ms>  <ms>      <ms>  <ms>  <ms>      <bytes>
Dflt   Low/Good             100    100     0      Counter: 2074
                               CPU:      4%

 1     Low/Good              10     10      0      Low latency data
 2     Medium/Good          100    100     0      Item 2 / Medium latency data
 3     Medium/Better       100    100     0      Item 3 / Medium latency data
 4     Medium/Best         100    100     0      Item 4 / Medium latency data
 5     High/Best           1000   1001    0      Item 5 / High latency data
 6     Very high/Best      4000   4006    0      Item 6 / Very high latency data
*****
Bus usage: 0.025%
*****
Press '1' to add a new item
Press '2' to exit

```

Figure 11-6 Demo Application with five Items Added

11-6 PORTING PHDC TO A RTOS

Since PHDC communication functions can be called from different tasks at application level, there is a need to protect the resources they use (in this case, the endpoint). Furthermore, since it is possible to send data with different QoS using a single bulk endpoint, an application might want to prioritize the transfers by their QoS (i.e. medium latency transfers processed before high latency transfers). This kind of prioritization can be implemented/customized inside the RTOS layer (see Section 11-4, “RTOS QoS-based scheduler” on page 196, for more information). By default, Micrium will provide an RTOS layer for both $\mu\text{C}/\text{OS-II}$ and $\mu\text{C}/\text{OS-III}$. However, it is possible to create your own RTOS layer. Your layer will need to implement the functions listed in Table 11-15. For a complete API description, see Appendix F, “PHDC API Reference” on page 441.

Function name	Operation
USBD_PHDC_OS_Init()	Initializes all internal members / tasks.
USBD_PHDC_OS_RdLock()	Locks read pipe.
USBD_PHDC_OS_RdUnlock()	Unlocks read pipe.
USBD_PHDC_OS_WrBulkLock()	Locks write bulk pipe.
USBD_PHDC_OS_WrBulkUnlock()	Unlocks write bulk pipe.
USBD_PHDC_OS_WrIntrLock()	Locks write interrupt pipe.
USBD_PHDC_OS_WrIntrUnlock()	Unlocks write interrupt pipe.
USBD_PHDC_OS_Reset()	Resets OS layer members.

Table 11-15 OS Layer API Summary

Chapter

12

Vendor Class

The Vendor class allows you to build vendor-specific devices implementing for instance a proprietary protocol. It relies on a pair of bulk endpoints to transfer data between the host and the device. Bulk transfers are typically convenient for transferring large amounts of unstructured data and provides reliable exchange of data by using an error detection and retry mechanism. Besides bulk endpoints, an optional pair of interrupt endpoints can also be used. Any operating system (OS) can work with the Vendor class provided that the OS has a driver to handle the Vendor class. Depending on the OS, the driver can be native or vendor-specific. For instance, under Microsoft Windows[®], your application interacts with the WinUSB driver provided by Microsoft to communicate with the vendor device.

12-1 OVERVIEW

Figure 12-1 shows the general architecture between the host and the device using the Vendor class. In this example, the host operating system is Windows.



Figure 12-1 **General Architecture Between Windows Host and Vendor Class**

On the Windows side, the application communicates with the vendor device by interacting with the USBDev_API library. This library provided by Micrium offers an API to manage a device and its associated pipes, and to communicate with the device through control, bulk and interrupt endpoints. USBDev_API is a wrapper that allows the use of the WinUSB functions exposed by Winusb.dll.

On the device side, the Vendor class is composed of the following endpoints:

- A pair of control IN and OUT endpoints called the default endpoint.
- A pair of bulk IN and OUT endpoints.
- A pair of interrupt IN and OUT endpoints. This pair is optional.

Table 12-1 indicates the usage of the different endpoints:

Endpoint	Direction	Usage
Control IN Control OUT	Device-to-host Host-to-device	Standard requests for enumeration and vendor-specific requests.
Bulk IN Bulk OUT	Device-to-host Host-to-device	Raw data communication. Data can be structured according to a proprietary protocol.
Interrupt IN Interrupt OUT	Device-to-host Host-to-device	Raw data communication or notification. Data can be structured according to a proprietary protocol.

Table 12-1 **Vendor Class Endpoints Usage**

The device application can use bulk and interrupt endpoints to send or receive data to or from the host. It can only use the default endpoint to decode vendor-specific requests sent by the host. The standard requests are managed internally by the Core layer of μ C/USB-Device.

12-2 CONFIGURATION

12-2-1 GENERAL CONFIGURATION

Some constants are available to customize the class. These constants are located in the USB device configuration file, `usbd_cfg.h`. Table 12-2 shows their description.

Constant	Description
<code>USBD_VENDOR_CFG_MAX_NBR_DEV</code>	Configures the maximum number of class instances. Unless you plan on having multiple configurations or interfaces using different class instances, this can be set to 1.
<code>USBD_VENDOR_CFG_MAX_NBR_CFG</code>	Configures the maximum number of configuration in which Vendor class is used. Keep in mind that if you use a high-speed device, two configurations will be built, one for full-speed and another for high-speed.

Table 12-2 **General Configuration Constants Summary**

12-2-2 CLASS INSTANCE CONFIGURATION

Before starting the communication phase, your application needs to initialize and configure the class to suit its needs. Table 12-3 summarizes the initialization functions provided by the Vendor class. For more details about the functions parameters, refer to section G-1 “Vendor Class Functions” on page 474.

Function name	Operation
USBD_Vendor_Init()	Initializes Vendor class internal structures and variables.
USBD_Vendor_Add()	Creates a new instance of Vendor class.
USBD_Vendor_CfgAdd()	Adds Vendor instance to the specified device configuration.

Table 12-3 Vendor Class Initialization API Summary

You need to call these functions in the order shown below to successfully initialize the Vendor class:

1 Call `USBD_Vendor_Init()`

This is the first function you should call and you should do it only once even if you use multiple class instances. This function initializes all internal structures and variables that the class needs.

2 Call `USBD_Vendor_Add()`

This function allocates a Vendor class instance. This function allows you to include a pair of interrupt endpoints for the considered class instance. If the interrupt endpoints are included, the polling interval can also be indicated. The polling interval will be the same for interrupt IN and OUT endpoints. Moreover, another parameter lets you specify a callback function used when receiving vendor requests. This callback allows the decoding of vendor-specific requests utilized by a proprietary protocol.

3 Call `USBD_Vendor_CfgAdd()`

Finally, once the Vendor class instance has been created, you must add it to a specific configuration.

Listing 12-1 illustrates the use of the previous functions for initializing the Vendor class.

```

static CPU_BOOLEAN App_USBD_Vendor_VendorReq (          CPU_INT08U   class_nbr,
                                                    const  USBD_SETUP_REQ *p_setup_req);

CPU_BOOLEAN App_USBD_Vendor_Init (CPU_INT08U dev_nbr,
                                  CPU_INT08U cfg_hs,
                                  CPU_INT08U cfg_fs)
{
    USBD_ERR    err;
    CPU_INT08U  class_nbr;

    USBD_Vendor_Init(&err);
    if (err != USBD_ERR_NONE) {
        /* $$$$ Handle the error. */
    }

    class_nbr = USBD_Vendor_Add(DEF_FALSE,
                                0u,
                                App_USBD_Vendor_VendorReq,
                                &err);
    if (err != USBD_ERR_NONE) {
        /* $$$$ Handle the error. */
    }

    if (cfg_hs != USBD_CFG_NBR_NONE) {
        USBD_Vendor_CfgAdd(class_nbr, dev_nbr, cfg_hs, &err);
        if (err != USBD_ERR_NONE) {
            /* $$$$ Handle the error. */
        }
    }

    if (cfg_fs != USBD_CFG_NBR_NONE) {
        USBD_Vendor_CfgAdd(class_nbr, dev_nbr, cfg_fs, &err);
        if (err != USBD_ERR_NONE) {
            /* $$$$ Handle the error. */
        }
    }
}

```

Listing 12-1 **Vendor Class Initialization Example**

L12-1(1) Provide an application callback for vendor requests decoding.

L12-1(2) Initialize Vendor internal structures, variables.

-
- L12-1(3) Create a new Vendor class instance. In this example, **DEF_FALSE** indicates that no interrupt endpoints are used. Hence, the polling interval is set to 0. The callback `App_USBD_Vendor_VendorReq()` is passed to the function.
- L12-1(4) Check if the high-speed configuration is active and proceed to add the Vendor instance previously created to this configuration.
- L12-1(5) Check if the full-speed configuration is active and proceed to add the Vendor instance to this configuration.

Code Listing 12-1 also illustrates an example of multiple configurations. The functions `USBD_Vendor_Add()` and `USBD_Vendor_CfgAdd()` allow you to create multiple configurations and multiples instances architecture. Refer to section 7-1 “Class Instance Concept” on page 99 for more details about multiple class instances.

12-2-3 CLASS INSTANCE COMMUNICATION

The Vendor class offers the following functions to communicate with the host. For more details about the functions parameters, refer to section G-1 “Vendor Class Functions” on page 474.

Function name	Operation
<code>USBD_Vendor_Rd()</code>	Receive data from host through bulk OUT endpoint. This function is blocking.
<code>USBD_Vendor_Wr()</code>	Send data to host through bulk IN endpoint. This function is blocking.
<code>USBD_Vendor_RdAsync()</code>	Receive data from host through bulk OUT endpoint. This function is non-blocking.
<code>USBD_Vendor_WrAsync()</code>	Send data to host through bulk IN endpoint. This function is non-blocking.
<code>USBD_Vendor_IntrRd()</code>	Receive data from host through interrupt OUT endpoint. This function is blocking.
<code>USBD_Vendor_IntrWr()</code>	Sends data to host through interrupt IN endpoint. This function is blocking.
<code>USBD_Vendor_IntrRdAsync()</code>	Receives data from host through interrupt OUT endpoint. This function is non-blocking.
<code>USBD_Vendor_IntrWrAsync()</code>	Sends data to host through interrupt IN endpoint. This function is non-blocking.

Table 12-4 Vendor Communication API Summary

12-2-4 SYNCHRONOUS COMMUNICATION

Synchronous communication means that the transfer is blocking. Upon function call, the applications blocks until the transfer completion with or without an error. A timeout can be specified to avoid waiting forever.

Listing 12-2 presents a read and write example to receive data from the host using the bulk OUT endpoint and to send data to the host using the bulk IN endpoint.

```

CPU_INT08U  rx_buf[2];
CPU_INT08U  tx_buf[2];
USBD_ERR    err;

(void)USBD_Vendor_Rd(      class_nbr,          (1)
                        (void *)&rx_buf[0],   (2)
                        2u,
                        0u,                    (3)
                        &err);
if (err != USBD_ERR_NONE) {
    /* $$$ Handle the error. */
}

(void)USBD_Vendor_Wr(      class_nbr,          (1)
                        (void *)&tx_buf[0],   (4)
                        2u,
                        0u,                    (3)
                        DEF_FALSE,            (5)
                        &err);
if (err != USBD_ERR_NONE) {
    /* $$$ Handle the error. */
}

```

Listing 12-2 Synchronous Bulk Read and Write Example

- L12-2(1) The class instance number created with `USBD_Vendor_Add()` will serve internally to the Vendor class to route the transfer to the proper bulk OUT or IN endpoint.
- L12-2(2) Application must ensure that the buffer provided to the function is large enough to accommodate all the data. Otherwise, synchronization issues might happen.
- L12-2(3) In order to avoid an infinite blocking situation, a timeout expressed in milliseconds can be specified. A value of '0' makes the application task wait forever.

L12-2(4) Application provides the initialized transmit buffer.

L12-2(5) If this flag is set to `DEF_TRUE` and the transfer length is multiple of the endpoint maximum packet size, the device stack will send a zero-length packet to the host to signal the end of transfer.

The use of interrupt endpoint communication functions, `USBD_Vendor_IntrRd()` and `USBD_Vendor_IntrWr()`, is similar to bulk endpoint communication functions presented in Listing 12-2.

12-2-5 ASYNCHRONOUS COMMUNICATION

Asynchronous communication means that the transfer is non-blocking. Upon function call, the application passes the transfer information to the device stack and does not block. Other application processing can be done while the transfer is in progress over the USB bus. Once the transfer has completed, a callback is called by the device stack to inform the application about the transfer completion. Listing 12-3 shows an example of asynchronous read and write.

```

void App_USBD_Vendor_Comm (CPU_INT08U class_nbr)
{
    CPU_INT08U rx_buf[2];
    CPU_INT08U tx_buf[2];
    USBD_ERR err;

    USBD_Vendor_RdAsync(          class_nbr,          (1)
                               (void *)&rx_buf[0],  (2)
                               2u,
                               App_USBD_Vendor_RxCmpl, (3)
                               (void *) 0u,          (4)
                               &err);
    if (err != USBD_ERR_NONE) {
        /* $$$$ Handle the error. */
    }

    USBD_Vendor_WrAsync(          class_nbr,          (1)
                          (void *)&tx_buf[0],      (5)
                          2u,
                          App_USBD_Vendor_TxCmpl,  (3)
                          (void *) 0u,            (4)
                          DEF_FALSE,              (6)
                          &err);
}

```

```

    if (err != USBD_ERR_NONE) {
        /* $$$$ Handle the error. */
    }
}

static void App_USBD_Vendor_RxCmpl (CPU_INT08U class_nbr,
                                     void *p_buf,
                                     CPU_INT32U buf_len,
                                     CPU_INT32U xfer_len,
                                     void *p_callback_arg,
                                     USBD_ERR err)
(3)
{
    (void)class_nbr;
    (void)p_buf;
    (void)buf_len;
    (void)xfer_len;
    (void)p_callback_arg;
(4)

    if (err == USBD_ERR_NONE) {
        /* $$$$ Do some processing. */
    } else {
        /* $$$$ Handle the error. */
    }
}

static void App_USBD_Vendor_TxCmpl (CPU_INT08U class_nbr,
                                     void *p_buf,
                                     CPU_INT32U buf_len,
                                     CPU_INT32U xfer_len,
                                     void *p_callback_arg,
                                     USBD_ERR err)
(3)
{
    (void)class_nbr;
    (void)p_buf;
    (void)buf_len;
    (void)xfer_len;
    (void)p_callback_arg;
(4)
    if (err == USBD_ERR_NONE) {
        /* $$$$ Do some processing. */
    } else {
        /* $$$$ Handle the error. */
    }
}
}

```

Listing 12-3 Asynchronous Bulk Read and Write Example

- L12-3(1) The class instance number serves internally to the Vendor class to route the transfer to the proper bulk OUT or IN endpoint.
- L12-3(2) Application must ensure that the buffer provided to the function is large enough to accommodate all the data. Otherwise, synchronization issues might happen.
- L12-3(3) The application provides a callback passed as a parameter. Upon completion of the transfer, the device stack calls this callback so that the application can finalize the transfer by analyzing the transfer result. For instance, upon read operation completion, the application may do a certain processing with the received data. Upon write completion, the application may indicate if the write was successful and how many bytes were sent.
- L12-3(4) An argument associated to the callback can be also passed. Then in the callback context, some private information can be retrieved.
- L12-3(5) Application provides the initialized transmit buffer.
- L12-3(6) If this flag is set to `DEF_TRUE` and the transfer length is a multiple of the endpoint maximum packet size, the device stack will send a zero-length packet to the host to signal the end of transfer.

The use of interrupt endpoint communication functions, `USBD_Vendor_IntrRdAsync()` and `USBD_Vendor_IntrWrAsync()`, is similar to bulk endpoint communication functions presented in Listing 12-3.

12-3 USBDev_API

Windows application communicates with a vendor device through *USBDev_API*. The latter is a wrapper developed by Micrium allowing the application to access the WinUSB functionalities to manage a USB device. Windows USB (WinUSB) is a generic driver for USB devices. The WinUSB architecture consists of a kernel-mode driver (`Winusb.sys`) and a user-mode dynamic link library (`Winusb.dll`) that exposes WinUSB functions. *USBDev_API* eases the use of WinUSB by providing a comprehensive API (refer to section G-2 “*USBDev_API* Functions” on page 497 for the complete list). Figure 12-2 shows the *USBDev_API* library and WinUSB.

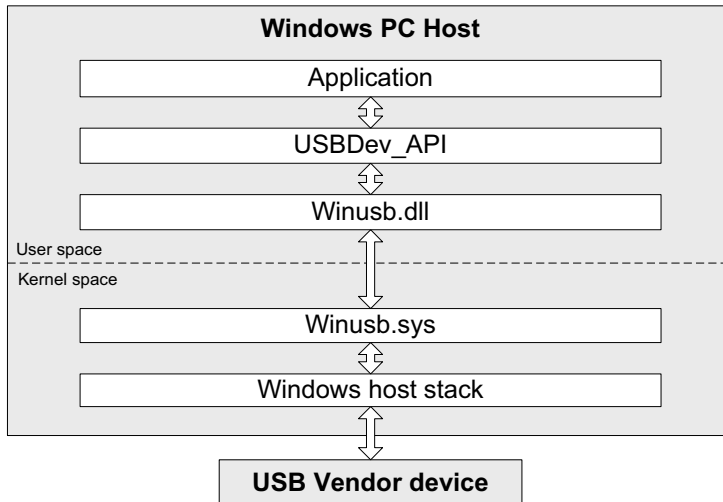

Figure 12-2 USBDev_API and WinUSB

For more about WinUSB architecture, refer to Microsoft’s MSDN online documentation at: [http://msdn.microsoft.com/en-us/library/ff540207\(v=VS.85\).aspx](http://msdn.microsoft.com/en-us/library/ff540207(v=VS.85).aspx)

12-3-1 DEVICE AND PIPE MANAGEMENT

USBDev_API offers the following functions to manage a device and its function’s pipes.

Function name	Operation
USBDev_GetNbrDev()	Gets number of devices belonging to a specified Globally Unique Identifier (GUID) and connected to the host. Refer to section 12-4-4 “GUID” on page 228 for more details about the GUID.
USBDev_Open()	Opens a device.
USBDev_Close()	Closes a device.
USBDev_BulkIn_Open()	Opens a bulk IN pipe.
USBDev_BulkOut_Open()	Opens a bulk OUT pipe.
USBDev_IntIn_Open()	Opens an interrupt IN pipe.
USBDev_IntOut_Open()	Opens an interrupt OUT pipe.
USBDev_PipeClose()	Closes a pipe.

Table 12-5 USBDev_API Device and Pipe Management API

Listing 12-4 shows an example of device and pipe management. The steps to manage a device typically consist in:

- Opening the vendor device connected to the host.
- Opening required pipes for this device.
- Communicating with the device via the open pipes.
- Closing pipes.
- Closing the device.

```
HANDLE dev_handle;
HANDLE bulk_in_handle;
HANDLE bulk_out_handle;
DWORD err;
DWORD nbr_dev;

nbr_dev = USBDev_GetNbrDev(USBDev_GUID, &err);           (1)
if (err != ERROR_SUCCESS) {
    /* $$$ Handle the error. */
}

dev_handle = USBDev_Open(USBDev_GUID, 1, &err);         (2)
if (dev_handle == INVALID_HANDLE_VALUE) {
    /* $$$ Handle the error. */
}

bulk_in_handle = USBDev_BulkIn_Open(dev_handle, 0, 0, &err); (3)
if (bulk_in_handle == INVALID_HANDLE_VALUE) {
    /* $$$ Handle the error. */
}

bulk_out_handle = USBDev_BulkOut_Open(dev_handle, 0, 0, &err); (3)
if (bulk_out_handle == INVALID_HANDLE_VALUE) {
    /* $$$ Handle the error. */
}

/* Communicate with the device. */                       (4)
                                                                    (5)

USBDev_PipeClose(bulk_in_handle, &err);
if (err != ERROR_SUCCESS) {
    /* $$$ Handle the error. */
}
```



```
USBDev_PipeClose(bulk_out_handle, &err);
if (err != ERROR_SUCCESS) {
    /* $$$$ Handle the error. */
}

USBDev_Close(dev_handle, &err);           (6)
if (err != ERROR_SUCCESS) {
    /* $$$$ Handle the error. */
}
```

Listing 12-4 USBDev_API Device and Pipe Management Example

- L12-4(1) Get the number of devices connected to the host under the specified GUID. A GUID provides a mechanism for applications to communicate with a driver assigned to devices in a class. The number of devices could be used in a loop to open at once all the devices. In this example, one device is assumed.
- L12-4(2) Open the device by retrieving a general device handle. This handle will be used for pipe management and communication.
- L12-4(3) Open a bulk pipe by retrieving a pipe handle. In the example, a bulk IN and a OUT pipe are open. If the pipe does not exist for this device, an error is returned. When opening a pipe, the interface number and alternate setting number are specified. In the example, bulk IN and OUT pipes are part of the default interface. Opening an interrupt IN and OUT pipes with `USBDev_IntIn_Open()` or `USBDev_IntOut_Open()` is similar to bulk IN and OUT pipes.
- L12-4(4) Transferring data on the open pipes can take place now. The pipe communication is describes in section 12-3-2 “Device Communication” on page 218.
- L12-4(5) Close a pipe by passing the associated handle. The closing operation aborts any transfer in progress for the pipe and frees any allocated resources.
- L12-4(6) Close the device by passing the associated handle. The operation frees any allocated resources for this device. If a pipe has not been closed by the application, this function will close any forgotten open pipes.

12-3-2 DEVICE COMMUNICATION

SYNCHRONOUS COMMUNICATION

Synchronous communication means that the transfer is blocking. Upon function call, the applications blocks until the end of transfer completed with or without an error. A timeout can be specified to avoid waiting forever. Listing 12-5 presents a read and write example using a bulk IN pipe and a bulk OUT pipe.

```

UCHAR  rx_buf[2];
UCHAR  tx_buf[2];
DWORD  err;

(void)USBDev_PipeRd(bulk_in_handle,           (1)
                   &rx_buf[0],             (2)
                   2u,
                   5000u,                   (3)
                   &err);
if (err != ERROR_SUCCESS) {
    /* $$$ Handle the error. */
}

(void)USBDev_PipeWr(bulk_out_handle,         (1)
                   &tx_buf[0],             (4)
                   2u,
                   5000u,                   (3)
                   &err);
if (err != ERROR_SUCCESS) {
    /* $$$ Handle the error. */
}

```

Listing 12-5 **USBDev_API Synchronous Read and Write Example**

- L12-5(1) The pipe handle gotten with `USBDev_BulkIn_Open()` or `USBDev_BulkOut_Open()` is passed to the function to schedule the transfer for the desired pipe.
- L12-5(2) The application provides a receive buffer to store the data sent by the device.
- L12-5(3) In order to avoid an infinite blocking situation, a timeout expressed in milliseconds can be specified. A value of '0' makes the application thread wait forever. In the example, a timeout of 5 seconds is set.
- L12-5(4) Application provides the transmit buffer that contains the data for the device.

ASYNCHRONOUS COMMUNICATION

Asynchronous communication means that the transfer is non-blocking. Upon function call, the application passes the transfer information to the device stack and does not block. Other application processing can be done while the transfer is in progress over the USB bus. Once the transfer has completed, a callback is called by USBDev_API to inform the application about the transfer completion.

Code Listing 12-6 presents a read example. The asynchronous write is not offered by USBDev_API.

```

UCHAR  rx_buf[2];
DWORD  err;

USBDev_PipeRdAsync(      bulk_in_handle,          (1)
                       &rx_buf[0],             (2)
                       2u,
                       App_PipeRdAsyncComplete, (3)
                       (void *)0u,              (4)
                       &err);

if (err != ERROR_SUCCESS) {
    /* $$$ Handle the error. */
}

static void App_PipeRdAsyncComplete(void *p_buf, (3)
                                     DWORD  buf_len,
                                     DWORD  xfer_len,
                                     void  *p_callback_arg,
                                     DWORD  err)
{
    (void)p_buf;
    (void)buf_len;
    (void)xfer_len;
    (void)p_callback_arg; (4)

    if (err == ERROR_SUCCESS) {
        /* $$$ Process the received data. */
    } else {
        /* $$$ Handle the error. */
    }
}

```

Listing 12-6 USBDev_API Asynchronous Read Example

- L12-6(1) The pipe handle gotten with `USBDev_BulkIn_Open()` is passed to the function to schedule the transfer for the desired pipe.
- L12-6(2) The application provides a receive buffer to store the data sent by the device.
- L12-6(3) The application provides a callback passed as a parameter. Upon completion of the transfer, `USBDev_API` calls this callback so that the application can finalize the transfer by analyzing the transfer result. For instance, upon read operation completion, the application may do a certain processing with the received data.
- L12-6(4) An argument associated to the callback can be also passed. Then in the callback context, some private information can be retrieved.

12-4 USING THE DEMO APPLICATION

Micrium provides a demo application that lets you test and evaluate the class implementation. Source template files are provided for the device. Executable and source files are provided for Windows host PC.

12-4-1 CONFIGURING PC AND DEVICE APPLICATIONS

The demo used between the host and the device is the *Echo* demo. This demo implements a simple protocol allowing the device to echo the data sent by the host.

On the device side, the demo application file, `app_usbd_vendor.c`, provided for μ C/OS-II and μ C/OS-III is located in these two folders:

- `\Micrium\Software\uC-USB-Device-V4\App\Device\OS\uCOS-II`
- `\Micrium\Software\uC-USB-Device-V4\App\Device\OS\uCOS-III`

`app_usbd_vendor.c` contains the Echo demo available in two versions:

- The *Echo Sync* demo exercises the synchronous communication API described in section 12-2-4 “Synchronous Communication” on page 211.
- The *Echo Async* demo exercises the asynchronous communication API described in section 12-2-5 “Asynchronous Communication” on page 212.

The use of these constants defined usually in `app_cfg.h` allows you to use the vendor demo application.

Constant	Description
<code>APP_CFG_USBD_VENDOR_EN</code>	General constant to enable the Vendor class demo application. Must be set to <code>DEF_ENABLED</code> .
<code>APP_CFG_USBD_VENDOR_ECHO_SYNC_EN</code>	Enables or disables the Echo Sync demo. The possible values are <code>DEF_ENABLED</code> or <code>DEF_DISABLED</code> .
<code>APP_CFG_USBD_VENDOR_ECHO_ASYNC_EN</code>	Enables or disables the Echo Async demo. The possible values are <code>DEF_ENABLED</code> or <code>DEF_DISABLED</code> .
<code>APP_CFG_USBD_VENDOR_ECHO_SYNC_TASK_PRIO</code>	Priority of the task used by the Echo Sync demo.
<code>APP_CFG_USBD_VENDOR_ECHO_ASYNC_TASK_PRIO</code>	Priority of the task used by the Echo Async demo.
<code>APP_CFG_USBD_VENDOR_TASK_STK_SIZE</code>	Stack size of the tasks used by Echo Sync and Async demos. A default value can be 256.

Table 12-6 Device Application Constants Configuration

`APP_CFG_USBD_VENDOR_ECHO_SYNC_EN` and `APP_CFG_USBD_VENDOR_ECHO_ASYNC_EN` can be set to `DEF_ENABLED` at the same time. The vendor device created will be a composite device formed with two vendor interfaces. One will represent the Echo Sync demo and the other the Echo Async demo.

On the Windows side, the demo application file, `app_vendor_echo.c`, is part of a Visual Studio solution located in this folder:

```
\Micrium\Software\uC-USB-Device-V4\App\Host\OS\Windows\Vendor\Visual Studio 2010
```

`app_vendor_echo.c` allows you to test:

- One single device. That is Echo Sync or Async demo is enabled on the device side.
- One composite device. That is Echo Sync and Async demos are both enabled on the device side.
- Multiple devices (single or composite devices).

`app_vendor_echo.c` contains some constants to customize the demo.

Constant	Description
<code>APP_CFG_RX_ASYNC_EN</code>	Enables or disables the use of the asynchronous API for IN pipe. The possible values are <code>TRUE</code> or <code>FALSE</code> .
<code>APP_MAX_NBR_VENDOR_DEV</code>	Defines the maximum number of connected vendor devices supported by the demo.

Table 12-7 Windows Application Constants Configuration

The constants configuration for the Windows application are independent from the device application constants configuration presented in Table 12-6.

12-4-2 EDITING AN INF FILE

An INF file contains directives telling to Windows how to install one or several drivers for one or more devices. Refer to section 3-1-1 “About INF Files” on page 46 for more details about INF file use and format. The Vendor class includes two INF files located in `\Micrium\Software\uC-USB-Device-V4\App\Host\OS\Windows\Vendor\INF`:

- `WinUSB_single.inf`, used if the device presents only one Vendor class interface.
- `WinUSB_composite.inf`, used if the device presents at least one Vendor class interface along with another interface.

The two INF files allows you to load the `WinUSB.sys` driver provided by Windows. `WinUSB_single.inf` defines this default hardware ID string:

```
USB\VID_FFFE&PID_1003
```

While `WinUSB_composite.inf` defines this one:

```
USB\VID_FFFE&PID_1001&MI_00
```

The hardware ID string contains the Vendor ID (VID) and Product ID (PID). In the default strings, the VID is FFFE and the PID is either 1003 or 1001. The VID/PID values should match the ones from the USB device configuration structure defined in `usb_dev_cfg.c`. Refer to section “Modify Device Configuration” on page 34 for more details about the USB

device configuration structure.

If you want to define your own VID/PID, you must modify the previous default hardware ID strings with your VID/PID.

In the case of a composite device formed of several vendor interfaces, in order to load WinUSB.sys for each vendor interface, the manufacturer section in `WinUSB_composite.inf` can be modified as shown in Listing 12-7. Let's assume a device with two vendor interfaces.

```
[MyDevice_WinUSB.NTx86]
%USB\MyDevice.DeviceDesc% =USB_Install, USB\VID_FFFE&PID_1001&MI_00
%USB\MyDevice.DeviceDesc% =USB_Install, USB\VID_FFFE&PID_1001&MI_01

[MyDevice_WinUSB.NTamd64]
%USB\MyDevice.DeviceDesc% =USB_Install, USB\VID_FFFE&PID_1001&MI_00
%USB\MyDevice.DeviceDesc% =USB_Install, USB\VID_FFFE&PID_1001&MI_01

[MyDevice_WinUSB.NTia64]
%USB\MyDevice.DeviceDesc% =USB_Install, USB\VID_FFFE&PID_1001&MI_00
%USB\MyDevice.DeviceDesc% =USB_Install, USB\VID_FFFE&PID_1001&MI_01
```

Listing 12-7 INF File Example for Composite Device Formed of Several Vendor Interfaces.

You can also modify the [Strings] section of the INF file in order to add the strings that best describe your device. Listing 12-8 shows the editable [Strings] section common to `WinUSB_single.inf` and `WinUSB_composite.inf`.

```
[Strings]
ProviderName           ="Micrium"                (1)
USB\MyDevice.DeviceDesc ="Micrium Vendor Specific Device" (2)
ClassName              ="USB Sample Class"          (3)
```

Listing 12-8 Editable Strings in the INF File to Describe the Vendor Device.

L12-8(1) Specify the name of your company as the driver provider.

L12-8(2) Write the name of your device.

L12-8(3) You can modify this string to give a new name to the device group in which your device will appear under Device Manager. In this example, “Micrium Vendor Specific Device” will appear under the “USB Sample Class” group. Refer to Figure 3-1 “Windows Device Manager Example for a CDC Device” on page 50 for an illustration of the strings use by Windows.

12-4-3 RUNNING THE DEMO APPLICATION

Figure 12-3 presents the Echo demo with host and device interactions:



Figure 12-3 Echo Demo

F12-3(1) The Windows application executes a simple protocol consisting of sending a header indicating the total payload size, sending the data payload to the device and receiving the same data payload from the device. The entire transfer for data payload is split into small chunks of write and read operations of 512 bytes. The write operation is done using a bulk OUT endpoint and the read uses a bulk IN endpoint.

- F12-3(2) On the device side, the Echo Sync uses a task that complements the Windows application execution. Each step is done synchronously. The read and write operation is the opposite of the host side in terms of USB transfer direction. Read operation implies a bulk OUT endpoint while a write implies a bulk IN endpoint.
- F12-3(3) If the Echo Async is enabled, the same steps done by the Sync task is replicated but using the asynchronous API. A task is responsible to start the first asynchronous OUT transfer to receive the header. The task is also used in case of error during the protocol communication. The callback associated to the header reception is called by the device stack. It prepares the next asynchronous OUT transfer to receive the payload. The read payload callback sends back the payload to the host via an asynchronous IN transfer. The write payload callback is called and either prepares the next header reception if the entire payload has been sent to the host or prepares a next OUT transfer to receive a new chunk of data payload.

Upon the first connection of the vendor device, Windows enumerates the device by retrieving the standard descriptors. Since Microsoft does not provide any specific driver for the Vendor class, you have to indicate to Windows which driver to load using an INF file (refer to section 3-1-1 “About INF Files” on page 46 to for more details about INF). The INF file tells Windows to load the WinUSB generic driver (provided by Microsoft). Indicating the INF file to Windows has to be done only once. Windows will then automatically recognize the vendor device and load the proper driver for any new connection. The process of indicating the INF file may vary according to the Windows operating system version:

- Windows XP directly opens the “Found New Hardware Wizard”. Follow the different steps of the wizard until the page where you can indicate the path of the INF file.
- Windows Vista and later won’t open a “Found New Hardware Wizard”. It will just indicate that no driver was found for the vendor device. You have to manually open the wizard. Open the Device Manager, the vendor device connected appears under the category ‘Other Devices’ with a yellow icon. Right-click on your device and choose ‘Update Driver Software...’ to open the wizard. Follow the different steps of the wizard until the page where you can indicate the path of the INF file.

The INF file is located in:

```
\Micrium\Software\uC-USB-Device-V4\App\Host\OS\Windows\Vendor\INF
```

Refer to section 3-1-1 “About INF Files” on page 46 for more details about how to edit the INF file to match your Vendor and Product IDs.

Once the driver is successfully loaded, the Windows host application is ready to be launched. The executable is located in the following folder:

```
\Micrium\Software\uC-USB-Device-V4\App\Host\OS\Windows\Vendor\Visual Studio 2010\exe\
```

There are two executables:

- *EchoSync.exe* for the Windows application with the synchronous communication API of USBDev_API.
- *EchoAsync.exe* for the Windows application with the asynchronous IN API of USBDev_API.

The Windows application interacts with WinUSB driver via USBDev_API which is a wrapper of WinUSB driver. USBDev_API is provided by Micrium. Refer to section 12-3 “USBDev_API” on page 214 for more details about USBDev_API and WinUSB driver.

The Echo Sync or Async demo will first determine the number of vendor devices connected to the PC. For each detected device, the demo will open a bulk IN and a bulk OUT pipe. Then the demo is ready to send/receive data to/from the device. You will have to enter the maximum number of transfers you want as shown by Figure 12-4.

```
C:\Micrium\Software\uC-USB-Device-V4\App\Host\OS\Windows\Vendor\Visual Studio 2010\exe\...
Number of devices attached = 1
>> Device #1 open.
>> Device #1: WinUSB internal alternate setting set.
>> Device #1: 1 interface(s) = default IF + 0 associated interface(s).
>> Device #1 attached is FULL-SPEED.
>> Device #1 (IF0): Bulk IN pipe open.
>> Device #1 (IF0): Bulk OUT pipe open.
-----
Communication with default interface of USB Device #1
-----
>>> Specify the number of transfers: 10
```

Figure 12-4 Demo Application at Startup

In the example of Figure 12-4, the demo will handle 10 transfers. Each transfer is sent after the header following the simple protocol described in Figure 12-3. The first transfer will have a data payload of 1 byte. Then subsequent transfers will have their size incremented of 1 byte until the last transfer. In our example, the last transfer will have 10 bytes. Figure 12-5 presents the execution.



```
C:\Micrium\Software\uC-USB-Device-V4\App\Host\OS\Windows\Vendor\Visual Studio 2010\exe\x...
Number of devices attached = 1
>> Device #1 open.
>> Device #1: WinUSB internal alternate setting set.
>> Device #1: 1 interface(s) = default IF + 0 associated interface(s).
>> Device #1 attached is FULL-SPEED.
>> Device #1 (IF0): Bulk IN pipe open.
>> Device #1 (IF0): Bulk OUT pipe open.

-----
Communication with default interface of USB Device #1 -
-----
--> Specify the number of transfers: 10

Sending/Receiving [1] bytes...OK
Sending/Receiving [2] bytes...OK
Sending/Receiving [3] bytes...OK
Sending/Receiving [4] bytes...OK
Sending/Receiving [5] bytes...OK
Sending/Receiving [6] bytes...OK
Sending/Receiving [7] bytes...OK
Sending/Receiving [8] bytes...OK
Sending/Receiving [9] bytes...OK
Sending/Receiving [10] bytes...OK
----> Device #1 (IF0): communication successful!

Do you want to continue ? (YES = y or Y, NO = n or N) y

-----
Communication with default interface of USB Device #1 -
-----
--> Specify the number of transfers: 2545
```

Figure 12-5 Demo Application Execution (Single Device)

The demo will propose to do a new execution. Figure 12-5 shows the example of a single device with 1 vendor interface. The demo is able to communicate with each vendor interface in the case of a composite device. In that case, the demo will open bulk IN and OUT pipes for each interface. You will be asked the maximum number of transfers for each interface composing the device. Figure 12-6 shows an example of composite device.

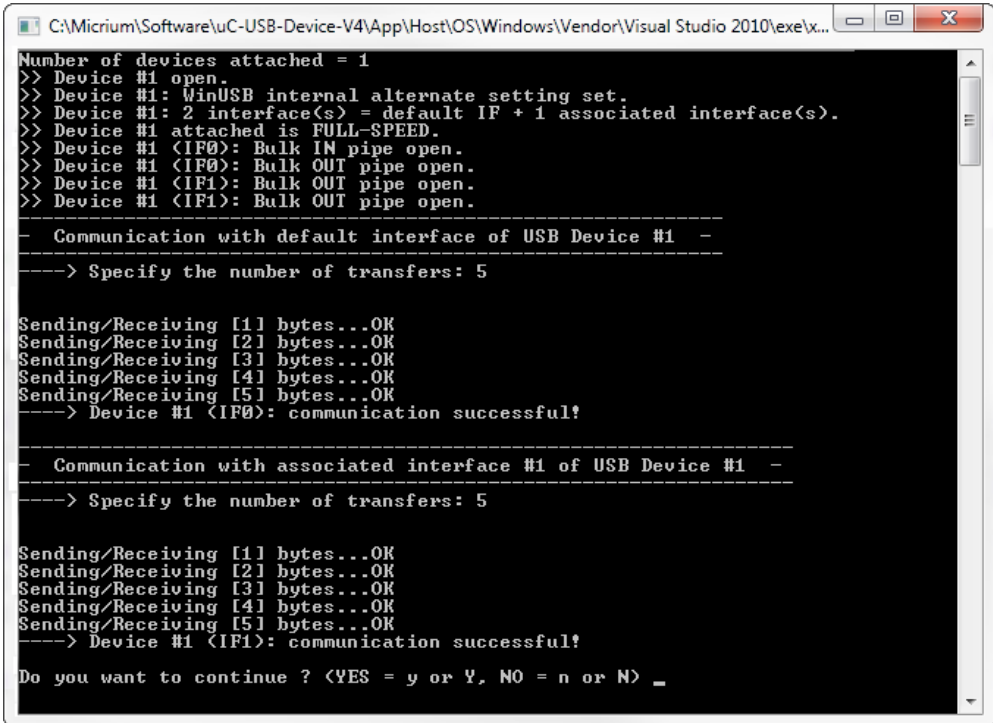

```
C:\Micrium\Software\uC-USB-Device-V4\App\Host\OS\Windows\Vendor\Visual Studio 2010\exe\x...
Number of devices attached = 1
>> Device #1 open.
>> Device #1: MinUSB internal alternate setting set.
>> Device #1: 2 interface(s) = default IF + 1 associated interface(s).
>> Device #1 attached is FULL-SPEED.
>> Device #1 (IF0): Bulk IN pipe open.
>> Device #1 (IF0): Bulk OUT pipe open.
>> Device #1 (IF1): Bulk OUT pipe open.
>> Device #1 (IF1): Bulk OUT pipe open.
-----
- Communication with default interface of USB Device #1 -
-----
----> Specify the number of transfers: 5
-----
Sending/Receiving [1] bytes...OK
Sending/Receiving [2] bytes...OK
Sending/Receiving [3] bytes...OK
Sending/Receiving [4] bytes...OK
Sending/Receiving [5] bytes...OK
----> Device #1 (IF0): communication successful!
-----
- Communication with associated interface #1 of USB Device #1 -
-----
----> Specify the number of transfers: 5
-----
Sending/Receiving [1] bytes...OK
Sending/Receiving [2] bytes...OK
Sending/Receiving [3] bytes...OK
Sending/Receiving [4] bytes...OK
Sending/Receiving [5] bytes...OK
----> Device #1 (IF1): communication successful!
Do you want to continue ? <YES = y or Y, NO = n or N> _
```

Figure 12-6 Demo Application Execution (Composite Device)

12-4-4 GUID

A Globally Unique Identifier (GUID) is a 128-bit value that uniquely identifies a class or other entity. Windows uses GUIDs for identifying two types of device classes:

- Device setup class
- Device interface class

A device setup GUID encompasses devices that Windows installs in the same way and using the same class installer and co-installers. Class installers and co-installers are DLLs that provide functions related to the device installation. A device interface class GUID provides a mechanism for applications to communicate with a driver assigned to devices in a class. Refer to section 3-1-2 “Using GUIDs” on page 51 for more details about the GUID.

Device setup class GUID is used in `WinUSB_single.inf` and `WinUSB_composite.inf` located in `\Micrium\Software\uC-USB-Device-V4\App\Host\OS\Windows\Vendor\INF`. These INF files define a new device setup class that will be added in the Windows registry under `HKEY_LOCAL_MACHINE\System\CurrentControlSet\Control\Class` upon first connection of a vendor device. The following entries in the INF file define the new device setup class.

```
Class      = MyDeviceClass                ; Name of the device setup class.
ClassGuid  = {11111111-2222-3333-4444-555555555555} ; Device setup class GUID
```

The INF files allows Windows to register in the registry base all the information necessary to associate the driver `Winusb.sys` with the connected vendor device.

The Windows Echo application is able to retrieve the attached vendor device thanks to the device interface class GUID. `WinUSB_single.inf` and `WinUSB_composite.inf` define the following device interface class GUID: `{143f20bd-7bd2-4ca6-9465-8882f2156bd6}`. The Echo application includes a header file called `usbdev_guid.h`. This header file defines the following variable:

```
GUID USBDev_GUID = {0x143f20bd,0x7bd2,0x4ca6,{0x94,0x65,0x88,0x82,0xf2,0x15,0x6b,0xd6}};
```

`USBDev_GUID` is a structure whose fields represent the device interface class GUID defined in `WinUSB_single.inf` and `WinUSB_composite.inf`. The `USBDev_GUID` variable will be passed as a parameter to the function `USBDev_Open()`. An handle will be returned by `USBDev_Open()`. The application uses this handle to access the device.

Chapter

13

Debug and Trace

μ C/USB-Device provides an option to enable debug traces to output transactional activity via an output port of your choice such as the console or serial port. Debugging traces allows you to see how the USB device stack behaves and is a useful troubleshooting tool when trying to debug a problem. This chapter will show you the debug and trace tools available in the USB device core as well as how to go about using them.

13-1 USING DEBUG TRACES

13-1-1 DEBUG CONFIGURATION

There are several configuration constants necessary to customize the core level debugging traces. These constants are found in `usbd_cfg.h` and are summarized in Table 13-1.

Constant	Description
<code>USBD_CFG_DBG_TRACE_EN</code>	This constant enables core level debugging traces in the program so that transactional activity can be outputted.
<code>USBD_CFG_DBG_TRACE_NBR_EVENTS</code>	This constant configures the size of the debug event pool to store debug events.

Table 13-1 General Configuration Constants

13-1-2 DEBUG TRACE OUTPUT

Core level debug traces are outputted from the debug task handler via an application defined trace function `USBD_Trace()`. This function is located in `app_usbd.c` and it is up to you to define how messages are outputted whether through console terminal `printf()` statements or serial `printf()` statements for example. Listing 13-1 shows an example of an implementation for `USBD_Trace()` with a serial `printf()` function.

```
void USBD_Trace (const CPU_CHAR *p_str)
{
    App_SerPrintf("%s", (CPU_CHAR *)p_str);
}
```

Listing 13-1 `USBD_Trace()` Example

13-1-3 DEBUG FORMAT

The debug task handler follows a simple format when outputting debug events. The format is as follows:

```
USB <timestamp> <endpoint address> <interface number> <error/info message>
```

In the event that timestamp, endpoint address, interface number or error messages are not provided, they are left void in the output. An example output is shown in Listing 13-2. This example corresponds to traces placed in the USB device core and device driver functions. This trace shows the enumeration process where bus events are received and related endpoints are opened in the device driver. Next, a setup event is sent to the core task followed by receiving the first Get Device Descriptor standard request.

```

USB      0          Bus Reset
USB      0 80          Drv EP DMA Open
USB      0 0          Drv EP DMA Open
USB      0          Bus Suspend
USB      0          Bus Reset
USB      0 80          Drv EP DMA Close
USB      0 0          Drv EP DMA Close
USB      0 80          Drv EP DMA Open
USB      0 0          Drv EP DMA Open
USB      0          Drv ISR Rx (Fast)
USB      0 0          Setup pkt
USB      0 0          Drv ISR Rx Cmpl (Fast)
USB      0          Drv ISR Rx (Fast)
USB      0 0          Get descriptor(Device)
USB      0 80          Drv EP FIFO Tx Len: 18
USB      0 80          Drv EP FIFO Tx Start Len: 18
USB      0          Drv ISR Rx (Fast)
USB      0 80          Drv ISR Tx Cmpl (Fast)
USB      0 0          Drv ISR Rx Cmpl (Fast)
USB      0          Drv ISR Rx (Fast)
USB      0 0          Drv EP FIFO RxZLP
USB      0          Drv ISR Rx (Fast)
...

```

Listing 13-2 Sample Debug Output

13-2 HANDLING DEBUG EVENTS

13-2-1 DEBUG EVENT POOL

A pool is used to keep track of debugging events. This pool is made up of debug event structures where the size of the pool is specified by `USB_D_CFG_DBG_TRACE_NBR_EVENTS` in the application configuration. Within the core, each time a new debug standard request is received, the message's details will be set into a debug event structure and queued into the pool. Once the debug event is properly queued, a ready signal is invoked to notify the debug task handler that an event is ready to be processed.

13-2-2 DEBUG TASK

An OS-dependent task is used to process debug events. The debug task handler simply pends until an event ready signal is received and obtains a pointer to the first debug event structure from the pool. The details of the debug event structure is then formatted and outputted via the application trace function. At the end of the output, the debug event structure is then subsequently freed and the debug task will pend and process the next debug event structure ready. Refer to section 4-2-3 "Processing Debug Events" on page 63 for details on processing debug events.

13-2-3 DEBUG MACROS

Within the core, several macros are created to set debug messages. These macros are defined in `usb_core.h` and make use of the core functions `USB_D_Dbg()` and `USB_D_DbgArg()` that will set up a debug event structure and put the event into the debug event pool. These macros are defined in Listing 13-3.

```
#define USBD_DBG_GENERIC(msg, ep_addr, if_nbr)          USBD_Dbg((msg),          \
                                                       (ep_addr),          \
                                                       (if_nbr),          \
                                                       USBD_ERR_NONE)

#define USBD_DBG_GENERIC_ERR(msg, ep_addr, if_nbr, err)  USBD_Dbg((msg),          \
                                                       (ep_addr),          \
                                                       (if_nbr),          \
                                                       (err))

#define USBD_DBG_GENERIC_ARG(msg, ep_addr, if_nbr, arg)  USBD_DbgArg((msg),          \
                                                       (ep_addr),          \
                                                       (if_nbr),          \
                                                       (CPU_INT32U)(arg), \
                                                       (USBD_ERR_NONE))

#define USBD_DBG_GENERIC_ARG_ERR(msg, ep_addr, if_nbr, arg, err)  USBD_DbgArg((msg),          \
                                                       (ep_addr),          \
                                                       (if_nbr),          \
                                                       (CPU_INT32U)(arg), \
                                                       (err))
```

Listing 13-3 Core Level Debug Macros

There are subtle yet important differences between each debug macro. The first debug macro is the most simple, specifying just the debug message, endpoint address and interface number as parameters. The second and third macros differ in the last parameter where one specifies the error and the other specifies an argument of choice. The last macro lets the caller specify all details including both error and argument.

Furthermore, core level debug macros can be further mapped to other macros to simplify the repetition of endpoint address and interface number parameters. Listing 13-4 shows an example of a bus specific debug macro and a standard debug macro found in `usbd_core.c`.

```
# define USBD_DBG_CORE_BUS(msg)          USBD_DBG_GENERIC(msg),          \  
                                          USBD_EP_ADDR_NONE,          \  
                                          USBD_IF_NBR_NONE)  
  
# define USBD_DBG_CORE_STD(msg)          USBD_DBG_GENERIC(msg),          \  
                                          0u,                          \  
                                          USBD_IF_NBR_NONE)
```

Listing 13-4 Mapped Core Tracing Macros

Porting μ C/USB-Device to your RTOS

μ C/USB-Device requires a Real-Time Operating System (RTOS). In order to make it usable with nearly any RTOS available on the market, it has been designed to be easily portable. Micrium provides ports for both μ C/OS-II and μ C/OS-III and recommends using one of these RTOS. In case you need to use another RTOS, this chapter will explain you how to port μ C/USB-Device to your RTOS.

14-1 OVERVIEW

μ C/USB-Device uses some RTOS abstraction ports to interact with the RTOS. Instead of being a simple wrapper for common RTOS service functions (`TaskCreate()`, `SemaphorePost()`, etc...), those ports are in charge of allocating and managing all the OS resources needed. All the APIs are related to the μ C/USB-Device module feature that uses it. This offers you a better flexibility of implementation as you can decide which OS services can be used for each specific action. Table 14-1 gives an example of comparison between a simple RTOS functions wrapper port and a features-oriented RTOS port.

Operation	Example of feature-oriented function (current implementation)	Equivalent function in a simple wrapper (not used)
Create a task	The stack is not in charge of creating tasks. This should be done in the RTOS abstraction layer within a <code>USBD_OS_Init()</code> function, for example.	<code>USBD_OS_TaskCreate()</code> . The stack would need to explicitly create the needed tasks and to manage them.
Create a signal for an endpoint	<code>USBD_OS_EP_SignalCreate()</code> . You are free to use another OS service than a typical Semaphore.	<code>USBD_OS_SemCreate()</code> . The stack would need to explicitly choose the OS service to use.
Put a core event in a queue	<code>USBD_OS_CoreEventPut()</code> . If you prefer not using typical OS queues, you could still implement it using a chained list and a semaphore, for instance.	<code>USBD_OS_Q_Post()</code> . Again, the stack would need to explicitly choose the OS service to use.

Table 14-1 Comparison between a wrapper and a features-oriented RTOS port

Because of the features oriented RTOS port design, some μ C/USB-Device modules will need their own OS port. These modules are listed here:

- μ C/USB-Device core layer
- Personal Healthcare Device Class (PHDC)
- Human Interface Device Class (HID)
- Mass Storage Class (MSC)

Moreover, all the demo applications for each USB class that Micrium provides interact with the RTOS. The demo applications do not benefit from a RTOS port. Hence, if you plan to use them with another RTOS than $\mu\text{C}/\text{OS-II}$ or $\mu\text{C}/\text{OS-III}$, you will have to modify them.

Figure 14-1 summarizes the interactions between the different $\mu\text{C}/\text{USB-Device}$ modules and the RTOS.



Figure 14-1 $\mu\text{C}/\text{USB-Device}$ architecture with RTOS interactions

14-2 PORTING MODULES TO A RTOS

Table 14-2 lists the section of this manual to which you should refer to for an explanation on how to port $\mu\text{C}/\text{USB-Device}$ modules to a RTOS.

Module	Refer to...
Core layer	Section 14-4 “Porting The Core Layer to a RTOS” on page 242
PHDC	Section 11-6 “Porting PHDC to a RTOS” on page 203
HID	Section 9-5 “Porting the HID Class to a RTOS” on page 160
MSC	Section 10-6 “Porting MSC to a Storage Layer” on page 180

Table 14-2 List of sections to refer to port a module to a RTOS

14-3 CORE LAYER RTOS MODEL

The core layer of μ C/USB-Device needs an RTOS for three purposes:

- Signal the completion of synchronous transfers.
- Manage core events.
- Manage debug events (optional).

14-3-1 SYNCHRONOUS TRANSFER COMPLETION SIGNALS

The core layer needs a way to signal the application about the synchronous transfer completion. The core will need one signal per endpoint. The RTOS resources usually used for this signal is a semaphore. Figure 14-2 describes a synchronous transfer completion notification.



Figure 14-2 Synchronous transfer completion notification

- F14-2(1) Application task calls a synchronous transfer function.
- F14-2(2) While the transfer is in progress, the application task pends on the transfer completion signal.
- F14-2(3) Once the transfer is completed, the core will post the transfer completion signal which will resume the application task.

14-3-2 CORE EVENTS MANAGEMENT

For proper operation, the core layer needs an OS task that will manage the core events. For more information on the purpose of this task or on what a core event is, refer to section 4-2 “Task Model” on page 58. The core events must be queued in a data structure and be processed by the core. This allows the core to process the events in a task context instead of in an ISR context, as most of the events will be raised by the device driver’s ISR. The core task also needs to be informed when a new event is queued. Figure 14-3 describes the core events management within the RTOS port.



Figure 14-3 Core events management within RTOS port

F14-3(1) A core event is added to the queue.

F14-3(2) The core task of the core layer pends on the queue. Whenever an event is added, the core task is resumed to process it.

14-3-3 DEBUG EVENTS MANAGEMENT

The core layer of μ C/USB-Device offers an optional feature to do tracing and debugging. For more information on this feature, see Chapter 13, “Debug and Trace” on page 231. This feature requires an OS task. For more information on the purpose of this task or on debug events, refer to section 4-2 “Task Model” on page 58. The behavior of this task is similar to

the core task described in Section 14-3-2. The difference is that the RTOS port does not need to manage the queue, as it is handled within the core layer. The RTOS port only needs to provide a signal that will inform of a debug event insertion.

14-4 PORTING THE CORE LAYER TO A RTOS

The core RTOS port is located in a separate file named `usbd_os.c`. A template file can be found in the following folder:

```
\Micrium\Software\uC-USB-Device-V4\OS\Template
```

Table 14-3 summarizes all the functions that need to be implemented in the RTOS port file. For more information on how these functions should be implemented, refer to section 14-3 on page 240 and to section A-5 “Core OS Functions” on page 298.

Function name	Operation
<code>USBD_OS_Init()</code>	Initializes all internal members / tasks.
<code>USBD_OS_EP_SignalCreate()</code>	Creates OS signal used to synchronize synchronous transfers.
<code>USBD_OS_EP_SignalDel()</code>	Deletes OS signal used to synchronize synchronous transfers.
<code>USBD_OS_EP_SignalPend()</code>	Pends on OS signal used to synchronize synchronous transfers.
<code>USBD_OS_EP_SignalAbort()</code>	Aborts OS signal used to synchronize synchronous transfers.
<code>USBD_OS_EP_SignalPost()</code>	Posts OS signal used to synchronize synchronous transfers.
<code>USBD_OS_DbgEventRdy()</code>	Posts signal used to resume debug task.
<code>USBD_OS_DbgEventWait()</code>	Pends on signal used to resume debug task.
<code>USBD_OS_CoreEventGet()</code>	Retrieves the next core event to process.
<code>USBD_OS_CoreEventPut()</code>	Adds a core event to be processed by the core.

Table 14-3 Core OS port API summary

Note that you must declare at least one task for the core events management within your RTOS port. This task should simply call the core function `USBD_CoreTaskHandler()` in an infinite loop. Furthermore, if you plan using the debugging feature, you must also create a

task for this purpose. This task should simply call the core function `USB_DbgTaskHandler()` in an infinite loop. Listing 14-1 shows how these two task functions body should be implemented.

```
static void USBD_OS_CoreTask (void *p_arg)
{
    p_arg = p_arg;

    while (DEF_ON) {
        USBD_CoreTaskHandler();
    }
}

static void USBD_OS_TraceTask (void *p_arg)
{
    p_arg = p_arg;

    while (DEF_ON) {
        USBD_DbgTaskHandler();
    }
}
```

Listing 14-1 Core task and debug task typical implementation

Appendix

A

Core API Reference

This appendix provides a reference to the μ C/USB-Device core layer API. The following information is provided for each of the services:

- A brief description
- The function prototype
- The filename of the source code
- A description of the arguments passed to the function
- A description of returned value(s)
- Specific notes and warnings regarding use of the service

A-1 DEVICE FUNCTIONS

A-1-1 USBD_Init()

Initialize USB device stack. This function is called by the application exactly once. This function initializes all the internal variables and modules used by the USB device stack.

FILES

usbd_core.h/usbd_core.c

PROTOTYPE

```
static void USBD_Init (USB_ERR *p_err);
```

ARGUMENTS

p_err Pointer to variable that will receive the return error code from this function.

 USB_ERR_NONE

 USB_ERR_OS_INIT_FAIL

RETURNED VALUE

None.

CALLERS

Application.

NOTES / WARNINGS

USBD_Init() must be called:

- Only once from a product's application.
- After product's OS has been initialized
- Before product's application calls any USB device stack function(s).

A-1-2 USBD_DevStart()

Starts device stack. This function connects the device to the USB host.

FILES

usbd_core.h/usbd_core.c

PROTOTYPE

```
void USBD_DevStart (CPU_INT08U dev_nbr,  
                   USB_ERR *p_err);
```

ARGUMENTS

dev_nbr Device number.

p_err Pointer to variable that will receive the return error code from this function.

USB_ERR_NONE

USB_ERR_DEV_INVALID_NBR

USB_ERR_DEV_INVALID_STATE

RETURNED VALUE

None.

CALLERS

Application.

NOTES / WARNINGS

Device stack can be only started if the device is in either the `USB_DEV_STATE_NONE` or `USB_DEV_STATE_INIT` states.

A-1-3 USBD_DevStop()

Stops device stack. This function disconnects the device from the USB host.

FILES

usb_core.h/usb_core.c

PROTOTYPE

```
void USBD_DevStop (CPU_INT08U dev_nbr,  
                  USBD_ERR *p_err);
```

ARGUMENTS

dev_nbr Device number.

p_err Pointer to variable that will receive the return error code from this function.

USB_ERR_NONE

USB_ERR_DEV_INVALID_NBR

USB_ERR_DEV_INVALID_STATE

RETURNED VALUE

None.

CALLERS

Application.

NOTES / WARNINGS

None.

A-1-4 USBD_DevGetState()

Gets current device state.

FILES

usbd_core.h/usbd_core.c

PROTOTYPE

```
USBDEV_STATE USBD_DevGetState (CPU_INT08U dev_nbr,  
                                USBDEV_ERR *p_err);
```

ARGUMENTS

dev_nbr Device number.

p_err Pointer to variable that will receive the return error code from this function.

USBDEV_ERR_NONE

USBDEV_ERR_DEV_INVALID_NBR

RETURNED VALUE

Current device state, If no error(s).

USBDEV_STATE_NONE, otherwise.

CALLERS

USBDEV_EP_BulkRx()

USBDEV_EP_BulkRxAsync()

USBDEV_EP_BulkTx()

USBDEV_EP_BulkTxAsync()

USBDEV_EP_CtrlRx()

USBDEV_EP_CtrlRxStatus()

USBDEV_EP_CtrlTx()

USBDEV_EP_IntrRx()

```
USBD_EP_IntrRxAsync()  
USBD_EP_IntrTx()  
USBD_EP_IntrTxAsync()
```

NOTES / WARNINGS

None.

A-1-5 USBD_DevAdd()

Adds device to the stack.

FILES

usbd_cdc.h/usbd_cdc.c

PROTOTYPE

```
CPU_INT08U USBD_DevAdd (USBDEVCFG *p_dev_cfg,  
                        USBDEVCFG *p_bus_funct,  
                        USBDRVAPI *p_drv_api,  
                        USBDEVCFG *p_drv_cfg,  
                        USBDRVBSAPI *p_bsp_api,  
                        USBERR *p_err);
```

ARGUMENTS

- p_dev_cfg** Pointer to specific USB device configuration
- p_bus_funct** Pointer to specific USB device configuration
- p_drv_api** Pointer to specific USB device driver API.
- p_drv_cfg** Pointer to specific USB device driver configuration.
- p_bsp_api** Pointer to specific USB device board-specific API.
- p_err** Pointer to variable that will receive the return error code from this function.

```
USBDEVCFG_NONE  
USBDEVCFG_INVALID_ARG  
USBDEVCFG_NULL_PTR  
USBDEVCFG_DEV_ALLOC  
USBDEVCFG_EP_NONE_AVAIL
```

RETURNED VALUE

Device number, If no error(s).

USBDEV_NBR_NONE, otherwise.

CALLERS

Application.

NOTES / WARNINGS

None.

A-2 CONFIGURATION FUNCTIONS

A-2-1 USBD_CfgAdd()

Adds a configuration to the device.

FILES

usb_core.h/usb_core.c

PROTOTYPE

```
CPU_INT08U  USBD_CfgAdd (      CPU_INT08U  dev_nbr,
                               CPU_INT08U  attrib,
                               CPU_INT16U  max_pwr,
                               USBDEV_SPD  spd,
                               const CPU_CHAR *p_name,
                               USBDEV_ERR  *p_err);
```

ARGUMENTS

dev_nbr Device number.

attrib Configuration attributes.

USBDEV_ATTRIB_SELF_POWERED
USBDEV_ATTRIB_REMOTE_WAKEUP

max_pwr Bus power required for this device (see Note #1).

spd Configuration speed.

USBDEV_SPD_FULL
USBDEV_SPD_HIGH

p_name Pointer to string describing the configuration (See Note #2).

p_err Pointer to variable that will receive the return error code from this function.

```

USBD_ERR_NONE
USBD_ERR_DEV_INVALID_NBR
USBD_ERR_DEV_INVALID_STATE
USBD_ERR_CFG_ALLOC
USBD_ERR_CFG_INVALID_MAX_PWR

```

RETURNED VALUE

Configuration number, If no error(s).

USBD_CFG_NBR_NONE, otherwise.

CALLERS

Application.

NOTES / WARNINGS

- USB spec 2.0, section 7.2.1.3/4 defines power constrains for bus-powered devices:
 - “A low-power function is one that draws up to one unit load from the USB cable when operational”
 - “A function is defined as being high-power if, when fully powered, it draws over one but no more than five unit loads from the USB cable.”
 - A unit load is defined as 100mA, thus **max_pwr** argument should be between 0 mA and 500mA.
- String support is optional, in this case '**p_name**' can be a **NULL** string pointer.
- Configuration can only be added when the device is in either the **USBD_DEV_STATE_NONE** or **USB_DEV_STATE_INIT** states.

A-3 INTERFACE FUNCTIONS

A-3-1 USBD_IF_Add()

Send data on CDC data class interface.

FILES

usbd_cdc.h/usbd_cdc.c

PROTOTYPE

```

CPU_INT08U  USBD_IF_Add (      CPU_INT08U      dev_nbr,
                              CPU_INT08U      cfg_nbr,
                              USBD_CLASS_DRV  *p_class_drv,
                              void            *p_class_arg,
                              CPU_INT08U      class_code,
                              CPU_INT08U      class_sub_code,
                              CPU_INT08U      class_protocol_code,
                              const CPU_CHAR  *p_name,
                              USBD_ERR        *p_err);

```

ARGUMENTS

<code>dev_nbr</code>	Device number.
<code>cfg_nbr</code>	Configuration index to add the interface.
<code>p_class_drv</code>	Pointer to interface driver.
<code>p_class_arg</code>	Pointer to interface driver argument.
<code>class_code</code>	Class code assigned by the USB-IF.
<code>class_sub_code</code>	Subclass code assigned by the USB-IF.
<code>class_protocol_code</code>	Protocol code assigned by the USB-IF.
<code>p_name</code>	Pointer to string describing the Interface.

p_err Pointer to variable that will receive the return error code from this function.

USBD_ERR_NONE
USBD_ERR_INVALID_ARG
USBD_ERR_NULL_PTR
USBD_ERR_DEV_INVALID_NBR
USBD_ERR_DEV_INVALID_STATE
USBD_ERR_CFG_INVALID_NBR
USBD_ERR_IF_ALLOC
USBD_ERR_IF_ALT_ALLOC

RETURNED VALUE

None.

CALLERS

USB Class drivers.

NOTES / WARNINGS

Interface number, If no error(s).

USBD_IF_NBR_NONE, otherwise.

A-3-2 USBD_IF_AltAdd()

Adds an alternate setting to a specific interface.

FILES

usbd_core.h/usbd_core.c

PROTOTYPE

```
CPU_INT08U USBD_IF_AltAdd (      CPU_INT08U dev_nbr,  
                                CPU_INT08U cfg_nbr,  
                                CPU_INT08U if_nbr,  
                                const CPU_CHAR *p_name,  
                                USBD_ERR *p_err);
```

ARGUMENTS

dev_nbr Device number.

cfg_nbr Configuration number.

if_nbr Interface number.

p_name Pointer to alternate setting name.

p_err Pointer to variable that will receive the return error code from this function.

```
USB_D_ERR_NONE  
USB_D_ERR_DEV_INVALID_NBR  
USB_D_ERR_CFG_INVALID_NBR  
USB_D_ERR_IF_INVALID_NBR  
USB_D_ERR_IF_ALT_ALLOC
```

RETURNED VALUE

Interface alternate setting number, if no errors.

USB_D_IF_ALT_NBR_NONE, otherwise.

CALLERS

USB class drivers.

NOTES / WARNINGS

None.

A-3-3 USBD_IF_Grp()

Creates an interface group.

FILES

usbd_core.h/usbd_core.c

PROTOTYPE

```

CPU_INT08U USBD_IF_Grp (
    CPU_INT08U dev_nbr,
    CPU_INT08U cfg_nbr,
    CPU_INT08U class_code,
    CPU_INT08U class_sub_code,
    CPU_INT08U class_protocol_code,
    CPU_INT08U if_start,
    CPU_INT08U if_cnt,
    const CPU_CHAR *p_name,
    USBD_ERR *p_err);

```

ARGUMENTS

<code>dev_nbr</code>	Device number.
<code>cfg_nbr</code>	Configuration index to add the interface.
<code>p_class_drv</code>	Pointer to interface driver.
<code>p_class_arg</code>	Pointer to interface driver argument.
<code>class_code</code>	Class code assigned by the USB-IF.
<code>class_sub_code</code>	Subclass code assigned by the USB-IF.
<code>class_protocol_code</code>	Protocol code assigned by the USB-IF.
<code>if_start</code>	Interface number of the first interface that is associated with this group
<code>if_cnt</code>	Number of consecutive interfaces that are associated with this group.

p_err Pointer to variable that will receive the return error code from this function.

USBD_ERR_NONE
USBD_ERR_DEV_INVALID_NBR
USBD_ERR_CFG_INVALID_NBR
USBD_ERR_IF_INVALID_NBR
USBD_ERR_IF_GRP_NBR_IN_USE
USBD_ERR_IF_GRP_ALLOC

RETURNED VALUE

Interface group number, if no errors.

USBD_IF_GRP_NBR_NONE, otherwise.

CALLERS

USB class drivers.

NOTES / WARNINGS

None.

A-4 ENDPOINTS FUNCTIONS

A-4-1 USBD_CtrlTx()

Sends data on control IN endpoint.

FILES

usbd_core.h/usbd_ep.c

PROTOTYPE

```
CPU_INT32U  USBD_CtrlTx (CPU_INT08U   dev_nbr,
                        void          *p_buf,
                        CPU_INT32U   buf_len,
                        CPU_INT16U   timeout_ms,
                        CPU_BOOLEAN   end,
                        USBD_ERR      *p_err);
```

ARGUMENTS

- dev_nbr** Device number.
- p_buf** Pointer to buffer of data that will be sent
- buf_len** Number of octets to transmit.
- timeout_ms** Timeout in milliseconds.
- end** End-of-transfer flag (see Note #1).
- p_err** Pointer to variable that will receive the return error code from this function.

```
USB_D_ERR_NONE
USB_D_ERR_INVALID_ARG
USB_D_ERR_DEV_INVALID_NBR
USB_D_ERR_DEV_INVALID_STATE
USB_D_ERR_EP_INVALID_ADDR
USB_D_ERR_EP_INVALID_STATE
```

USBD_ERR_EP_INVALID_TYPE
USBD_ERR_OS_TIMEOUT
USBD_ERR_OS_ABORT
USBD_ERR_OS_FAIL

RETURNED VALUE

Number of octets transmitted, if no errors.

0, otherwise.

CALLERS

USBD_DescWrReq()
USBD_DescWrStop()
USBD_StdReqDev()
USBD_StdReqEP()
USBD_StdReqIF()
USB device class drivers

NOTES / WARNINGS

- If end-of-transfer is set and transfer length is multiple of maximum packet size, a zero-length packet is transferred to indicate a short transfer to the host.
- This function can be only called from USB device class drivers during class specific setup request callbacks.

A-4-2 USBD_CtrlRx()

Receive data on control OUT endpoint.

FILES

usbd_core.h/usbd_ep.c

PROTOTYPE

```
CPU_INT32U  USBD_CtrlRx (CPU_INT08U  dev_nbr,  
                        void          *p_buf,  
                        CPU_INT32U  buf_len,  
                        CPU_INT16U  timeout_ms,  
                        USBD_ERR     *p_err);
```

ARGUMENTS

dev_nbr Device number.

p_buf Pointer to buffer of data that will be sent

buf_len Number of octets to transmit.

timeout_ms Timeout in milliseconds.

p_err Pointer to variable that will receive the return error code from this function.

```
USB_D_ERR_NONE  
USB_D_ERR_DEV_INVALID_NBR  
USB_D_ERR_DEV_INVALID_STATE  
USB_D_ERR_EP_INVALID_ADDR  
USB_D_ERR_EP_INVALID_STATE  
USB_D_ERR_EP_INVALID_TYPE  
USB_D_ERR_OS_TIMEOUT  
USB_D_ERR_OS_ABORT  
USB_D_ERR_OS_FAIL
```

RETURNED VALUE

Number of octets received If no error(s).
0, otherwise.

CALLERS

USB device class drivers.

NOTES / WARNINGS

This function can be only called from USB device class drivers during class specific setup request callbacks.

A-4-3 USBD_BulkAdd()

Adds a bulk endpoint to alternate setting interface.

FILES

usbd_core.h/usbd_core.c

PROTOTYPE

```
CPU_INT08U  USBD_BulkAdd (CPU_INT08U  dev_nbr,
                        CPU_INT08U  cfg_nbr,
                        CPU_INT08U  if_nbr,
                        CPU_INT08U  if_alt_nbr,
                        CPU_BOOLEAN  dir_in,
                        CPU_INT16U  max_pkt_len,
                        USBD_ERR     *p_err);
```

ARGUMENTS

dev_nbr Device number.

cfg_nbr Configuration number.

if_nbr Interface number.

if_alt_nbr Interface alternate setting number.

dir_in Endpoint direction.

DEF_YES	IN direction.
DEF_NO	OUT direction.

max_pkt_len Endpoint maximum packet length (see Note #1).

p_err Pointer to variable that will receive the return error code from this function.

USBD_ERR_NONE
USBD_ERR_INVALID_ARG
USBD_ERR_DEV_INVALID_NBR
USBD_ERR_CFG_INVALID_NBR
USBD_ERR_IF_INVALID_NBR
USBD_ERR_EP_NONE_AVAIL
USBD_ERR_EP_ALLOC

RETURNED VALUE

Endpoint address, if no error(s).

USBD_EP_ADDR_NONE, otherwise.

CALLERS

USB device class drivers.

NOTES / WARNINGS

If the `max_pkt_len` argument is '0', the stack will allocate the first available bulk endpoint regardless its maximum packet size.

A-4-4 USBD_BulkRx()

Receives data on bulk OUT endpoint.

FILES

usbd_core.h/usbd_ep.c

PROTOTYPE

```
CPU_INT32U  USBD_BulkRx (CPU_INT08U  dev_nbr,
                        CPU_INT08U  ep_addr,
                        void          *p_buf,
                        CPU_INT32U  buf_len,
                        CPU_INT16U  timeout_ms,
                        USBD_ERR     *p_err);
```

ARGUMENTS

- dev_nbr** Device number.
- ep_addr** Endpoint address.
- p_buf** Pointer to destination buffer to receive data
- buf_len** Number of octets to receive.
- timeout_ms** Timeout in milliseconds.
- p_err** Pointer to variable that will receive the return error code from this function.

```
USBD_ERR_NONE
USBD_ERR_DEV_INVALID_NBR
USBD_ERR_DEVINVALID_STATE
USBD_ERR_EP_INVALID_ADDR
USBD_ERR_EP_INVALID_STATE
USBD_ERR_EP_INVALID_TYPE
USBD_ERR_OS_TIMEOUT
USBD_ERR_OS_ABORT
USBD_ERR_OS_FAIL
```

RETURNED VALUE

Number of octets received, If no error(s).
0, otherwise .

CALLERS

USB device class drivers.

NOTES / WARNINGS

This function blocks until:

- All data is received, or
- An error occurred.
- Transfer does not complete in the period specified by `timeout_ms`.

A-4-5 USBD_BulkRxAsync()

Receives data on bulk OUT endpoint asynchronously.

FILES

usbd_core.h/usbd_core.c

PROTOTYPE

```
void USBD_BulkRxAsync (CPU_INT08U      dev_nbr,
                      CPU_INT08U      ep_addr,
                      void              *p_buf,
                      CPU_INT32U      buf_len,
                      USBD_ASYNC_FNCT  async_funct,
                      void              *p_async_arg,
                      USBD_ERR         *p_err);
```

ARGUMENTS

- dev_nbr** Device number.
- ep_addr** Endpoint address.
- p_buf** Pointer to destination buffer to receive data
- buf_len** Number of octets to receive.
- async_funct** Function that will be invoked upon completion of receive operation
- p_async_arg** Pointer to argument that will be passed as parameter of **async_funct**.
- p_err** Pointer to variable that will receive the return error code from this function.

```
USB_D_ERR_NONE
USB_D_ERR_DEV_INVALID_NBR
USB_D_ERR_DEV_INVALID_STATE
USB_D_ERR_EP_INVALID_ADDR
USB_D_ERR_EP_INVALID_STATE
USB_D_ERR_EP_INVALID_TYPE
USB_D_ERR_OS_TIMEOUT
USB_D_ERR_OS_ABORT
USB_D_ERR_OS_FAIL
```

RETURNED VALUE

None.

CALLERS

USB device class drivers.

NOTES / WARNINGS

The callback specified by `async_fnct` has the following prototype.

```
void USB_AsyncFnct (CPU_INT08U dev_nbr,  
                   CPU_INT08U ep_addr,  
                   void *p_buf,  
                   CPU_INT32U buf_len,  
                   CPU_INT32U xfer_len,  
                   void *p_arg,  
                   USBD_ERR err);
```

Argument(s):

`dev_nbr` Device number.

`ep_addr` Endpoint address.

`p_buf` Pointer to destination buffer to receive data.

`buf_len` Buffer length.

`xfer_len` Number of byte received.

`p_arg` Pointer to function argument.

`err` Error status.

`USB_D_ERR_NONE`

`USB_D_ERR_EP_ABORT`

A-4-6 USBD_BulkTx()

Sends data on bulk IN endpoint.

FILES

usbd_core.h/usbd_ep.c

PROTOTYPE

```
CPU_INT32U  USBD_BulkTx (CPU_INT08U  dev_nbr,
                        CPU_INT08U  ep_addr,
                        void          *p_buf,
                        CPU_INT32U  buf_len,
                        CPU_INT16U  timeout_ms,
                        CPU_BOOLEAN  end,
                        USBD_ERR     *p_err);
```

ARGUMENTS

- dev_nbr** Device number.
- ep_addr** Endpoint address.
- p_buf** Pointer to buffer of data that will be transmitted.
- buf_len** Number of octets to transmit.
- timeout_ms** Timeout in milliseconds.
- end** End-of-transfer flag (see Note #2).
- p_err** Pointer to variable that will receive the return error code from this function.

```
USB_D_ERR_NONE
USB_D_ERR_DEV_INVALID_NBR
USB_D_ERR_DEV_INVALID_STATE
USB_D_ERR_EP_INVALID_ADDR
USB_D_ERR_EP_INVALID_STATE
USB_D_ERR_EP_INVALID_TYPE
```

USBD_ERR_OS_TIMEOUT

USBD_ERR_OS_ABORT

USBD_ERR_OS_FAIL

RETURNED VALUE

Number of octets transmitted, If no error(s).
0, otherwise.

CALLERS

USB device class drivers.

NOTES / WARNINGS

- This function blocks until:
 - All data is transmitted, or
 - An error occurred.
 - Transfer does not complete in the period specified by `timeout_ms`.
- If end-of-transfer is set and transfer length is multiple of maximum packet size, a zero-length packet is transferred to indicate a short transfer to the host.

A-4-7 USBD_BulkTxAsync()

Receives data on bulk OUT endpoint asynchronously.

FILES

usbd_core.h/usbd_core.c

PROTOTYPE

```
void USBD_BulkTxAsync (CPU_INT08U      dev_nbr,
                      CPU_INT08U      ep_addr,
                      void              *p_buf,
                      CPU_INT32U      buf_len,
                      USBD_ASYNC_FNCT  async_funct,
                      void              *p_async_arg,
                      CPU_BOOLEAN      end,
                      USBD_ERR         *p_err);
```

ARGUMENTS

dev_nbr Device number.

ep_addr Endpoint address.

p_buf Pointer to buffer of data that will be transmitted

buf_len Number of octets to transmit.

async_funct Function that will be invoked upon completion of transmit operation.

p_async_arg Pointer to argument that will be passed as parameter of **async_funct**.

end End-of-transfer flag (see Note #2).

p_err Pointer to variable that will receive the return error code from this function.

USB_ERR_NONE

USB_ERR_DEV_INVALID_NBR

USB_ERR_DEV_INVALID_STATE

```
USBD_ERR_EP_INVALID_ADDR
USBD_ERR_EP_INVALID_STATE
USBD_ERR_EP_INVALID_TYPE
USBD_ERR_OS_TIMEOUT
USBD_ERR_OS_ABORT
USBD_ERR_OS_FAIL
```

RETURNED VALUE

None.

CALLERS

USB device class drivers.

NOTES / WARNINGS

- The callback specified by `async_funct` has the following prototype.

```
void USB_AsyncFunct (CPU_INT08U dev_nbr,
                    CPU_INT08U ep_addr,
                    void *p_buf,
                    CPU_INT32U buf_len,
                    CPU_INT32U xfer_len,
                    void *p_arg,
                    USBD_ERR err);
```

Argument(s):

<code>dev_nbr</code>	Device number.
<code>ep_addr</code>	Endpoint address.
<code>p_buf</code>	Pointer to buffer of data that will be transmitted.
<code>buf_len</code>	Buffer length.
<code>xfer_len</code>	Number of byte transmitted.
<code>p_arg</code>	Pointer to function argument.

err Error status.

USBD_ERR_NONE

USBD_ERR_EP_ABORT

- If end-of-transfer is set and transfer length is multiple of maximum packet size, a zero-length packet is transferred to indicate a short transfer to the host.

A-4-8 USBD_IntrAdd()

Adds an interrupt endpoint to alternate setting interface.

FILES

usbd_core.h/usbd_core.c

PROTOTYPE

```
CPU_INT08U  USBD_IntrAdd (CPU_INT08U  dev_nbr,
                        CPU_INT08U  cfg_nbr,
                        CPU_INT08U  if_nbr,
                        CPU_INT08U  if_alt_nbr,
                        CPU_BOOLEAN  dir_in,
                        CPU_INT16U  max_pkt_len,
                        CPU_INT16U  interval,
                        USBD_ERR     *p_err);
```

ARGUMENTS

dev_nbr Device number.

cfg_nbr Configuration number.

if_nbr Interface number.

if_alt_nbr Interface alternate setting number.

dir_in Endpoint direction.

DEF_YES IN direction.

DEF_NO OUT direction.

max_pkt_len Endpoint maximum packet length (see Note #1).

interval Endpoint interval in frames/microframes.

p_err Pointer to variable that will receive the return error code from this function.

USBD_ERR_NONE
USBD_ERR_INVALID_ARG
USBD_ERR_DEV_INVALID_NBR
USBD_ERR_CFG_INVALID_NBR
USBD_ERR_IF_INVALID_NBR
USBD_ERR_EP_NONE_AVAIL
USBD_ERR_EP_ALLOC

RETURNED VALUE

Endpoint address, If no error(s).

USBD_EP_ADDR_NONE, otherwise .

CALLERS

USB device class drivers.

NOTES / WARNINGS

If the `max_pkt_len` argument is '0', the stack will allocate the first available interrupt endpoint regardless its maximum packet size.

A-4-9 USBD_IntrRx()

Receives data on interrupt OUT endpoint.

FILES

usbd_core.h/usbd_ep.c

PROTOTYPE

```
CPU_INT32U  USBD_IntrRx (CPU_INT08U  dev_nbr,
                        CPU_INT08U  ep_addr,
                        void          *p_buf,
                        CPU_INT32U  buf_len,
                        CPU_INT16U  timeout_ms,
                        USBD_ERR     *p_err);
```

ARGUMENTS

- dev_nbr** Device number.
- ep_addr** Endpoint address.
- p_buf** Pointer to destination buffer to receive data
- buf_len** Number of octets to receive.
- timeout_ms** Timeout in milliseconds.
- p_err** Pointer to variable that will receive the return error code from this function.

```
USBD_ERR_NONE
USBD_ERR_DEV_INVALID_NBR
USBD_ERR_DEVINVALID_STATE
USBD_ERR_EP_INVALID_ADDR
USBD_ERR_EP_INVALID_STATE
USBD_ERR_EP_INVALID_TYPE
USBD_ERR_OS_TIMEOUT
USBD_ERR_OS_ABORT
USBD_ERR_OS_FAIL
```

RETURNED VALUE

Number of octets received, If no error(s).
0, otherwise .

CALLERS

USB device class drivers.

NOTES / WARNINGS

This function blocks until:

- All data is received, or
- An error occurred.
- Transfer does not complete in the period specified by `timeout_ms`.

A-4-10 USBD_IntrRxAsync()

Receives data on interrupt OUT endpoint asynchronously.

FILES

usbd_core.h/usbd_core.c

PROTOTYPE

```
void USBD_IntrRxAsync (CPU_INT08U      dev_nbr,
                      CPU_INT08U      ep_addr,
                      void             *p_buf,
                      CPU_INT32U      buf_len,
                      USBD_ASYNC_FNCT async_funct,
                      void             *p_async_arg,
                      USBD_ERR        *p_err);
```

ARGUMENTS

- dev_nbr** Device number.
- ep_addr** Endpoint address.
- p_buf** Pointer to destination buffer to receive data
- buf_len** Number of octets to receive.
- async_funct** Function that will be invoked upon completion of receive operation
- p_async_arg** Pointer to argument that will be passed as parameter of **async_funct**.
- p_err** Pointer to variable that will receive the return error code from this function.

```
USB_D_ERR_NONE
USB_D_ERR_DEV_INVALID_NBR
USB_D_ERR_DEV_INVALID_STATE
USB_D_ERR_EP_INVALID_ADDR
USB_D_ERR_EP_INVALID_STATE
USB_D_ERR_EP_INVALID_TYPE
USB_D_ERR_OS_TIMEOUT
USB_D_ERR_OS_ABORT
USB_D_ERR_OS_FAIL
```

RETURNED VALUE

None.

CALLERS

USB device class drivers.

NOTES / WARNINGS

The callback specified by `async_fnct` has the following prototype.

```
void USB_AsyncFnct (CPU_INT08U dev_nbr,  
                  CPU_INT08U ep_addr,  
                  void *p_buf,  
                  CPU_INT32U buf_len,  
                  CPU_INT32U xfer_len,  
                  void *p_arg,  
                  USB_ERR err);
```

Argument(s):

`dev_nbr` Device number.

`ep_addr` Endpoint address.

`p_buf` Pointer to destination buffer to receive data.

`buf_len` Buffer length.

`xfer_len` Number of byte received.

`p_arg` Pointer to function argument.

`err` Error status.

```
USB_ERR_NONE  
USB_ERR_EP_ABORT
```

A-4-11 USBD_IntrTx()

Sends data on interrupt IN endpoint.

FILES

usbd_core.h/usbd_ep.c

PROTOTYPE

```
CPU_INT32U  USBD_IntrTx (CPU_INT08U  dev_nbr,
                        CPU_INT08U  ep_addr,
                        void          *p_buf,
                        CPU_INT32U  buf_len,
                        CPU_INT16U  timeout_ms,
                        CPU_BOOLEAN  end,
                        USBD_ERR     *p_err);
```

ARGUMENTS

- dev_nbr** Device number.
- ep_addr** Endpoint address.
- p_buf** Pointer to buffer of data that will be transmitted.
- buf_len** Number of octets to transmit.
- timeout_ms** Timeout in milliseconds.
- end** End-of-transfer flag (see Note #2).
- p_err** Pointer to variable that will receive the return error code from this function.

```
USB_D_ERR_NONE
USB_D_ERR_DEV_INVALID_NBR
USB_D_ERR_DEV_INVALID_STATE
USB_D_ERR_EP_INVALID_ADDR
USB_D_ERR_EP_INVALID_STATE
USB_D_ERR_EP_INVALID_TYPE
```

USBD_ERR_OS_TIMEOUT
USBD_ERR_OS_ABORT
USBD_ERR_OS_FAIL

RETURNED VALUE

Number of octets transmitted, If no error(s).
0, otherwise.

CALLERS

USB device class drivers.

NOTES / WARNINGS

- This function blocks until:
 - All data is transmitted, or
 - An error occurred.
 - Transfer does not complete in the period specified by `timeout_ms`.
- If end-of-transfer is set and transfer length is multiple of maximum packet size, a zero-length packet is transferred to indicate a short transfer to the host.

A-4-12 USBD_IntrTxAsync()

Receives data on interrupt OUT endpoint asynchronously.

FILES

usbd_core.h/usbd_core.c

PROTOTYPE

```
void USBD_IntrTxAsync (CPU_INT08U      dev_nbr,
                      CPU_INT08U      ep_addr,
                      void              *p_buf,
                      CPU_INT32U      buf_len,
                      USBD_ASYNC_FNCT  async_fnct,
                      void              *p_async_arg,
                      CPU_BOOLEAN      end,
                      USBD_ERR         *p_err);
```

ARGUMENTS

- dev_nbr** Device number.
- ep_addr** Endpoint address.
- p_buf** Pointer to buffer of data that will be transmitted
- buf_len** Number of octets to transmit.
- async_fnct** Function that will be invoked upon completion of transmit operation.
- p_async_arg** Pointer to argument that will be passed as parameter of **async_fnct**.
- end** End-of-transfer flag (see Note #2).
- p_err** Pointer to variable that will receive the return error code from this function.
- USB_ERR_NONE
 USB_ERR_DEV_INVALID_NBR
 USB_ERR_DEV_INVALID_STATE

```
USBD_ERR_EP_INVALID_ADDR
USBD_ERR_EP_INVALID_STATE
USBD_ERR_EP_INVALID_TYPE
USBD_ERR_OS_TIMEOUT
USBD_ERR_OS_ABORT
USBD_ERR_OS_FAIL
```

RETURNED VALUE

None.

CALLERS

USB device class drivers.

NOTES / WARNINGS

- The callback specified by `async_fnct` has the following prototype.

```
void USB_AsyncFunct (CPU_INT08U dev_nbr,
                    CPU_INT08U ep_addr,
                    void *p_buf,
                    CPU_INT32U buf_len,
                    CPU_INT32U xfer_len,
                    void *p_arg,
                    USBD_ERR err);
```

Argument(s):

`dev_nbr` Device number.

`ep_addr` Endpoint address.

`p_buf` Pointer to buffer of data that will be transmitted.

`buf_len` Buffer length.

`xfer_len` Number of byte transmitted.

`p_arg` Pointer to function argument.

err Error status.

USBD_ERR_NONE

USBD_ERR_EP_ABORT

- If end-of-transfer is set and transfer length is multiple of maximum packet size, a zero-length packet is transferred to indicate a short transfer to the host.

A-4-13 USBD_EP_RxZLP()

Receives zero-length packet from the host.

FILES

usbd_core.h/usbd_ep.c

PROTOTYPE

```
void USBD_EP_RxZLP (CPU_INT08U dev_nbr,  
                   CPU_INT08U ep_addr,  
                   CPU_INT16U timeout_ms,  
                   USBD_ERR *p_err);
```

ARGUMENTS

dev_nbr Pointer to USB device driver structure.

ep_addr Pointer to buffer of data that will be transmitted.

timeout_ms Timeout in milliseconds.

p_err Pointer to variable that will receive the return error code from this function.

```
USB_ERR_OS_NONE  
USB_ERR_DEV_INVALID_NBR  
USB_ERR_EP_INVALID_ADDR  
USB_ERR_EP_INVALID_STATE  
USB_ERR_OS_TIMEOUT  
USB_ERR_OS_ABORT  
USB_ERR_OS_FAIL
```

RETURNED VALUE

None.

CALLERS

USBD_CtrlRx()

USBD_CtrlRxStatus()

USB device class drivers.

NOTES / WARNINGS

None.

A-4-14 USBD_EP_TxZLP()

Sends zero-length packet from the host.

FILES

usbd_core.h/usbd_ep.c

PROTOTYPE

```
void USBD_EP_RxZLP (CPU_INT08U dev_nbr,  
                   CPU_INT08U ep_addr,  
                   CPU_INT16U timeout_ms,  
                   USBD_ERR *p_err);
```

ARGUMENTS

dev_nbr Pointer to USB device driver structure.

ep_addr Pointer to buffer of data that will be transmitted.

timeout_ms Timeout in milliseconds.

p_err Pointer to variable that will receive the return error code from this function.

```
USB_ERR_OS_NONE  
USB_ERR_DEV_INVALID_NBR  
USB_ERR_EP_INVALID_ADDR  
USB_ERR_EP_INVALID_STATE  
USB_ERR_OS_TIMEOUT  
USB_ERR_OS_ABORT  
USB_ERR_OS_FAIL
```

RETURNED VALUE

None.

CALLERS

USB_D_CtrlTxStatus()
USB device class drivers.

NOTES / WARNINGS

None.

A-4-15 USBD_EP_Abort()

Abort I/O transfer on endpoint.

FILES

usb_core.h/usb_ep.c

PROTOTYPE

```
void USBD_EP_Abort (CPU_INT08U dev_nbr,  
                  CPU_INT08U ep_addr,  
                  USBD_ERR *p_err);
```

ARGUMENTS

dev_nbr Device number.

ep_addr Endpoint address.

p_err Pointer to variable that will receive the return error code from this function.

USB_ERR_NONE
USB_ERR_DEV_INVALID_NBR
USB_ERR_EP_INVALID_ADDR
USB_ERR_EP_INVALID_STATE
USB_ERR_EP_ABORT
USB_ERR_EP_OS_FAIL

RETURNED VALUE

None.

CALLERS

USB_EP_Stall()

USB device class drivers.

NOTES / WARNINGS

None.

A-4-16 USBD_EP_Stall()

Modify stall state condition on non-control endpoints.

FILES

usbd_core.h/usbd_ep.c

PROTOTYPE

```
void USBD_EP_Stall (CPU_INT08U   dev_nbr,
                   CPU_INT08U   ep_addr,
                   CPU_BOOLEAN  state,
                   USBD_ERR      *p_err)
```

ARGUMENTS

dev_nbr Device number.

ep_addr Line control change notification callback (see note #1).

state Endpoint stall state.

DEF_SET Set stall condition.

DEF_NO Clear stall condition.

p_err Pointer to variable that will receive the return error code from this function.

USB_ERR_NONE

USB_ERR_DEV_INVALID_ARG

USB_ERR_EP_INVALID_ADDR

USB_ERR_EP_INVALID_STATE

USB_ERR_EP_STALL

USB_ERR_EP_ABORT

USB_ERR_OS_FAIL

RETURNED VALUE

None.

CALLERS

USB_D_EP_Close()

USB_D_StdReqEP()

USB device class drivers.

NOTES / WARNINGS

None.

A-4-17 USBD_EP_IsStalled()

Gets stall status of non-control endpoint

FILES

usbd_core.h/usbd_ep.c

PROTOTYPE

```
CPU_BOOLEAN USBD_EP_IsStalled (CPU_INT08U dev_nbr,
                                CPU_INT08U ep_addr,
                                USBD_ERR *p_err);
```

ARGUMENTS

dev_nbr Device number.

ep_addr Pointer to the structure where the current line coding will be stored.

p_err Pointer to variable that will receive the return error code from this function.

USB_ERR_NONE

USB_ERR_DEV_INVALID_ARG

USB_ERR_EP_INVALID_ADDR

RETURNED VALUE

DEF_TRUE, if endpoint is stalled.

DEF_FALSE, otherwise .

CALLERS

USBD_StdReqEP()

USB device class drivers.

Application.

NOTES / WARNINGS

None.

A-4-18 USBD_EP_GetMaxPktSize()

Retrieves endpoint's maximum packet size

FILES

usbd_core.h/usbd_ep.c

PROTOTYPE

```
CPU_INT16U USBD_EP_GetMaxPktSize (CPU_INT08U dev_nbr,  
                                   CPU_INT08U ep_addr,  
                                   USBD_ERR *p_err);
```

ARGUMENTS

dev_nbr Device number.

ep_addr Endpoint address.

p_err Pointer to variable that will receive the return error code from this function.

```
USB_ERR_NONE  
USB_ERR_DEV_INVALID_NBR  
USB_ERR_EP_INVALID_ADDR  
USB_ERR_EP_INVALID_STATE
```

RETURNED VALUE

Maximum packet size, If no error(s).

0, otherwise.

CALLERS

Application.

NOTES / WARNINGS

None.

A-4-19 USBD_EP_GetMaxPhyNbr()

Get the maximum physical endpoint number.

FILES

usbd_core.h/usbd_ep.c

PROTOTYPE

```
CPU_INT08U USBD_EP_GetMaxPhyNbr (CPU_INT08U dev_nbr)
```

ARGUMENTS

dev_nbr Device number.

RETURNED VALUE

Maximum physical endpoint number, If no error(s).

USB_EP_PHY_NONE, otherwise .

CALLERS

USB device controllers drivers.

Application.

NOTES / WARNINGS

None.

A-4-20 USBD_EP_GetMaxNbrOpen()

Retrieve maximum number of opened endpoints

FILES

usbd_core.h/usbd_ep.c

PROTOTYPE

```
CPU_INT08U USBD_EP_GetMaxNbrOpen (CPU_INT08U dev_nbr);
```

ARGUMENTS

dev_nbr Device number.

RETURNED VALUE

Maximum number of opened endpoints, If no errors.
0, otherwise.

CALLERS

USB device controllers drivers.

Application.

NOTES / WARNINGS

None.

A-5 CORE OS FUNCTIONS

A-5-1 USBD_OS_Init()

Initialize USB RTOS layer internal objects.

FILES

usbd_internal.h/usbd_os.c

PROTOTYPE

```
void USBD_OS_Init (USB_ERR *p_err);
```

ARGUMENTS

p_err Pointer to variable that will receive the return error code from this function.

RETURNED VALUE

None.

CALLERS

USB_Init()

IMPLEMENTATION GUIDELINES

- The followings RTOS resources are required by the stack and should be allocated in when this function is called.
 - One task for core and asynchronous events.
 - One queue that can hold up to `USB_CORE_EVENT_NBR_TOTAL` events.
 - `USB_CFG_MAX_NBR_DEV` x `USB_CFG_MAX_NBR_EP_OPEN` semaphores for endpoints operations.

-
- If tracing is enabled, a semaphore and a task to manage debug events allocation and debug events processing respectively.

If any error happen, `USBD_ERR_OS_INIT_FAIL` should be assigned to `p_err` and the function should return immediately. Otherwise, `USBD_ERR_NONE` should be assigned to `p_err`.

A-5-2 USBD_CoreTaskHandler()

Process all core events and operations.

FILES

usbd_internal.h/usbd_core.c

PROTOTYPE

```
void USBD_CoreTaskHandler (void);
```

ARGUMENTS

None.

RETURNED VALUE

None.

CALLERS

USB RTOS layer.

IMPLEMENTATION GUIDELINES

Typically, the RTOS layer should create a shell task for core events. The primary purpose of the shell task is to run `USBD_CoreTaskHandler()`.

A-5-3 USBD_DbgTaskHandler()

Process all pending debug events generated by the core.

FILES

usbd_internal.h/usbd_core.c

PROTOTYPE

```
void USBD_DbgTaskHandler (void);
```

ARGUMENTS

None.

RETURNED VALUE

None.

CALLERS

USB RTOS layer.

IMPLEMENTATION GUIDELINES

- Typically, the RTOS layer code should create a shell task to process debug events generated by the core. The primary purpose of the shell task is to run `USBD_DbgTaskHandler()`.
- This function is only present in the code if trace option is enabled in the stack.

A-5-4 USBD_OS_EP_SignalCreate()

Creates a signal/semaphore for endpoints operations.

FILES

usbd_internal.h/usbd_os.c

PROTOTYPE

```
void USBD_OS_EP_SignalCreate (CPU_INT08U dev_nbr,  
                             CPU_INT08U ep_ix,  
                             USBD_ERR *p_err);
```

ARGUMENTS

dev_nbr Device number.

ep_ix Endpoint index.

p_err Pointer to variable that will receive the return error code from this function.

RETURNED VALUE

None.

CALLERS

Endpoints open functions.

IMPLEMENTATION GUIDELINES

- The purpose of this function is to allocate a signal or a semaphore for the specified endpoint.

-
- Typically, the RTOS layer code should create a two-dimensional array to store the signals/semaphores handlers. The `dev_nbr` and `ep_ix` are used to index this array.
 - `dev_nbr` ranges between 0 and `USBD_CFG_MAX_NBR_DEV`.
 - `ep_ix` ranges between 0 and `USBD_CFG_MAX_NBR_EP_OPEN`.
 - In case the creation fails, `USBD_ERR_OS_SIGNAL_CREATE` should be assigned to `p_err`. Otherwise, `USBD_ERR_NONE` should be assigned to `p_err`.

A-5-5 USBD_OS_EP_SignalDel()

Deletes a signal/semaphore.

FILES

usbd_internal.h/usbd_os.c

PROTOTYPE

```
void USBD_OS_EP_SignalDel (CPU_INT08U dev_nbr,  
                           CPU_INT08U ep_ix);
```

ARGUMENTS

dev_nbr Device number.

ep_ix Endpoint index.

RETURNED VALUE

None.

CALLERS

Endpoints close functions.

IMPLEMENTATION GUIDELINES

A call to this function should delete the signal / semaphore associated to the specified endpoint.

A-5-6 USBD_OS_EP_SignalPend()

Waits for a signal/semaphore to become available.

FILES

usbd_internal.h/usbd_os.c

PROTOTYPE

```
void USBD_OS_EP_SignalPend (CPU_INT08U dev_nbr,  
                             CPU_INT08U ep_ix,  
                             CPU_INT16U timeout_ms,  
                             USBD_ERR *p_err);
```

ARGUMENTS

dev_nbr Device number.

ep_ix Endpoint index.

timeout_ms Timeout in milliseconds.

p_err Pointer to variable that will receive the return error code from this function.

RETURNED VALUE

None.

CALLERS

Endpoints Rx/Tx functions.

IMPLEMENTATION GUIDELINES

A call to this function should pend on the signal / semaphore associated to the specified endpoint.

Table A-1 describes the error codes that should be assigned to **p_err** depending on the operation result.

Appendix A

Operation result	Error code
No error.	USB_ERR_NONE
Pend timeout	USB_ERR_OS_TIMEOUT
Pend aborted	USB_ERR_OS_ABORT
Pend failed for any other reason	USB_ERR_OS_FAIL

Table A-1 **p_err** assignment in function of operation result.

A-5-7 USBD_OS_EP_SignalAbort()

Aborts any wait operation on signal/semaphore.

FILES

usbd_internal.h/usbd_os.c

PROTOTYPE

```
void USBD_OS_EP_SignalAbort (CPU_INT08U dev_nbr,  
                             CPU_INT08U ep_ix,  
                             USBD_ERR *p_err);
```

ARGUMENTS

dev_nbr Device number.

ep_ix Endpoint index.

p_err Pointer to variable that will receive the return error code from this function.

RETURNED VALUE

None.

CALLERS

Endpoints abort functions.

IMPLEMENTATION GUIDELINES

This function should abort all pend operations performed on the signal / semaphore associated to the specified endpoint.

If any error happen, `USB_ERR_OS_FAIL` should be assigned to `p_err`. Otherwise, `USB_ERR_NONE` should be assigned to `p_err`.

A-5-8 USBD_OS_EP_SignalPost()

Makes a signal/semaphore available.

FILES

usbd_internal.h/usbd_os.c

PROTOTYPE

```
void USBD_OS_EP_SignalPost (CPU_INT08U dev_nbr,  
                             CPU_INT08U ep_ix,  
                             USBD_ERR *p_err);
```

ARGUMENTS

dev_nbr Device number.

ep_ix Endpoint index.

p_err Pointer to variable that will receive the return error code from this function.

RETURNED VALUE

None.

CALLERS

Endpoints transfer complete functions.

IMPLEMENTATION GUIDELINES

A call to this function should post the signal / semaphore associated to the specified endpoint.

In case the post fail, `USB_ERR_OS_FAIL` should be assigned to `p_err`. Otherwise, `USB_ERR_NONE` should be assigned to `p_err`.

A-5-9 USBD_OS_CoreEventPut()

Queues a core event.

FILES

usbd_internal.h/usbd_os.c

PROTOTYPE

```
void USBD_OS_CoreEventPut (void *p_event);
```

ARGUMENTS

p_event Pointer to core event.

RETURNED VALUE

None.

CALLERS

Endpoints and bus event handlers.

IMPLEMENTATION GUIDELINES

A call to this function should add the passed event to the core events queue.

A-5-10 USBD_OS_CoreEventGet()

Wait until a core event is ready.

FILES

usbd_internal.h/usbd_os.c

PROTOTYPE

```
void *USB_D_OS_CoreEventGet (CPU_INT32U timeout_ms,  
                             USB_D_ERR *p_err);
```

ARGUMENTS

timeout_ms Timeout in milliseconds.

p_err Pointer to variable that will receive the return error code from this function.

RETURNED VALUE

Pointer to core event, if no errors.

Null pointer, otherwise.

CALLERS

USB_D_CoreTaskHandler()

IMPLEMENTATION GUIDELINES

A call to this function should block until an event is added to queue and return it.

Table A-1 describes the error codes that should be assigned to **p_err** depending on the operation result.

A-5-11 USBD_OS_DbgEventRdy()

Signals debug event handler task.

FILES

usb_internal.h/usb_os.c

PROTOTYPE

```
void USBD_OS_DbgEventRdy (void);
```

ARGUMENTS

None.

RETURNED VALUE

None.

CALLERS

Debug functions.

IMPLEMENTATION GUIDELINES

A call to this function should post the signal / semaphore that resume the debug task.

A-5-12 USBD_OS_DbgEventWait ()

Waits until a trace event is available.

FILES

usbd_internal.h/usbd_os.c

PROTOTYPE

```
void USBD_OS_DbgEventWait (void);
```

ARGUMENTS

None.

RETURNED VALUE

None.

CALLERS

USBD_DbgTaskHandler()

IMPLEMENTATION GUIDELINES

A call to this function should pend on the signal / semaphore that resume the debug task.

A-6 DEVICE DRIVERS CALLBACKS FUNCTIONS

A-6-1 USBD_EP_RxCmpl()

Notifies the stack that an OUT transfer is completed.

FILES

usbd_core.h/usbd_ep.c

PROTOTYPE

```
void USBD_EP_RxCmpl (USBDRV *p_drv,  
                    CPU_INT08U ep_log_nbr);
```

ARGUMENTS

p_drv Pointer to device driver structure.

ep_log_nbr Endpoint logical number.

RETURNED VALUE

None.

CALLERS

USB device controller drivers ISR

NOTES / WARNINGS

None.

A-6-2 USBD_EP_TxCmpl()

Notifies the stack that an IN transfer is completed.

FILES

usbd_core.h/usbd_ep.c

PROTOTYPE

```
void USBD_EP_RxCmpl (USBDRV *p_drv,  
                    CPU_INT08U ep_log_nbr);
```

ARGUMENTS

p_drv Pointer to device driver structure.

ep_log_nbr Endpoint logical number.

RETURNED VALUE

None.

CALLERS

USB device controller drivers ISR

NOTES / WARNINGS

None.

A-6-3 USBD_EventConn()

Notifies the stack the device is connected to the host.

FILES

usbd_core.h/usbd_core.c

PROTOTYPE

```
void USBD_EventConn (USBDRV *p_drv);
```

ARGUMENTS

p_drv Pointer to device driver structure.

RETURNED VALUE

None.

CALLERS

USB device controller drivers ISR

NOTES / WARNINGS

None.

A-6-4 USBD_EventDisconnect()

Notifies the stack the device is disconnect from the host..

FILES

usb_core.h/usb_core.c

PROTOTYPE

```
void USBD_EventDisconnect (USBDRV *p_drv);
```

ARGUMENTS

p_drv Pointer to device driver structure.

RETURNED VALUE

None.

CALLERS

USB device controller drivers ISR

NOTES / WARNINGS

None.

A-6-5 USBD_EventReset()

Notifies the stack a reset event in the bus.

FILES

usbd_core.h/usbd_core.c

PROTOTYPE

```
void USBD_EventReset(USBDRV *p_drv);
```

ARGUMENTS

p_drv Pointer to device driver structure.

RETURNED VALUE

None.

CALLERS

USB device controller drivers ISR

NOTES / WARNINGS

None.

A-6-6 USBD_EventHS()

This function notifies the stack that a host is high speed capable.

FILES

usbd_core.h/usbd_core.c

PROTOTYPE

```
void USBD_EventHS(USBDRV *p_drv);
```

ARGUMENTS

p_drv Pointer to device driver structure.

RETURNED VALUE

None.

CALLERS

USB device controller drivers ISR

NOTES / WARNINGS

None.

A-6-7 USBD_EventSuspend()

Notifies the stack a suspend event in the bus.

FILES

usbd_core.h/usbd_core.c

PROTOTYPE

```
void USBD_EventSuspend (USBDRV *p_drv);
```

ARGUMENTS

p_drv Pointer to device driver structure.

RETURNED VALUE

None.

CALLERS

USB device controller drivers ISR

NOTES / WARNINGS

None.

A-6-8 USBD_EventResume()

Notifies the stack a resume event in the bus.

FILES

usbd_core.h/usbd_core.c

PROTOTYPE

```
void USBD_EventResume (USBDRV *p_drv);
```

ARGUMENTS

p_drv Pointer to device driver structure.

RETURNED VALUE

None.

CALLERS

USB device controller drivers ISR

NOTES / WARNINGS

None.

A-7 TRACE FUNCTIONS

A-7-1 USBD_Trace()

Outputs debug information from the core. Users must implement this function if trace functionality is enabled (`USB_CFG_DBG_TRACE` is defined to `DEF_ENABLED`).

FILES

`usbd_core.h`

PROTOTYPE

```
void USBD_Trace (const CPU_CHAR *p_str);
```

ARGUMENTS

`p_drv` Pointer to the string containing debug information.

RETURNED VALUE

None.

CALLERS

USB core debug task handler.

NOTES / WARNINGS

None.

Appendix A

B

Device Controller Driver API Reference

This appendix provides a reference to the Device Controller Driver API. Each user-accessible service is presented in alphabetical order. The following information is provided for each of the services:

- A brief description
- The function prototype
- The filename of the source code
- A description of the arguments passed to the function
- A description of returned value(s)
- Specific notes and warnings regarding use of the service

B-1 DEVICE DRIVER FUNCTIONS

B-1-1 USB_DrvInit()

The first function within the Device Driver API is the device driver initialization/`Init()` function. This function is called by `USBD_DevStart()` exactly once for each specific device added by the application. If multiple instances of the same device are present on the development board, then this function is called for each instance of the device. However, applications should not try to add the same specific device more than once. If a device fails to initialize, it is recommend debugging to find and correct the cause of failure.

Note: This function relies heavily on the implementation of several device board support package (BSP) functions. See section B-2 “Device Driver BSP Functions” on page 350 for more information on device BSP functions.

FILES

Every device driver's `usbd_drv.c`

PROTOTYPE

```
static void USB_DrvInit (USBD_DRV *p_drv
                        USBD_ERR *p_err);
```

Note that since every device driver function is accessed only by function pointer via the device driver's API structure, they do not need to be globally available and should therefore be declared as `'static'`.

ARGUMENTS

`p_drv` Pointer to USB device driver structure.

`p_err` Pointer to variable that will receive the return error code from this function.

RETURNED VALUE

None.

CALLERS

USBDevInit() via 'p_drv_api->Init()'.

NOTES / WARNINGS

The `Init()` function generally performs the following operations, however, depending on the device being initialized, functionality may need to be added or removed:

- Configure clock gating to the USB device, configure all necessary I/O pins, and configure the host interrupt controller. This is generally performed via the device's BSP function pointer, `Init()`, implemented in `usbdrv_bsp.c` (see section B-2-1 "USBDRV_BSP_Init()" on page 350).
- Reset USB controller or USB controller registers.
- Disable and clear pending interrupts (should already be cleared).
- Set the device address to zero.
- For DMA devices: Allocate memory for all necessary descriptors. This is performed via calls to `uC/LIB's` memory module. If memory allocation fails, set `p_err` to `USBDRV_ERR_ALLOC` and return.
- Set `p_err` to `USBDRV_ERR_NONE` if initialization proceeded as expected. Otherwise, set `p_err` to an appropriate device error code.

B-1-2 USB_DrvStart()

The second function is the device driver **Start()** function. This function is called once each time a device is started.

FILES

Every device driver's `usbd_drv.c`

PROTOTYPE

```
static void USB_DrvStart (USB_DRV *p_drv
                        USB_ERR *p_err);
```

ARGUMENTS

`p_drv` Pointer to USB device driver structure.

`p_err` Pointer to variable that will receive the return error code from this function.

RETURNED VALUE

None.

CALLERS

`USB_DevStart()` via `'p_drv_api->Start()'`.

NOTES / WARNINGS

The **Start()** function performs the following items:

- Typically, activates the pull-up on the D+ pin to simulate attachment to host. Some MCUs/MPUs have an internal pull-up that is activated by a device controller register; for others, this may be a general purpose I/O pin. This is generally performed via the device's BSP function pointer, `Conn()`, implemented in `usbd_bsp.c` (see section B-2-2 on page 351). The device's BSP `Conn()` is also responsible for enabling the host interrupt controller.
- Clear all interrupt flags.

-
- Locally enable interrupts on the hardware device. The host interrupt controller should have already been configured within the device driver `Init()` function.
 - Enable the controller.
 - Set `p_err` equal to `USBD_ERR_NONE` if no errors have occurred. Otherwise, set `p_err` to an appropriate device error code.

B-1-3 USB_DrvStop()

The next function within the device API structure is the device `Stop()` function. This function is called once each time a device is stopped.

FILES

Every device driver's `usbdrv.c`

PROTOTYPE

```
static void USB_DrvStop (USB_DRV *p_drv);
```

ARGUMENTS

`p_drv` Pointer to USB device driver structure.

RETURNED VALUE

None.

CALLERS

`USB_DevStop()` via '`p_drv_api->Stop()`'.

NOTES / WARNINGS

Typically, the `Stop()` function performs the following operations:

- Disable the controller.
- Clear and locally disable interrupts on the hardware device.
- Disconnect from the USB host (e.g, reset the pull-up on the D+ pin). This is generally performed via the device's BSP function pointer, `Disconn()`, implemented in `usbdrv.c` (see section B-2-3 on page 352).

B-1-4 USBD_DrvAddrSet()

The next API function to implement is the device address set/`AddrSet()` function. The device address set function is called while processing a `SET_ADDRESS` setup request.

FILES

Every device driver's `usbdrv.c`

PROTOTYPE

```
static CPU_BOOLEAN USBD_DrvAddrSet (USB_DRV    *p_drv,  
                                     CPU_INT08U  dev_addr);
```

ARGUMENTS

`p_drv` Pointer to USB device driver structure.

`dev_addr` Device address assigned by the host.

RETURNED VALUE

`DEF_OK`, if NO error(s).

`DEF_FAIL`, otherwise.

CALLERS

`USBStdReqDev()` via '`p_drv_api->AddrSet()`'.

NOTES / WARNINGS

- For device controllers that have hardware assistance to enable the device address after the status stage has completed, the assignment of the device address can also be combined with enabling the device address mode.
- For device controllers that change the device address immediately, without waiting the status phase to complete, see `USB_DrvAddrEn()`.

B-1-5 USB_DrvAddrEn()

The next function in the device API structure is the device address enable/**AddrEn()** function.

FILES

Every device driver's `usbdrv.c`

PROTOTYPE

```
static CPU_BOOLEAN USB_DrvAddrEn (USB_DRV *p_drv
                                   CPU_INT08U dev_addr);
```

ARGUMENTS

p_drv Pointer to USB device driver structure.
dev_addr Device address assigned by the host.

RETURNED VALUE

None.

CALLERS

`USB_StdReqHandler()` via '`p_drv_api->AddrEn()`'.

NOTES / WARNINGS

- For device controllers that have hardware assistance to enable the device address after the status stage has completed, no operation needs to be performed.
- For device controllers that change the device address immediately, without waiting the status phase to complete, the device address must be set and enabled.

B-1-6 USBD_DrvCfgSet()

Bring device into configured state.

FILES

Every device driver's `usbdrv.c`

PROTOTYPE

```
static CPU_BOOLEAN USBD_DrvCfgSet (USBDRV *p_drv,  
                                   CPU_INT08U cfg_val);
```

ARGUMENTS

`p_drv` Pointer to USB device driver structure.

`cfg_val` Configuration value.

RETURNED VALUE

`DEF_OK`, if NO error(s).

`DEF_FAIL`, otherwise.

CALLERS

`USB_DrvCfgOpen()` via '`p_drv_api->CfgSet()`'.

NOTES / WARNINGS

Typically, the set configuration function sets the device as configured. For some controllers, this may not be necessary.

B-1-7 USBD_DrvCfgClr()

Bring device into de-configured state.

FILES

Every device driver's `usbd_drv.c`

PROTOTYPE

```
static void USBD_DrvCfgClr (USBDRV *p_drv,  
                           CPU_INT08U cfg_val);
```

ARGUMENTS

`p_drv` Pointer to USB device driver structure.

`cfg_val` Configuration value.

RETURNED VALUE

None.

CALLERS

`USBDRV_CfgClose()` via `'p_drv_api->CfgClr()'`.

NOTES / WARNINGS

- Typically, the clear configuration function sets the device as not being configured. For some controllers, this may not be necessary.
- This functions in invoked after a bus reset or before the status stage of some `SET_CONFIGURATION` requests.

B-1-8 USB_DrvGetFrameNbr()

Retrieve current frame number.

FILES

Every device driver's `usbdrv.c`

PROTOTYPE

```
static CPU_INT16U USB_DrvGetFrameNbr (USB_DRV *p_drv);
```

ARGUMENTS

`p_drv` Pointer to USB device driver structure.

RETURNED VALUE

Frame number.

CALLERS

None.

NOTES / WARNINGS

None.

B-1-9 USBD_DrvEP_Open()

Open and configure a device endpoint, given its characteristics (e.g., endpoint type, endpoint address, maximum packet size, etc).

FILES

Every device driver's `usbd_drv.c`

PROTOTYPE

```
static void USBD_DrvEP_Open (USBDEV *p_drv,  
                             CPU_INT08U ep_addr,  
                             CPU_INT08U ep_type,  
                             CPU_INT16U max_pkt_size,  
                             CPU_INT08U transaction_frame,  
                             USBDEV_ERR *p_err);
```

ARGUMENTS

`p_drv` Pointer to USB device driver structure.

`ep_addr` Endpoint address.

`ep_type` Endpoint type:

```
USB_EP_TYPE_CTRL,  
USB_EP_TYPE_ISOC,  
USB_EP_TYPE_BULK,  
USB_EP_TYPE_INTR.
```

`max_pkt_size` Maximum packet size.

`transaction_frame` Endpoint transactions per frame.

`p_err` Pointer to variable that will receive the return error code from this function.

RETURNED VALUE

None.

CALLERS

- `USB_Driver->EP_Open()` via `'p_drv_api->EP_Open()'`
- `USB_Driver->CtrlOpen()`

NOTES / WARNINGS

- Typically, the endpoint open function performs the following operations:
 - Validate endpoint address, type and maximum packet size.
 - Configure endpoint information in the device controller. This may include not only assigning the type and maximum packet size, but also making certain that the endpoint is successfully configured (or *realized* or *mapped*). For some device controllers, this may not be necessary.
- If the endpoint address is valid, then the endpoint open function should validate the attributes allowed by the hardware endpoint.
 - `max_pkt_size` is the maximum packet size the endpoint can send or receive. The endpoint open function should validate the maximum packet size to match hardware capabilities.

B-1-10 USB_DrvEP_Close()

Close a device endpoint, and un-initialize/clear endpoint configuration in hardware.

FILES

Every device driver's `usbd_drv.c`

PROTOTYPE

```
static void USB_DrvEP_Close (USB_DRV      *p_drv,  
                             CPU_INT08U  ep_addr);
```

ARGUMENTS

`p_drv` Pointer to USB device driver structure.

`ep_addr` Endpoint address.

RETURNED VALUE

None.

CALLERS

- `USB_EP_Close()` via '`p_drv_api->EP_Close()`'
- `USB_CtrlOpen()`

NOTES / WARNINGS

Typically, the endpoint close function clears the endpoint information in the device controller. For some controllers, this may not be necessary.

B-1-11 USB_DrvEP_RxStart()

Configure endpoint with buffer to receive data.

FILES

Every device driver's `usbd_drv.c`

PROTOTYPE

```
static void USB_DrvEP_RxStart (USB_DRV   *p_drv,  
                               CPU_INT08U ep_addr,  
                               CPU_INT08U *p_buf,  
                               CPU_INT32U  buf_len,  
                               USB_ERR    *p_err);
```

ARGUMENTS

- `p_drv` Pointer to USB device driver structure.
- `ep_addr` Endpoint address.
- `p_buf` Pointer to data buffer.
- `buf_len` Length of the buffer.
- `p_err` Pointer to variable that will receive the return error code from this function.

RETURNED VALUE

None.

CALLERS

- `USB_EP_Rx()` via '`p_drv_api->EP_Rx()`'
- `USB_EP_Process()`

NOTES / WARNINGS

Typically, the function to configure the endpoint receive transaction performs the following operations:

- Determine maximum transaction length, given the specified length of the buffer (`buf_len`).
- Setup receive transaction.

B-1-12 USB_DrvEP_Rx()

Receive the specified amount of data from device endpoint.

FILES

Every device driver's `usbd_drv.c`

PROTOTYPE

```
static CPU_INT32U USB_DrvEP_Rx (USB_DRV    *p_drv,
                                CPU_INT08U  ep_addr,
                                CPU_INT08U  *p_buf,
                                CPU_INT32U  buf_len,
                                USBD_ERR    *p_err);
```

ARGUMENTS

- `p_drv` Pointer to USB device driver structure.
- `ep_addr` Endpoint address.
- `p_buf` Pointer to data buffer.
- `buf_len` Length of the buffer.
- `p_err` Pointer to variable that will receive the return error code from this function.

RETURNED VALUE

Number of octets received, if NO error(s)

0, otherwise

CALLERS

- `USB_EP_Rx()` via '`p_drv_api->EP_Rx()`'
- `USB_EP_Process()`

NOTES / WARNINGS

Typically, the receive from endpoint function performs the following operations:

- Check if packet has been received and is ready to be read.
- Determine packet length.
- If packet length is greater than `buf_len`, then copy the first `buf_len` octets into `p_buf`. Otherwise, copy the entire packet into `p_buf`.
- Clear endpoint buffer to allow next packet to be received. For some controllers, this may not be necessary.

B-1-13 USBD_DrvEP_RxZLP()

Receive zero-length packet from endpoint.

FILES

Every device driver's `usbd_drv.c`

PROTOTYPE

```
static void USBD_DrvEP_RxZLP (USB_DRV      *p_drv,  
                             CPU_INT08U   ep_addr,  
                             USB_D_ERR     *p_err);
```

ARGUMENTS

`p_drv` Pointer to USB device driver structure.

`ep_addr` Endpoint address.

`p_err` Pointer to variable that will receive the return error code from this function.

RETURNED VALUE

None.

CALLERS

`USB_EP_RxZLP()` via '`p_drv_api->EP_RxZLP()`'

NOTES / WARNINGS

None.

B-1-14 USB_DrvEP_Tx()

Configure endpoint with buffer to transmit data.

FILES

Every device driver's `usbd_drv.c`

PROTOTYPE

```
static CPU_INT32U USB_DrvEP_Tx (USB_DRV      *p_drv,
                                CPU_INT08U   ep_addr,
                                CPU_INT08U   *p_buf,
                                CPU_INT32U   buf_len,
                                USBD_ERR     *p_err);
```

ARGUMENTS

- `p_drv` Pointer to USB device driver structure.
- `ep_addr` Endpoint address.
- `p_buf` Pointer to data buffer.
- `buf_len` Length of the buffer.
- `p_err` Pointer to variable that will receive the return error code from this function.

RETURNED VALUE

Number of octets transmitted, if NO error(s).

0, otherwise.

CALLERS

- `USB_EP_Tx()` via '`p_drv_api->EP_Tx()`'
- `USB_EP_Process()`

NOTES / WARNINGS

Typically, the function to configure the endpoint receive transaction performs the following operations:

- Check if data can be transmitted.
- Write data to device endpoint.
- Configure the packet length in USB device controller. This is often necessary when the packet is shorter than the maximum packet size. Depending on the USB controller, this operation may need to be performed prior to writing the data to the device endpoint.

B-1-15 USB_DrvEP_TxStart()

Transmit the specified amount of data to device endpoint.

FILES

Every device driver's `usbd_drv.c`

PROTOTYPE

```
static void USB_DrvEP_TxStart (USB_DRV    *p_drv,  
                               CPU_INT08U  ep_addr,  
                               CPU_INT08U  *p_buf,  
                               CPU_INT32U   buf_len,  
                               USB_ERR     *p_err);
```

ARGUMENTS

`p_drv` Pointer to USB device driver structure.

`ep_addr` Endpoint address.

`p_buf` Pointer to data buffer.

`buf_len` Length of the buffer.

`p_err` Pointer to variable that will receive the return error code from this function.

RETURNED VALUE

Number of octets transmitted, if NO error(s).

0, otherwise.

CALLERS

- USBD_EP_Tx() via 'p_drv_api->EP_TxStart()'
- USBD_EP_Process()

NOTES / WARNINGS

Typically, the function to configure the endpoint receive transaction performs the following operations:

- Trigger packet transmission.

B-1-16 USB_DrvEP_TxZLP()

Transmit zero-length packet to endpoint.

FILES

Every device driver's `usbd_drv.c`

PROTOTYPE

```
static void USB_DrvEP_TxZLP (USB_DRV      *p_drv,  
                             CPU_INT08U   ep_addr,  
                             USB_ERR      *p_err);
```

ARGUMENTS

`p_drv` Pointer to USB device driver structure.

`ep_addr` Endpoint address.

`p_err` Pointer to variable that will receive the return error code from this function.

RETURNED VALUE

None.

CALLERS

- `USB_EP_Tx()` via '`p_drv_api->EP_TxZLP()`'
- `USB_EP_TxZLP()`
- `USB_EP_Process()`

NOTES / WARNINGS

None.

B-1-17 USBD_DrvEP_Abort()

Abort any pending transfer on endpoint.

FILES

Every device driver's `usbd_drv.c`

PROTOTYPE

```
static CPU_BOOLEAN USBD_DrvEP_Abort (USB_DRV    *p_drv,  
                                     CPU_INT08U  ep_addr);
```

ARGUMENTS

`p_drv` Pointer to USB device driver structure.

`ep_addr` Endpoint Address.

RETURNED VALUE

`DEF_OK`, if NO error(s).

`DEF_FAIL`, otherwise.

CALLERS

`USB_DrvEP_Abort()` via '`p_drv_api->EP_Abort()`'

NOTES / WARNINGS

None.

B-1-18 USB_DrvEP_Stall()

Set or clear stall condition on endpoint.

FILES

Every device driver's `usbd_drv.c`

PROTOTYPE

```
static CPU_BOOLEAN USB_DrvEP_Stall (USB_DRV      *p_drv,  
                                     CPU_INT08U   ep_addr,  
                                     CPU_BOOLEAN   state);
```

ARGUMENTS

`p_drv` Pointer to USB device driver structure.

`ep_addr` Endpoint address.

`state` Endpoint stall state.

RETURNED VALUE

`DEF_OK`, if NO error(s).

`DEF_FAIL`, otherwise.

CALLERS

- `USB_EP_Stall()` via '`p_drv_api->EP_Stall()`'
- `USB_CtrlStall()`

NOTES / WARNINGS

None.

B-1-19 USB_DrvISR_Handler()

USB device Interrupt Service Routine (ISR) handler.

FILES

Every device driver's `usbdrv.c`

PROTOTYPE

```
static void USB_DrvISR_Handler (USB_DRV *p_drv);
```

ARGUMENTS

`p_drv` Pointer to USB device driver structure.

RETURNED VALUE

None.

CALLERS

Processor level kernel-aware interrupt handler.

NOTES / WARNINGS

None.

B-2 DEVICE DRIVER BSP FUNCTIONS

B-2-1 USBD_BSP_Init()

Initialize board-specific USB controller dependencies.

FILES

Every device driver's `usbd_bsp.c`

PROTOTYPE

```
static void USBD_BSP_Init (USBDRV *p_drv);
```

ARGUMENTS

`p_drv` Pointer to USB device driver structure.

RETURNED VALUE

None.

CALLERS

`USBDRV_Init()`

NOTES / WARNINGS

None.

B-2-2 USBD_BSP_Conn()

Enable USB controller connection dependencies.

FILES

Every device driver's `usbd_bsp.c`

PROTOTYPE

```
static void USBD_BSP_Conn (void);
```

ARGUMENTS

None.

RETURNED VALUE

None.

CALLERS

`USB_DrvStart()`

NOTES / WARNINGS

None.

B-2-3 USBD_BSP_Disconn()

Disable USB controller connection dependencies.

FILES

Every device driver's `usbd_bsp.c`

PROTOTYPE

```
static void USBD_BSP_Disconn (void);
```

ARGUMENTS

None.

RETURNED VALUE

None.

CALLERS

`USB_DrvStop()`

NOTES / WARNINGS

None.

C

CDC API Reference

This appendix provides a reference to the μ C/USB-Device Communications Device Class (CDC) API and Abstract Control Model (ACM) subclass API. The following information is provided for each of the services:

- A brief description
- The function prototype
- The filename of the source code
- A description of the arguments passed to the function
- A description of returned value(s)
- Specific notes and warnings regarding use of the service

C-1 CDC FUNCTIONS

C-1-1 USBD_CDC_Init()

This function initializes all the internal variables and modules used by the CDC. The initialization function is called by the application exactly once.

FILES

usbd_cdc.h/usbd_cdc.c

PROTOTYPE

```
static void USBD_CDC_Init (USB_ERR *p_err);
```

ARGUMENTS

p_err Pointer to variable that will receive the return error code from this function:
 USB_ERR_NONE

RETURNED VALUE

None.

CALLERS

Application.

NOTES / WARNINGS

None.

C-1-2 USBD_CDC_Add()

This function creates a CDC instance.

FILES

usbd_cdc.h/usbd_cdc.c

PROTOTYPE

```
CPU_INT08U  USBD_CDC_Add(CPU_INT08U      subclass,
                        USBD_CDC_SUBCLASS_DRV *p_subclass_drv,
                        void                  *p_subclass_arg,
                        CPU_INT08U          protocol,
                        CPU_BOOLEAN          notify_en,
                        CPU_INT16U          notify_interval,
                        USBD_ERR             *p_err);
```

ARGUMENTS

subclass CDC subclass code.

USBDCDC_SUBCLASS_RSVD	Reserved value
USBDCDC_SUBCLASS_DLDM	Direct Line Control Model
USBDCDC_SUBCLASS_ACM	Abstract Control Model
USBDCDC_SUBCLASS_TCM	Telephone Control Model
USBDCDC_SUBCLASS_MCC	Multi-Channel Control Model
USBDCDC_SUBCLASS_CAPICM	CAPI Control Model
USBDCDC_SUBCLASS_WHCM	Wireless Handset Control Model
USBDCDC_SUBCLASS_DEV_MGMT	Device Management
USBDCDC_SUBCLASS_MDLM	Device Management
USBDCDC_SUBCLASS_OBEX	Obex
USBDCDC_SUBCLASS_EEM	Ethernet Emulation Model
USBDCDC_SUBCLASS_NCM	Network Control Model
USBDCDC_SUBCLASS_VENDOR	Vendor specific

CDC subclass codes are defined in the Universal Serial Bus Class Definitions for Communication Devices Revision 2.1 Table 4.

`p_subclass_drv` Pointer to CDC subclass driver.

`p_subclass_arg` Pointer to CDC subclass driver argument.

`protocol` CDC protocol code.

```

USBDCDC_COMM_PROTOCOL_NONE
USBDCDC_COMM_PROTOCOL_AT_V250
USBDCDC_COMM_PROTOCOL_AT_PCCA_101
USBDCDC_COMM_PROTOCOL_AT_PCCA_101_ANNEX
USBDCDC_COMM_PROTOCOL_AT_GSM_7_07
USBDCDC_COMM_PROTOCOL_AT_3GPP_27_07
USBDCDC_COMM_PROTOCOL_AT_TIA_CDMA
USBDCDC_COMM_PROTOCOL_EEM
USBDCDC_COMM_PROTOCOL_EXT
USBDCDC_COMM_PROTOCOL_VENDOR

```

CDC protocol codes are defined in the Universal Serial Bus Class Definitions for Communication Devices Revision 2.1 Table 5.

`notify_en` Notification enabled.

```

DEF_ENABLED           CDC notifications are enabled.
DEF_DISABLED          CDC notifications are disabled.

```

`notify_interval` Notification interval in milliseconds.

`p_err` Pointer to variable that will receive the return error code from this function.

```

USBDCDC_ERR_NONE
USBDCDC_ERR_ALLOC

```

RETURNED VALUE

CDC class interface number, if CDC class successfully created.

`USBDCDC_NBR_NONE`, otherwise.

CALLERS

CDC Subclass drivers.

NOTES / WARNINGS

The CDC defines a communication class interface consisting of a management element and optionally a notification element. The notification element transports event to the host. The `enable_en` enable notifications in the CDC. The notification are sent to the host using an interrupt endpoint, the interval of the interrupt endpoint is specified by the `notify_interval` parameter.

C-1-3 USBD_CDC_CfgAdd()

Add a CDC instance to specific USB configuration.

FILES

usbd_cdc.h/usbd_cdc.c

PROTOTYPE

```
CPU_BOOLEAN USBD_CDC_CfgAdd (CPU_INT08U class_nbr,
                             CPU_INT08U dev_nbr,
                             CPU_INT08U cfg_nbr,
                             USBD_ERR *p_err);
```

ARGUMENTS

class_nbr CDC instance number.

dev_nbr Device number.

cfg_nbr Configuration number.

p_err Pointer to variable that will receive the return error code from this function.

```
USB_D_ERR_NONE
USB_D_ERR_ALLOC
USB_D_ERR_INVALID_ARG
USB_D_ERR_DEV_INVALID_NBR
USB_D_ERR_DEV_INVALID_STATE
USB_D_ERR_CFG_INVALID_NBR
USB_D_ERR_IF_ALLOC
USB_D_ERR_IF_ALT_ALLOC
USB_D_ERR_IF_INVALID_NBR
USB_D_ERR_IF_GRP_NBR_IN_USE
USB_D_ERR_IF_GRP_ALLOC
USB_D_ERR_EP_NONE_AVAIL
USB_D_ERR_EP_ALLOC
```

RETURNED VALUE

DEF_OK, if CDC class instance was added to device configuration successfully.

DEF_FAIL, otherwise.

CALLERS

CDC Subclass drivers.

NOTES / WARNINGS

None.

C-1-4 USBD_CDC_IsConn()

Determine if CDC instance is connected.

FILES

usbd_cdc.h/usbd_cdc.c

PROTOTYPE

```
CPU_BOOLEAN USBD_CDC_IsConn (CPU_INT08U class_nbr)
```

ARGUMENTS

`class_nbr` CDC instance number.

RETURNED VALUE

`DEF_OK`, if CDC instance is connected and device is not in suspended state.

`DEF_FAIL`, otherwise.

CALLERS

- CDC Subclass drivers
- Application

NOTES / WARNINGS

If the `USB_D_CDC_IsConn()` returns `DEF_OK`, then the CDC instance is ready for management, notification, read and write operations.

C-1-5 USBD_CDC_DataIF_Add()

Add a data interface class to CDC.

FILES

usbd_cdc.h/usbd_cdc.c

PROTOTYPE

```
CPU_INT08U  USBD_CDC_DataIF_Add (CPU_INT08U  class_nbr,
                                CPU_BOOLEAN  isoc_en,
                                CPU_INT08U  protocol,
                                USBD_ERR    *p_err);
```

ARGUMENTS

class_nbr CDC instance number.

isoc_en Data interface isochronous enable.

DEF_ENABLED Data interface uses isochronous endpoints.

DEF_DISABLED Data interface uses bulk endpoints.

protocol Data interface protocol code:

USBDCDC_DATA_PROTOCOL_NONE No class specific protocol required.

USBDCDC_DATA_PROTOCOL_NTB Network Transfer Block.

USBDCDC_DATA_PROTOCOL_PHY Physical interface protocol for ISDN BRI.

USBDCDC_DATA_PROTOCOL_HDLC HDLC.

USBDCDC_DATA_PROTOCOL_TRANS Transparent.

USBDCDC_DATA_PROTOCOL_Q921M Management protocol for Q.921 data link protocol.

USBDCDC_DATA_PROTOCOL_Q921 Data link protocol for Q.921.

USBDCDC_DATA_PROTOCOL_Q921TM TEI-multiplexor for Q.921 data link protocol

USBDCDC_DATA_PROTOCOL_COMPRESS Data compression procedures.

USBDCDC_DATA_PROTOCOL_Q9131 Euro-ISDN protocol control.

<code>USBD_CDC_DATA_PROTOCOL_V24</code>	V.24 rate adaptation to ISDN.
<code>USBD_CDC_DATA_PROTOCOL_CAPI</code>	CAPI Commands.
<code>USBD_CDC_DATA_PROTOCOL_HOST</code>	Host based driver.
<code>USBD_CDC_DATA_PROTOCOL_CDC</code>	The protocol(s) are described using a Protocol Unit Function Communication Class Interface.
<code>USBD_CDC_DATA_PROTOCOL_VENDOR</code>	Vendor-specific.

CDC data interface class protocol codes are defined in the Universal Serial Bus Class Definitions for Communication Devices Revision 2.1 Table 7.

`p_err` Pointer to variable that will receive the return error code from this function.

- `USBD_ERR_NONE`
- `USBD_ERR_ALLOC`
- `USBD_ERR_INVALID_ARG`

RETURNED VALUE

Data interface number, if no errors.

`USBD_CDC_DATA_IF_NBR_NONE`, otherwise .

CALLERS

CDC Subclass drivers.

NOTES / WARNINGS

None.

C-1-6 USBD_CDC_DataRx()

Receive data on CDC data interface.

FILES

usbd_cdc.h/usbd_cdc.c

PROTOTYPE

```
CPU_INT32U  USBD_CDC_DataRx (CPU_INT08U  class_nbr,
                             CPU_INT08U  data_if_nbr,
                             CPU_INT08U  *p_buf,
                             CPU_INT32U  buf_len,
                             CPU_INT16U  timeout,
                             USBD_ERR    *p_err);
```

ARGUMENTS

class_nbr CDC instance number.

data_if_nbr CDC data interface number.

p_buf Pointer to destination buffer to receive data.

buf_len Number of octets to receive.

timeout_ms Timeout in milliseconds.

p_err Pointer to variable that will receive the return error code from this function.

```
USB_D_ERR_NONE
USB_D_ERR_INVALID_ARG
USB_D_ERR_INVALID_CLASS_STATE
USB_D_ERR_DEV_INVALID_NBR
USB_D_ERR_DEV_INVALID_STATE
USB_D_ERR_EP_INVALID_ADDR
USB_D_ERR_EP_INVALID_STATE
USB_D_ERR_EP_INVALID_TYPE
```

USBD_ERR_OS_TIMEOUT
USBD_ERR_OS_ABORT
USBD_ERR_OS_FAIL

RETURNED VALUE

Numbers of octets received, if no errors.
0, otherwise .

CALLERS

CDC Subclass drivers.

NOTES / WARNINGS

None.

C-1-7 USBD_CDC_DataTx()

Send data on CDC data class interface.

FILES

usbd_cdc.h/usbd_cdc.c

PROTOTYPE

```
CPU_INT32U  USBD_CDC_DataTx (CPU_INT08U  class_nbr,
                             CPU_INT08U  data_if_nbr,
                             CPU_INT08U  *p_buf,
                             CPU_INT32U  buf_len,
                             CPU_INT16U  timeout,
                             USBD_ERR    *p_err);
```

ARGUMENTS

class_nbr CDC instance number.

data_if_nbr CDC data interface number.

p_buf Pointer to buffer of data that will be transmitted.

buf_len Number of octets to transmit.

timeout_ms Timeout in milliseconds.

p_err Pointer to variable that will receive the return error code from this function.

```
USB_D_ERR_NONE
USB_D_ERR_INVALID_ARG
USB_D_ERR_INVALID_CLASS_STATE
USB_D_ERR_DEV_INVALID_NBR
USB_D_ERR_DEV_INVALID_STATE
USB_D_ERR_EP_INVALID_ADDR
USB_D_ERR_EP_INVALID_STATE
USB_D_ERR_EP_INVALID_TYPE
```

USBD_ERR_OS_TIMEOUT
USBD_ERR_OS_ABORT
USBD_ERR_OS_FAIL

RETURNED VALUE

Numbers of octets transmitted, if no errors.
0, otherwise.

CALLERS

CDC Subclass drivers.

NOTES / WARNINGS

None.

C-1-8 USBD_CDC_Notify()

Send communication interface class notification to the host.

FILES

usbd_cdc.h/usbd_cdc.c

PROTOTYPE

```
CPU_BOOLEAN  USBD_CDC_Notify (CPU_INT08U  class_nbr,
                             CPU_INT08U  notification,
                             CPU_INT16U  value,
                             CPU_INT08U  *p_buf,
                             CPU_INT16U  data_len,
                             USBD_ERR    *p_err);
```

ARGUMENTS

class_nbr CDC instance number.

notification Notification code (see Note #1).

value Notification value (see Note #1).

p_buf Pointer to notification buffer (see Note #2).

data_len Notification's data section length.

p_err Pointer to variable that will receive the return error code from this function.

```
USBD_ERR_NONE
USBD_ERR_INVALID_ARG
USBD_ERR_INVALID_CLASS_STATE
USBD_ERR_DEV_INVALID_NBR
USBD_ERR_DEV_INVALID_STATE
USBD_ERR_EP_INVALID_ADDR
USBD_ERR_EP_INVALID_STATE
USBD_ERR_EP_INVALID_TYPE
```

```

USB_D_ERR_OS_TIMEOUT
USB_D_ERR_OS_ABORT
USB_D_ERR_OS_FAIL

```

RETURNED VALUE

None.

CALLERS

CDC Subclass drivers.

NOTES / WARNINGS

- 1 The following table show the relationship between CDC request and the parameters passed in the `USB_D_CDC_Notify()` function. The *bmRequestType* and *wIndex* fields are calculated internally in the CDC module.

bmRequestType	bNotificationCode	wValue	wIndex	wLength	Data
1010001b	notification	value	Interface	data_len	p_buf[7] to p_buf[data_len -1]

- 2 The notification buffer size *must* contain space for the notification header (8 bytes and the variable-length data portion).

C-2 CDC ACM SUBCLASS FUNCTIONS

C-2-1 USBD_ACM_SerialInit()

Initialize CDC ACM serial emulation subclass.

FILES

usbdc_acm_serial.h/usbdc_acm_serial.c

PROTOTYPE

```
void USBD_ACM_SerialInit (USBDC_ERR *p_err);
```

ARGUMENTS

p_err Pointer to variable that will receive the return error code from this function:
 USBDC_ERR_NONE.

RETURNED VALUE

None.

CALLERS

Application.

NOTES / WARNINGS

None.

C-2-2 USBD_ACM_SerialAdd()

Add a new CDC ACM serial emulation instance.

FILES

usb_d_acm_serial.h/usb_d_acm_serial.c

PROTOTYPE

```
CPU_INT08U USBD_ACM_SerialAdd (CPU_INT16U line_state_interval,
                               USBD_ERR *p_err);
```

ARGUMENTS

line_state_interval Polling interval in frames or microframes for line state notification.

p_err Pointer to variable that will receive the return error code from this function.

```
USB_ERR_NONE
USB_ERR_ALLOC
USB_ERR_INVALID_ARG
```

RETURNED VALUE

CDC ACM serial emulation subclass instance number, if no errors.

USB_D_ACM_SERIAL_NBR_NONE, otherwise.

CALLERS

Application.

NOTES / WARNINGS

None.

C-2-3 USBD_ACM_SerialCfgAdd()

Add CDC ACM subclass instance to USB device configuration.

FILES

usbd_acm_serial.h/usbd_acm_serial.c

PROTOTYPE

```
CPU_BOOLEAN USBD_ACM_SerialCfgAdd (CPU_INT08U subclass_nbr,  
                                     CPU_INT08U dev_nbr,  
                                     CPU_INT08U cfg_nbr,  
                                     USBD_ERR *p_err);
```

ARGUMENTS

subclass_nbr CDC ACM serial emulation subclass instance number.

dev_nbr Device number.

cfg_nbr Configuration number.

p_err Pointer to variable that will receive the return error code from this function.

```
USB_ERR_NONE  
USB_ERR_INVALID_ARG  
USB_ERR_ALLOC  
USB_ERR_INVALID_CLASS_STATE  
USB_ERR_DEV_INVALID_NBR  
USB_ERR_CFG_INVALID_NBR  
USB_ERR_IF_ALLOC  
USB_ERR_IF_ALT_ALLOC  
USB_ERR_EP_NONE_AVAIL  
USB_ERR_EP_ALLOC
```

RETURNED VALUE

DEF_OK, If CDC ACM serial emulation subclass instance was added to device configuration successfully.

DEF_FAIL, Otherwise.

CALLERS

Application.

NOTES / WARNINGS

None.

C-2-4 USBD_ACM_SerialIsConn()

Determine if CDC ACM serial emulation class instance is connected.

FILES

usbd_acm_serial.h/usbd_acm_serial.c

PROTOTYPE

```
CPU_BOOLEAN USBD_ACM_SerialIsConn (CPU_INT08U subclass_nbr);
```

ARGUMENTS

subclass_nbr CDC ACM serial emulation subclass instance number.

RETURNED VALUE

DEF_OK, If CDC ACM serial emulation subclass instance is connected and device is not in suspended state.

DEF_FAIL, otherwise .

CALLERS

Application.

NOTES / WARNINGS

None.

C-2-5 USBD_ACM_SerialRx()

Receive data on CDC ACM serial emulation subclass.

FILES

usb_d_acm_serial.h/usb_d_acm_serial.c

PROTOTYPE

```
CPU_INT32U  USBD_ACM_SerialRx (CPU_INT08U  subclass_nbr,
                               CPU_INT08U  *p_buf,
                               CPU_INT32U  buf_len,
                               CPU_INT16U  timeout,
                               USBD_ERR    *p_err);
```

ARGUMENTS

subclass_nbr Pointer to USB device driver structure.

p_buf Pointer to destination buffer to receive data.

buf_len Number of octets to receive.

timeout_ms Timeout in milliseconds.

p_err Pointer to variable that will receive the return error code from this function.

```
USB_D_ERR_NONE
USB_D_ERR_INVALID_ARG
USB_D_ERR_INVALID_CLASS_STATE
USB_D_ERR_EP_INVALID_ADDR
USB_D_ERR_EP_INVALID_STATE
USB_D_ERR_EP_INVALID_TYPE
USB_D_ERR_OS_TIMEOUT
USB_D_ERR_OS_ABORT
USB_D_ERR_OS_FAIL
```

RETURNED VALUE

None.

CALLERS

Numbers of octets received, if NO error(s).

0, otherwise.

NOTES / WARNINGS

None.

C-2-6 USBD_ACM_SerialTx()

Send data on CDC ACM serial emulation subclass.

FILES

usbdc_acm_serial.h/usbdc_acm_serial.c

PROTOTYPE

```
CPU_INT32U USBD_ACM_SerialTx (CPU_INT08U subclass_nbr,
                               CPU_INT08U *p_buf,
                               CPU_INT32U buf_len,
                               CPU_INT16U timeout,
                               USBD_ERR *p_err);
```

ARGUMENTS

subclass_nbr Pointer to USB device driver structure.

p_buf Pointer to buffer of data that will be transmitted.

buf_len Number of octets to receive.

timeout_ms Timeout in milliseconds.

p_err Pointer to variable that will receive the return error code from this function.

```
USBDC_ERR_NONE
USBDC_ERR_INVALID_ARG
USBDC_ERR_INVALID_CLASS_STATE
USBDC_ERR_EP_INVALID_ADDR
USBDC_ERR_EP_INVALID_STATE
USBDC_ERR_EP_INVALID_TYPE
USBDC_ERR_OS_TIMEOUT
USBDC_ERR_OS_ABORT
USBDC_ERR_OS_FAIL
```

RETURNED VALUE

Number of octets transmitted, if NO error(s).
0, otherwise.

CALLERS

Application.

NOTES / WARNINGS

None.

C-2-7 USBD_ACM_SerialLineCtrlGet()

Return current control line state.

FILES

usbdc_acm_serial.h/usbdc_acm_serial.c

PROTOTYPE

```
CPU_INT08U USBDC_ACM_SerialLineCtrlGet (CPU_INT08U subclass_nbr,
                                         USBDC_ERR *p_err);
```

ARGUMENTS

subclass_nbr CDC ACM serial emulation subclass instance number.

p_err Pointer to variable that will receive the return error code from this function.

USBDC_ERR_NONE

USBDC_ERR_INVALID_ARG

RETURNED VALUE

Bit-field with the state of the control line.

USBDC_ACM_SERIAL_CTRL_BREAK Break signal is set.

USBDC_ACM_SERIAL_CTRL_RTS RTS signal is set.

USBDC_ACM_SERIAL_CTRL_DTR DTR signal is set.

CALLERS

Application.

NOTES / WARNINGS

None.

C-2-8 USBD_ACM_SerialLineCtrlReg()

Register line control change notification callback.

FILES

usbd_acm_serial.h/usbd_acm_serial.c

PROTOTYPE

```
void USBD_ACM_SerialLineCtrlReg (CPU_INT08U          subclass_nbr,  
                                USBD_ACM_SERIAL_LINE_CTRL_CHNGD line_ctrl_chngd,  
                                void                  *p_arg,  
                                USBD_ERR              *p_err);
```

ARGUMENTS

subclass_nbr CDC ACM serial emulation subclass instance number.

line_ctrl_chngd Line control change notification callback (see note #1).

p_arg Pointer to callback argument.

p_err Pointer to variable that will receive the return error code from this function.

```
USB_ERR_NONE  
USB_ERR_INVALID_ARG
```

RETURNED VALUE

None.

CALLERS

Application.

NOTES / WARNINGS

The callback specified by `line_ctrl_chngd` argument is used to notify changes in the control signals to the application.

The line control notification function has the following prototype:

```
void AppLineCtrlChngd (CPU_INT08U subclass_nbr,  
                      CPU_INT08U events,  
                      CPU_INT08U events_chngd,  
                      void *p_arg);
```

Argument(s):

<code>subclass_nbr</code>	CDC ACM serial emulation subclass instance number.
<code>events</code>	Current line state.
<code>events_chngd</code>	Line state flags that have changed.
<code>events_chngd</code>	Pointer to callback argument.

C-2-9 USBD_ACM_SerialLineCodingGet()

Get the current state of the line coding.

FILES

usb_d_acm_serial.h/usb_d_acm_serial.c

PROTOTYPE

```
void USBD_ACM_SerialLineCodingGet (CPU_INT08U          subclass_nbr,  
                                   USBD_ACM_SERIAL_LINE_CODING *p_line_coding,  
                                   USBD_ERR              *p_err);
```

ARGUMENTS

subclass_nbr CDC ACM serial emulation subclass instance number.

p_line_coding Pointer to the structure where the current line coding will be stored.

p_err Pointer to variable that will receive the return error code from this function.

```
USB_D_ERR_NONE  
USB_D_ERR_INVALID_ARG  
USB_D_ERR_NULL_PTR
```

RETURNED VALUE

None.

CALLERS

Application.

NOTES / WARNINGS

None.

C-2-10 USBD_ACM_SerialLineCodingSet()

Set a new line coding.

FILES

usbd_acm_serial.h/usbd_acm_serial.c

PROTOTYPE

```
void USBD_ACM_SerialLineCodingSet (CPU_INT08U          subclass_nbr,
                                   USBD_ACM_SERIAL_LINE_CODING *p_line_coding,
                                   USBD_ERR              *p_err);
```

ARGUMENTS

subclass_nbr CDC ACM serial emulation subclass instance number.

p_line_coding Pointer to the structure where that contains the new line coding.

p_err Pointer to variable that will receive the return error code from this function.

```
USB_ERR_NONE
USB_ERR_INVALID_ARG
USB_ERR_NULL_PTR
```

RETURNED VALUE

None.

CALLERS

Application.

NOTES / WARNINGS

None.

C-2-11 USBD_ACM_SerialLineCodingReg()

Register line coding change notification callback.

FILES

usbd_acm_serial.h/usbd_acm_serial.c

PROTOTYPE

```
void USBD_ACM_SerialLineCodingReg(CPU_INT08U          subclass_nbr,  
                                   USBD_ACM_SERIAL_LINE_CODING_CHNGD line_coding_chngd,  
                                   void                *p_arg,  
                                   USBD_ERR            *p_err);
```

ARGUMENTS

subclass_nbr CDC ACM serial emulation subclass instance number.

line_coding_chngd Line coding change notification callback (see Note #1).

p_arg Pointer to callback argument.

p_err Pointer to variable that will receive the return error code from this function.

```
USB_ERR_NONE  
USB_ERR_INVALID_ARG
```

RETURNED VALUE

None.

CALLERS

Application.

NOTES / WARNINGS

- The callback specified by `line_coding_chngd` argument is used to notify changes in the control signals to the application.

The line control notification function has the following prototype:

```
CPU_BOOLEAN AppLineCodingChngd (CPU_INT08U subclass_nbr,
                                ...      *p_line_coding,
                                void      *p_arg);
```

Arguments:

`subclass_nbr` CDC ACM serial emulation subclass instance number.

`p_line_coding` Pointer to line coding structure.

`p_arg` Pointer to callback argument.

Returned value:

`DEF_OK,` If line coding is supported by the application.

`DEF_FAIL,` Otherwise.

C-2-12 USBD_ACM_SerialLineStateSet()

Set one or several line state events.

FILES

usbd_acm_serial.h/usbd_acm_serial.c

PROTOTYPE

```
CPU_BOOLEAN USBD_ACM_SerialLineStateSet (CPU_INT08U subclass_nbr,
                                           CPU_INT08U events);
```

ARGUMENTS

subclass_nbr CDC ACM serial emulation subclass instance number.

events Line state event(s) to set.

USBD_ACM_SERIAL_STATE_DCD	DCD (Rx carrier)
USBD_ACM_SERIAL_STATE_DSR	DSR (Tx carrier)
USBD_ACM_SERIAL_STATE_BREAK	Break
USBD_ACM_SERIAL_STATE_RING	Ring
USBD_ACM_SERIAL_STATE_FRAMING	Framing error
USBD_ACM_SERIAL_STATE_PARITY	Parity error
USBD_ACM_SERIAL_STATE_OVERUN	Overrun

RETURNED VALUE

DEF_OK, if new line state event set successfully.

DEF_FAIL, otherwise.

CALLERS

Application.

NOTES / WARNINGS

None.

C-2-13 USBD_ACM_SerialLineStateClr()

Clear one or several line state event(s).

FILES

usbd_acm_serial.h/usbd_acm_serial.c

PROTOTYPE

```
CPU_BOOLEAN USBD_ACM_SerialLineStateSet (CPU_INT08U subclass_nbr,
                                           CPU_INT08U events);
```

ARGUMENTS

subclass_nbr CDC ACM serial emulation subclass instance number.

events Line state event(s) to clear (see Note #1).

USB_D_ACM_SERIAL_STATE_DCD DCD (Rx carrier)

USB_D_ACM_SERIAL_STATE_DSR DSR (Tx carrier)

RETURNED VALUE

DEF_OK, if new line state event clear successfully.

DEF_FAIL, otherwise.

CALLERS

Application.

NOTES / WARNINGS

- Universal Serial Bus Communications Class Subclass Specification for PSTN Devices version 1.2 states: “For the irregular signals like break, the incoming ring signal, or the overrun error state, this will reset their values to zero and again will not send another notification until their state changes”. The irregular events are self-clear and cannot be clear using this function.

D

HID API Reference

This appendix provides a reference to the Human Interface Device (HID) class API. The following information is provided for each of the services:

- A brief description
- The function prototype
- The filename of the source code
- A description of the arguments passed to the function
- A description of returned value(s)
- Specific notes and warnings regarding use of the service

D-1 HID CLASS FUNCTIONS

D-1-1 USBD_HID_Init()

This function initializes all the internal variables and modules used by the HID class.

FILES

usbd_hid.c

PROTOTYPE

```
void USBD_HID_Init (USB_ERR *p_err);
```

ARGUMENTS

p_err Pointer to variable that will receive the return error code from this function.

 USB_ERR_NONE

RETURNED VALUE

None.

CALLERS

Application.

NOTES / WARNINGS

The initialization function *must* be called only once by the application, and before calling any other HID API.

D-1-2 USBD_HID_Add()

This function adds a new instance of the HID class.

FILES

usbhid.c

PROTOTYPE

```
void USBD_HID_Add (CPU_INT08U          subclass,
                  CPU_INT08U          protocol,
                  USBD_HID_COUNTRY_CODE country_code,
                  CPU_INT08U          *p_report_desc,
                  CPU_INT16U          report_desc_len,
                  CPU_INT08U          *p_phy_desc,
                  CPU_INT16U          phy_desc_len,
                  CPU_INT16U          interval_in,
                  CPU_INT16U          interval_out,
                  CPU_BOOLEAN          ctrl_rd_en,
                  USBD_HID_CALLBACK    *p_hid_callback,
                  USBD_ERR             *p_err);
```

ARGUMENTS

<code>subclass</code>	Subclass code.
<code>protocol</code>	Protocol code.
<code>country_code</code>	Country code ID.
<code>p_report_desc</code>	Pointer to report descriptor structure.
<code>report_desc_len</code>	Report descriptor length.
<code>p_phy_desc</code>	Pointer to physical descriptor structure.
<code>phy_desc_len</code>	Physical descriptor length.
<code>interval_in</code>	Polling interval for input transfers, in milliseconds.

interval_out Polling interval for output transfers, in milliseconds. Used only when read operations are not through control transfers.

ctrl_rd_en Enable read operations through control transfers.

p_hid_callback Pointer to HID descriptor and request callback structure.

p_err Pointer to variable that will receive the return error code from this function.

USBD_ERR_NONE
 USBD_ERR_ALLOC
 USBD_ERR_NULL_PTR
 USBD_ERR_INVALID_ARG
 USBD_ERR_FAIL

RETURNED VALUE

Class interface number, if NO error(s).

USBD_CLASS_NBR_NONE, otherwise.

CALLERS

Application.

NOTES / WARNINGS

None.

D-1-3 USBD_HID_CfgAdd()

This function adds HID class instance into USB device configuration.

FILES

usbd_hid.c

PROTOTYPE

```
CPU_BOOLEAN USBD_HID_CfgAdd (CPU_INT08U  class_nbr,  
                             CPU_INT08U  dev_nbr,  
                             CPU_INT08U  cfg_nbr,  
                             USBD_ERR    *p_err);
```

ARGUMENTS

class_nbr Class instance number.

dev_nbr Device number.

cfg_nbr Configuration index to add class instance to.

p_err Pointer to variable that will receive the return error code from this function.

```
USB_ERR_NONE  
USB_ERR_ALLOC  
USB_ERR_INVALID_ARG  
USB_ERR_NULL_PTR  
USB_ERR_DEV_INVALID_NBR  
USB_ERR_DEV_INVALID_STATE  
USB_ERR_CFG_INVALID_NBR  
USB_ERR_IF_ALLOC  
USB_ERR_IF_ALT_ALLOC  
USB_ERR_EP_NONE_AVAIL  
USB_ERR_IF_INVALID_NBR  
USB_ERR_EP_ALLOC
```

RETURNED VALUE

DEF_YES, if NO error(s).

DEF_NO, otherwise.

CALLERS

Application.

NOTES / WARNINGS

This API may be called several times. This allows to create multiple instances of the HID class into different USB device configurations.

D-1-4 USBD_HID_IsConn()

This function returns the HID class connection state.

FILES

usbd_hid.c

PROTOTYPE

```
CPU_BOOLEAN USBD_HID_IsConn (CPU_INT08U class_nbr);
```

ARGUMENTS

`class_nbr` Class instance number.

RETURNED VALUE

`DEF_YES`, if class is connected.

`DEF_NO`, otherwise.

CALLERS

Application.

NOTES / WARNINGS

The class connected state also implies the USB device is in configured state.

D-1-5 USBD_HID_Rd()

This function receives data from the host through an interrupt OUT endpoint.

FILES

usbd_hid.c

PROTOTYPE

```
CPU_INT32U USBD_HID_Rd (CPU_INT08U  class_nbr,
                        void          *p_buf,
                        CPU_INT32U   buf_len,
                        CPU_INT16U   timeout,
                        USBD_ERR     *p_err);
```

ARGUMENTS

class_nbr Class instance number.

p_buf Pointer to receive buffer.

buf_len Receive buffer length, in octets.

timeout Timeout, in milliseconds.

p_err Pointer to variable that will receive the return error code from this function.

```
USB_D_ERR_NONE
USB_D_ERR_NULL_PTR
USB_D_ERR_INVALID_ARG
USB_D_ERR_INVALID_CLASS_STATE
USB_D_ERR_DEV_INVALID_NBR
USB_D_ERR_EP_INVALID_NBR
USB_D_ERR_DEV_INVALID_STATE
USB_D_ERR_EP_INVALID_TYPE
```

RETURNED VALUE

Number of octets received, if NO error(s).

0, otherwise.

CALLERS

Application.

NOTES / WARNINGS

None.

D-1-6 USBD_HID_RdAsync()

This function receives data from the host asynchronously through an interrupt OUT endpoint.

FILES

usbd_hid.c

PROTOTYPE

```
void USBD_HID_RdAsync (CPU_INT08U      class_nbr,
                      void             *p_buf,
                      CPU_INT32U      buf_len,
                      USBD_HID_ASYNC_FNCT async_funct,
                      void             *p_async_arg,
                      USBD_ERR        *p_err);
```

ARGUMENTS

class_nbr Class instance number.

p_buf Pointer to receive buffer.

buf_len Receive buffer length, in octets.

async_funct Receive callback.

p_async_arg Additional argument provided by application for receive callback.

p_err Pointer to variable that will receive the return error code from this function.

```
USB_ERR_NONE
USB_ERR_NULL_PTR
USB_ERR_INVALID_ARG
USB_ERR_INVALID_CLASS_STATE
USB_ERR_FAIL
USB_ERR_DEV_INVALID_NBR
USB_ERR_EP_INVALID_NBR
```

```
USBD_ERR_DEV_INVALID_STATE
USBD_ERR_EP_INVALID_TYPE
USBD_ERR_EP_INVALID_STATE
```

RETURNED VALUE

None.

CALLERS

Application.

NOTES / WARNINGS

This function is non-blocking and returns immediately after transfer preparation. Upon transfer completion, the callback provided is called to notify the application.

D-1-7 USBD_HID_Wr()

This function transmits data to the host through an interrupt IN endpoint.

FILES

usbd_hid.c

PROTOTYPE

```
CPU_INT32U USBD_HID_Wr (CPU_INT08U  class_nbr,  
                        void          *p_buf,  
                        CPU_INT32U    buf_len,  
                        CPU_INT16U    timeout,  
                        USBD_ERR      *p_err);
```

ARGUMENTS

class_nbr Class instance number.

p_buf Pointer to transmit buffer.

buf_len Transmit buffer length, in octets.

timeout Timeout, in milliseconds.

p_err Pointer to variable that will receive the return error code from this function.

```
USB_D_ERR_NONE  
USB_D_ERR_NULL_PTR  
USB_D_ERR_INVALID_ARG  
USB_D_ERR_INVALID_CLASS_STATE  
USB_D_ERR_DEV_INVALID_NBR  
USB_D_ERR_EP_INVALID_NBR  
USB_D_ERR_DEV_INVALID_STATE  
USB_D_ERR_EP_INVALID_TYPE
```

RETURNED VALUE

Number of octets transmitted, if NO error(s).

0, otherwise.

CALLERS

Application.

NOTES / WARNINGS

None.

D-1-8 USBD_HID_WrAsync()

This function transmits data to the host asynchronously through an interrupt IN endpoint.

FILES

usbd_hid.c

PROTOTYPE

```
void USBD_HID_WrAsync (CPU_INT08U      class_nbr,
                      void             *p_buf,
                      CPU_INT32U      buf_len,
                      USBD_HID_ASYNC_FNCT async_fnct,
                      void             *p_async_arg,
                      USBD_ERR        *p_err);
```

ARGUMENTS

class_nbr Class instance number.

p_buf Pointer to transmit buffer.

buf_len Transmit buffer length, in octets.

async_fnct Transmit callback.

p_async_arg Additional argument provided by application for transmit callback.

p_err Pointer to variable that will receive the return error code from this function.

```
USB_D_ERR_NONE
USB_D_ERR_NULL_PTR
USB_D_ERR_INVALID_ARG
USB_D_ERR_INVALID_CLASS_STATE
USB_D_ERR_FAIL
USB_D_ERR_DEV_INVALID_NBR
USB_D_ERR_EP_INVALID_NBR
USB_D_ERR_DEV_INVALID_STATE
USB_D_ERR_EP_INVALID_TYPE
USB_D_ERR_EP_INVALID_STATE
```

RETURNED VALUE

None.

CALLERS

Application.

NOTES / WARNINGS

This function is non-blocking and returns immediately after transfer preparation. Upon transfer completion, the callback provided is called to notify the application.

D-2 HID OS FUNCTIONS

D-2-1 USBD_HID_OS_Init()

Initialize HID OS interface.

FILES

usbd_hid_os.c

PROTOTYPE

```
void USBD_HID_OS_Init (USB_ERR *p_err);
```

ARGUMENTS

p_err Pointer to variable that will receive the return error code from this function.

USB_ERR_NONE

OS error code(s) relevant to failure(s).

CALLERS

USB_HID_Init()

IMPLEMENTATION GUIDELINES

The `USB_HID_Init()` function is called only once by the HID class. It usually performs the following operations:

- For each class instance up to the maximum number of HID class instances defined by the constant `USB_HID_CFG_MAX_NBR_DEV`, create all the required semaphores. If the any semaphore creation fails, set `p_err` to `USB_ERR_OS_SIGNAL_CREATE` and return.
- Create a task used to manage periodic Input reports. If the task creation fails, set `p_err` to `USB_ERR_OS_INIT_FAIL` and return.
- Set `p_err` to `USB_ERR_NONE` if the initialization proceeded as expected.

D-2-2 USBD_HID_OS_InputLock()

Lock class input report.

FILES

usbd_hid_os.c

PROTOTYPE

```
void USBD_HID_OS_InputLock (CPU_INT08U  class_nbr,
                           USBD_ERR    *p_err);
```

ARGUMENTS

class_nbr Class instance number.

p_err Pointer to variable that will receive the return error code from this function.

USB_D_ERR_NONE: OS error code(s) relevant to failure(s).

CALLERS

USB_D_HID_Wr ()

USB_D_HID_WrAsync ()

USB_D_HID_ClassReq ()

IMPLEMENTATION GUIDELINES

The lock operation typically consists in pending on a semaphore. If the semaphore is free, the task continues normally its execution, otherwise it waits until another task releases the semaphore. **p_err** argument should be assigned as described in Table D-1.

Operation result	Error code to assign
No error	USB_D_ERR_NONE
Pend aborted	USB_D_ERR_OS_ABORT
Pend failed for any other reason	USB_D_ERR_OS_FAIL

Table D-1 **p_err** assignment according to the pend operation result

D-2-3 USBD_HID_OS_InputUnlock()

Unlock class input report.

FILES

usbd_hid_os.c

PROTOTYPE

```
void USBD_HID_OS_InputUnlock (CPU_INT08U class_nbr);
```

ARGUMENTS

`class_nbr` Class instance number.

CALLERS

USB_HID_Wr()

USB_HID_WrAsync()

USB_HID_ClassReq()

IMPLEMENTATION GUIDELINES

The unlock operation simply consists in posting a semaphore.

D-2-4 USBD_HID_OS_InputDataPend()

Wait for input report data to complete.

FILES

usbd_hid_os.c

PROTOTYPE

```
void USBD_HID_OS_InputDataPend (CPU_INT08U  class_nbr
                                CPU_INT16U  timeout_ms,
                                USBD_ERR    *p_err);
```

ARGUMENTS

class_nbr Class instance number.

timeout_ms Signal wait timeout in milliseconds

p_err Pointer to variable that will receive the return error code from this function.

USB_ERR_NONE

 OS error code(s) relevant to failure(s)

CALLERS

USB_HID_Wr()

IMPLEMENTATION GUIDELINES

The wait operation typically consists in pending on a semaphore. When the input report transfer has completed, the task is waken up by the Core layer internal task responsible for asynchronous communication. **p_err** argument should be assigned as described in Table D-2.

Operation result	Error code to assign
No error	USBD_ERR_NONE
Pend timeout	USBD_ERR_OS_TIMEOUT
Pend aborted	USBD_ERR_OS_ABORT
Pend failed for any other reason	USBD_ERR_OS_FAIL

Table D-2 **p_err** assignment according to the pend operation result

D-2-5 USBD_HID_OS_InputDataPendAbort()

Abort any operation on input report.

FILES

usbd_hid_os.c

PROTOTYPE

```
void USBD_HID_OS_InputDataPendAbort (CPU_INT08U class_nbr);
```

ARGUMENTS

`class_nbr` Class instance number.

CALLERS

USB_D_HID_WrSyncCmpl()

IMPLEMENTATION GUIDELINES

If the input report transfer completes with an error, the task waiting is waken up by aborting the active wait done with `USB_D_HID_OS_InputDataPend()`. The active wait abortion is executed by the Core layer internal task responsible for asynchronous communication.

D-2-6 USBD_HID_OS_InputDataPost()

Signal that Input report data has been sent to the host.

FILES

usbd_hid_os.c

PROTOTYPE

```
void USBD_HID_OS_InputDataPost (CPU_INT08U class_nbr);
```

ARGUMENTS

`class_nbr` Class instance number.

CALLERS

USB_D_HID_WrSyncCmpl()

IMPLEMENTATION GUIDELINES

If the input report transfer completes without an error, the task waiting is waken up by posting a semaphore. The semaphore post is executed by the Core layer internal task responsible for asynchronous communication.

D-2-7 USBD_HID_OS_OutputLock()

Lock class output report.

FILES

usbd_hid_os.c

PROTOTYPE

```
void USBD_HID_OS_OutputLock (CPU_INT08U class_nbr,
                             USBD_ERR *p_err);
```

ARGUMENTS

class_nbr Class instance number.

p_err Pointer to variable that will receive the return error code from this function.

USB_D_ERR_NONE: OS error code(s) relevant to failure(s)

CALLERS

USB_D_HID_Rd()

USB_D_HID_RdAsync()

USB_D_HID_ClassReq()

IMPLEMENTATION GUIDELINES

The lock operation typically consists in pending on a semaphore. If the semaphore is free, the task continues normally its execution, otherwise it waits until another task releases the semaphore. **p_err** argument should be assigned as described in Table D-3.

Operation result	Error code to assign
No error	USB_D_ERR_NONE
Pend aborted	USB_D_ERR_OS_ABORT
Pend failed for any other reason	USB_D_ERR_OS_FAIL

Table D-3 **p_err** assignment according to the pend operation result

D-2-8 USBD_HID_OS_OutputUnlock()

Unlock class output report.

FILES

usbd_hid_os.c

PROTOTYPE

```
void USBD_HID_OS_OutputUnlock (CPU_INT08U class_nbr);
```

ARGUMENTS

`class_nbr` Class instance number.

CALLERS

USB_HID_Rd()

USB_HID_RdAsync()

USB_HID_ClassReq()

IMPLEMENTATION GUIDELINES

The unlock operation simply consists in posting a semaphore.

D-2-9 USBD_HID_OS_OutputDataPend()

Wait for Output report data read completion.

FILES

usbd_hid_os.c

PROTOTYPE

```
void USBD_HID_OS_OutputDataPend (CPU_INT08U  class_nbr
                                  CPU_INT16U  timeout_ms,
                                  USBD_ERR    *p_err);
```

ARGUMENTS

class_nbr Class instance number.

timeout_ms Signal wait timeout in milliseconds

p_err Pointer to variable that will receive the return error code from this function.

 USB_D_ERR_NONE

 OS error code(s) relevant to failure(s)

CALLERS

USB_D_HID_Rd()

IMPLEMENTATION GUIDELINES

The wait operation typically consists of pending on a semaphore. When the output report transfer is complete, the task is woken up by the Core layer internal task responsible for asynchronous communication. The **p_err** argument should be assigned as described in Table D-2.

Operation result	Error code to assign
No error	USBD_ERR_NONE
Pend aborted	USBD_ERR_OS_ABORT
Pend failed for any other reason	USBD_ERR_OS_FAIL

Table D-4 **p_err** assignment according to the pend operation result

D-2-10 USBD_HID_OS_OutputDataPendAbort()

Abort the wait for Output report data read completion.

FILES

usbd_hid_os.c

PROTOTYPE

```
void USBD_HID_OS_OutputDataPendAbort (CPU_INT08U class_nbr);
```

ARGUMENTS

`class_nbr` Class instance number.

CALLERS

USB_HID_OutputDataCmpl()

IMPLEMENTATION GUIDELINES

If the output report transfer completes with an error, the task waiting is waken up by aborting the active wait done with `USB_HID_OS_OutputDataPend()`. The active wait abortion is executed by the Core layer internal task responsible for asynchronous communication.

D-2-11 USBD_HID_OS_OutputDataPost()

Signal that Output report data has been received from the host

FILES

usbd_hid_os.c

PROTOTYPE

```
void USBD_HID_OS_OutputDataPost (CPU_INT08U class_nbr);
```

ARGUMENTS

class_nbr Class instance number.

CALLERS

USBH_HID_OutputDataCmpl()

IMPLEMENTATION GUIDELINES

If the output report transfer completes without an error, the task waiting is waken up by posting a semaphore. The semaphore post is executed by the Core layer internal task responsible for asynchronous communication.

D-2-12 USBD_HID_OS_TxLock()

Lock class transmit.

FILES

usbd_hid_os.c

PROTOTYPE

```
void USBD_HID_OS_TxLock (CPU_INT08U  class_nbr,
                        USBD_ERR      *p_err);
```

ARGUMENTS

class_nbr Class instance number.

p_err Pointer to variable that will receive the return error code from this function.

USBD_ERR_NONE: OS error code(s) relevant to failure(s).

CALLERS

USBD_HID_Wr ()

USBD_HID_WrAsync ()

IMPLEMENTATION GUIDELINES

The lock operation typically consists in pending on a semaphore. If the semaphore is free, the task continues normally its execution, otherwise it waits until another task releases the semaphore. **p_err** argument should be assigned as described in Table D-5.

Operation result	Error code to assign
No error	USBD_ERR_NONE
Pend aborted	USBD_ERR_OS_ABORT
Pend failed for any other reason	USBD_ERR_OS_FAIL

Table D-5 **p_err** assignment according to the pend operation result

D-2-13 USBD_HID_OS_TxUnlock()

Unlock class transmit.

FILES

usbd_hid_os.c

PROTOTYPE

```
void USBD_HID_OS_TxUnlock (CPU_INT08U class_nbr);
```

ARGUMENTS

`class_nbr` Class instance number.

CALLERS

USB_HID_Wr()

USB_HID_WrAsync()

IMPLEMENTATION GUIDELINES

The unlock operation simply consists in posting a semaphore.

D-2-14 USBD_HID_OS_TmrTask()

Process periodic input reports according to idle duration set by the host with the SET_IDLE request.

FILES

usbd_hid_os.c

PROTOTYPE

```
static void USBD_HID_OS_TmrTask (void *p_arg);
```

ARGUMENTS

p_arg Pointer to task initialization argument.

CALLERS

This is a task.

IMPLEMENTATION GUIDELINES

The task body is usually implemented as an infinite loop. The task should perform the following steps:

- Delay for 4 ms. This delay corresponds to the 4 ms unit used to express the idle duration transported by the SET_IDLE request.
- Call `USBD_HID_Report_TmrTaskHandler()` function defined in the HID parser module. This function implements the periodic input reports processing.

E

MSC API Reference

This appendix provides a reference to the mass storage class API. Each user-accessible service is presented following a category order (i.e. initialization and communication categories). The following information is provided for each of the services:

- A brief description
- The function prototype
- The filename of the source code
- A description of the arguments passed to the function
- A description of returned value(s)
- Specific notes and warnings regarding use of the service.

E-1 MASS STORAGE CLASS FUNCTIONS

E-1-1 USBD_MSC_Init()

Initialize internal structures and local global variables used by the MSC bulk only transport.

FILES

usbd_msc.h / usbd_msc.c

PROTOTYPE

```
void USBD_MSC_Init (USB_ERR *p_err);
```

ARGUMENTS

p_err Pointer to variable that will receive the return error code from this function: **USB_ERR_NONE**

RETURNED VALUE

None.

CALLERS

Application.

NOTES / WARNINGS

None.

E-1-2 USBD_MSC_Add()

Create a new instance of the MSC.

FILES

usbd_msc.h / usbd_msc.c

PROTOTYPE

```
CPU_INT08U USBD_MSC_Add ( USBD_ERR *p_err )
```

ARGUMENTS

p_err Pointer to variable that will receive the return error code from this function.

USB_ERR_NONE
USB_ERR_ALLOC

RETURNED VALUE

Class instance number, if NO error(s).

USBD_CLASS_NBR_NONE, otherwise.

CALLERS

Application.

NOTES / WARNINGS

None.

E-1-3 USBD_MSC_CfgAdd()

Add an existing MSC instance to the specified configuration and device. The MSC instance was previously created by the function `USB_D_MSC_Add()`.

FILES

`usb_d_msc.h` / `usb_d_msc.c`

PROTOTYPE

```
CPU_BOOLEAN USB_D_MSC_CfgAdd (CPU_INT08U   class_nbr,
                               CPU_INT08U   dev_nbr,
                               CPU_INT08U   cfg_nbr,
                               USB_D_ERR    *p_err);
```

ARGUMENTS

`class_nbr` MSC instance number.

`dev_nbr` Device number.

`cfg_nbr` Configuration index to add MSC instance to.

`p_err` Pointer to variable that will receive the return error code from this function.

```
USB_D_ERR_NONE
USB_D_ERR_INVALID_ARG
USB_D_ERR_ALLOC
USB_D_ERR_NULL_PTR
USB_D_ERR_DEV_INVALID_NBR
USB_D_ERR_DEV_INVALID_STATE
USB_D_ERR_CFG_INVALID_NBR
USB_D_ERR_IF_ALLOC
USB_D_ERR_IF_ALT_ALLOC
USB_D_ERR_IF_INVALID_NBR
USB_D_ERR_EP_NONE_AVAIL
USB_D_ERR_EP_ALLOC
```

RETURNED VALUE

DEF_YES, if MSC instance is added to USB device configuration successfully.

DEF_NO, otherwise.

CALLERS

Application.

NOTES / WARNINGS

USBD_MSC_CfgAdd() basically adds an Interface descriptor and its associated Endpoint descriptor(s) to the Configuration descriptor. One call to USBD_MSC_CfgAdd() builds the Configuration descriptor corresponding to a MSC device with the following format:

```
Configuration Descriptor
|-- Interface Descriptor (MSC)
    |-- Endpoint Descriptor (Bulk OUT)
    |-- Endpoint Descriptor (Bulk IN)
```

If USBD_MSC_CfgAdd() is called several times from the application, it allows to create multiple instances and multiple configurations. For instance, the following architecture could be created for an high-speed device:

```
High-speed
|-- Configuration 0
    |-- Interface 0 (MSC 0)
|-- Configuration 1
    |-- Interface 0 (MSC 0)
    |-- Interface 1 (MSC 1)
```

In that example, there are two instances of MSC: 'MSC 0' and 'MSC 1', and two possible configurations for the device: 'Configuration 0' and 'Configuration 1'. 'Configuration 1' is composed of two interfaces. Each class instance has an association with one of the interfaces. If 'Configuration 1' is activated by the host, it allows the host to access two different functionalities offered by the device.

E-1-4 USBD_MSC_LunAdd()

Add a logical unit number to the MSC interface.

FILES

usbcd_msc.h / usbcd_msc.c

PROTOTYPE

```
void USBD_MSC_LunAdd (CPU_CHAR    *p_store_name,
                     CPU_INT08U   class_nbr,
                     CPU_CHAR    *p_vend_id,
                     CPU_CHAR    *p_prod_id,
                     CPU_INT32U   prod_rev_level,
                     CPU_BOOLEAN  rd_only,
                     USBD_ERR     *p_err);
```

ARGUMENTS

<code>p_store_name</code>	Pointer to logical unit driver.
<code>class_nbr</code>	MSC instance number.
<code>p_vend_id</code>	Pointer to string containing vendor id.
<code>p_prod_id</code>	Pointer to string containing product id.
<code>prod_rev_level</code>	Product revision level.
<code>rd_only</code>	Boolean specifying if logical unit is read only or not.
<code>p_err</code>	Pointer to variable that will receive the return error code from this function.
	<code>USB_D_ERR_NONE</code>
	<code>USB_D_ERR_INVALID_ARG</code>
	<code>USB_D_ERR_MSC_MAX_LUN_EXCEED</code>
	<code>USB_D_ERR_SCSI_LOG_UNIT_NOTRDY</code>

RETURNED VALUE

None.

CALLERS

Application.

NOTES / WARNINGS

The pointer to logical unit driver specifies the type and volume of the logical unit to add. Valid logical unit driver names follow the pattern:

`<device_driver_name>:<logical_unit_number>:`

where `<device_driver_name>` is the name of the device driver and `<logical_unit_number>` is the device's logical unit number. Take special note that the logical unit number starts counting from number 0.

E-1-5 USBD_MSC_IsConn()

Get MSC connection state of the device.

FILES

usbdc_msc.h / usbdc_msc.c

PROTOTYPE

```
CPU_BOOLEAN USBDC_MSC_IsConn (CPU_INT08U class_nbr);
```

ARGUMENTS

class_nbr MSC instance number.

RETURNED VALUE

DEF_YES, if MSC is connected.

DEF_NO, otherwise.

CALLERS

Application.

NOTES / WARNINGS

USBDC_MSC_IsConn() is typically used to verify that the device is in 'configured' state and that the MSC instance is ready for communication. The following code illustrates a typical example:

```
CPU_BOOLEAN conn;

conn = USBDC_MSC_IsConn(class_nbr);
if (conn != DEF_YES) {
    USBDC_MSC_OS_EnumSignalPend((CPU_INT16U)0,
                               &os_err);
}
```

Once the connected status is DEF_YES, the communication can start.

E-1-6 USBD_MSC_TaskHandler()

Task to handle transfers for the MSC bulk-only transport protocol.

FILES

usb_d_msc.h / usb_d_msc.c

PROTOTYPE

```
void USBD_MSC_TaskHandler (CPU_INT08U class_nbr);
```

ARGUMENTS

`class_nbr` MSC instance number.

RETURNED VALUE

None.

CALLERS

OS layer.

NOTES / WARNINGS

None.

E-2 MSC OS FUNCTIONS

E-2-1 USBD_MSC_OS_Init()

Initialize MSC OS interface.

FILES

usbd_msc_os.h / usbd_msc_os.c

PROTOTYPE

```
void USBD_MSC_OS_Init (USB_ERR *p_err)
```

ARGUMENTS

p_err Pointer to variable that will receive the return error code from this function.

USB_ERR_NONE

USB_ERR_OS_FAIL

RETURNED VALUE

None.

CALLERS

USBD_OS_Init()

IMPLEMENTATION GUIDELINES

Initialization of the MSC OS interface must include creating:

1. Two semaphores, one for MSC communication and one for enumeration.
2. A MSC task to handle the MSC protocol.

E-2-2 USBD_MSC_OS_CommSignalPost()

Post a semaphore used for MSC communication.

FILES

usbd_msc_os.h / usbd_msc_os.c

PROTOTYPE

```
void USBD_MSC_OS_CommSignalPost (CPU_INT08U  class_nbr,  
                                USBD_ERR     *p_err)
```

ARGUMENTS

class_nbr MSC instance class number.

p_err Pointer to variable that will receive the return error code from this function.

USB_ERR_NONE

USB_ERR_OS_FAIL

RETURNED VALUE

None.

CALLERS

Various.

NOTES / WARNINGS

None.

E-2-3 USBD_MSC_OS_CommSignalPend()

Wait on a semaphore to become available for MSC communication.

FILES

usbd_msc_os.h / usbd_msc_os.c

PROTOTYPE

```
void USBD_MSC_OS_CommSignalPend (CPU_INT08U class_nbr,  
                                CPU_INT32U timeout,  
                                USBD_ERR *p_err);
```

ARGUMENTS

class_nbr MSC instance class number.

timeout Timeout in milliseconds.

p_err Pointer to variable that will receive the return error code from this function.

USB_ERR_NONE
USB_ERR_OS_TIMEOUT
USB_ERR_OS_FAIL

RETURNED VALUE

None.

CALLERS

Various.

NOTES / WARNINGS

None.

E-2-4 USBD_MSC_OS_CommSignalDel()

Delete a semaphore if no tasks are waiting on it for MSC communication.

FILES

usbd_msc_os.h / usbd_msc_os.c

PROTOTYPE

```
void USBD_MSC_OS_CommSignalDel (CPU_INT08U class_nbr,  
                                USBD_ERR *p_err);
```

ARGUMENTS

class_nbr MSC instance class number.

p_err Pointer to variable that will receive the return error code from this function.

USB_ERR_NONE

USB_ERR_OS_FAIL

RETURNED VALUE

None.

CALLERS

Various.

NOTES / WARNINGS

None.

E-2-5 USBD_MSC_OS_EnumSignalPost()

Post a semaphore for MSC enumeration process.

FILES

usbd_msc_os.h / usbd_msc_os.c

PROTOTYPE

```
void USBD_MSC_OS_EnumSignalPost (USB_ERR *p_err);
```

ARGUMENTS

p_err Pointer to variable that will receive the return error code from this function.

USB_ERR_NONE

USB_ERR_OS_FAIL

RETURNED VALUE

None.

CALLERS

Various.

NOTES / WARNINGS

None.

E-2-6 USBD_MSC_OS_EnumSignalPend()

Wait on a semaphore to become available for MSC enumeration process.

FILES

usbdc_msc_os.h / usbdc_msc_os.c

PROTOTYPE

```
void USBD_MSC_OS_EnumSignalPend (CPU_INT32U timeout,  
                                USBD_ERR *p_err);
```

ARGUMENTS

timeout Timeout in milliseconds.

p_err Pointer to variable that will receive the return error code from this function.

USBDC_ERR_NONE

USBDC_ERR_OS_TIMEOUT

USBDC_ERR_OS_FAIL

RETURNED VALUE

None.

CALLERS

Various.

NOTES / WARNINGS

None.

E-3 MSC STORAGE LAYER FUNCTIONS

E-3-1 USBD_StorageInit()

Initialize internal structures and local global variables used by the storage medium.

FILES

usb_storage.h / usb_storage.c

PROTOTYPE

```
void USBD_StorageInit (USB_STORAGE_LUN *p_storage_lun);
                        USB_ERR        *p_err)
```

ARGUMENTS

p_storage_lun Pointer to logical unit storage structure.

p_err Pointer to variable that will receive the return error code from this function.

```
USB_ERR_NONE
USB_ERR_MEDIUM_NOT_PRESENT
USB_ERR_SCSI_LOG_UNIT_NOTRDY
USB_ERR_SCSI_LOG_UNIT_NOTSUPPORTED
USB_ERR_SCSI_LOG_UNIT_BUSY
```

RETURNED VALUE

None.

CALLERS

USB_SCSI_Init()

NOTES / WARNINGS

None.

E-3-2 USBD_StorageCapacityGet()

Get the capacity of the storage medium.

FILES

usbd_storage.h / usbd_storage.c

PROTOTYPE

```
void USBD_StorageCapacityGet (USB_STORAGE_LUN *p_storage_lun),
                             CPU_INT64U      *p_nbr_blks,
                             CPU_INT32U      *p_blk_size,
                             USBD_ERR        *p_err)
```

ARGUMENTS

p_storage_lun Pointer to logical unit storage structure.

p_nbr_blks Pointer to variable that will receive the number of logical blocks.

p_blk_size Pointer to variable that will receive the size of each block, in bytes.

p_err Pointer to variable that will receive the return error code from this function.

USB_ERR SCSI_MEDIUM_NOTPRESENT

USB_ERR_NONE

RETURNED VALUE

None.

CALLERS

USBD_SCSI_IssueCmd()

NOTES / WARNINGS

None.

E-3-3 USBD_StorageRd()

Read data from the storage medium.

FILES

usb_storage.h / usb_storage.c

PROTOTYPE

```
void USBD_StorageRd (USB_STORAGE_LUN *p_storage_lun,  
                    CPU_INT32U      blk_addr,  
                    CPU_INT32U      nbr_blks,  
                    CPU_INT08U      *p_data_buf,  
                    USBD_ERR        *p_err);
```

ARGUMENTS

p_storage_lun Pointer to the logical unit storage structure.

blk_addr Logical Block Address (LBA) of read block start.

nbr_blks Number of logical blocks to read.

p_data_buf Pointer to buffer in which data will be stored.

p_err Pointer to variable that will receive the return error code from this function.

USB_ERR_NONE

USB_ERR_SCSI_MEDIUM_NOT_PRESENT

RETURNED VALUE

None.

CALLERS

USB_SCSI_RdData()

NOTES / WARNINGS

None.

E-3-4 USBD_StorageWr()

Write data to the storage medium.

FILES

usb_storage.h / usb_storage.c

PROTOTYPE

```
void USBD_StorageWr (USB_STORAGE_LUN *p_storage_lun,  
                    CPU_INT32U      blk_addr,  
                    CPU_INT32U      nbr_blks,  
                    CPU_INT08U      *p_data_buf,  
                    USBD_ERR         *p_err);
```

ARGUMENTS

p_storage_lun Pointer to logical unit storage structure

blk_addr Logical Block Address (LBA) of write block start.

nbr_blks Number of logical blocks to write.

p_data_buf Pointer to buffer in which data is stored.

p_err Pointer to variable that will receive the return error code from this function.

USB_ERR_NONE

USB_ERR_SCSI_MEDIUM_NOTPRESENT

RETURNED VALUE

None.

CALLERS

USB_SCSI_WrData()

NOTES / WARNINGS

None.

E-3-5 USBD_StorageStatusGet()

Get the presence of the storage medium.

FILES

usb_storage.h / usb_storage.c

PROTOTYPE

```
void USBD_StorageStatusGet (USB_STORAGE_LUN *p_storage_lun,  
                           USB_ERR *p_err);
```

ARGUMENTS

p_storage_lun Pointer to logical unit storage structure

p_err Pointer to variable that will receive the return error code from this function.

```
USB_ERR_NONE  
USB_ERR_SCSI_MEDIUM_NOTPRESENT  
USB_ERR_SCSI_MEDIUM_NOT_RDY_TO_RDY  
USB_ERR_SCSI_MEDIUM_RDY_TO_NOT_RDY
```

RETURNED VALUE

None.

CALLERS

USB_SCSI_IssueCmd()

NOTES / WARNINGS

None.

F

PHDC API Reference

This appendix provides a reference to the Personal Healthcare Device Class (PHDC) API. Each user-accessible service is presented following a category order (i.e. initialization, communication and RTOS layer categories). The following information is provided for each of the services:

- A brief description
- The function prototype
- The filename of the source code
- A description of the arguments passed to the function
- A description of returned value(s)

Specific notes and warnings regarding use of the service.

F-1 PHDC FUNCTIONS

F-1-1 USBD_PHDC_Init()

Initialize internal structures and local global variables used by the PHDC.

FILES

usbd_phdc.h / usbd_phdc.c

PROTOTYPE

```
void USBD_PHDC_Init (USB_ERR *p_err);
```

ARGUMENTS

p_err Pointer to variable that will receive the return error code from this function.

USB_ERR_NONE

RETURNED VALUE

None.

CALLERS

Application.

NOTES / WARNINGS

None.

F-1-2 USBD_PHDC_Add()

Create a new instance of the PHDC.

FILES

usbd_phdc.h / usbd_phdc.c

PROTOTYPE

```
CPU_INT08U  USBD_PHDC_Add (CPU_BOOLEAN          data_fmt_11073,
                          CPU_BOOLEAN          preamble_capable,
                          USBD_PHDC_PREAMBLE_EN_NOTIFY preamble_en_notify,
                          CPU_INT16U         low_latency_interval,
                          USBD_ERR           *p_err)
```

ARGUMENTS

<code>data_fmt_11073</code>	Variable that indicates whether the class instance uses IEEE 11073 or a vendor-defined data format.
<code>DEF_YES</code>	Class instance uses IEEE 11073 data format.
<code>DEF_NO</code>	Class instance uses vendor-defined data format.
<code>preamble_capable</code>	Variable that indicates whether the class instance support metadata message preamble or not.
<code>DEF_YES</code>	Class instance support metadata message preamble.
<code>DEF_NO</code>	Class instance doesn't support metadata message preamble.
<code>preamble_en_notify</code>	Pointer to a callback function that will notify the application if the host enable / disable metadata message preamble.
<code>low_latency_interval</code>	Interrupt endpoint interval in frames or microframes. Can be 0 if PHDC device will not send low latency data.

p_err Pointer to variable that will receive the return error code from this function.

USBD_ERR_NONE
 USBD_ERR_ALLOC

RETURNED VALUE

Class instance number, if NO error(s).

USBD_CLASS_NBR_NONE, otherwise.

CALLERS

Application.

NOTES / WARNINGS

None.

F-1-3 USBD_PHDC_CfgAdd()

Add a PHDC instance into the specified configuration. The PHDC instance was previously created by the function `USB_DPHDC_ADD()`.

FILES

`usb_dphdc.h` / `usb_dphdc.c`

PROTOTYPE

```
void USBD_PHDC_CfgAdd (CPU_INT08U   class_nbr,
                      CPU_INT08U   dev_nbr,
                      CPU_INT08U   cfg_nbr,
                      USBD_ERR      *p_err);
```

ARGUMENTS

<code>class_nbr</code>	PHDC instance number.
<code>dev_nbr</code>	Device number.
<code>cfg_nbr</code>	Configuration index to add PHDC instance to.
<code>p_err</code>	Pointer to variable that will receive the return error code from this function.

```
USB_DERR_NONE
USB_DERR_INVALID_ARG
USB_DERR_ALLOC
USB_DERR_NULL_PTR
USB_DERR_DEV_INVALID_NBR
USB_DERR_DEV_INVALID_STATE
USB_DERR_CFG_INVALID_NBR
USB_DERR_IF_ALLOC
USB_DERR_IF_ALT_ALLOC
USB_DERR_IF_INVALID_NBR
USB_DERR_EP_NONE_AVAIL
USB_DERR_EP_ALLOC
```

RETURNED VALUE

None.

CALLERS

Application.

NOTES / WARNINGS

`USBD_PHDC_CfgAdd()` basically adds an Interface descriptor and its associated Endpoint descriptor(s) to the Configuration descriptor. One call to `USBD_PHDC_CfgAdd()` builds the Configuration descriptor corresponding to a PHDC device with the following format:

Configuration Descriptor

```
|-- Interface Descriptor (PHDC)
    |-- Endpoint Descriptor (Bulk OUT)
    |-- Endpoint Descriptor (Bulk IN)
    |-- Endpoint Descriptor (Interrupt IN) - optional
```

The Interrupt IN endpoint is optional. It will be added to the Interface descriptor if application specified that it will send low latency data when calling `USBD_PHDC_WrCfg()`.

If `USBD_PHDC_CfgAdd()` is called several times from the application, it allows to create multiple instances and multiple configurations. For instance, the following architecture could be created for an high-speed device:

High-speed

```
|-- Configuration 0
    |-- Interface 0 (PHDC 0)
|-- Configuration 1
    |-- Interface 0 (PHDC 0)
    |-- Interface 1 (PHDC 1)
```

In that example, there are two instances of PHDC: 'PHDC 0' and 'PHDC 1', and two possible configurations for the device: 'Configuration 0' and 'Configuration 1'. 'Configuration 1' is composed of two interfaces. Each class instance has an association with one of the interfaces. If 'Configuration 1' is activated by the host, it allows the host to access two different functionalities offered by the device.

F-1-4 USBD_PHDC_IsConn()

Get PHDC connection state.

FILES

usbdc_phdc.h / usbdc_phdc.c

PROTOTYPE

```
CPU_BOOLEAN USBD_PHDC_IsConn (CPU_INT08U class_nbr);
```

ARGUMENTS

`class_nbr` PHDC instance number.

RETURNED VALUE

`DEF_YES`, if PHDC is connected.

`DEF_NO`, otherwise.

CALLERS

Application.

NOTES / WARNINGS

`USBDC_PHDC_IsConn()` is typically used to verify that the device is in 'configured' state and that the PHDC instance is ready for communication. The following code illustrates a typical example:

```
CPU_BOOLEAN conn;

conn = USBDC_PHDC_IsConn(class_nbr);
while (conn != DEF_YES) {
    OSTimeDlyHMSM(0, 0, 0, 250);

    conn = USBDC_PHDC_IsConn(class_nbr);
}
```

Once the connected status is `DEF_YES`, the communication can start.

F-1-5 USBD_PHDC_RdCfg()

Initialize read communication pipe parameters.

FILES

usbd_phdc.h / usbd_phdc.c

PROTOTYPE

```
void USBD_PHDC_RdCfg (CPU_INT08U      class_nbr,
                     LATENCY_RELY_FLAGS latency_rely,
                     CPU_INT08U      *p_data_opaque,
                     CPU_INT08U      data_opaque_len,
                     USBD_ERR        *p_err);
```

ARGUMENTS

class_nbr PHDC instance number.

latency_rely Bitmap of transfer latency / reliability that this communication pipe will carry. Can be one or more of these values:

```
USBD_PHDC_LATENCY_VERYHIGH_RELY_BEST
USBD_PHDC_LATENCY_HIGH_RELY_BEST
USBD_PHDC_LATENCY_MEDIUM_RELY_BEST
```

p_data_opaque Pointer to a buffer that contains opaque data related to this communication pipe.

data_opaque_len Length of opaque data (in octets). If 0, no metadata descriptor will be written for the endpoint.

p_err Pointer to variable that will receive the return error code from this function.

```
USBD_ERR_NONE
USBD_ERR_NULL_PTR
USBD_ERR_INVALID_ARG
```

RETURNED VALUE

None.

CALLERS

Application.

NOTES / WARNINGS

USBD_PHDC_RdCfg() should be called after USBD_PHDC_Init() and USBD_PHDC_Add() but before USBD_PHDC_CfgAdd().

F-1-6 USBD_PHDC_WrCfg()

Initialize write communication pipe parameters.

FILES

usbd_phdc.h / usbd_phdc.c

PROTOTYPE

```

void USBD_PHDC_WrCfg (CPU_INT08U      class_nbr,
                     LATENCY_RELY_FLAGS latency_rely,
                     CPU_INT08U      *p_data_opaque,
                     CPU_INT08U      data_opaque_len,
                     USBD_ERR        *p_err);

```

ARGUMENTS

class_nbr PHDC instance number.

latency_rely Bitmap of transfer Latency / reliability that this communication pipe will carry. Can be one or more of these values:

```

USB_DPHDC_LATENCY_VERYHIGH_RELY_BEST
USB_DPHDC_LATENCY_HIGH_RELY_BEST
USB_DPHDC_LATENCY_MEDIUM_RELY_BEST
USB_DPHDC_LATENCY_MEDIUM_RELY_BETTER
USB_DPHDC_LATENCY_MEDIUM_RELY_GOOD
USB_DPHDC_LATENCY_LOW_RELY_GOOD

```

p_data_opaque Pointer to a buffer that contains opaque data related to this communication pipe.

data_opaque_len Length of opaque data (in octets). If 0, no metadata descriptor will be written for the endpoint.

p_err Pointer to variable that will receive the return error code from this function.

`USBD_ERR_NONE`

`USBD_ERR_NULL_PTR`

`USBD_ERR_INVALID_ARG`

RETURNED VALUE

None.

CALLERS

Application.

NOTES / WARNINGS

`USBD_PHDC_WrCfg()` should be called after `USBD_PHDC_Init()` and `USBD_PHDC_Add()` but before `USBD_PHDC_CfgAdd()`.

Since low latency transfers will use a different endpoint, it is possible to set different opaque data for that endpoint. In case the application need different opaque data for low latency pipe, `USBD_PHDC_WrCfg()` should be called twice. Once with all the desired latency/reliability flags set except for low latency, opaque data passed at this call will be used for the Bulk endpoint metadata descriptor. `USBD_PHDC_WrCfg()` should then be called once again with only the low latency flag set, opaque data passed at this call will be used for interrupt endpoint metadata descriptor.

F-1-7 USBD_PHDC_11073_ExtCfg()

Configure function extension for given class instance.

FILES

usbd_phdc.h / usbd_phdc.c

PROTOTYPE

```
void USBD_PHDC_11073_ExtCfg (CPU_INT08U   class_nbr,  
                             CPU_INT16U   *p_dev_specialization,  
                             CPU_INT08U   nbr_dev_specialization,  
                             USBD_ERR     *p_err);
```

ARGUMENTS

<code>class_nbr</code>	PHDC instance number.
<code>p_dev_specialization</code>	Pointer to an array that contains a list of device specializations.
<code>nbr_dev_specialization</code>	Number of device specializations specified in <code>p_dev_specialization</code> .
<code>p_err</code>	Pointer to variable that will receive the return error code from this function.

USB_ERR_NONE
USB_ERR_INVALID_ARG

RETURNED VALUE

None.

CALLERS

Application.

NOTES / WARNINGS

`USBD_PHDC_11073_ExtCfg()` should be called only if PHDC instance uses 11073 data format.

`USBD_PHDC_11073_ExtCfg()` should be called after `USBD_PHDC_Init()` and `USBD_PHDC_Add()` but before `USBD_PHDC_CfgAdd()`.

For more information on 11073 device specialization, See 'Personal Healthcare Device Class specifications Revision 1.0', Appendix A. For a list of known device specialization, see 'Nomenclature code annex of ISO/IEEE 11073-20601'. Specific code are listed in the 'From Communication infrastructure (MDC_PART_INFRA)' section.

F-1-8 USBD_PHDC_RdPreamble()

Read metadata preamble. This function is blocking.

FILES

usbdc_phdc.h / usbdc_phdc.c

PROTOTYPE

```

CPU_INT08U  USBD_PHDC_RdPreamble (CPU_INT08U  class_nbr,
                                   void         *p_buf,
                                   CPU_INT08U  buf_len,
                                   CPU_INT08U  *p_nbr_xfer,
                                   CPU_INT16U  timeout,
                                   USBD_ERR    *p_err);

```

ARGUMENTS

<code>class_nbr</code>	PHDC instance number.
<code>p_buf</code>	Pointer to buffer that will contain data from metadata message preamble.
<code>buf_len</code>	Opaque data buffer length in octets.
<code>p_nbr_xfer</code>	Pointer to a variable that will contain the number of transfer the preamble will apply to. After this call, <code>USBDC_PHDC_Rd</code> shall be called <code>nbr_xfer</code> times by the application.
<code>timeout</code>	Timeout in milliseconds.
<code>p_err</code>	Pointer to variable that will receive the return error code from this function.

```

USBDC_ERR_NONE
USBDC_ERR_INVALID_CLASS_STATE
USBDC_ERR_INVALID_ARG
USBDC_ERR_NULL_PTR
USBDC_ERR_ALLOC
USBDC_ERR_RX

```

```
USBD_ERR_DEV_INVALID_NBR
USBD_ERR_EP_INVALID_NBR
USBD_ERR_DEV_INVALID_STATE
USBD_ERR_EP_INVALID_TYPE
USBD_OS_ERR_TIMEOUT
USBD_OS_ERR_ABORT
USBD_OS_ERR_FAIL
```

RETURNED VALUE

Length of opaque data read from metadata preamble, if no error.

0, otherwise

CALLERS

Application.

NOTES / WARNINGS

`USBD_PHDC_RdPreamble()` should always be called before `USBD_PHDC_Rd()` if metadata message preambles are enabled by the host. Application should then call `USBD_PHDC_Rd()` `p_nbr_xfer` times.

If host disable preamble while application is pending on this function, the call will immediately return with error 'USBD_OS_ERR_ABORT'.

F-1-9 USBD_PHDC_Rd()

Read PHDC data. This function is blocking.

FILES

usbd_phdc.h / usbd_phdc.c

PROTOTYPE

```

CPU_INT08U  USBD_PHDC_Rd (CPU_INT08U  class_nbr,
                          void          *p_buf,
                          CPU_INT16U   buf_len,
                          CPU_INT16U   timeout,
                          USBD_ERR     *p_err);

```

ARGUMENTS

class_nbr PHDC instance number.

p_buf Pointer to buffer that will contain opaque data from metadata message preamble.

buf_len Opaque data buffer length in octets.

timeout Timeout in milliseconds.

p_err Pointer to variable that will receive the return error code from this function.

```

USB_D_ERR_NONE
USB_D_ERR_INVALID_CLASS_STATE
USB_D_ERR_INVALID_ARG
USB_D_ERR_NULL_PTR
USB_D_ERR_RX
USB_D_ERR_DEV_INVALID_NBR
USB_D_ERR_EP_INVALID_NBR
USB_D_ERR_DEV_INVALID_STATE
USB_D_ERR_EP_INVALID_TYPE
USB_OS_ERR_TIMEOUT
USB_OS_ERR_ABORT
USB_OS_ERR_FAIL

```

RETURNED VALUE

Number of octets received, if no error(s).

0, otherwise.

CALLERS

Application.

NOTES / WARNINGS

`USBD_PHDC_Rd()` should always be called after `USBD_PHDC_RdPreamble()` if metadata message preambles are enabled by the host.

Application should ensure that the length of the buffer provided is large enough to accommodate the incoming transfer. Otherwise, synchronization with metadata preambles might be lost.

If host enable preamble while application is pending on this function, the call will immediately return with error `'USBD_OS_ERR_ABORT'`.

F-1-10 USBD_PHDC_Wrpreamble()

Write metadata preamble. This function is blocking.

FILES

usbdc_phdc.h / usbdc_phdc.c

PROTOTYPE

```
void USBD_PHDC_Wrpreamble (CPU_INT08U      class_nbr,
                           void            *p_data_opaque,
                           CPU_INT16U     data_opaque_len,
                           LATENCY_RELY_FLAGS latency_rely,
                           CPU_INT08U     nbr_xfers,
                           CPU_INT16U     timeout,
                           USBD_ERR       *p_err);
```

ARGUMENTS

class_nbr PHDC instance number.

p_data_opaque Pointer to buffer that will supply opaque data.

data_opaque_len Length of opaque data buffer in octets.

latency_rely Latency reliability of related transfers.

nbr_xfers Number of transfers this preamble will apply to.

timeout Timeout in milliseconds.

p_err Pointer to variable that will receive the return error code from this function.

```
USBDC_ERR_NONE
USBDC_ERR_INVALID_ARG
USBDC_ERR_NULL_PTR
USBDC_ERR_TX
USBDC_ERR_DEV_INVALID_NBR
```

```
USB_ERR_DEV_INVALID_STATE
USB_ERR_EP_INVALID_ADDR
USB_ERR_EP_INVALID_STATE
USB_ERR_EP_INVALID_TYPE
USB_OS_ERR_TIMEOUT
USB_OS_ERR_ABORT
USB_OS_ERR_FAIL
```

RETURNED VALUE

None.

CALLERS

Application.

NOTES / WARNINGS

`USB_PHDC_WrPreamble()` should always be called before `USB_PHDC_Wr()` if metadata message preambles are enabled by the host and if the latency of the transfer is not 'low'.

Application will have to call `USB_PHDC_Wr()` 'nbr_xfers' of times with the same latency / reliability parameter after a call to `USB_PHDC_WrPreamble()`.

F-1-11 USBD_PHDC_Wr()

Write PHDC data. This function is blocking.

FILES

usbd_phdc.h / usbd_phdc.c

PROTOTYPE

```
void USBD_PHDC_Wr (CPU_INT08U      class_nbr,
                  void             *p_buf,
                  CPU_INT16U      buf_len,
                  LATENCY_RELY_FLAGS latency_rely
                  CPU_INT16U      timeout,
                  USBD_ERR        *p_err);
```

ARGUMENTS

<code>class_nbr</code>	PHDC instance number.
<code>p_buf</code>	Pointer to buffer that will supply data.
<code>buf_len</code>	Buffer length in octets.
<code>latency_rely</code>	Latency / reliability of this transfer.
<code>timeout</code>	Timeout in milliseconds.
<code>p_err</code>	Pointer to variable that will receive the return error code from this function.

```
USB_D_ERR_NONE
USB_D_ERR_INVALID_ARG
USB_D_ERR_NULL_PTR
USB_D_ERR_TX
USB_D_ERR_INVALID_CLASS_STATE
USB_D_ERR_DEV_INVALID_NBR
USB_D_ERR_DEV_INVALID_STATE
USB_D_ERR_EP_INVALID_ADDR
```

USBD_ERR_EP_INVALID_STATE
USBD_ERR_EP_INVALID_TYPE
USBD_OS_ERR_TIMEOUT
USBD_OS_ERR_ABORT
USBD_OS_ERR_FAIL

RETURNED VALUE

None.

CALLERS

Application.

NOTES / WARNINGS

`USBD_PHDC_Wr()` should always be called after `USBD_PHDC_WrPreamble()` if metadata message preambles are enabled by the host and if the latency of the transfer is not 'low'.

Application will have to call `USBD_PHDC_Wr()` 'nbr_xfers' of times with the same latency / reliability parameter after a call to `USBD_PHDC_WrPreamble()`.

F-1-12 USBD_PHDC_Reset()

Reset PHDC instance.

FILES

usbdc_phdc.h / usbdc_phdc.c

PROTOTYPE

```
void USBD_PHDC_Reset (CPU_INT08U class_nbr);
```

ARGUMENTS

`class_nbr` PHDC instance number.

RETURNED VALUE

None.

CALLERS

USBDC_PHDC_Disconn() and Application.

NOTES / WARNINGS

USBDC_PHDC_Reset() should be used to reset internal variables like the transmit priority queue of the PHDC instance.

This function should be called when the data layer above PHDC request to terminate communication. For instance, USBDC_PHDC_Reset() should be called when the host send an '11073 Association abort' request.

F-2 PHDC OS LAYER FUNCTIONS

F-2-1 USBD_PHDC_OS_Init()

Initialize PHDC OS layer.

FILES

usbdc_phdc_os.h / usbdc_phdc_os.c

PROTOTYPE

```
void USBD_PHDC_OS_Init (USBDC_ERR *p_err);
```

ARGUMENTS

p_err Pointer to variable that will receive the return error code from this function.

RETURNED VALUE

None.

CALLERS

USBDC_PHDC_Init()

IMPLEMENTATION GUIDELINES

This function should be used to initialize all RTOS layer's internal variables / tasks of every class instances. It will be called only once.

In case creation of semaphore, mutex, or other signal fails, the function should assign `USBDC_ERR_OS_SIGNAL_CREATE` to `p_err` and return immediately. If any other error occurs, `USBDC_ERR_OS_INIT_FAIL` should be assigned to `p_err`. Otherwise, `USBDC_ERR_NONE` should be used.

F-2-2 USBD_PHDC_OS_RdLock()

Lock the read pipe.

FILES

usbdc_phdc_os.h / usbdc_phdc_os.c

PROTOTYPE

```
void USBD_PHDC_OS_RdLock (CPU_INT08U class_nbr,  
                          CPU_INT16U timeout,  
                          USBD_ERR *p_err);
```

ARGUMENTS

class_nbr PHDC instance number.

timeout Timeout.

p_err Pointer to variable that will receive the return error code from this function.

RETURNED VALUE

None.

CALLERS

USBDC_PHDC_Rd(), USBDC_PHDC_RdPreamble()

IMPLEMENTATION GUIDELINES

Typical implementation will consist in pending on a semaphore that locks the read pipe.

p_err argument should be assigned as described in Table F-1.

Operation result	Error code to assign
No error	USBD_ERR_NONE
Pend timeout	USBD_ERR_OS_TIMEOUT
Pend aborted	USBD_ERR_OS_ABORT
Pend failed for any other reason	USBD_ERR_OS_FAIL

Table F-1 **p_err** assignment in function of operation result

F-2-3 USBD_PHDC_OS_RdUnlock()

Unlock the read pipe.

FILES

usb_d_phdc_os.h / usb_d_phdc_os.c

PROTOTYPE

```
void USBD_PHDC_OS_RdUnlock (CPU_INT08U class_nbr);
```

ARGUMENTS

class_nbr PHDC instance number.

RETURNED VALUE

None.

CALLERS

USB_D_PHDC_Rd(), USB_D_PHDC_RdPreamble()

IMPLEMENTATION GUIDELINES

Typical implementation will consist in posting a semaphore that locks the read pipe.

F-2-4 USBD_PHDC_OS_WrIntrLock()

Lock the write interrupt pipe.

FILES

usbdc_phdc_os.h / usbdc_phdc_os.c

PROTOTYPE

```
void USBDC_PHDC_OS_WrIntrLock (CPU_INT08U class_nbr,  
                                CPU_INT16U timeout,  
                                USBDC_ERR *p_err);
```

ARGUMENTS

class_nbr PHDC instance number.

timeout Timeout.

p_err Pointer to variable that will receive the return error code from this function.

RETURNED VALUE

None.

CALLERS

USBDC_PHDC_Wr()

IMPLEMENTATION GUIDELINES

Typical implementation will consist in pending on a semaphore that locks the write interrupt pipe.

p_err argument should be assigned as described in Table F-1.

F-2-5 USBD_PHDC_OS_WrIntrUnLock()

Unlock the write interrupt pipe.

FILES

usbd_phdc_os.h / usbd_phdc_os.c

PROTOTYPE

```
void USBD_PHDC_OS_WrIntrUnLock (CPU_INT08U class_nbr);
```

ARGUMENTS

`class_nbr` PHDC instance number.

RETURNED VALUE

None.

CALLERS

USB_D_PHDC_Wr ()

IMPLEMENTATION GUIDELINES

Typical implementation will consist in posting a semaphore that locks the write interrupt pipe.

F-2-6 USBD_PHDC_OS_WrBulkLock()

Lock the write bulk pipe.

FILES

usbdc_phdc_os.h / usbdc_phdc_os.c

PROTOTYPE

```
void USBD_PHDC_OS_WrBulkLock (CPU_INT08U class_nbr,  
                               CPU_INT08U prio,  
                               CPU_INT16U timeout,  
                               USBD_ERR *p_err);
```

ARGUMENTS

<code>class_nbr</code>	PHDC instance number.
<code>prio</code>	Priority of the transfer. This value is between 0 and 4 and is computed in function of the transfer's QoS by the caller.
<code>timeout</code>	Timeout.
<code>p_err</code>	Pointer to variable that will receive the return error code from this function.

RETURNED VALUE

None.

CALLERS

USBDC_PHDC_Wr(), USBDC_PHDC_WrPreamble().

IMPLEMENTATION GUIDELINES

Two typical implementations will be possible here. The first one consists in pending on a semaphore that locks the write bulk pipe, just as we saw previously.

But since different QoS data can travel using a single bulk IN endpoint, you might want to prioritize them in function of the QoS. See section 11-4 “RTOS QoS-based scheduler” on page 196 for more details on how a priority manager can be implemented.

`p_err` argument should be assigned as described in Table F-1.

F-2-7 USBD_PHDC_OS_WrBulkUnlock()

Unlock the write bulk pipe.

FILES

usbd_phdc_os.h / usbd_phdc_os.c

PROTOTYPE

```
void USBD_PHDC_OS_WrBulkUnlock (CPU_INT08U class_nbr);
```

ARGUMENTS

class_nbr PHDC instance number.

RETURNED VALUE

None.

CALLERS

USB_D_PHDC_Wr ()

IMPLEMENTATION GUIDELINES

Two typical implementations will be possible here. The first one consists in posting the semaphore that locks the write bulk pipe, if no priority management is implemented. However, if priority management has been integrated, this call should release the scheduler (See Section 11-4, “RTOS QoS-based scheduler” on page 196).

G

Vendor Class API Reference

This appendix provides a reference to the Vendor class API. Each user-accessible service is presented following a category order (i.e., initialization and communication categories). The following information is provided for each of the services:

- A brief description
- The function prototype
- The filename of the source code
- A description of the arguments passed to the function
- A description of returned value(s)
- Specific notes and warnings regarding use of the service.

G-1 VENDOR CLASS FUNCTIONS

G-1-1 USBD_Vendor_Init()

Initialize internal structures and local global variables used by the Vendor class.

FILES

usbd_vendor.c

PROTOTYPE

```
void USBD_Vendor_Init (USB_ERR *p_err);
```

ARGUMENTS

p_err Pointer to variable that will receive the return error code from this function.

 USB_ERR_NONE

RETURNED VALUE

None.

CALLERS

Application.

NOTES / WARNINGS

The initialization function *must* be called only once by the application, and before calling any other Vendor API.

G-1-2 USBD_Vendor_Add()

Create a new instance of the Vendor class.

FILES

usbd_vendor.c

PROTOTYPE

```
CPU_INT08U  USBD_Vendor_Add (CPU_BOOLEAN      intr_en,
                             CPU_INT16U      interval,
                             USBD_VENDOR_REQ_FNCT req_callback,
                             USBD_ERR        *p_err);
```

ARGUMENTS

intr_en Interrupt endpoints IN and OUT flag:

DEF_TRUE	Pair of interrupt endpoints added to interface.
DEF_FALSE	Pair of interrupt endpoints not added to interface.

interval Endpoint interval in frames or microframes.

req_callback Vendor-specific request callback.

p_err Pointer to variable that will receive the return error code from this function.

USBD_ERR_NONE
USBD_ERR_INVALID_ARG
USBD_ERR_ALLOC

RETURNED VALUE

Class instance number, if NO error(s).

USBD_CLASS_NBR_NONE, otherwise.

CALLERS

Application.

NOTES / WARNINGS

None.

G-1-3 USBD_Vendor_CfgAdd()

Add a Vendor class instance into the specified configuration. The Vendor class instance was previously created by the function `USB_D_Vendor_Add()`.

FILES

`usb_d_vendor.c`

PROTOTYPE

```
void USB_D_Vendor_CfgAdd (CPU_INT08U      class_nbr,
                        CPU_INT08U      dev_nbr,
                        CPU_INT08U      cfg_nbr,
                        USB_D_ERR      *p_err);
```

ARGUMENTS

`class_nbr` Class instance number.

`dev_nbr` Device number.

`cfg_nbr` Configuration index to add Vendor class instance to.

`p_err` Pointer to variable that will receive the return error code from this function.

```
USB_D_ERR_NONE
USB_D_ERR_INVALID_ARG
USB_D_ERR_ALLOC
USB_D_ERR_NULL_PTR
USB_D_ERR_DEV_INVALID_NBR
USB_D_ERR_DEV_INVALID_STATE
USB_D_ERR_CFG_INVALID_NBR
USB_D_ERR_IF_ALLOC
USB_D_ERR_IF_ALT_ALLOC
USB_D_ERR_IF_INVALID_NBR
USB_D_ERR_EP_NONE_AVAIL
USB_D_ERR_EP_ALLOC
```

RETURNED VALUE

None.

CALLERS

Application.

NOTES / WARNINGS

`USBD_Vendor_CfgAdd()` basically adds an Interface descriptor and its associated Endpoint descriptor(s) to the Configuration descriptor. One call to `USBD_Vendor_CfgAdd()` builds the Configuration descriptor corresponding to a Vendor-specific device with the following format:

Configuration Descriptor

```
|-- Interface Descriptor (Vendor class)
    |-- Endpoint Descriptor (Bulk OUT)
    |-- Endpoint Descriptor (Bulk IN)
    |-- Endpoint Descriptor (Interrupt OUT) - optional
    |-- Endpoint Descriptor (Interrupt IN) - optional
```

The pair of Interrupt endpoints are optional. They can be added to the Interface descriptor by setting the parameter `intr_en` to `DEF_TRUE`.

If `USBD_Vendor_CfgAdd()` is called several times from the application, it allows to create multiple instances and multiple configurations. For instance, the following architecture could be created for an high-speed device:

High-speed

```
|-- Configuration 0
    |-- Interface 0 (Vendor 0)
|-- Configuration 1
    |-- Interface 0 (Vendor 0)
    |-- Interface 1 (Vendor 1)
```

In that example, there are two instances of Vendor class: 'Vendor 0' and 'Vendor 1', and two possible configurations for the device: 'Configuration 0' and 'Configuration 1'. 'Configuration 1' is composed of two interfaces. Each class instance has an association with one of the interfaces. If 'Configuration 1' is activated by the host, it allows the host to access two different functionalities offered by the device.

G-1-4 USBD_Vendor_IsConn()

Get the vendor class connection state.

FILES

usbd_vendor.c

PROTOTYPE

```
CPU_BOOLEAN USBD_Vendor_IsConn (CPU_INT08U class_nbr);
```

ARGUMENTS

class_nbr Class instance number.

RETURNED VALUE

DEF_YES, if Vendor class is connected.

DEF_NO, otherwise.

CALLERS

Application.

NOTES / WARNINGS

`USB_D_Vendor_IsConn()` is typically used to verify that the device is in 'configured' state and that the vendor class instance is ready for communication. The following code illustrates a typical example:

```
CPU_BOOLEAN conn;

conn = USB_D_Vendor_IsConn(class_nbr);
while (conn != DEF_YES) {
    OSTimeDlyHMSM(0, 0, 0, 250);

    conn = USB_D_Vendor_IsConn(class_nbr);
}
```

Once the connected status is `DEF_YES`, the communication using the Bulk endpoints can start.

G-1-5 USBD_Vendor_Rd()

Receive data from host through Bulk OUT endpoint. This function is blocking.

FILES

usbd_vendor.c

PROTOTYPE

```
CPU_INT32U  USBD_Vendor_Rd (CPU_INT08U  class_nbr,  
                           void          *p_buf,  
                           CPU_INT32U  buf_len,  
                           CPU_INT16U  timeout,  
                           USBD_ERR    *p_err);
```

ARGUMENTS

class_nbr Class instance number.

p_buf Pointer to receive buffer.

buf_len Receive buffer length in octets.

timeout Timeout in milliseconds.

p_err Pointer to variable that will receive the return error code from this function.

```
USB_D_ERR_NONE  
USB_D_ERR_NULL_PTR  
USB_D_ERR_INVALID_ARG  
USB_D_ERR_INVALID_CLASS_STATE  
USB_D_ERR_DEV_INVALID_NBR  
USB_D_ERR_EP_INVALID_NBR  
USB_D_ERR_DEV_INVALID_STATE  
USB_D_ERR_EP_INVALID_TYPE
```

RETURNED VALUE

Number of octets received, if NO error(s).

0, otherwise.

CALLERS

Application.

NOTES / WARNINGS

None.

G-1-6 USBD_Vendor_Wr()

Send data to host through Bulk IN endpoint. This function is blocking.

FILES

usbd_vendor.c

PROTOTYPE

```
CPU_INT32U  USBD_Vendor_Wr (CPU_INT08U   class_nbr,  
                           void          *p_buf,  
                           CPU_INT32U   buf_len,  
                           CPU_INT16U   timeout,  
                           CPU_BOOLEAN   end,  
                           USBD_ERR     *p_err);
```

ARGUMENTS

- class_nbr** Class instance number.
- p_buf** Pointer to transmit buffer.
- buf_len** Transmit buffer length in octets.
- timeout** Timeout in milliseconds.
- end** End-of-transfer flag.
- p_err** Pointer to variable that will receive the return error code from this function.

```
USBD_ERR_NONE  
USBD_ERR_NULL_PTR  
USBD_ERR_INVALID_ARG  
USBD_ERR_INVALID_CLASS_STATE  
USBD_ERR_DEV_INVALID_NBR  
USBD_ERR_EP_INVALID_NBR  
USBD_ERR_DEV_INVALID_STATE  
USBD_ERR_EP_INVALID_TYPE
```

RETURNED VALUE

Number of octets sent, if NO error(s).

0, otherwise.

CALLERS

Application.

NOTES / WARNINGS

If end-of-transfer flag is set and transfer length is multiple of maximum packet size, a zero-length packet is transferred to indicate the end of transfer to the host.

G-1-7 USBD_Vendor_RdAsync()

Receive data from host through Bulk OUT endpoint. This function is non-blocking. It returns immediately after transfer preparation. Upon transfer completion, a callback provided by the application will be called to finalize the transfer.

FILES

usbd_vendor.c

PROTOTYPE

```
void USBD_Vendor_RdAsync (CPU_INT08U      class_nbr,
                          void            *p_buf,
                          CPU_INT32U     buf_len,
                          USBD_VENDOR_ASYNC_FNCT async_fnct,
                          void            *p_async_arg,
                          USBD_ERR       *p_err);
```

ARGUMENTS

class_nbr Class instance number.

p_buf Pointer to receive buffer.

buf_len Receive buffer length in octets.

async_fnct Receive callback.

p_async_arg Additional argument provided by application for receive callback.

p_err Pointer to variable that will receive the return error code from this function.

```
USB_D_ERR_NONE
USB_D_ERR_NULL_PTR
USB_D_ERR_INVALID_ARG
USB_D_ERR_INVALID_CLASS_STATE
USB_D_ERR_DEV_INVALID_NBR
USB_D_ERR_EP_INVALID_NBR
```

USBD_ERR_DEV_INVALID_STATE
USBD_ERR_EP_INVALID_TYPE
USBD_ERR_EP_INVALID_STATE

RETURNED VALUE

None.

CALLERS

Application.

NOTES / WARNINGS

None.

G-1-8 USBD_Vendor_WrAsync()

Send data to host through Bulk IN endpoint. This function is non-blocking. It returns immediately after transfer preparation. Upon transfer completion, a callback provided by the application will be called to finalize the transfer.

FILES

usbd_vendor.c

PROTOTYPE

```
void USBD_Vendor_WrAsync (CPU_INT08U          class_nbr,
                          void                *p_buf,
                          CPU_INT32U         buf_len,
                          USBD_VENDOR_ASYNC_FNCT async_fnct,
                          void                *p_async_arg,
                          CPU_BOOLEAN        end,
                          USBD_ERR          *p_err);
```

ARGUMENTS

class_nbr Class instance number.

p_buf Pointer to transmit buffer.

buf_len Transmit buffer length in octets.

async_fnct Transmit callback.

p_async_arg Additional argument provided by application for transmit callback.

end End-of-transfer flag.

p_err Pointer to variable that will receive the return error code from this function.

```
USB_D_ERR_NONE
USB_D_ERR_NULL_PTR
USB_D_ERR_INVALID_ARG
USB_D_ERR_INVALID_CLASS_STATE
```

USBD_ERR_DEV_INVALID_NBR
USBD_ERR_EP_INVALID_NBR
USBD_ERR_DEV_INVALID_STATE
USBD_ERR_EP_INVALID_TYPE
USBD_ERR_EP_INVALID_STATE

RETURNED VALUE

Number of octets sent, if NO error(s).

0, otherwise.

CALLERS

Application.

NOTES / WARNINGS

If end-of-transfer flag is set and transfer length is multiple of maximum packet size, a zero-length packet is transferred to indicate the end of transfer to the host.

G-1-9 USBD_Vendor_IntrRd()

Receive data from host through Interrupt OUT endpoint. This function is blocking.

FILES

usbd_vendor.c

PROTOTYPE

```
CPU_INT32U  USBD_Vendor_IntrRd (CPU_INT08U  class_nbr,  
                                void          *p_buf,  
                                CPU_INT32U  buf_len,  
                                CPU_INT16U  timeout,  
                                USBD_ERR    *p_err);
```

ARGUMENTS

class_nbr Class instance number.

p_buf Pointer to receive buffer.

buf_len Receive buffer length in octets.

timeout Timeout in milliseconds.

p_err Pointer to variable that will receive the return error code from this function.

```
USB_D_ERR_NONE  
USB_D_ERR_NULL_PTR  
USB_D_ERR_INVALID_ARG  
USB_D_ERR_INVALID_CLASS_STATE  
USB_D_ERR_DEV_INVALID_NBR  
USB_D_ERR_EP_INVALID_NBR  
USB_D_ERR_DEV_INVALID_STATE  
USB_D_ERR_EP_INVALID_TYPE
```

RETURNED VALUE

Number of octets received, if NO error(s).

0, otherwise.

CALLERS

Application.

NOTES / WARNINGS

None.

G-1-10 USBD_Vendor_IntrWr()

Send data to host through Interrupt IN endpoint. This function is blocking.

FILES

usbd_vendor.c

PROTOTYPE

```
CPU_INT32U  USBD_Vendor_IntrWr (CPU_INT08U  class_nbr,  
                                void          *p_buf,  
                                CPU_INT32U  buf_len,  
                                CPU_INT16U  timeout,  
                                CPU_BOOLEAN  end,  
                                USBD_ERR    *p_err);
```

ARGUMENTS

- class_nbr** Class instance number.
- p_buf** Pointer to transmit buffer.
- buf_len** Transmit buffer length in octets.
- timeout** Timeout in milliseconds.
- end** End-of-transfer flag.
- p_err** Pointer to variable that will receive the return error code from this function.

```
USBD_ERR_NONE  
USBD_ERR_NULL_PTR  
USBD_ERR_INVALID_ARG  
USBD_ERR_INVALID_CLASS_STATE  
USBD_ERR_DEV_INVALID_NBR  
USBD_ERR_EP_INVALID_NBR  
USBD_ERR_DEV_INVALID_STATE  
USBD_ERR_EP_INVALID_TYPE
```

RETURNED VALUE

Number of octets sent, if NO error(s).

0, otherwise.

CALLERS

Application.

NOTES / WARNINGS

If end-of-transfer flag is set and transfer length is multiple of maximum packet size, a zero-length packet is transferred to indicate the end of transfer to the host.

G-1-11 USBD_Vendor_IntrRdAsync()

Receive data from host through Interrupt OUT endpoint. This function is non-blocking. It returns immediately after transfer preparation. Upon transfer completion, a callback provided by the application will be called to finalize the transfer.

FILES

usbd_vendor.c

PROTOTYPE

```
void USBD_Vendor_IntrRdAsync (CPU_INT08U      class_nbr,
                             void            *p_buf,
                             CPU_INT32U     buf_len,
                             USBD_VENDOR_ASYNC_FNCT async_funct,
                             void          *p_async_arg,
                             USBD_ERR      *p_err);
```

ARGUMENTS

class_nbr Class instance number.

p_buf Pointer to receive buffer.

buf_len Receive buffer length in octets.

async_funct Receive callback.

p_async_arg Additional argument provided by application for receive callback.

p_err Pointer to variable that will receive the return error code from this function.

```
USB_D_ERR_NONE
USB_D_ERR_NULL_PTR
USB_D_ERR_INVALID_ARG
USB_D_ERR_INVALID_CLASS_STATE
USB_D_ERR_DEV_INVALID_NBR
USB_D_ERR_EP_INVALID_NBR
```

USBD_ERR_DEV_INVALID_STATE
USBD_ERR_EP_INVALID_TYPE
USBD_ERR_EP_INVALID_STATE

RETURNED VALUE

None.

CALLERS

Application.

NOTES / WARNINGS

None.

G-1-12 USBD_Vendor_IntrWrAsync()

Send data to host through Interrupt IN endpoint. This function is non-blocking. It returns immediately after transfer preparation. Upon transfer completion, a callback provided by the application will be called to finalize the transfer.

FILES

usbd_vendor.c

PROTOTYPE

```
void USBD_Vendor_IntrWrAsync (CPU_INT08U      class_nbr,
                             void            *p_buf,
                             CPU_INT32U      buf_len,
                             USBD_VENDOR_ASYNC_FNCT async_funct,
                             void            *p_async_arg,
                             CPU_BOOLEAN      end,
                             USBD_ERR        *p_err);
```

ARGUMENTS

class_nbr Class instance number.

p_buf Pointer to transmit buffer.

buf_len Transmit buffer length in octets.

async_funct Transmit callback.

p_async_arg Additional argument provided by application for transmit callback.

end End-of-transfer flag.

p_err Pointer to variable that will receive the return error code from this function.

```
USB_D_ERR_NONE
USB_D_ERR_NULL_PTR
USB_D_ERR_INVALID_ARG
USB_D_ERR_INVALID_CLASS_STATE
```

USBD_ERR_DEV_INVALID_NBR
USBD_ERR_EP_INVALID_NBR
USBD_ERR_DEV_INVALID_STATE
USBD_ERR_EP_INVALID_TYPE
USBD_ERR_EP_INVALID_STATE

RETURNED VALUE

Number of octets sent, if NO error(s).

0, otherwise.

CALLERS

Application.

NOTES / WARNINGS

If end-of-transfer flag is set and transfer length is multiple of maximum packet size, a zero-length packet is transferred to indicate the end of transfer to the host.

G-2 USBDEV_API FUNCTIONS

USBDev_API is a library implemented under Windows operating system. Functions return values and parameters use Windows data types such as **DWORD**, **HANDLE**, **ULONG**. Refer to MSDN online documentation for more details about Windows data types ([http://msdn.microsoft.com/en-us/library/aa383751\(v=VS.85\).aspx](http://msdn.microsoft.com/en-us/library/aa383751(v=VS.85).aspx)).

G-2-1 USBDev_GetNbrDev()

Get number of devices belonging to the specified GUID.

FILES

usbdev_api.c

PROTOTYPE

```
DWORD USBDev_GetNbrDev (const GUID guid_dev_if,  
                        DWORD *p_err);
```

ARGUMENTS

guid_dev_if Device interface class GUID.

p_err Pointer to variable that will receive the return error code from this function.

ERROR_SUCCESS

RETURNED VALUE

Number of devices for the provided GUID, if NO error(s).

0, otherwise.

CALLERS

Application.

NOTES / WARNINGS

The function `USBDev_GetNbrDev()` uses the concept of device information set. A device information set consists of device information elements for all the devices that belong to some device setup class or device interface class. The GUID passed to `USBDev_GetNbrDev()` function is a device interface class. Internally by using some control options the function retrieves the device information set which represents a list of all devices present in the system and registered under the specified GUID. More details about the device information set can be found at [http://msdn.microsoft.com/en-us/library/ff541247\(vs.85\).aspx](http://msdn.microsoft.com/en-us/library/ff541247(vs.85).aspx).

G-2-2 USBDev_Open()

Open a device by retrieving a general device handle.

FILES

usbdev_api.c

PROTOTYPE

```
HANDLE USBDev_Open (const GUID    guid_dev_if,  
                    DWORD    dev_nbr,  
                    DWORD    *p_err);
```

ARGUMENTS

guid_dev_if Device interface class GUID.

dev_nbr Device number.

p_err Pointer to variable that will receive the return error code from this function:

```
ERROR_SUCCESS  
ERROR_INVALID_PARAMETER  
ERROR_NOT_ENOUGH_MEMORY  
ERROR_BAD_DEVICE
```

RETURNED VALUE

Handle to device, if NO error(s).

INVALID_HANDLE_VALUE, otherwise.

CALLERS

Application.

NOTES / WARNINGS

None.

G-2-3 USBDev_Close()

Close a device by freeing any allocated resources and by releasing any created handles.

FILES

usbdev_api.c

PROTOTYPE

```
void USBDev_Close (HANDLE dev,  
                  DWORD *p_err);
```

ARGUMENTS

dev General handle to device.

p_err Pointer to variable that will receive the return error code from this function:

ERROR_SUCCESS
 ERROR_INVALID_HANDLE

RETURNED VALUE

None.

CALLERS

Application.

NOTES / WARNINGS

USBDev_Close() closes any remaining open pipes. The open pipes are usually closed from the application by calling the function USBDev_PipeClose().

G-2-4 USBDev_GetNbrAltSetting()

Get number of alternate settings for the specified interface.

FILES

usbdev_api.c

PROTOTYPE

```
UCHAR USBDev_GetNbrAltSetting (HANDLE dev,  
                                UCHAR if_nbr,  
                                DWORD *p_err);
```

ARGUMENTS

dev General handle to device.

if_nbr Interface number.

p_err Pointer to variable that will receive the return error code from this function:

```
ERROR_SUCCESS  
ERROR_INVALID_HANDLE  
ERROR_INVALID_PARAMETER
```

RETURNED VALUE

Number of alternate setting, if NO error(s).

0, otherwise.

CALLERS

Application.

NOTES / WARNINGS

An interface may include alternate settings that allow the endpoints and/or their characteristics to be varied after the device has been configured. The default setting for an interface is always alternate setting zero. Alternate settings allow a portion of the device configuration to be varied while other interfaces remain in operation.

The number of alternate settings gotten can be used to open a pipe associated with a certain alternate interface.

G-2-5 USBDev_GetNbrAssociatedIF()

Get number of associated interfaces with the default interface. That is all the interfaces besides the default interface managed by WinUSB.sys and registered under the same GUID.

FILES

usbdev_api.c

PROTOTYPE

```
UCHAR USBDev_GetNbrAssociatedIF (HANDLE dev,  
                                DWORD *p_err);
```

ARGUMENTS

dev General handle to device.

p_err Pointer to variable that will receive the return error code from this function:

```
ERROR_SUCCESS  
ERROR_INVALID_HANDLE
```

RETURNED VALUE

Number of associated interfaces, if NO error(s).

0, otherwise.

CALLERS

Application.

NOTES / WARNINGS

Let's assume that a device has three interfaces managed by WinUSB.sys driver and belonging to the same GUID: Interface #0, #1 and #2. Interface #0 is the default interface. Interfaces #1 and #2 are the associated interfaces. In that example calling USBDev_GetNbrAssociatedIF() will return 2 associated interfaces.

G-2-6 USBDev_SetAltSetting()

Set the alternate setting of an interface.

FILES

usbdev_api.c

PROTOTYPE

```
void USBDev_SetAltSetting (HANDLE dev,
                           UCHAR  if_nbr,
                           UCHAR  alt_set,
                           DWORD  *p_err);
```

ARGUMENTS

dev General handle to device.

if_nbr Interface number.

alt_set Alternate setting number.

p_err Pointer to variable that will receive the return error code from this function:

```
ERROR_SUCCESS
ERROR_INVALID_HANDLE
ERROR_INVALID_PARAMETER
```

RETURNED VALUE

None.

CALLERS

Application.

NOTES / WARNINGS

This function sets alternate setting number for WinUSB internal use. It does *not* send a **SET_INTERFACE** request to the device. To send **SET_INTERFACE** request to the device, the function `USBDev_CtrlReq()` must be used.

G-2-7 USBDev_GetCurAltSetting()

Get the current alternate setting for the specified interface.

FILES

usbdev_api.c

PROTOTYPE

```
UCHAR USBDev_GetCurAltSetting (HANDLE dev,  
                                UCHAR if_nbr,  
                                DWORD *p_err);
```

ARGUMENTS

dev General handle to device.

if_nbr Interface number.

p_err Pointer to variable that will receive the return error code from this function:

```
ERROR_SUCCESS  
ERROR_INVALID_HANDLE  
ERROR_INVALID_PARAMETER
```

RETURNED VALUE

Current alternate setting number, if NO error(s).

0, otherwise.

CALLERS

Application.

NOTES / WARNINGS

This function gets the current alternate setting number used internally by WinUSB and set by the function `USBDev_SetAltSetting()`. It does NOT send a `GET_INTERFACE` request to the device. To send `GET_INTERFACE` request to the device, the function `USBDev_CtrlReq()` must be used.

G-2-8 USBDev_IsHighSpeed()

Specify if the device attached to PC is high speed or not.

FILES

usbdev_api.c

PROTOTYPE

```
BOOL USBDev_IsHighSpeed (HANDLE dev,  
                          DWORD *p_err);
```

ARGUMENTS

dev General handle to device.

p_err Pointer to variable that will receive the return error code from this function:

```
ERROR_SUCCESS  
ERROR_INVALID_HANDLE  
ERROR_INVALID_PARAMETER
```

RETURNED VALUE

TRUE, if device is high-speed.

FALSE, otherwise.

CALLERS

Application.

NOTES / WARNINGS

None.

G-2-9 USBDev_BulkIn_Open()

Open a Bulk IN pipe.

FILES

usbdev_api.c

PROTOTYPE

```
HANDLE USBDev_BulkIn_Open (HANDLE dev,
                           UCHAR  if_nbr,
                           UCHAR  alt_set,
                           DWORD  *p_err);
```

ARGUMENTS

dev General handle to device.

if_nbr Interface number.

alt_set Alternate setting number for specified interface.

p_err Pointer to variable that will receive the return error code from this function:

```
ERROR_SUCCESS
ERROR_INVALID_HANDLE
ERROR_NO_MORE_ITEMS
```

RETURNED VALUE

Handle to Bulk IN pipe, if NO error(s).
INVALID_HANDLE_VALUE, otherwise.

CALLERS

Application.

NOTES / WARNINGS

None.

G-2-10 USBDev_BulkOut_Open()

Open a Bulk OUT pipe.

FILES

usbdev_api.c

PROTOTYPE

```
HANDLE USBDev_BulkOut_Open (HANDLE dev,
                             UCHAR  if_nbr,
                             UCHAR  alt_set,
                             DWORD  *p_err);
```

ARGUMENTS

dev General handle to device.

if_nbr Interface number.

alt_set Alternate setting number for specified interface.

p_err Pointer to variable that will receive the return error code from this function:

```
ERROR_SUCCESS
ERROR_INVALID_HANDLE
ERROR_NO_MORE_ITEMS
```

RETURNED VALUE

Handle to Bulk OUT pipe, if NO error(s).
INVALID_HANDLE_VALUE, otherwise.

CALLERS

Application.

NOTES / WARNINGS

None.

G-2-11 USBDev_IntrIn_Open()

Open a Interrupt IN pipe.

FILES

usbdev_api.c

PROTOTYPE

```
HANDLE USBDev_IntrIn_Open (HANDLE dev,
                           UCHAR  if_nbr,
                           UCHAR  alt_set,
                           DWORD  *p_err);
```

ARGUMENTS

dev General handle to device.

if_nbr Interface number.

alt_set Alternate setting number for specified interface.

p_err Pointer to variable that will receive the return error code from this function:

```
ERROR_SUCCESS
ERROR_INVALID_HANDLE
ERROR_NO_MORE_ITEMS
```

RETURNED VALUE

Handle to Interrupt IN pipe, if NO error(s).

INVALID_HANDLE_VALUE, otherwise.

CALLERS

Application.

NOTES / WARNINGS

None.

G-2-12 USBDev_IntrOut_Open()

Open a Interrupt OUT pipe.

FILES

usbdev_api.c

PROTOTYPE

```
HANDLE USBDev_IntrOut_Open (HANDLE dev,
                             UCHAR if_nbr,
                             UCHAR alt_set,
                             DWORD *p_err);
```

ARGUMENTS

dev General handle to device.

if_nbr Interface number.

alt_set Alternate setting number for specified interface.

p_err Pointer to variable that will receive the return error code from this function:

```
ERROR_SUCCESS
ERROR_INVALID_HANDLE
ERROR_NO_MORE_ITEMS
```

RETURNED VALUE

Handle to Interrupt OUT pipe, if NO error(s).

INVALID_HANDLE_VALUE, otherwise.

CALLERS

Application.

NOTES / WARNINGS

None.

G-2-13 USBDev_PipeGetAddr()

Get pipe address.

FILES

usbdev_api.c

PROTOTYPE

```
UCHAR USBDev_PipeGetAddr (HANDLE pipe,  
                          DWORD *p_err);
```

ARGUMENTS

pipe Pipe handle.

p_err Pointer to variable that will receive the return error code from this function:

```
ERROR_SUCCESS  
ERROR_INVALID_HANDLE
```

RETURNED VALUE

Pipe address, if NO error(s).

0, otherwise.

CALLERS

Application.

NOTES / WARNINGS

None.

G-2-14 USBDev_PipeClose()

Close a pipe.

FILES

usbdev_api.c

PROTOTYPE

```
void USBDev_PipeClose (HANDLE pipe,  
                      DWORD *p_err);
```

ARGUMENTS

pipe Pipe handle.

p_err Pointer to variable that will receive the return error code from this function:

ERROR_SUCCESS
ERROR_INVALID_HANDLE

RETURNED VALUE

None

CALLERS

Application.

NOTES / WARNINGS

None.

G-2-15 USBDev_PipeStall()

Stall a pipe or clear the stall condition of a pipe.

FILES

usbdev_api.c

PROTOTYPE

```
void USBDev_PipeStall (HANDLE pipe,
                      BOOL stall,
                      DWORD *p_err);
```

ARGUMENTS

pipe Pipe handle.

stall Indicate which action to do:

TRUE Stall pipe.

FALSE Clear stall condition of the pipe.

p_err Pointer to variable that will receive the return error code from this function:

ERROR_SUCCESS

ERROR_INVALID_HANDLE

ERROR_NOT_ENOUGH_MEMORY

RETURNED VALUE

None.

CALLERS

Application.

NOTES / WARNINGS

The **SET_FEATURE** standard request is sent to the device to stall the pipe. The **CLEAR_FEATURE** standard request is sent to the device to clear the stall condition of the pipe.

G-2-16 USBDev_PipeAbort()

Aborts all of the pending transfers for a pipe.

FILES

usbdev_api.c

PROTOTYPE

```
void USBDev_PipeAbort (HANDLE pipe,  
                      DWORD *p_err);
```

ARGUMENTS

pipe Pipe handle.

p_err Pointer to variable that will receive the return error code from this function:

ERROR_SUCCESS
 ERROR_INVALID_HANDLE

RETURNED VALUE

None.

CALLERS

Application.

NOTES / WARNINGS

None.

G-2-17 USBDev_CtrlReq()

Send control data over the default control endpoint.

FILES

usbdev_api.c

PROTOTYPE

```
ULONG USBDev_CtrlReq (HANDLE dev,
                      UCHAR bm_req_type,
                      UCHAR b_request,
                      USHORT w_value,
                      USHORT w_index,
                      UCHAR *p_buf,
                      USHORT buf_len,
                      DWORD *p_err);
```

ARGUMENTS

dev General handle to device

bm_req_type Variable representing **bmRequestType** of setup packet. **bmRequestType** is a bitmap with the following characteristics:

D7 Data transfer direction:

'0': USB_DIR_HOST_TO_DEVICE

'1': USB_DIR_DEVICE_TO_HOST

D6...5 Request type:

'00': USB_REQUEST_TYPE_STD (standard)

'01': USB_REQUEST_TYPE_CLASS

'10': USB_REQUEST_TYPE_VENDOR

D4...0 Recipient:

'0000': USB_RECIPIENT_DEV (device)
 '0001': USB_RECIPIENT_IF (interface)
 '0010': USB_RECIPIENT_ENDPOINT

bm_req_type Argument is a OR'ed of D7, D6...5 and D4...0 values.

b_request Variable representing **bRequest** of setup packet. Possible values are:

GET_STATUS	Returns status for the specified recipient.
CLEAR_FEATURE	Clear or disable a specific feature.
SET_FEATURE	Set or enable a specific feature.
SET_ADDRESS	Set the device address for all future device accesses.
GET_DESCRIPTOR	Return the specified descriptor if the descriptor exists.
SET_DESCRIPTOR	Update existing descriptors or new descriptors may be added.
GET_CONFIGURATION	Return the current device configuration value.
SET_CONFIGURATION	Set the device configuration.
GET_INTERFACE	Return the selected alternate setting for the specified interface.
SET_INTERFACE	Select an alternate setting for the specified interface.
SYNCH_FRAME	Set and then report an endpoint's synchronization frame.

w_value Variable representing **wValue** of setup packet.

w_index Variable representing **wIndex** of setup packet.

p_buf Pointer to transmit or receive buffer for data phase of control transfer.

buf_len Length of transmit or receive buffer.

p_err Pointer to variable that will receive the return error code from this function:

```
ERROR_SUCCESS
ERROR_INVALID_HANDLE
ERROR_NOT_ENOUGH_MEMORY
ERROR_GEN_FAILURE
```

RETURNED VALUE

None

CALLERS

Application.

NOTES / WARNINGS

The value of **w_value** and **w_index** arguments vary according to the specific request defined by **b_request** argument.

The following code shows an example using **USBDev_CtrlReq()** to send the **SET_INTERFACE** request:

```
DWORD err;
/* Select alternate setting #1 for default interface. */
USBDev_CtrlReq ( dev_handle,
                (USB_DIR_HOST_TO_DEVICE | USB_REQUEST_TYPE_STD | USB_RECIPIENT_IF),
                SET_INTERFACE,
                1, /* Alternate setting #1. */
                0, /* Interface #0 inside active configuration. */
                0, /* No data phase. */
                &err);
if (err != ERROR_SUCCESS) {
    printf("[ERROR #%d] SET_INTERFACE(1) request failed.\n", err);
}
```

More details about USB device requests can be found in “Universal Serial Bus Specification, Revision 2.0, April 27, 2000”, section 9.3.

G-2-18 USBDev_PipeWr()

Write data to device over the specified pipe.

FILES

usbdev_api.c

PROTOTYPE

```
DWORD USBDev_PipeWr (HANDLE pipe,
                    UCHAR *p_buf,
                    DWORD buf_len,
                    DWORD timeout,
                    DWORD *p_err);
```

ARGUMENTS

- pipe** Pipe handle.
- p_buf** Pointer to transmit buffer.
- buf_len** Transmit buffer length.
- timeout** Timeout in milliseconds. A value of 0 indicates a wait forever.
- p_err** Pointer to variable that will receive the return error code from this function:

```
ERROR_SUCCESS
ERROR_INVALID_HANDLE
ERROR_INVALID_USER_BUFFER
ERROR_BAD_PIPE
ERROR_INVALID_PARAMETER
ERROR_NOT_ENOUGH_MEMORY
ERROR_SEM_TIMEOUT
```

RETURNED VALUE

Number of bytes written, if NO error(s).

0, otherwise.

CALLERS

Application.

NOTES / WARNINGS

None.

G-2-19 USBDev_PipeRd()

Read data from device over the specified pipe.

FILES

usbdev_api.c

PROTOTYPE

```
DWORD USBDev_PipeRd (HANDLE pipe,  
                    UCHAR *p_buf,  
                    DWORD buf_len,  
                    DWORD timeout,  
                    DWORD *p_err);
```

ARGUMENTS

- pipe** Pipe handle.
- p_buf** Pointer to receive buffer.
- buf_len** Receive buffer length.
- timeout** Timeout in milliseconds. A value of 0 indicates a wait forever.
- p_err** Pointer to variable that will receive the return error code from this function:

```
ERROR_SUCCESS  
ERROR_INVALID_HANDLE  
ERROR_INVALID_USER_BUFFER  
ERROR_BAD_PIPE  
ERROR_INVALID_PARAMETER  
ERROR_NOT_ENOUGH_MEMORY  
ERROR_SEM_TIMEOUT7
```

RETURNED VALUE

Number of bytes received, if NO error(s).

0, otherwise.

CALLERS

Application.

NOTES / WARNINGS

None.

G-2-20 USBDev_PipeRdAsync()

Read data from device over the specified pipe. This function returns immediately if data is not present. The data will be retrieved later.

FILES

usbdev_api.c

PROTOTYPE

```
void USBDev_PipeRdAsync (HANDLE          pipe,
                        UCHAR            *p_buf,
                        DWORD            buf_len,
                        USBDEV_PIPE_RD_CALLBACK callback,
                        void             *p_callback_arg,
                        DWORD            *p_err);
```

ARGUMENTS

pipe Pipe handle.

p_buf Pointer to receive buffer.

buf_len Receive buffer length.

callback Pointer to application callback called by Asynchronous thread upon completion.

p_callback_arg Pointer to argument which can carry private information passed by application. This argument is used when the callback is called.

p_err Pointer to variable that will receive the return error code from this function:

```
ERROR_SUCCESS
ERROR_INVALID_HANDLE
ERROR_INVALID_USER_BUFFER
ERROR_BAD_PIPE
ERROR_NOT_ENOUGH_MEMORY
ERROR_SEM_TIMEOUT
```

RETURNED VALUE

None.

CALLERS

Application.

NOTES / WARNINGS

When a IN pipe is open with one of the open functions `USBDev_XXXXIn_Open()`, a thread is automatically created. This thread is in charge of informing the application about a completed asynchronous IN transfer. Upon completion of an asynchronous transfer, the thread is waken up and calls the application callback provided to `USBDev_API` library using the `callback` argument.

`USBDev_API` library allows to queue several asynchronous IN transfers for the same pipe.

Appendix

H

Error Codes

This appendix provides a brief explanation of μ C/USB-Device error codes defined in `usbd_core.h`. Any error codes not listed here may be searched in `usbd_core.h` for both their numerical value and usage.

Each error has a numerical value. The error codes are grouped. The definition of the groups are:

Error code group	Numbering series
GENERIC	0
DEVICE	100
CONFIGURATION	200
INTERFACE	300
ENDPOINT	400
OS LAYER	500

H-1 GENERIC ERROR CODES

0	USBD_ERR_NONE	No error.
1	USBD_ERR_SHORT_XFER	Short transfer detected.
2	USBD_ERR_FAIL	Hardware error occurred.
3	USBD_ERR_RX	Generic receive error. A problem has occurred during read transfer preparation or after data has been received.
4	USBD_ERR_TX	Generic transmit error. A problem has occurred during write transfer preparation. No data transmitted or data transmitted with a certain problem.
5	USBD_ERR_ALLOC	Object/memory allocation failed.
6	USBD_ERR_NULL_PTR	Pointer argument(s) passed NULL pointer(s).
7	USBD_ERR_INVALID_ARG	Invalid argument(s).
8	USBD_ERR_INVALID_CLASS_STATE	Invalid class state.

H-2 DEVICE ERROR CODES

100	USBD_ERR_DEV_ALLOC	Device allocation failed.
101	USBD_ERR_DEV_INVALID_NBR	Invalid device number.
102	USBD_ERR_DEV_INVALID_STATE	Invalid device state.
103	USBD_ERR_DEV_INVALID_SPD	Invalid device speed.

H-3 CONFIGURATION ERROR CODES

200	USBD_ERR_CFG_ALLOC	Configuration allocation failed.
201	USBD_ERR_CFG_INVALID_NBR	Invalid configuration number.
202	USBD_ERR_CFG_INVALID_MAX_PWR	Invalid maximum power.
203	USBD_ERR_CFG_SET_FAIL	Device driver set configuration failed.

H-4 INTERFACE ERROR CODES

300	USBD_ERR_IF_ALLOC	Interface allocation failed.
301	USBD_ERR_IF_INVALID_NBR	Invalid interface number.
302	USBD_ERR_IF_ALT_ALLOC	Alternate interface setting allocation failed.
303	USBD_ERR_IF_ALT_INVALID_NBR	Invalid interface alternate setting number.
304	USBD_ERR_IF_GRP_ALLOC	Interface group allocation failed.
305	USBD_ERR_IF_GRP_NBR_IN_USE	Interface group number already in use.

H-5 ENDPOINT ERROR CODES

400	USBD_ERR_EP_ALLOC	Endpoint allocation failed.
401	USBD_ERR_EP_INVALID_ADDR	Invalid endpoint address.
402	USBD_ERR_EP_INVALID_STATE	Invalid endpoint state.
403	USBD_ERR_EP_INVALID_TYPE	Invalid endpoint type.
404	USBD_ERR_EP_NONE_AVAIL	Physical endpoint NOT available.
405	USBD_ERR_EP_ABORT	Device driver abort transfer for an endpoint failed.
406	USBD_ERR_EP_STALL	Device driver stall endpoint failed.
407	USBD_ERR_EP_IO_PENDING	I/O operation pending on endpoint.

H-6 OS LAYER ERROR CODES

500	USBD_ERR_OS_INIT_FAIL	OS layer initialization failed.
501	USBD_ERR_OS_SIGNAL_CREATE	OS signal NOT successfully created.
502	USBD_ERR_OS_FAIL	OS object Pend/Post failed.
503	USBD_ERR_OS_TIMEOUT	OS object timeout.
504	USBD_ERR_OS_ABORT	OS object abort.
505	USBD_ERR_OS_DEL	OS object delete.

Memory Footprint

μ C/USB-Device's memory footprint can be scaled to contain only the features required for your specific application. Refer to Chapter 5, "Configuration" on page 65 to better understand how to configure the stack and your application. This appendix will provide a reference to μ C/USB-Device's memory footprint for each associated device class offered by Micrium. Each class presents a table of device configuration values that represents the configuration used for the footprint calculation. All footprint values calculated in this appendix has been obtained with the environment configuration shown in Table I-1 and μ C/USB-Device general configuration shown in Table I-2.

Note that any Device Controller Driver offered by the μ C/USB-Device stack can allocate internal data structures from the heap. You can use memory functions from μ C/LIB, common standard library functions, macros and constants developed by Micrium, to determine the amount of heap that has been allocated for the Device Controller Driver. Refer to μ C/LIB documentation for more information.

Specification	Configuration
Architecture	ARM
Microcontroller	NXP LPC2468-EA
Compiler	IAR EWARM V6.21
Compiler Optimization	High for Size and Speed
OS	μ C/OS-III

Table I-1 **Memory Footprint Environment Configuration**

Device Configuration	Value
USBD_CFG_OPTIMIZE_SPD	DEF_DISABLED
USBD_CFG_MAX_NBR_DEV	1
USBD_CFG_MAX_NBR_CFG	1

Table I-2 Memory Footprint μ C/USB Device Configuration

I-0-1 COMMUNICATIONS DEVICE CLASS

The Communication Device Class (CDC) configuration is presented in Table I-3 and its associated memory footprint table is shown in Table I-4.

Configuration	Value
USBD_CFG_MAX_NBR_IF	2
USBD_CFG_MAX_NBR_IF_ALT	2
USBD_CFG_MAX_NBR_IF_GRP	1
USBD_CFG_MAX_NBR_EP_DESC	3
USBD_CFG_MAX_NBR_EP_OPEN	5
USBD_CDC_CFG_MAX_NBR_DEV	1
USBD_CDC_CFG_MAX_NBR_CFG	2
USBD_CDC_CFG_MAX_NBR_DATA_IF	1
USBD_ACM_SERIAL_CFG_MAX_NBR_DEV	1

Table I-3 CDC Configuration for Memory Footprint

Module	Code (kB)	Constant (kB)	Data (kB)
Device Core	20.62	-	0.47
Device RTOS Port	0.76	-	1.39
Device Controller Driver	6.74	0.21	Data allocated from heap.
CDC	2.55	-	0.07
ACM Subclass	2.20	-	0.04
Total:	32.87	0.21	1.97

Table I-4 CDC Memory Footprint

I-0-2 HUMAN INTERFACE DEVICE CLASS

The Human Interface Device (HID) Class configuration is presented in Table I-5 and its associated memory footprint table is shown in Table I-6. Note that there is an optional Interrupt OUT endpoint that you may add during HID initialization that has been omitted in the configuration below. Also note that the Data size shown for HID class does not take into account memory allocated for input report buffer(s), output report and feature report buffers from the heap. You can use memory functions from μ C/LIB to determine the amount of heap that has been allocated for these HID reports. Refer to μ C/LIB documentation for more information.

Configuration	Value
USBD_CFG_MAX_NBR_IF	1
USBD_CFG_MAX_NBR_IF_ALT	1
USBD_CFG_MAX_NBR_IF_GRP	0
USBD_CFG_MAX_NBR_EP_DESC	1
USBD_CFG_MAX_NBR_EP_OPEN	3
USBD_HID_CFG_MAX_NBR_DEV	1
USBD_HID_CFG_MAX_NBR_CFG	2
USBD_HID_CFG_MAX_NBR_REPORT_ID	16
USBD_HID_CFG_MAX_NBR_REPORT_PUSHPOP	0

Table I-5 HID Configuration for Memory Footprint

Module	Code (kB)	Constant (kB)	Data (kB)
Device Core	19.17	-	0.78
Device RTOS Port	0.76	-	1.31
Device Controller Driver	6.74	0.21	*Data allocated from heap.
HID	6.29	-	0.52 *Input, Output and/or Feature Report buffers allocated from heap. Refer to section I-0-2 "Human Interface Device Class" on page 533 for details.
HID RTOS Port	1.05	-	1.39
Total:	34.01	0.21	4.00

Table I-6 HID Memory Footprint

I-0-3 MASS STORAGE CLASS

The Mass Storage Class (MSC) configuration is presented in Table I-7 and its associated memory footprint table is shown in Table I-8.

Configuration	Value
USBD_CFG_MAX_NBR_IF	1
USBD_CFG_MAX_NBR_IF_ALT	1
USBD_CFG_MAX_NBR_IF_GRP	0
USBD_CFG_MAX_NBR_EP_DESC	2
USBD_CFG_MAX_NBR_EP_OPEN	4
USBD_MSC_CFG_MAX_NBR_DEV	1
USBD_MSC_CFG_MAX_NBR_CFG	2
USBD_MSC_CFG_MAX_LUN	1
USBD_MSC_CFG_DATA_LEN	2048

Table I-7 MSC Configuration for Memory Footprint

Module	Code (kB)	Constant (kB)	Data (kB)
Device Core	19.13	-	0.85
Device RTOS Port	0.76	-	1.35
Device Controller Driver	6.74	0.21	*Data allocated from heap.
MSC	7.57	0.03	2.55
MSC RTOS Port	0.68	-	1.27
RAMDisk Storage	0.36	-	*RAMDisk Storage layer allocates data sections to simulate a memory area from a media storage. This memory area size is configured in <code>app_cfg.h</code> .
Total:	35.24	0.24	6.02

Table I-8 **MSC Memory Footprint**

I-0-4 PERSONAL HEALTHCARE DEVICE CLASS

The Personal Healthcare Device Class (PHDC) configuration is presented in Table I-9 and its associated memory footprint table is shown in Table I-10. Note that there is an optional Interrupt IN endpoint that you may add during PHDC initialization that has been omitted in the configuration below. Also note that the memory footprint is taken for both QOS Based Scheduler enabled and disabled configurations. The memory footprint for the PHDC RTOS layer therefore reflects the differences when it is one configuration or the other.

Configuration	Value
USBD_CFG_OPTIMIZE_SPD	DEF_DISABLED
USBD_CFG_MAX_NBR_DEV	1
USBD_CFG_MAX_NBR_CFG	1
USBD_CFG_MAX_NBR_IF	1
USBD_CFG_MAX_NBR_IF_ALT	1
USBD_CFG_MAX_NBR_IF_GRP	0
USBD_CFG_MAX_NBR_EP_DESC	2
USBD_CFG_MAX_NBR_EP_OPEN	4
USBD_PHDC_CFG_MAX_NBR_DEV	1
USBD_PHDC_CFG_MAX_NBR_CFG	2
USBD_PHDC_CFG_DATA_OPAQUE_MAX_LEN	43
USBD_PHDC_OS_CFG_SCHED_EN	DEF_ENABLED/DEF_DISABLED

Table I-9 PHDC Configuration for Memory Footprint

Module	Code (kB)	Constant (kB)	Data (kB)
Device Core	19.82	-	0.85
Device RTOS Port	0.76	-	1.35
Device Controller Driver	6.74	0.21	Data allocated from heap.
PHDC	4.70	-	0.21
PHDC RTOS Port (QOS Based Scheduler Enabled)	1.56	-	1.62
PHDC RTOS Port (QOS Based Scheduler Disabled)	0.66	-	0.11
Total (QOS Based Scheduler Enabled/ Disabled):	33.58 / 32.68	0.21	4.03 / 2.52

Table I-10 PHDC Memory Footprint

I-0-5 VENDOR CLASS

The Vendor Class configuration is presented in Table I-11 and its associated memory footprint table is shown in Table I-12. Note that there is a pair of Interrupt IN/OUT endpoints that you may add during Vendor Class initialization that has been omitted in the configuration below.

Configuration	Value
USBD_CFG_MAX_NBR_IF	1
USBD_CFG_MAX_NBR_IF_ALT	1
USBD_CFG_MAX_NBR_IF_GRP	0
USBD_CFG_MAX_NBR_EP_DESC	2
USBD_CFG_MAX_NBR_EP_OPEN	4
USBD_VENDOR_CFG_MAX_NBR_DEV	1
USBD_VENDOR_CFG_MAX_NBR_CFG	2

Table I-11 Vendor Class Configuration for Memory Footprint

Module	Code (kB)	Constant (kB)	Data (kB)
Device Core	18.18	-	0.85
Device RTOS Port	0.76	-	1.35
Device Controller Driver	6.74	0.21	Data allocated from heap.
Vendor	1.05	-	0.09
Total:	26.73	0.21	2.29

Table I-12 Vendor Class Memory Footprint

Index

A

abstraction layer	57
ACM requests	122
ACM subclass	121
initialization API	123
requests and notifications	127
serial emulation	123
app.c	32
app_<module>.c	33
app_<module>.h	33
app_cfg.h	33, 38, 55, 130, 221
APP_CFG_FS_BUF_CNT	178
APP_CFG_FS_DEV_CNT	178
APP_CFG_FS_DEV_DRV_CNT	178
APP_CFG_FS_DIR_CNT	178
APP_CFG_FS_EN	178
APP_CFG_FS_FILE_CNT	178
APP_CFG_FS_IDE_EN	178
APP_CFG_FS_MAX_SEC_SIZE	178
APP_CFG_FS_MSC_EN	178
APP_CFG_FS_NBR_TEST	178
APP_CFG_FS_NOR_EN	178
APP_CFG_FS_RAM_EN	178
APP_CFG_FS_RAM_NBR_SEC	178
APP_CFG_FS_RAM_SEC_SIZE	178
APP_CFG_FS_SD_CARD_EN	178
APP_CFG_FS_SD_EN	178
APP_CFG_FS_VOL_CNT	178
APP_CFG_FS_WORKING_DIR_CNT	178
APP_CFG_RX_ASYNC_EN	222
APP_CFG_USBD_CDC_EN	130
APP_CFG_USBD_CDC_SERIAL_TASK_PRIO	130
APP_CFG_USBD_CDC_SERIAL_TASK_STK_SIZE	130
APP_CFG_USBD_CDC_SERIAL_TEST_EN	130
APP_CFG_USBD_EN	39, 177
APP_CFG_USBD_HID_EN	155
APP_CFG_USBD_HID_MOUSE_TASK_PRIO	155
APP_CFG_USBD_HID_READ_TASK_PRIO	155
APP_CFG_USBD_HID_TASK_STK_SIZE	155
APP_CFG_USBD_HID_TEST_MOUSE_EN	155
APP_CFG_USBD_HID_WRITE_TASK_PRIO	155
APP_CFG_USBD_MSC_EN	177

APP_CFG_USBD_VENDOR_ECHO_ASYNC_EN	221
APP_CFG_USBD_VENDOR_ECHO_ASYNC_TASK_PRIO ..	221
APP_CFG_USBD_VENDOR_ECHO_SYNC_EN	221
APP_CFG_USBD_VENDOR_ECHO_SYNC_TASK_PRIO ..	221
APP_CFG_USBD_VENDOR_EN	221
APP_CFG_USBD_VENDOR_TASK_STK_SIZE	221
APP_CFG_USBD_XXXX_EN	39
App_DevPathStr	156
app_hid_common.c	156
application	
configuration	38, 69
configuration constants	188
configuration file	38
modules relationship	55
preprocessor constants	177
APP_MAX_NBR_VENDOR_DEV	222
app_usbd.*	33
app_usbd.c	36
app_usbd_<class>.c	33
app_usbd_cdc.c	120, 129
App_USBD_CDC_Init()	43, 120
App_USBD_CDC_SerialLineCoding()	126
App_USBD_CDC_SerialLineCtrl()	126
App_USBD_HID_Callback	147
App_USBD_HID_Init()	43
App_USBD_HID_MouseTask()	157
App_USBD_HID_ReadTask()	158
App_USBD_HID_WriteTask()	158
App_USBD_Init()	36, 40–41
App_USBD_MSC_Init()	43
App_USBD_PHDC_Init()	43
app_usbd_vendor.c	220
App_USBD_Vendor_Init()	43
App_USBD_XXXX_Init()	42
app_vendor_echo.c	221–222
architecture	
block diagram	54
CDC	119
device driver	77
HID class	142
host and CDC	119
host and HID class	142
host and Vendor class	206
MS class	169
RTOS interactions	239

Index

aSignature187
asynchronous communication152, 212
asynchronous read and write153, 213
asynchronous receive91
asynchronous transmit95

B

bmLatencyReliability187
bNumTransfers187
board support88
bOpaqueData187
bOpaqueDataSize187
bQoSEncodingVersion187
BSP interface API88
bus topology15–16

C

callback
 interactions111
 requests mapping113
 structure111–112
CDC532
 architecture119
 configuration68, 120, 123
 configuration constants120
 demo132, 134
 device50, 117
 endpoints117
 functions354
 initialization120
 memory footprint532–533
 serial demo133
 subclasses118
CDC-ACM
 API128
 configuration68
 functions369
 initialization125
class instance99
 API functions174
 communication109
 communication, HID class150
 communication, PHDC192
 communication, Vendor class210
 configuration, HID class144
 configuration, MS class174
 configuration, PHDC189
 configuration, Vendor class208
 control structure108
 multiple99
 structures108
class state machine110
ClassReq()113
ClearCommFeature122
CLEAR_FEATURE113
complex composite high-speed USB device74
 configuration76
 structure75

composite high-speed USB device73
 configuration74
 structure73
configuration66
 CDC120, 123
 complex composite high-speed USB device76
 composite high-speed USB device74
 constants232
 constants, CDC120
 constants, HID class143
 constants, MS class173
 constants, PHDC188
 constants, Vendor class207
 device34, 85
 device application130, 155, 221
 device controller driver71
 driver35
 error codes528
 examples71
 functions253
 HID class68, 143
 interface66
 MS class69, 173
 PC and device applications154, 220
 PHDC69, 187, 191
 simple full-speed USB device72
 static stack65
 string67
 USB device66, 86
 USB device controller driver85
 Vendor class69, 207
Conn()113
constants232
 CDC120
 HID class143
 MS class173
 PHDC188
 Vendor class207
control transfer stages19
control.exe159
core events management241
core layer, porting242
core OS functions298
core OS port API242
core task243
CPU layer58
CPU support88

D

data characteristics184
data flow model17
debug
 configuration68, 232
 event pool234
 events234
 events management241
 format233
 processing events63
 sample output233
 task234, 243
 trace output232
 traces232

tracing macros	236
debug macros	234–235
demo application	154, 200, 203, 220
CDC	129
composite device	228
configuration constants	200
files	200
HID class	156, 158
MS class	176
PHDC	201–202
single device	227
Vendor class	224, 226
detect a specific HID device	156
device	
application configuration	130, 155, 221
communication	218
configuration	34, 85
controller driver configuration	71
driver configuration	35
error codes	528
functions	246
set address	97
states	24
structure and enumeration	22
synchronous receive	89
synchronous transmit	93
device driver	
API	78
architecture	77
BSP functions	350
callbacks functions	313
functions	324
interface API	78
model	78
Disconn()	113
E	
echo	224
endpoint	17
CDC	117
error codes	529
functions	261
HID class	136
information table	86–87
information table configuration	87
management layer	56
MS class	167
PHDC	185
QoS mapping	185
Vendor class	207
enumeration	25
EPDesc()	113
EPDescGetSize()	113
error codes	528
configuration	528
device	528
F	
full speed	21

G	
GetCommFeature	122
GET_DESCRIPTOR	113
GET_LINE_CODING	132
GetLineCoding	122, 127
GET_PROTOCOL	147
GET_REPORT	136, 141, 147, 158, 160
GUID	51, 228
device interface class	52
Micrijm class	52
H	
hardware abstraction layer	57
HID class	135
architecture	142
communication	150
communication API	150
configuration	68, 143
configuration constants	143
demo application	156, 158
endpoint	136
functions	388
initialization	146
initialization API	144
memory footprint	533
OS functions	402
OS layer API	161
porting	160
high speed	21
host	16
host application	179
I	
IFDesc()	113
IFDescGetSize()	113
IFReq()	113
INF file	46, 222–223
example	223
structure	48
installation	30
interface	
configuration	66
error codes	529
functions	255
interrupt handling	81
interrupt.exe	159
ISR handler	81
ISR vector	81–83
L	
low speed	21

Index

M

memory allocation	88
memory footprint	531
CDC	532–533
HID class	533
MS class	534
PHDC	535–536
Vendor class	537
metadata preamble	187, 192, 196
module	
dependency	29
libraries	55
relationship	55
mouse demo	156
Mouse Report Descriptor Example	148
MS class	534
architecture	169
configuration	69, 173
configuration constants	173
demo application	176
endpoint	167
endpoint usage	167
functions	420
initialization	176
memory footprint	534
OS functions	428
porting	180–181
protocol	166
requests	167
state machine	172
storage layer functions	434
task handler	171
multiple class instances	99–103, 106–107

N

notification API	84
------------------	----

O

OS layer API	204
OS layer error codes	529

P

periodic input reports task	161–162
PHDC	184, 535
communication	192
communication API	192
configuration	69, 187, 191
configuration constants	188
data characteristics	184
demo application	201–202
endpoint	185
functions	442
initialization API	189
instance initialization	191
memory footprint	535–536
operational model	185
OS layer functions	463
porting	203
read	193
software layers	186

write	195
physical interface	21
pipe management	215
pipes	18
porting	
core layer	242
HID class	160
modules	239
MS class	180–181
PHDC	203
power distribution	22
power management	21
preprocessor constants	178
processing USB requests	61–62

Q

QoS	
bins	190
endpoint mapping	186
levels description	185
QoS-based schedule	196, 199
QoS-based scheduler API	198

R

RAM disk	177
receive	59–60
asynchronous	91
synchronous	89
report	136
descriptor content	139
items	138
mouse state	141
RTOS	
API functions	181
layer	171
model	240
port	238
QoS-based scheduler	196

S

sample application	40
building	31
SCSI	168
SCSI commands	170
SemaphorePost()	238
serial demo	132–134
state machine	133
serial read and write	128
serial terminal	134
SetBreak	122
SetCommFeature	122
SET_CONFIGURATION	110, 113
SET_CONTROL_LINE_STATE	132
SetControlLineState	122, 127
SET_FEATURE	113
SET_IDLE	161–162

SET_INTERFACE	113
SET_LINE_CODING	132
SetLineCoding	122, 127
SET_PROTOCOL	147
SET_REPORT	136, 147, 158
simple full-speed USB device	72
configuration	72
source code	37
downloading	28
including	37
speed	21
state machine	172
static stack configuration	65
status notification API	84
storage API	181
storage layer	171
functions	434
storage medium	171
string configuration	67
subclass	
management	127
notification	127
subclass instance	
communication	128
configuration	123
synchronous bulk read and write	151, 211
synchronous communication	150, 211
synchronous transfer completion	240

T

task	
execution order	197
model	58–59
priorities	69
task stack sizes	70
TaskCreate()	238
template files	33
trace functions	321
transfer types	18
transmit	59–60
asynchronous	95
synchronous	93

U

uC/FS preprocessor constants	178
UpdateAltSetting()	113
UpdateEPState()	113
USB	
class layer	56
core layer	56
data flow	20
device	16
device application	177
device configuration	66
device configuration structure	86
device controller driver configuration	85
device driver data type	80

device driver functional model	89
device states	25
device structure	22, 24
host	16
host application	179
USB_D_ACM_SerialAdd()	123–124, 126, 129, 370
USB_D_ACM_SerialCfgAdd()	123–124, 126, 371
USB_D_ACM_SERIAL_CFG_MAX_NBR_DEV	76, 123
USB_D_ACM_SerialInit()	123–124, 369
USB_D_ACM_SerialIsConn()	373
USB_D_ACM_SerialLineCodingGet()	127, 381
USB_D_ACM_SerialLineCodingReg()	123–124, 127, 383
USB_D_ACM_SerialLineCodingSet()	127, 382
USB_D_ACM_SerialLineCtrlGet()	127, 378
USB_D_ACM_SerialLineCtrlReg()	123–124, 127, 379
USB_D_ACM_SerialLineStateClr()	127, 386
USB_D_ACM_SerialLineStateSet()	127, 385
USB_D_ACM_SerialRx()	128, 374
USB_D_ACM_SerialTx()	128, 376
usb_d_bsp_<controller>.c	58
USB_D_BSP_Conn()	351
USB_D_BSP_Disconn()	352
USB_D_BSP_Init()	350
USB_D_BulkAdd()	265
USB_D_BulkRx()	89–90, 267
USB_D_BulkRxAsync()	91, 269
USB_D_BulkTx()	93, 271
USB_D_BulkTxAsync()	95, 273
USB_D_CDC_Add()	355
USB_D_CDC_CfgAdd()	358
USB_D_CDC_CFG_MAX_NBR_CFG	76, 120
USB_D_CDC_CFG_MAX_NBR_DATA_IF	120
USB_D_CDC_CFG_MAX_NBR_DEV	76, 120, 123
USB_D_CDC_DataIF_Add()	361
USB_D_CDC_DataRx()	363
USB_D_CDC_DataTx()	365
USB_D_CDC_Init()	354
USB_D_CDC_IsConn()	360
USB_D_CDC_Notify()	367
usb_d_cfg.c	34
usb_d_cfg.h	34, 55, 120, 123, 143, 187, 207, 232
USB_D_CfgAdd()	253
USB_D_CFG_DBG_TRACE_EN	68, 232
USB_D_CFG_DBG_TRACE_NBR_EVENTS	68, 232, 234
USB_D_CFG_MAX_NBR_CFG	66, 72, 74, 76
USB_D_CFG_MAX_NBR_DEV	66
USB_D_CFG_MAX_NBR_EP_DESC	67, 72, 74, 76
USB_D_CFG_MAX_NBR_EP_OPEN	67, 72, 74, 76
USB_D_CFG_MAX_NBR_IF	66, 72, 74, 76
USB_D_CFG_MAX_NBR_IF_ALT	67, 72, 74, 76
USB_D_CFG_MAX_NBR_IF_GRP	67, 72, 74, 76
USB_D_CFG_MAX_NBR_STR	67
USB_D_CFG_OPTIMIZE_SPD	66
USB_D_CfgOtherSpeed()	104
USB_D_CLASS_DRV	111

Index

usb_core.c	235	USB_EP_RxZLP()	287
usb_core.h	234	USB_EP_Stall()	292
USB_CoreTaskHandler()	242, 300	USB_EP_Tx()	93, 95–96
USB_CtrlRx()	89–90, 263	USB_EP_TxCmpl()	84, 94, 96, 314
USB_CtrlTx()	93, 261	USB_EP_TxZLP()	289
USB_Dbg()	234	USBDev_API	214
USB_DbgArg()	234	USBDev_API and WinUSB	215
USB_DbgTaskHandler()	243, 301	USBDev_API Asynchronous Read Example	219
USB_DevAdd()	42, 251	USBDev_API Device and Pipe Management API	215
USB_DEV_CFG	85, 156	USBDev_API Device and Pipe Management Example	217
usb_dev_cfg.c	34–35, 55, 85, 156	USBDev_API Functions	497
usb_dev_cfg.h	34, 55, 85	USBDev_API Synchronous Read and Write Example	218
USB_DevGetState()	249	USBDev_BulkIn_Open()	215, 218, 220, 509
USB_DEV_SPD_FULL	85	USBDev_BulkOut_Open()	215, 218, 510
USB_DEV_SPD_HIGH	85	USBDev_Close()	215, 500
USB_DEV_SPD_LOW	85	USBDev_CtrlReq()	517
USB_DevStart()	247	USBDev_EventConn()	83, 315
USB_DevStop()	248	USBDev_EventDisconn()	83, 316
USB_DrvAddrEn()	97, 330	USBDev_EventHS()	83, 318
USB_DrvAddrSet()	97, 329	USBDev_EventReset()	83, 317
USB_DRV_CFG	85	USBDev_EventResume()	83, 320
USB_DrvCfgClr()	332	USBDev_EventSetup()	84
USB_DrvCfgSet()	331	USBDev_EventSuspend()	83, 319
USB_DrvEP_Abort()	347	USBDev_GetCurAltSetting()	506
USB_DrvEP_Close()	336	USBDev_GetNbrAltSetting()	501
USB_DrvEP_Open()	334	USBDev_GetNbrAssociatedIF()	503
USB_DrvEP_Rx()	90, 92, 339	USBDev_GetNbrDev()	215, 497
USB_DrvEP_RxStart()	90–92, 337	USBDev_IntIn_Open()	215, 217
USB_DrvEP_RxZLP()	341	USBDev_IntOut_Open()	215, 217
USB_DrvEP_Stall()	348	USBDev_IntrIn_Open()	511
USB_DrvEP_Tx()	93, 95–96, 342	USBDev_IntrOut_Open()	512
USB_DrvEP_TxStart()	94, 96, 344	USBDev_IsHighSpeed()	508
USB_DrvEP_TxZLP()	346	USBDev_Open()	215, 499
USB_DrvGetFrameNbr()	333	USBDev_PipeAbort()	516
USB_DrvInit()	324	USBDev_PipeClose()	215, 514
USB_DrvISR_Handler()	81, 83, 349	USBDev_PipeGetAddr()	513
USB_DrvStart()	326	USBDev_PipeRd()	522
USB_DrvStop()	328	USBDev_PipeRdAsync()	524
USB_EP_Abort()	291	USBDev_PipeStall()	515
USB_EP_GetMaxNbrOpen()	297	USBDev_PipeWr()	520
USB_EP_GetMaxPhyNbr()	296	USBDev_SetAltSetting()	504
USB_EP_GetMaxPktSize()	295	USB_HID_Add()	144, 147, 151, 389
USB_EP_INFO_DIR	87	USB_HID_CfgAdd()	144–145, 147, 391
USB_EP_INFO_DIR_IN	87	USB_HID_CFG_MAX_NBR_CFG	76, 143
USB_EP_INFO_DIR_OUT	87	USB_HID_CFG_MAX_NBR_DEV	76, 143
USB_EP_INFO_TYPE	87	USB_HID_CFG_MAX_NBR_REPORT_ID	143
USB_EP_INFO_TYPE_BULK	87	USB_HID_CFG_MAX_NBR_REPORT_PUSHPOP	143
USB_EP_INFO_TYPE_CTRL	87	USB_HID_Init()	144, 388
USB_EP_INFO_TYPE_INTR	87	USB_HID_IsConn()	393
USB_EP_INFO_TYPE_ISOC	87	USB_HID_OS_CFG_TMR_TASK_PRIO	143
USB_EP_IsStalled()	294	USB_HID_OS_CFG_TMR_TASK_STK_SIZE	143
USB_EP_Process()	92	USB_HID_OS_Init()	161, 402
USB_EP_Rx()	90–91	USB_HID_OS_InputDataPend()	161, 405
USB_EP_RxCmpl()	84, 90, 92, 313	USB_HID_OS_InputDataPendAbort()	161, 407

USBD_HID_OS_InputDataPost()	161, 408	USBD_OS_EP_SignalCreate()	238, 242, 302
USBD_HID_OS_InputLock()	161, 403	USBD_OS_EP_SignalDel()	242, 304
USBD_HID_OS_InputUnlock()	161, 404	USBD_OS_EP_SignalPend()	242, 305
USBD_HID_OS_OutputDataPend()	161, 411	USBD_OS_EP_SignalPost()	242, 308
USBD_HID_OS_OutputDataPendAbort()	161, 413	USBD_OS_Init()	242, 298
USBD_HID_OS_OutputDataPost()	161, 414	USBD_OS_Q_Post()	238
USBD_HID_OS_OutputLock()	161, 409	USBD_OS_SemCreate()	238
USBD_HID_OS_OutputUnlock()	161, 410	USBD_OS_TaskCreate()	238
USBD_HID_OS_TmrTask	161	USBD_PHDC_11073_ExtCfg()	189–190, 452
USBD_HID_OS_TmrTask()	417	USBD_PHDC_Add()	189, 193, 195, 443
USBD_HID_OS_TxLock()	161, 415	USBD_PHDC_CfgAdd()	189–190, 445
USBD_HID_OS_TxUnlock()	161, 416	USBD_PHDC_CFG_DATA_OPAQUE_MAX_LEN	187
USBD_HID_Rd()	150, 158, 160, 394	USBD_PHDC_CFG_MAX_NBR_CFG	74, 187
USBD_HID_RdAsync()	150, 396	USBD_PHDC_CFG_MAX_NBR_DEV	74, 187
USBD_HID_Wr()	150, 157–158, 160, 163, 398	USBD_PHDC_Init()	189, 442
USBD_HID_WrAsync()	150, 400	USBD_PHDC_IsConn()	447
USBD_IF_Add()	255	USBD_PHDC_LATENCY_HIGH_RELY_BEST	190
USBD_IF_AltAdd()	257	USBD_PHDC_LATENCY_LOW_RELY_GOOD	190
USBD_IF_Grp()	259	USBD_PHDC_LATENCY_MEDIUM_RELY_BEST	190
USBD_Init()	42, 246	USBD_PHDC_LATENCY_MEDIUM_RELY_BETTER	190
USBD_IntrAdd()	276	USBD_PHDC_LATENCY_MEDIUM_RELY_GOOD	190
USBD_IntrRx()	89–90, 278	USBD_PHDC_LATENCY_VERYHIGH_RELY_BEST	190
USBD_IntrRxAsync()	91, 280	USBD_PHDC_OS_CFG_SCHED_EN	188
USBD_IntrTx()	93, 282	USBD_PHDC_OS_CFG_SCHED_TASK_PRIO	188
USBD_IntrTxAsync()	95, 284	USBD_PHDC_OS_CFG_SCHED_TASK_STK_SIZE	188
USBD_MSC_Add()	174, 421	USBD_PHDC_OS_CFG_Init()	463
USBD_MSC_CfgAdd()	174, 422	USBD_PHDC_OS_RdLock()	464
USBD_MSC_CFG_DATA_LEN	173	USBD_PHDC_OS_RdUnLock()	466
USBD_MSC_CFG_MAX_LUN	173	USBD_PHDC_OS_WrBulkLock()	198–199, 469
USBD_MSC_CFG_MAX_NBR_CFG	74, 173	USBD_PHDC_OS_WrBulkSchedTask()	198
USBD_MSC_CFG_MAX_NBR_DEV	74, 173	USBD_PHDC_OS_WrBulkUnLock()	471
USBD_MSC_Init()	174, 420	USBD_PHDC_OS_WrBulkUnlock()	198–199
USBD_MSC_IsConn()	426	USBD_PHDC_OS_WrIntrLock()	467
USBD_MSC_LunAdd()	174–175, 424	USBD_PHDC_OS_WrIntrUnLock()	468
USBD_MSC_OS_CFG_TASK_PRIO	173	USBD_PHDC_Rd()	192–193, 456
USBD_MSC_OS_CFG_TASK_STK_SIZE	173	USBD_PHDC_RdCfg()	189–190, 448
USBD_MSC_OS_CommSignalDel()	181, 431	USBD_PHDC_RdPreamble()	192–193, 196, 454
USBD_MSC_OS_CommSignalPend()	181, 430	USBD_PHDC_Reset()	462
USBD_MSC_OS_CommSignalPost()	181, 429	USBD_PHDC_Wr()	192, 194, 460
USBD_MSC_OS_EnumSignalPend()	181, 433	USBD_PHDC_WrCfg()	189–190, 450
USBD_MSC_OS_EnumSignalPost()	181, 432	USBD_PHDC_WrPreamble()	192, 194, 196
USBD_MSC_OS_Init()	181, 428	USBD_PHDC_Wrpreamble()	458
USBD_MSC_TaskHandler()	427	USBD_RAMDISK_CFG_BASE_ADDR	177
usb_os.c	242	USBD_RAMDISK_CFG_BLK_SIZE	177
USBD_OS_CFG_CORE_TASK_PRIO	70	USBD_RAMDISK_CFG_NBR_BLKs	177
USBD_OS_CFG_CORE_TASK_STK_SIZE	70	USBD_RAMDISK_CFG_NBR_UNITS	177
USBD_OS_CFG_TRACE_TASK_PRIO	70	USBD_StorageCapacityGet()	181, 435
USBD_OS_CFG_TRACE_TASK_STK_SIZE	70	USBD_StorageInit()	181, 434
USBD_OS_CoreEventGet()	242, 310	USBD_StorageRd()	181, 436
USBD_OS_CoreEventPut()	238, 242, 309	USBD_StorageStatusGet()	181, 439
USBD_OS_DbgEventRdy()	242, 311	USBD_StorageWr()	181, 437
USBD_OS_DbgEventWait()	312	USBD_Trace()	63, 321
USBD_OS_DbgEventWait()	242	USBD_Trace() Example	232
USBD_OS_EP_SignalAbort()	242, 307	USBD_Vendor_Add()	208, 210–211, 475

Index

USB_D_Vendor_CfgAdd()	208, 210, 477
USB_D_VENDOR_CFG_MAX_NBR_CFG	72, 76, 207
USB_D_VENDOR_CFG_MAX_NBR_DEV	72, 76, 207
USB_D_Vendor_Init()	208, 474
USB_D_Vendor_IntrRd()	210, 212, 489
USB_D_Vendor_IntrRdAsync()	210, 214, 493
USB_D_Vendor_IntrWr()	210, 212, 491
USB_D_Vendor_IntrWrAsync()	210, 214, 495
USB_D_Vendor_IsConn()	479
USB_D_Vendor_Rd()	210, 481
USB_D_Vendor_RdAsync()	210, 485
USB_D_Vendor_Wr()	210, 483
USB_D_Vendor_WrAsync()	210, 487
USB_D_XXXX_Add()	99, 101, 103, 107
USB_D_XXXX_CfgAdd()	99, 101, 103
USB_D_XXXX_CFG_MAX_NBR_CFG	99
USB_D_XXXX_CFG_MAX_NBR_DEV	99
usbser.sys	130

V

Vendor class	537
architecture	206
communication	210
communication API	210
configuration	69, 207
configuration constants	207
demo application	224, 226
endpoints	207
functions	474
initialization	209
initialization API	208
memory footprint	537
VendorReq()	113
virtual COM port	131

W

Windows application constants	222
Windows drivers	47
Winusb.dll	214
Winusb.sys	214
WinUSB_composite.inf	223, 229
WinUSB_single.inf	229
wrapper	238

Mouser Electronics

Authorized Distributor

Click to View Pricing, Inventory, Delivery & Lifecycle Information:

[Analog Devices Inc.:](#)

[AD-UCUSB-DCCDC-SPL](#) [AD-UCUSBD-MPHD-SPL](#) [AD-UCUSB-DCPHD-SPL](#) [AD-UCUSBD-SPRD](#) [AD-UCUSB-DCMSC-SPL](#) [AD-UCUSBD-MMSC-SPL](#) [AD-UCUSB-DCVNDRSPL](#) [AD-UCUSBD-MCDC-SPL](#) [AD-UCUSBD-MAUD-SPL](#) [AD-UCUSBD-MVNDRSPL](#) [AD-UCUSBD-MNT-SP](#) [AD-UCUSB-DCHID-SPL](#) [AD-UCUSBD-MHID-SPL](#)

Компания «Океан Электроники» предлагает заключение долгосрочных отношений при поставках импортных электронных компонентов на взаимовыгодных условиях!

Наши преимущества:

- Поставка оригинальных импортных электронных компонентов напрямую с производств Америки, Европы и Азии, а так же с крупнейших складов мира;
- Широкая линейка поставок активных и пассивных импортных электронных компонентов (более 30 млн. наименований);
- Поставка сложных, дефицитных, либо снятых с производства позиций;
- Оперативные сроки поставки под заказ (от 5 рабочих дней);
- Экспресс доставка в любую точку России;
- Помощь Конструкторского Отдела и консультации квалифицированных инженеров;
- Техническая поддержка проекта, помощь в подборе аналогов, поставка прототипов;
- Поставка электронных компонентов под контролем ВП;
- Система менеджмента качества сертифицирована по Международному стандарту ISO 9001;
- При необходимости вся продукция военного и аэрокосмического назначения проходит испытания и сертификацию в лаборатории (по согласованию с заказчиком);
- Поставка специализированных компонентов военного и аэрокосмического уровня качества (Xilinx, Altera, Analog Devices, Intersil, Interpoint, Microsemi, Actel, Aeroflex, Peregrine, VPT, Syfer, Eurofarad, Texas Instruments, MS Kennedy, Miteq, Cobham, E2V, MA-COM, Hittite, Mini-Circuits, General Dynamics и др.);

Компания «Океан Электроники» является официальным дистрибьютором и эксклюзивным представителем в России одного из крупнейших производителей разъемов военного и аэрокосмического назначения «JONHON», а так же официальным дистрибьютором и эксклюзивным представителем в России производителя высокотехнологичных и надежных решений для передачи СВЧ сигналов «FORSTAR».



JONHON

«JONHON» (основан в 1970 г.)

Разъемы специального, военного и аэрокосмического назначения:

(Применяются в военной, авиационной, аэрокосмической, морской, железнодорожной, горно- и нефтедобывающей отраслях промышленности)

«FORSTAR» (основан в 1998 г.)

ВЧ соединители, коаксиальные кабели,
кабельные сборки и микроволновые компоненты:

(Применяются в телекоммуникациях гражданского и специального назначения, в средствах связи, РЛС, а так же военной, авиационной и аэрокосмической отраслях промышленности).



Телефон: 8 (812) 309-75-97 (многоканальный)

Факс: 8 (812) 320-03-32

Электронная почта: ocean@oceanchips.ru

Web: <http://oceanchips.ru/>

Адрес: 198099, г. Санкт-Петербург, ул. Калинина, д. 2, корп. 4, лит. А