

THIS DRAWING IS UNPUBLISHED.

RELEASED FOR PUBLICATION

© COPYRIGHT - By -

ALL RIGHTS RESERVED.

LOC GP DIST 00

REVISIONS

P	LTR	DESCRIPTION	DATE	DWN	APVD
	H1	ECR-11-025464	16DEC11	RK	BVH

NOTES:

- △ PITCH TOLERANCE TO BE ±.18[.007] FOR 1.27[.050] PITCH JUMPERS & ±.25[.010] FOR ALL REMAINING PITCHES. TOLERANCE TO BE NON CUMULATIVE OVER GAUGE LENGTH.
- △ 11.92-152.40[.500-6.000] ARE STANDARD LENGTHS. JUMPERS ARE AVAILABLE IN INCREMENTS OF 2.50[.10] PLUS 6.35[.25] AND 19.05[.75].
- △ DELETED
- △ FOR CONDUCTOR PITCH 7 (2mm), ON PAGE 2 & 3, DIMENSION "B" IS 2.00[.079]
- △ SPECIAL PIN LENGTHS ARE AVAILABLE FOR JUMPERS WITH A PIN CONFIGURATION OF "A" OR "B" ON LENGTHS OF UP TO 609.6[24.0] IN 2.54[.100] & 5.08[.200] PITCH VARIANTS ONLY BY ADDING THE FOLLOWING SUFFIXES:

SUFFIX	PEN LENGTH	TOLERANCE
V1	2.85 (.112)	±.305 [±.012]
V2	3.40 (.134)	
V3	4.10 (.161)	
V4	6.50 (.256)	
V5	3.10 (.122)	
V6	2.81 (.150)	
V7	4.50 (.177)	
V8	2.00 (.079)	
V9	TBD	
V10	.76 (.030)	
V11	2.41 (.095)	

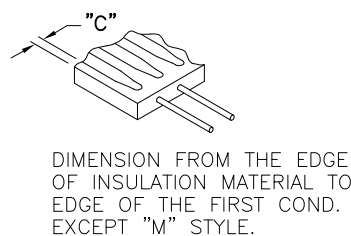

6. RECOMMENDED PCB HOLE DRILLING DETAILS ARE AS FOLLOWS:-

PITCH A	ØG
1.27 (.050)	.70 (.028)
1.90 (.075)	.80 (.031)
2.54 (.100)	.95 (.037)
3.18 (.125)	.95 (.037)
3.81 (.150)	.95 (.037)
5.08 (.200)	.95 (.037)

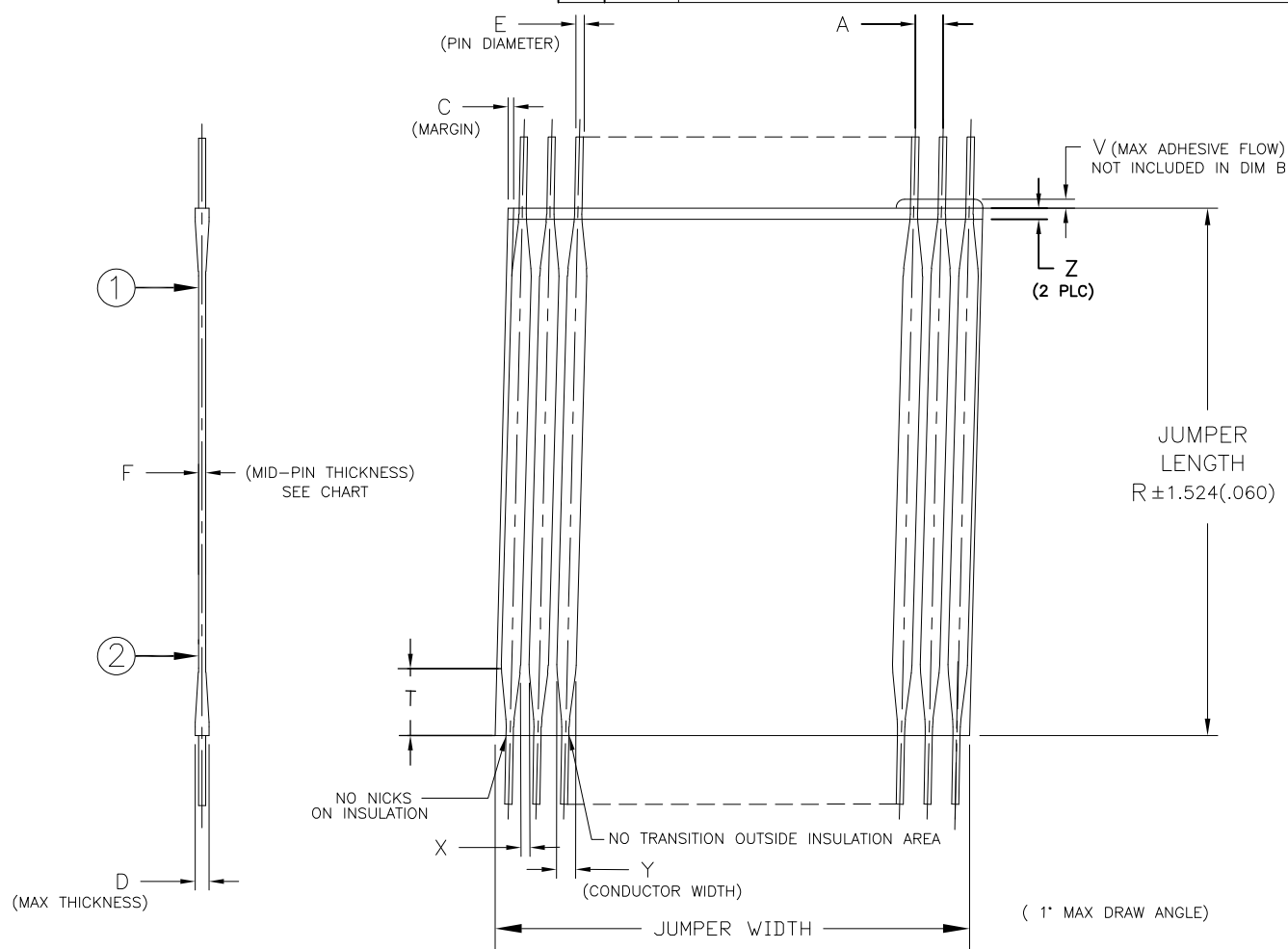
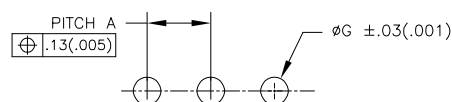

JUMPER LENGTH	PITCH (NOMINAL)	TRANSITION MAX	MAX/MIN MARGIN	△ PIN DIAMETER	WIRE GAUGE (AWG)	MIN/MAX No OF CONDUCTORS	MAXIMUM ADHESIVE FLOW	MIN GAP BETWEEN CONDUCTORS	CONDUCTOR WIDTH	MAXIMUM INSULATION MISMATCH	MAX THICKNESS
R △ ₂	A △ ₁	T	C	E	-	-	V	X	Y	Z	D
11.93 (.50) TO 863.6 (30.00) IN STEPS OF 2.50 (.10) PLUS 6.35 (.25) AND 19.05 (.75)	1.00 (0.039)	4.32 [.170]	0.35 (0.014) 0.17 (.007)	0.330 (.0130) 0.317 (.0125)	28	2-70	0.38 (0.015)	0.13 (0.009)	0.76 (.030) 0.56 (.022)	.76 (.030)	.64
	1.25 (0.049)	4.32 [.170]	0.50 (0.020) 0.17 (0.007)	0.330 (0.0130) 0.317 (0.0125)	28	2-70	0.38 (0.015)	0.25 (0.010)	0.89 (.035) 0.64 (.025)	.76 (.030)	.64
	1.27 (0.050)	4.32 [.170]	0.50 (0.020) 0.17 (0.007)	0.330 (0.0130) 0.317 (0.0125)	28	2-70	0.38 (0.015)	0.25 (0.010)	0.89 (.035) 0.64 (.025)	.76 (.030)	.64
	2.00 (0.079)	5.08 [.200]	0.70 (0.028) 0.25 (0.010)	0.416 (0.0164) 0.400 (0.0157)	26	2-50	0.38 (0.015)	0.38 (0.015)	1.14 (.045) 0.89 (.035)	.76 (.030)	.84
	1.90 (0.075)	5.08 [.200]	0.70 (0.028) 0.25 (0.010)	0.416 (0.0164) 0.400 (0.0157)	26	2-50	0.38 (0.015)	0.38 (0.015)	1.14 (.045) 0.89 (.035)	.76 (.030)	.84
	2.54 (0.100)	6.35 [.250]	0.80 (0.031) 0.25 (0.010)	0.526 (0.0207) 0.505 (0.0199)	24	2-50	0.51 (0.020)	0.51 (0.020)	1.52 (.060) 1.27 (.050)	.76 (.030)	.84
	3.18 (0.125)	6.35 [.250]	1.00 (0.039) 0.25 (0.010)	0.526 (0.0207) 0.505 (0.0199)	24	2-25	0.51 (0.020)	0.51 (0.020)	1.52 (.060) 1.27 (.050)	.76 (.030)	.84
	3.81 (0.150)	6.35 [.250]	1.00 (0.039) 0.25 (0.010)	0.526 (0.0207) 0.505 (0.0199)	24	2-20	0.51 (0.020)	0.51 (0.020)	1.52 (.060) 1.27 (.050)	.76 (.030)	.84
	5.08 (0.200)	6.35 [.250]	1.00 (0.039) 0.25 (0.010)	0.526 (0.0207) 0.505 (0.0199)	24	2-15	0.51 (0.020)	0.51 (0.020)	1.52 (.060) 1.27 (.050)	.76 (.030)	.84

- △ BEND RADIUS TO APPLY ONLY IN THE FLAT SECTION OF JUMPER BETWEEN THE CONDUCTOR TRANSITION AREAS.
- △ PER 108-2135.
- 9. TOOL MARKS PERMISSIBLE ON BENDS. NO EXPOSED COPPER.
- △ PIN DIAMETER SPECIFIED NOT APPLICABLE IN BENDING AREA OF PIN, DUE TO NORMAL DEFORMATION OF BENDING PROCESS.
- △ REFER TO RELEVANT MATERIAL SPECIFICATIONS.

F - MID POINT THICKNESS BETWEEN PT 1 & PT 2	MINIMUM	MAXIMUM
	NOMEX®	.152 [.006]
POLYESTER	.152 [.006]	.305 [.012]
KAPTON®	.102 [.004]	.254 [.010]
TEFLON®	.305 [.012]	.533 [.021]

12. PRODUCT AND PROCESSING MUST MEET REQUIREMENTS OF TE CONNECTIVITY STANDARD 230-702.

Nomex®, Teflon® and Kapton® are trademarks of E. I. DuPont de Nemours.

THIS DRAWING IS A CONTROLLED DOCUMENT.

DWN J. SCHWARTZ 28FEB01
CHK E. FOX 28FEB01
APVD E. FOX 28FEB01

STE TE Connectivity

NAME FLEXSTRIP PIN CONFIGURATIONS, GENERIC

PRODUCT SPEC

APPLICATION SPEC

SIZE A3 CAGE CODE 00779 DRAWING NO C-1474339 RESTRICTED TO

WEIGHT -

CUSTOMER DRAWING SCALE N.T.S. SHEET 1 OF 4 REV H1

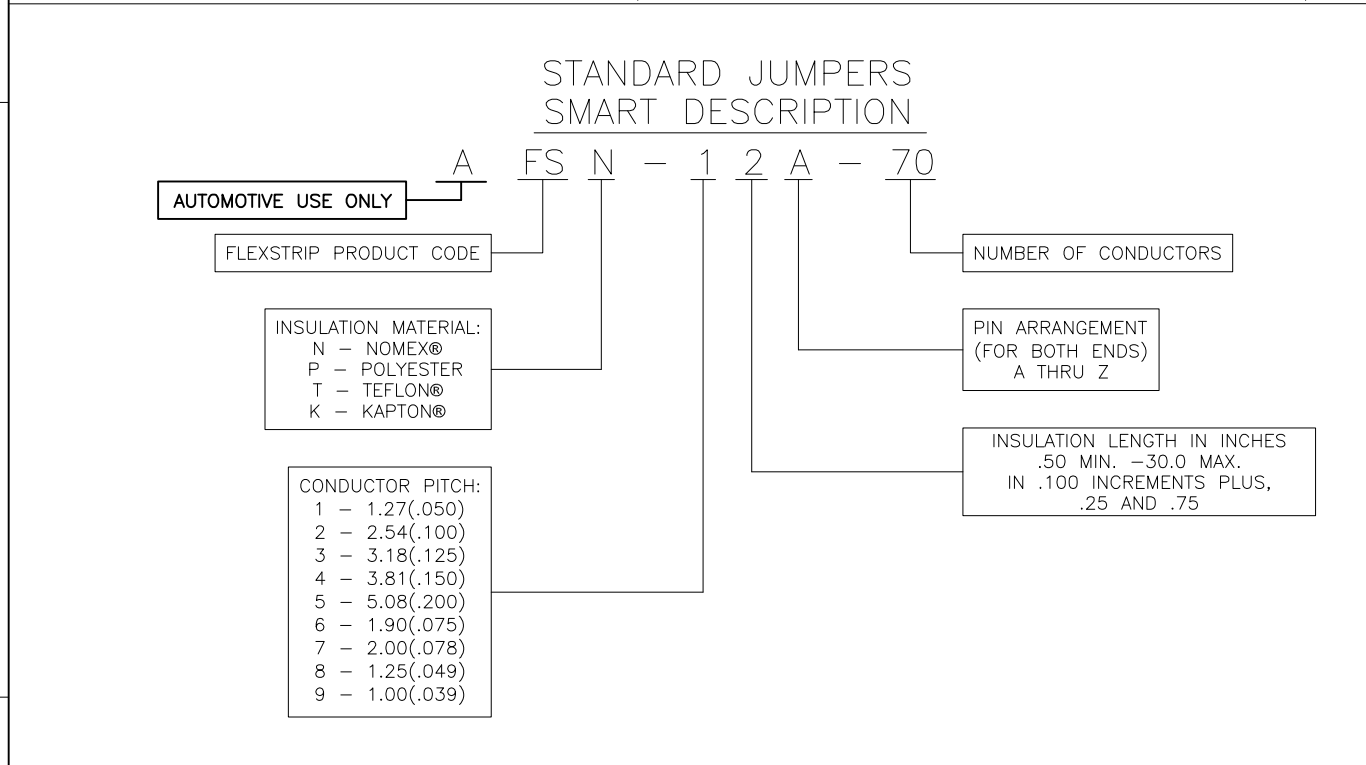

MANUFACTURING NOTE:

MINIMUM GAP BETWEEN STRIPS

SK/A/Z	.75 INCH
LP	1.1 INCH

MINIMUM CONDUCTOR COUNT PER STRIP FOR LINE JOBS

PITCH	CONDUCTOR
1 1.27 (.050)	60
2 2.54 (.100)	60
3 3.18 (.125)	60
4 3.81 (.150)	50
5 5.08 (.200)	40
6 1.91 (.075)	60
7 2.0 (.078)	60
8 1.24 (.049)	60
9 1.0 (.039)	80

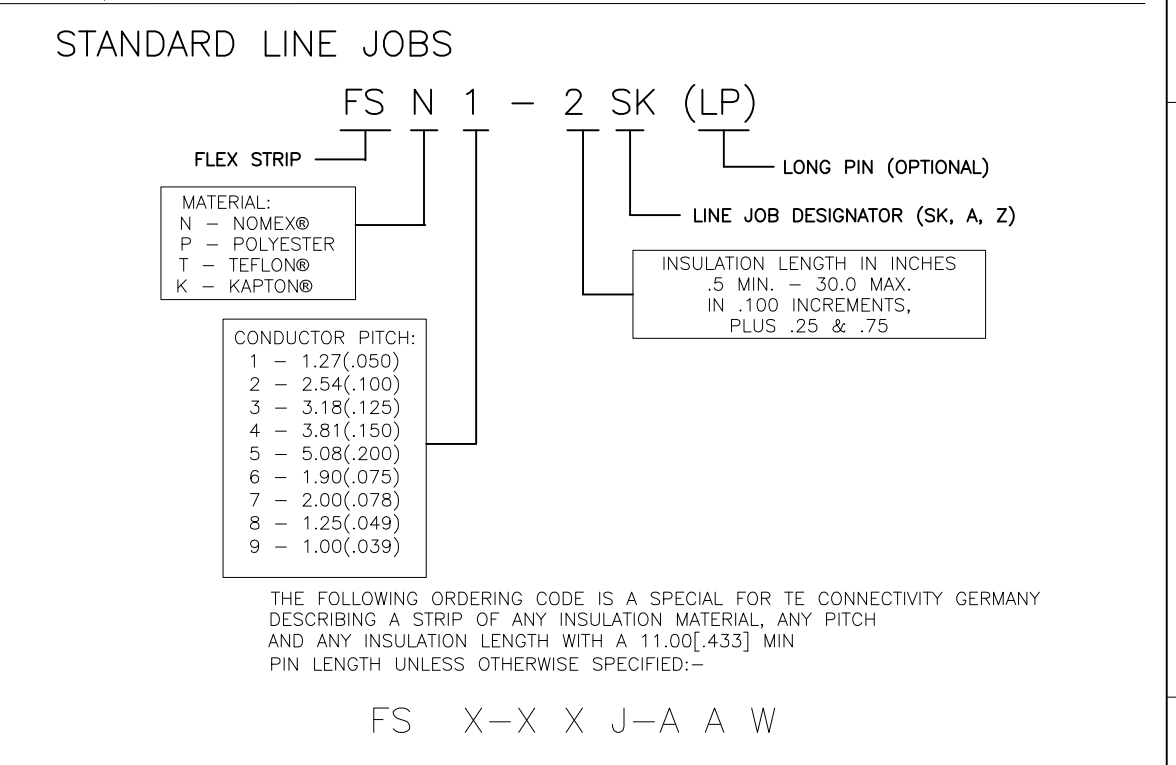

Nomex®, Teflon® and Kapton® are trademarks of E. I. DuPont de Nemours.

THIS DRAWING IS A CONTROLLED DOCUMENT.

DIMENSIONS: MM [INCHES]	TOLERANCES UNLESS OTHERWISE SPECIFIED:
0 PLC	± -
1 PLC	± -
2 PLC	± -
3 PLC	± -
4 PLC	± -
ANGLES	± 1/2°
MATERIAL	FINISH

DWN	J. SCHWARTZ	28FEB01	 TE Connectivity
CHK	E. FOX	28FEB01	
APVD	E. FOX	28FEB01	
PRODUCT SPEC	NAME		
APPLICATION SPEC	FLEXSTRIP PIN CONFIGURATIONS, GENERIC		RESTRICTED TO
WEIGHT	-	-	SIZE
CUSTOMER DRAWING	A3	00779	CAGE CODE
SCALE	N.T.S.	DRAWING NO	RESTRICTED TO
SHEET	2 OF 4	C=1474339	REV
REVISIONS	H1		

THIS DRAWING IS UNPUBLISHED. RELEASED FOR PUBLICATION
 © COPYRIGHT - By - ALL RIGHTS RESERVED.

LOC	DIST	REVISIONS					
GP	00	P	LTR	DESCRIPTION	DATE	DWN	APVD
		-		SEE SHEET 1	-	-	-

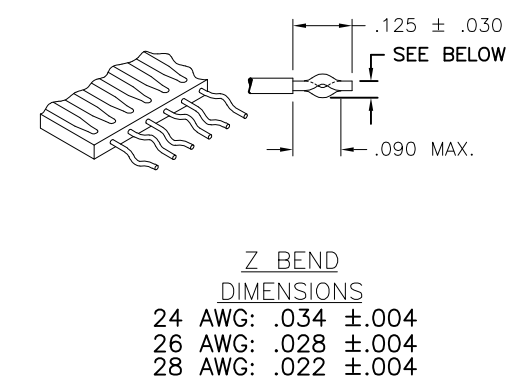

**SPECIAL JUMPERS
SMART DESCRIPTION**

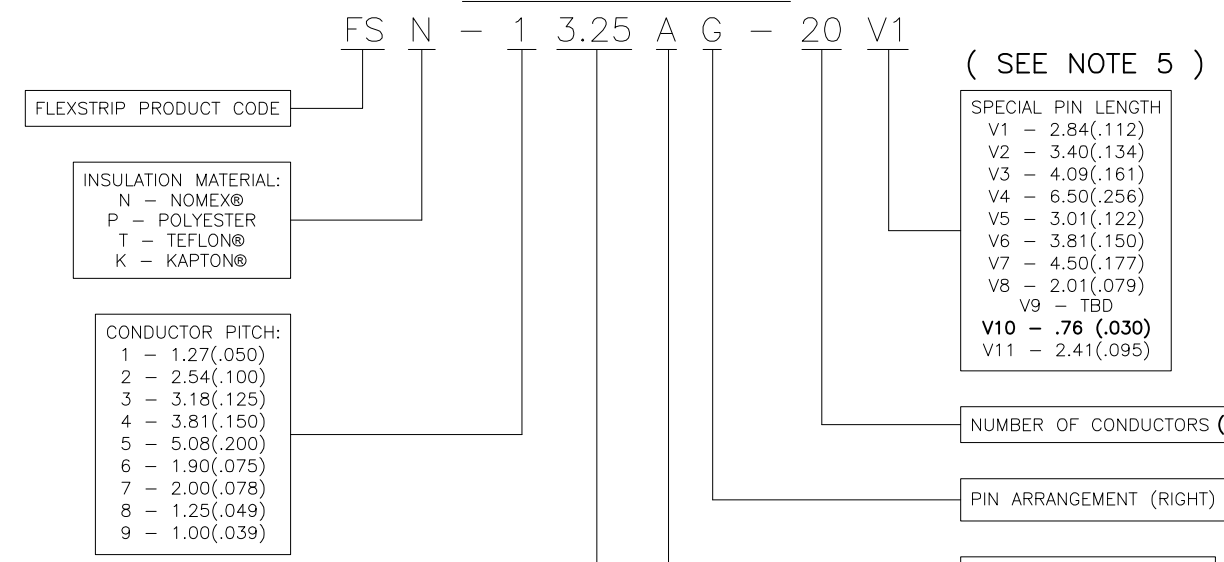

CONDUCTOR PITCH	BENDS AVAILABLE
1 - 1.27/(.050)	E,F,G,H,J,K,L
2 - 2.54/(.100)	E,F,G,H,J,K,L
3 - 3.18/(.125)	E
4 - 3.81/(.150)	E
5 - 5.08/(.200)	E
6 - 1.91/(.075)	E,F,G,H,J,K,L
7 - 2.00/(.0787)	E,F,G,H,J,K,L
8 - 1.25/(.049)	E
9 - 1.00/(.039)	E

E THRU L BEND
"A" DIM
3.18±0.76/(.125±.030)
"B" DIM
2.54±0.25/(.100±.010)

SPECIAL FLEXSTRIP BENDS
 SPECIAL FLEXSTRIP BENDS
 E THRU R, AND Z MAY APPLY TO EITHER
 LEFT OF RIGHT SIDE

INSULATION LENGTH: (in inches)
 .50 MIN. - 30.0 MAX.
 IN .10 INCREMENTS PLUS .25 AND .75

Nomex®, Teflon® and Kapton® are trademarks of E. I. DuPont de Nemours.

THIS DRAWING IS A CONTROLLED DOCUMENT.

DIMENSIONS: MM [INCHES]	TOLERANCES UNLESS OTHERWISE SPECIFIED: 0 PLC ± - 1 PLC ± - 2 PLC ± - 3 PLC ± - 4 PLC ± - ANGLES ± 1/2°	DWN J. SCHWARTZ 28FEB01	TE Connectivity
	MATERIAL	CHK E. FOX 28FEB01	
	FINISH	APVD E. FOX 28FEB01	
		NAME FLEXSTRIP PIN CONFIGURATIONS, GENERIC	
		PRODUCT SPEC	SIZE A3
		APPLICATION SPEC	CAGE CODE 00779
		WEIGHT	DRAWING NO C-1474339
			RESTRICTED TO
		CUSTOMER DRAWING	SCALE N.T.S.
			SHEET 3 OF 4
			REV H1

THIS DRAWING IS UNPUBLISHED. RELEASED FOR PUBLICATION
 © COPYRIGHT - By - ALL RIGHTS RESERVED.

LOC GP	DIST 00	REVISIONS		
P	LTR	DESCRIPTION	DATE	DWN -
		SEE SHEET 1	-	APVD -

NORMAL CONDUCTOR PITCH		1.00 (.039)	1.25 (.049)	1.27 (.050)	1.90 (.075)	2.00 (.078)	2.54 (.100)	3.18 (.125)	3.81 (.150)	5.08 (.200)
WIRE GAUGE		AWG 28	AWG 28	AWG 28	AWG 26	AWG 26	AWG 24	AWG 24	AWG 24	AWG 24
NOMINAL WIRE DIAMETER		.32(.0126)	.32(.0126)	.32(.0126)	.40(.0159)	.40(.0159)	.51(.0201)	.51(.0201)	.51(.0201)	.51(.0201)
CURRENT RATING		8	8	8	8	8	8	8	8	8
VOLTAGE RATING		8	8	8	8	8	8	8	8	8
MAX NUMBER OF CONDUCTORS PER JUMPER		8	8	8	8	8	8	8	8	8
MIN BREAKDOWN VOLTAGE @ 1 MIN		8	8	8	8	8	8	8	8	8
INSULATION RESISTANCE (GND. SIG. GND) 305 (12") SAMPLE @ 500VDC	P N T K	8	8	8	8	8	8	8	8	8
CAPACITANCE (pf / 50.8 (12") LENGTH) (GND, SIG, GND) (AVERAGE)	P N T K	8	8	8	8	8	8	8	8	8
CHARACTERISTIC IMPEDANCE (GND. SIG. GND) (AVERAGE)	P N T K	8	8	8	8	8	8	8	8	8
APPLICATION TEMP RANGE (C°) (FOR SOLDERING)	P N T K	200 / 4 sec 200 / 4 sec 240 / 4 sec 240 / 4 sec	200 / 4 sec 200 / 4 sec 240 / 4 sec 240 / 4 sec	200 / 4 sec 200 / 4 sec 240 / 4 sec 240 / 4 sec	200 / 4 sec 200 / 4 sec 240 / 4 sec 240 / 4 sec	200 / 4 sec 200 / 4 sec 240 / 4 sec 240 / 4 sec	250 / 4 sec 250 / 4 sec 260 / 5 sec 260 / 5 sec	250 / 4 sec 250 / 4 sec 260 / 5 sec 260 / 5 sec	250 / 4 sec 250 / 4 sec 260 / 5 sec 260 / 5 sec	250 / 4 sec 250 / 4 sec 260 / 5 sec 260 / 5 sec
OPERATING TEMPERATURE (C°)	P N T K	-40 to 105 (For all Conductor Pitches) -40 to 125 (For all Conductor Pitches) -40 to 150 (For all Conductor Pitches) -40 to 150 (For all Conductor Pitches)								
MINIMUM BEND RADIUS	P N T K	3.18mm (For all Conductor Pitches) 3.18mm (For all Conductor Pitches) 3.18mm (For all Conductor Pitches) 3.18mm (For all Conductor Pitches)								
UL STYLE NUMBER	P N T K	2639 (For all Conductor Pitches .100 and above) 5456 (For all Conductor Pitches .100 and above) 2928 (For all Conductor Pitches .100 and above) 2927 (For all Conductor Pitches .100 and above)								

ABR.	MATERIAL	SPECIFICATION
	COPPER WIRE	100-1577
P	POLYESTER	100-1575
N	NOMEX®	100-1758
T	TEFLON®	100-1574
K	KAPTON®	100-1576

Nomex®, Teflon® and Kapton® are trademarks of E. I. DuPont de Nemours.

THIS DRAWING IS A CONTROLLED DOCUMENT.		DWN J. SCHWARTZ 28FEB01	TE Connectivity	
		CHK E. FOX 28FEB01		
DIMENSIONS: MM [INCHES]		APVD E. FOX 28FEB01	NAME FLEXSTRIP PIN CONFIGURATIONS, GENERIC	
		PRODUCT SPEC -	-	
TOLERANCES UNLESS OTHERWISE SPECIFIED:		APPLICATION SPEC -	-	
0 PLC ± - 1 PLC ± - 2 PLC ± - 3 PLC ± - 4 PLC ± - ANGLES ± 1/2°		SIZE A3	CAGE CODE 00779	DRAWING NO C-1474339
MATERIAL -		FINISH -	RESTRICTED TO -	SCALE N.T.S.
CUSTOMER DRAWING			SHEET 4 OF 4	REV H1

Компания «Океан Электроники» предлагает заключение долгосрочных отношений при поставках импортных электронных компонентов на взаимовыгодных условиях!

Наши преимущества:

- Поставка оригинальных импортных электронных компонентов напрямую с производств Америки, Европы и Азии, а так же с крупнейших складов мира;
- Широкая линейка поставок активных и пассивных импортных электронных компонентов (более 30 млн. наименований);
- Поставка сложных, дефицитных, либо снятых с производства позиций;
- Оперативные сроки поставки под заказ (от 5 рабочих дней);
- Экспресс доставка в любую точку России;
- Помощь Конструкторского Отдела и консультации квалифицированных инженеров;
- Техническая поддержка проекта, помощь в подборе аналогов, поставка прототипов;
- Поставка электронных компонентов под контролем ВП;
- Система менеджмента качества сертифицирована по Международному стандарту ISO 9001;
- При необходимости вся продукция военного и аэрокосмического назначения проходит испытания и сертификацию в лаборатории (по согласованию с заказчиком);
- Поставка специализированных компонентов военного и аэрокосмического уровня качества (Xilinx, Altera, Analog Devices, Intersil, Interpoint, Microsemi, Actel, Aeroflex, Peregrine, VPT, Syfer, Eurofarad, Texas Instruments, MS Kennedy, Miteq, Cobham, E2V, MA-COM, Hittite, Mini-Circuits, General Dynamics и др.);

Компания «Океан Электроники» является официальным дистрибьютором и эксклюзивным представителем в России одного из крупнейших производителей разъемов военного и аэрокосмического назначения «JONHON», а так же официальным дистрибьютором и эксклюзивным представителем в России производителя высокотехнологичных и надежных решений для передачи СВЧ сигналов «FORSTAR».



JONHON

«JONHON» (основан в 1970 г.)

Разъемы специального, военного и аэрокосмического назначения:

(Применяются в военной, авиационной, аэрокосмической, морской, железнодорожной, горно- и нефтедобывающей отраслях промышленности)

«FORSTAR» (основан в 1998 г.)

ВЧ соединители, коаксиальные кабели,
кабельные сборки и микроволновые компоненты:

(Применяются в телекоммуникациях гражданского и специального назначения, в средствах связи, РЛС, а так же военной, авиационной и аэрокосмической отраслях промышленности).



Телефон: 8 (812) 309-75-97 (многоканальный)

Факс: 8 (812) 320-03-32

Электронная почта: ocean@oceanchips.ru

Web: <http://oceanchips.ru/>

Адрес: 198099, г. Санкт-Петербург, ул. Калинина, д. 2, корп. 4, лит. А