



GaAs HBT HIGH LINEARITY PUSH-PULL AMPLIFIER, 75 Ohm, DC - 1 GHz

Typical Applications

The HMC754S8GE is ideal for:

- CATV / Broadband Infrastructure
- Test & Measurement Equipment
- Line Amps and Fiber Nodes
- Customer Premise Equipment

Features

- Output IP2: +78 dBm
- High Gain: 14.5 dB
- High Output IP3: +38 dBm
- 75 Ohm Impedance
- Single Positive Supply: +5V
- Robust 1000V ESD, Class 1C
- SOIC-8 SMT Package

Functional Diagram

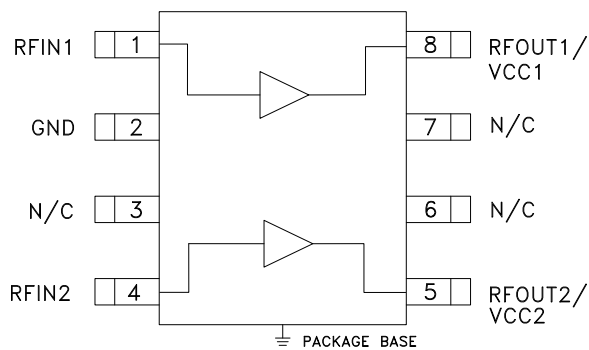

General Description

The HMC754S8GE is a GaAs/InGaP HBT Dual Channel Gain Block MMIC SMT amplifier covering DC to 1 GHz. This versatile product contains two gain blocks, packaged in a single 8 lead plastic SOIC-8, for use with both amplifiers combined in push-pull configuration using external baluns to cancel out second order non-linearities and improve IP2 performance. In this configuration, the HMC754S8GE offers high gain, very low distortion & simple external matching. This high linearity amplifier consumes only 160mA from a single positive supply.

Electrical Specifications, $T_A = +25^\circ \text{C}$, $V_{cc1} = V_{cc2} = 5\text{V}$, $Z_o = 75 \text{ Ohm}$ [1]

| Parameter | | Min. | Typ. | Max. | Units |
|---|-----------------|------|-------|------|--------|
| Gain | 0.05 - 0.5 GHz | 13.5 | 14.7 | | dB |
| | 0.5 - 0.87 GHz | 12.7 | 14.2 | | dB |
| | 0.87 - 1.0 GHz | 12.1 | 13.4 | | dB |
| Gain Variation Over Temperature | 0.05 - 0.87 GHz | | 0.008 | | dB/ °C |
| Input Return Loss | 0.05 - 0.5 GHz | | 17 | | dB |
| | 0.5 - 0.87 GHz | | 10 | | dB |
| Output Return Loss | 0.05 - 0.5 GHz | | 10 | | dB |
| | 0.5 - 0.87 GHz | | 20 | | dB |
| Reverse Isolation | 0.05 - 0.87 GHz | | 23 | | dB |
| Output Power for 1 dB Compression (P1dB) | 0.05 - 0.87 GHz | 19.5 | 21 | | dBm |
| Output Third Order Intercept Point (IP3) (Pout= 0 dBm per tone, 1 MHz spacing) | 0.05 - 0.87 GHz | | 38 | | dBm |
| Output Second Order Intercept Point (IP2) | 0.05 - 0.5 GHz | | 78 | | dBm |
| Composite Second Order (CSO) [2] | 0.05 - 0.87 GHz | | -81 | | dBc |
| Composite Triple Beat (CTB) [2] | 0.05 - 0.87 GHz | | -75 | | dBc |
| Cross Modulation (XMOD) [2] | 0.05 - 0.87 GHz | | -67 | | dBc |
| Noise Figure | 0.05 - 0.5 GHz | | 5.5 | | dB |
| | 0.05 - 0.87 GHz | | 6.5 | | dB |
| Supply Current (Icc1 + Icc2) | | 145 | 160 | 175 | mA |

[1] Data taken with dual amplifiers combined in push-pull (default) configuration

[2] Input level +15 dBmV, 133 channels - with analog modulation



**GaAs HBT HIGH LINEARITY
PUSH-PULL AMPLIFIER, 75 Ohm, DC - 1 GHz**

Gain & Return Loss

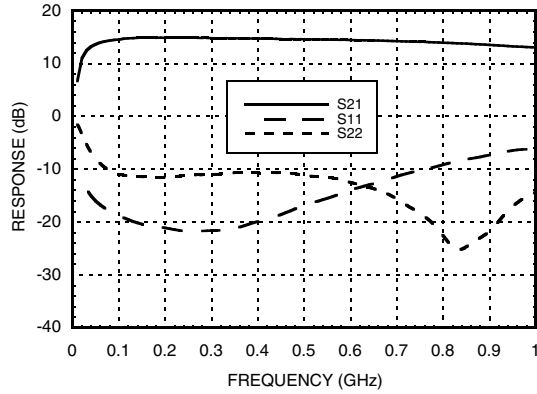

Gain vs. Temperature

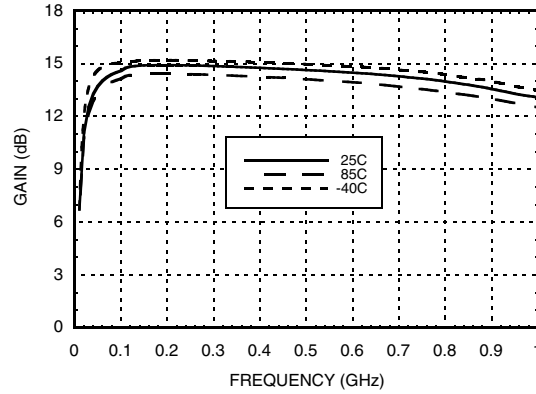

Input Return Loss vs. Temperature

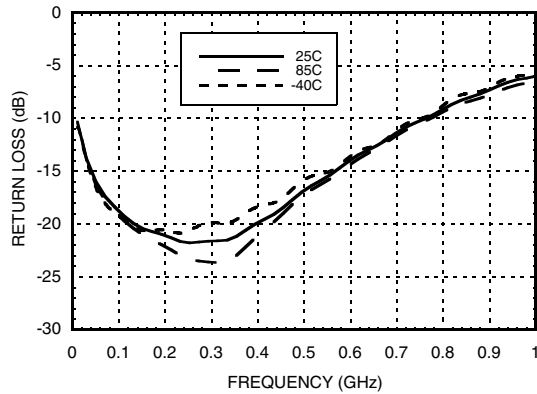

Output Return Loss vs. Temperature

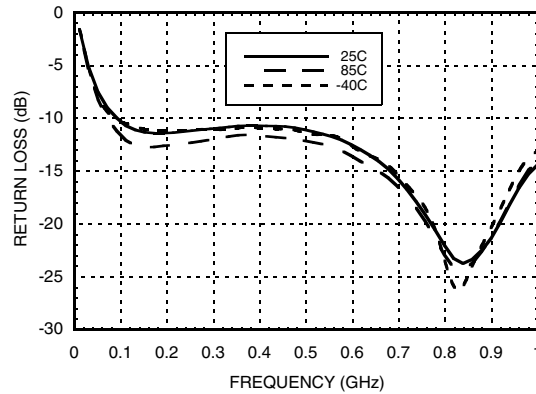

Output IP3 vs. Temperature

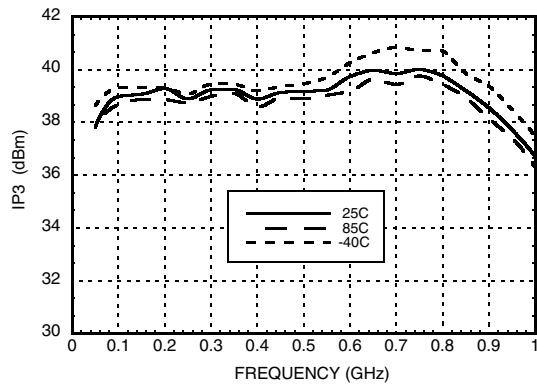

Output IP2 vs. Temperature

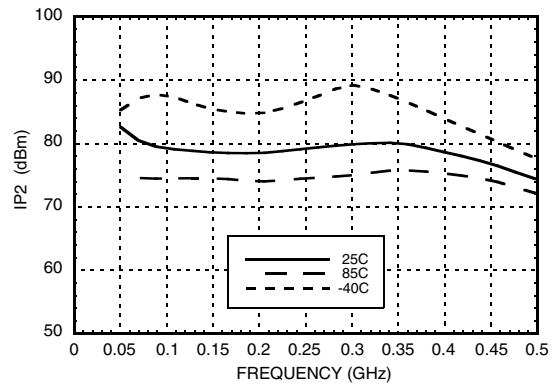



**GaAs HBT HIGH LINEARITY
PUSH-PULL AMPLIFIER, 75 Ohm, DC - 1 GHz**

8

AMPLIFIERS - DRIVER & GAIN BLOCK - SMT

Noise Figure vs. Temperature

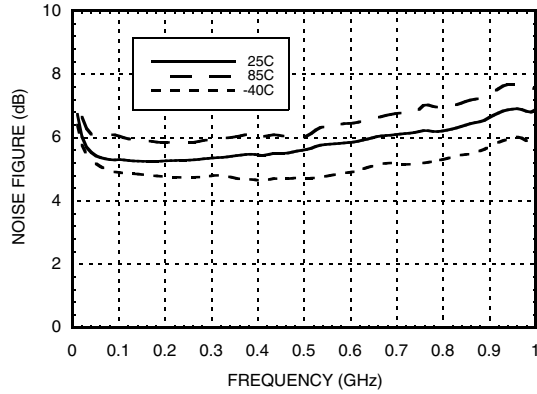

P1dB vs. Temperature

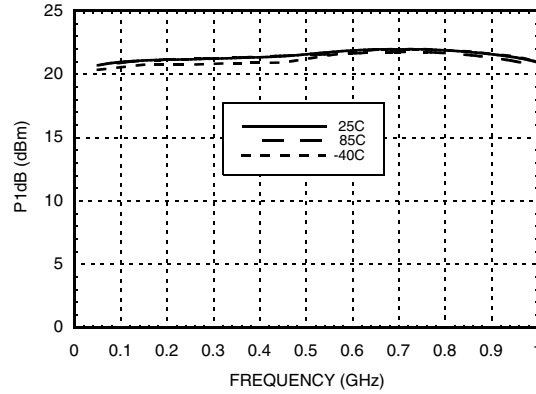

Reverse Isolation vs. Temperature

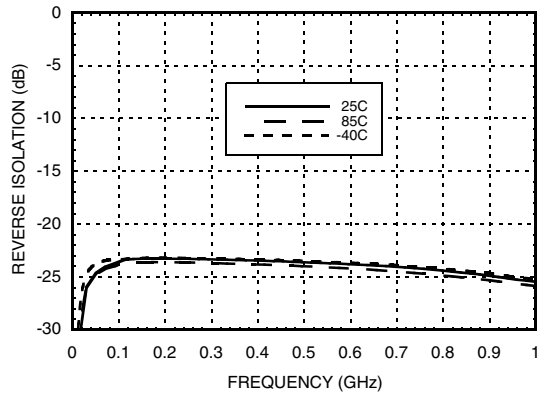

Output IP2 vs. Output Power

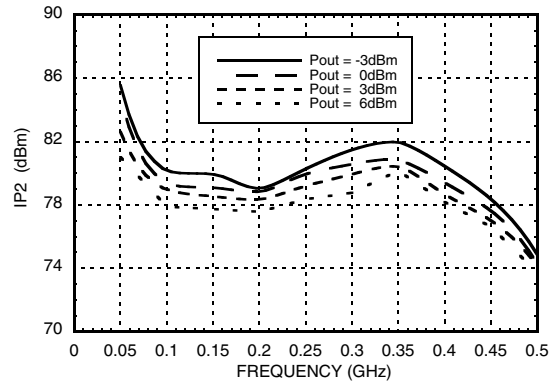

**CSO / CTB / XMOD
@ +15 dBmV input, 133 channels (Analog)**

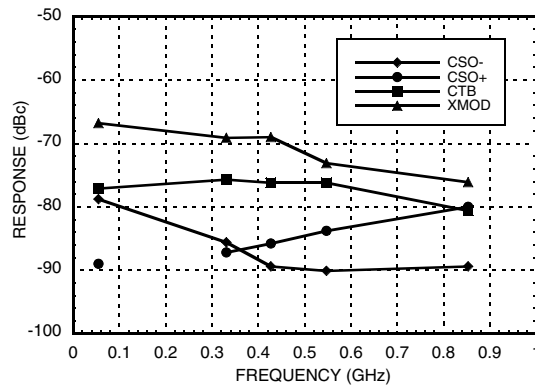



**GaAs HBT HIGH LINEARITY
PUSH-PULL AMPLIFIER, 75 Ohm, DC - 1 GHz**

Option 1 - Improved Input Return Loss & Gain Flatness (with Lower IP2) Application

Gain & Return Loss

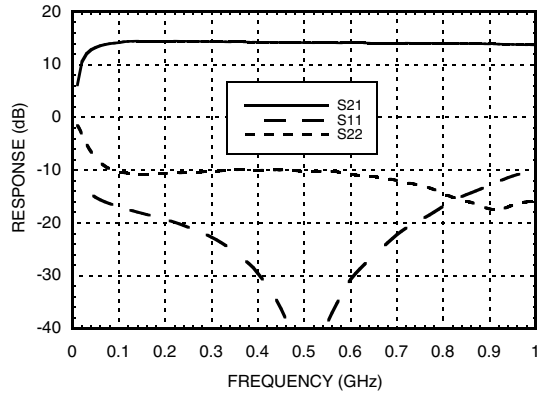

Output IP2 vs. Frequency

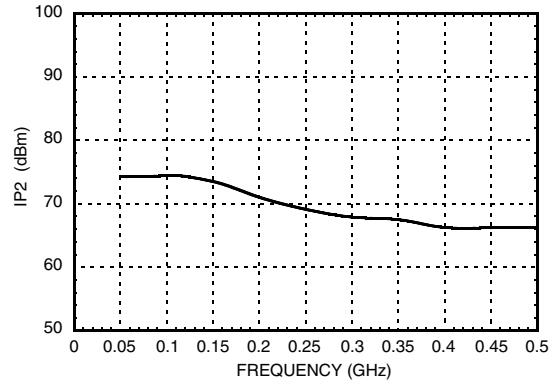

Output IP3 vs. Frequency

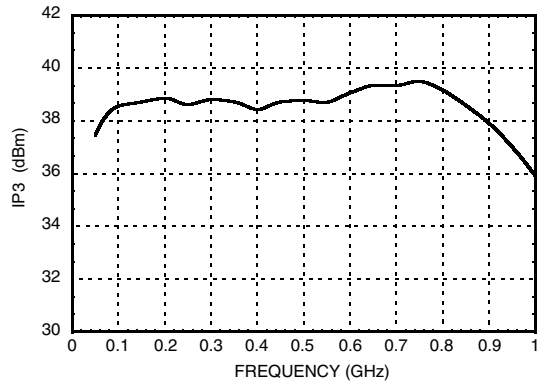

Noise Figure vs. Frequency

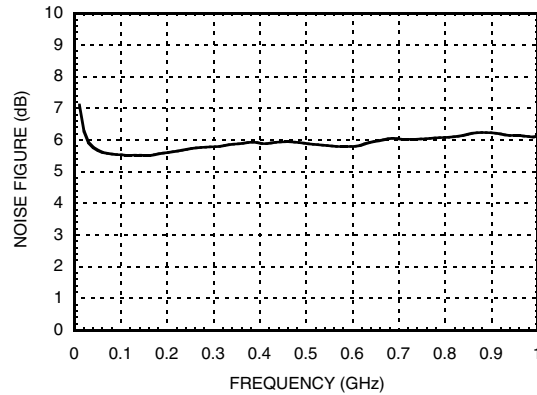

P1dB vs. Frequency

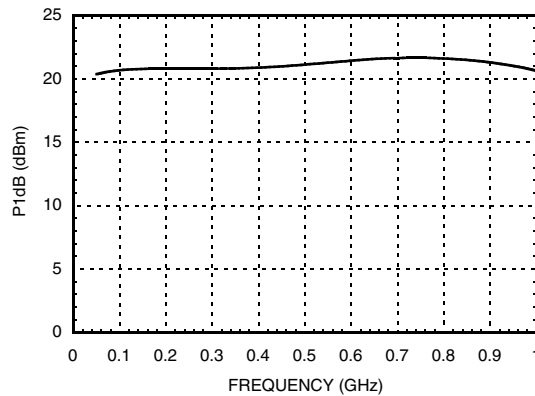



**GaAs HBT HIGH LINEARITY
PUSH-PULL AMPLIFIER, 75 Ohm, DC - 1 GHz**

Option 2 - 10 to 100 MHz Application

Gain & Return Loss

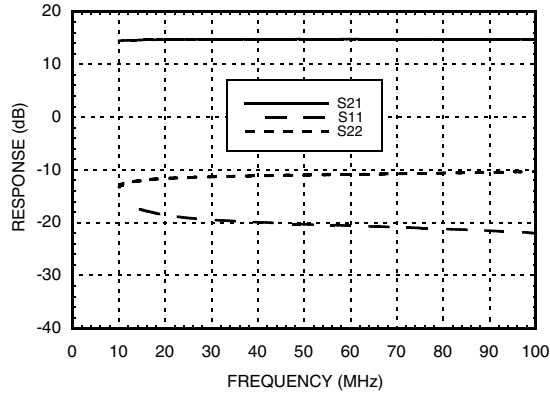

Output IP3 vs. Frequency

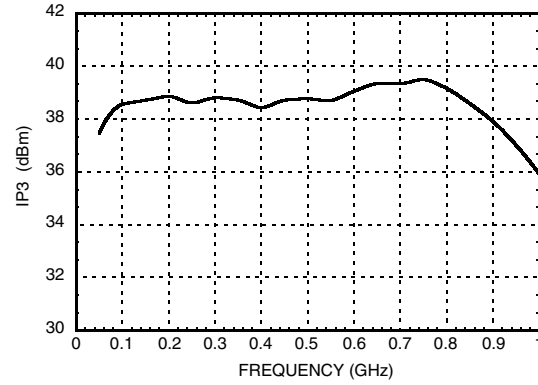

Noise Figure vs. Frequency

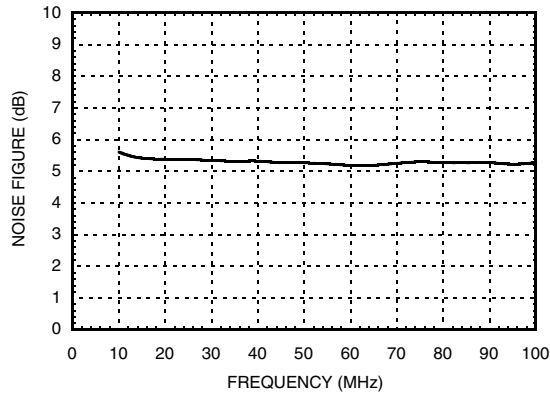

P1dB vs. Frequency

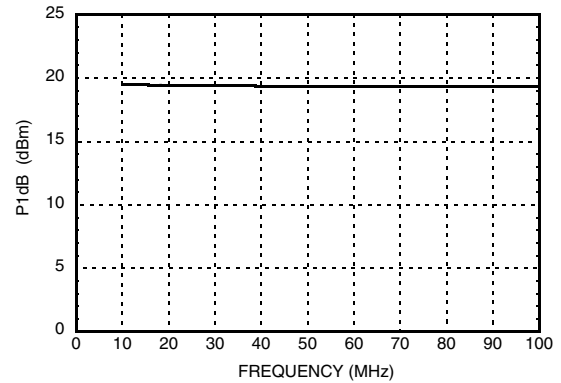



GaAs HBT HIGH LINEARITY PUSH-PULL AMPLIFIER, 75 Ohm, DC - 1 GHz

Absolute Maximum Ratings

| | |
|--|----------------|
| Collector Bias Voltage (Vcc) | +5.5 Vdc |
| RF Input Power (RFIN) | +10 dBm |
| Junction Temperature | 150 °C |
| Continuous P _{diss} (T = 85 °C) (derate 18.69 mW/°C above 85 °C) | 1.21 W |
| Thermal Resistance (junction to ground paddle) | 53.5 °C/W |
| Storage Temperature | -65 to +150 °C |
| Operating Temperature | -40 to +85 °C |
| ESD Sensitivity (HBM) | Class 1C |



ELECTROSTATIC SENSITIVE DEVICE
OBSERVE HANDLING PRECAUTIONS

Outline Drawing

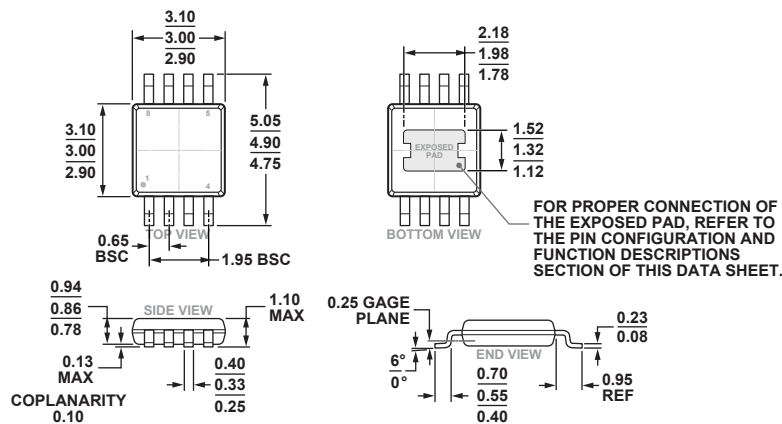

COMPLIANT TO JEDEC STANDARDS MO-187-AA-T

8-Lead Mini Small Outline Package with Exposed Pad [MINI_SO_EP]
(RH-8-3)
Dimensions shown in millimeters

Package Information



| Part Number | Package Body Material | Lead Finish | MSL Rating | Package Marking ^[3] |
|-----------------------|--|---------------|---------------------|--------------------------------|
| HMC754S8GE | RoHS-compliant Low Stress Injection Molded Plastic | 100% matte Sn | MSL1 ^[2] | HMC754 XXXX |
| HMC754S8GETR | RoHS-compliant Low Stress Injection Molded Plastic | 100% matte Sn | MSL1 ^[2] | HMC754 XXXX |
| 124063- HMC754S8GE | Eval Board | | | |
| 124825- HMC754S8GE | Eval Board | | | |
| 126311- HMC754S8GE | Eval Board | | | |

[1] Max peak reflow temperature of 235 °C
 [2] Max peak reflow temperature of 260 °C
 [3] 4-Digit lot number XXXX

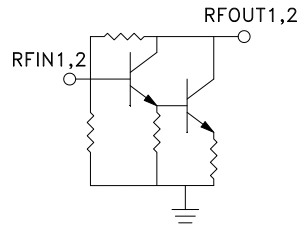

**GaAs HBT HIGH LINEARITY
PUSH-PULL AMPLIFIER, 75 Ohm, DC - 1 GHz**

Pin Descriptions

| Pin Number | Function | Description | Interface Schematic |
|------------|-----------------------------|---|---|
| 1, 4 | RFIN1, RFIN2 | These pins are DC coupled. An off chip DC block capacitor is required. |  |
| 5, 8 | RFOUT1/VCC1, RFOUT2/VCC2 | RF Output and DC bias for the output stage. | |
| 2 | GND | These pins and package bottom must be connected to RF/ DC ground. |  |
| 3, 6, 7 | N/C | No connection. These pins may be connected to RF ground. Performance will not be affected. | |



**GaAs HBT HIGH LINEARITY
PUSH-PULL AMPLIFIER, 75 Ohm, DC - 1 GHz**

Application Circuit for Push-Pull Operation

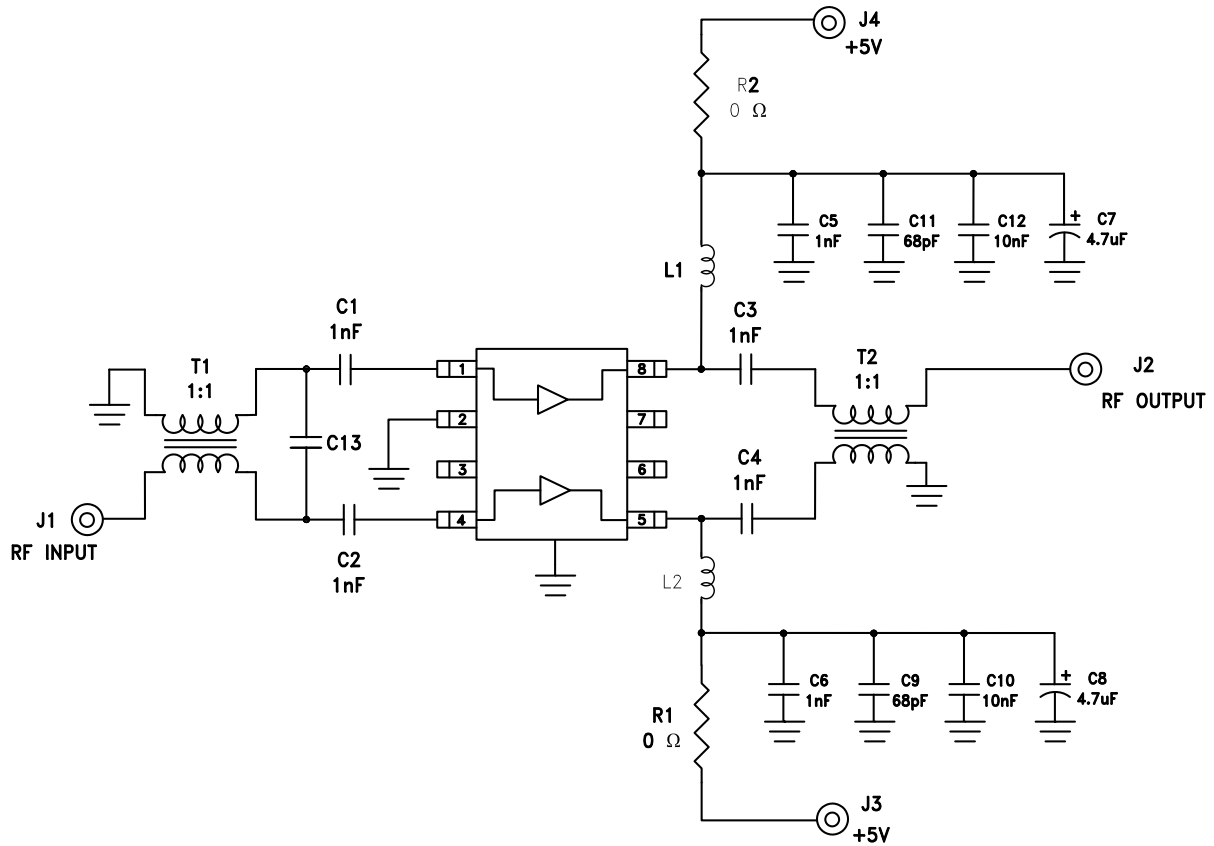

Components for Selected Options

| Tune Options | Standard | Option 1 | Option 2 |
|-----------------------|------------|------------|-------------|
| Evaluation PCB Number | 124063 | 126311 | 124825 |
| T1 [1] | ETC 1-1-13 | MABACT0039 | ETC1-1T-5TR |
| T2 [1] | ETC 1-1-13 | ETC 1-1-13 | ETC1-1T-5TR |
| L1, L2 | 180 nH | 180 nH | 10 uH |
| C13 | Open | 1.1 pF | Open |

[1] 1:1 Transformer



**GaAs HBT HIGH LINEARITY
PUSH-PULL AMPLIFIER, 75 Ohm, DC - 1 GHz**

Evaluation PCB - Standard and Option 2 Application

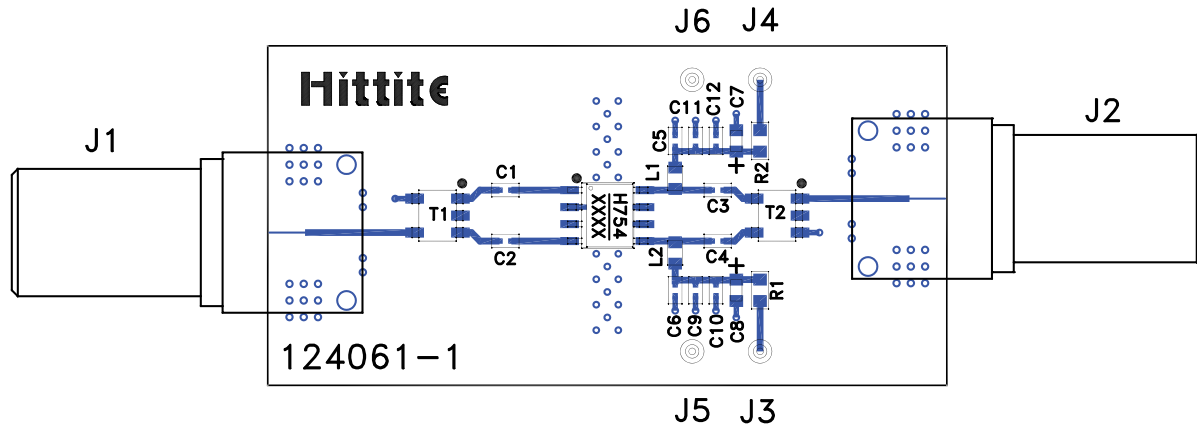

List of Materials for Evaluation PCB [1]

| Item | Description |
|------------|--|
| J1, J2 | F-Connector |
| J3 - J6 | DC PIN |
| C1 - C6 | 1 nF Capacitor, 0402 Pkg. |
| C7, C8 | 4.7 μ F Capacitor, Tantalum, 0603 Pkg. |
| C9, C11 | 68 pF Capacitor, 0402 Pkg. |
| C10, C12 | 10 nF Capacitor, 0402 Pkg. |
| L1, L2 [2] | Inductor, 0603 Pkg. |
| R1, R2 | 0 Ohm Resistor, 0603 Pkg. |
| T1, T2 [2] | 1:1 Transformer |
| U1 | HMC754S8GE Amplifier |
| PCB [3] | 124061 Evaluation PCB |

[1] When requesting an evaluation board, please reference the appropriate evaluation PCB number listed in the table "Components for Selected Options."

[2] Please refer to "Components for Selected Options" table for values

[3] Circuit Board Material: Rogers 4350 or Arlon 25FR

The circuit board used in the final application should use RF circuit design techniques. Signal lines should have 75 ohm impedance while the package ground leads and package bottom should be connected directly to the ground plane similar to that shown. A sufficient number of via holes should be used to connect the top and bottom ground planes. The evaluation board should be mounted to an appropriate heat sink. The evaluation circuit board shown is available from Analog Devices upon request.



Evaluation PCB - Option 1 Application

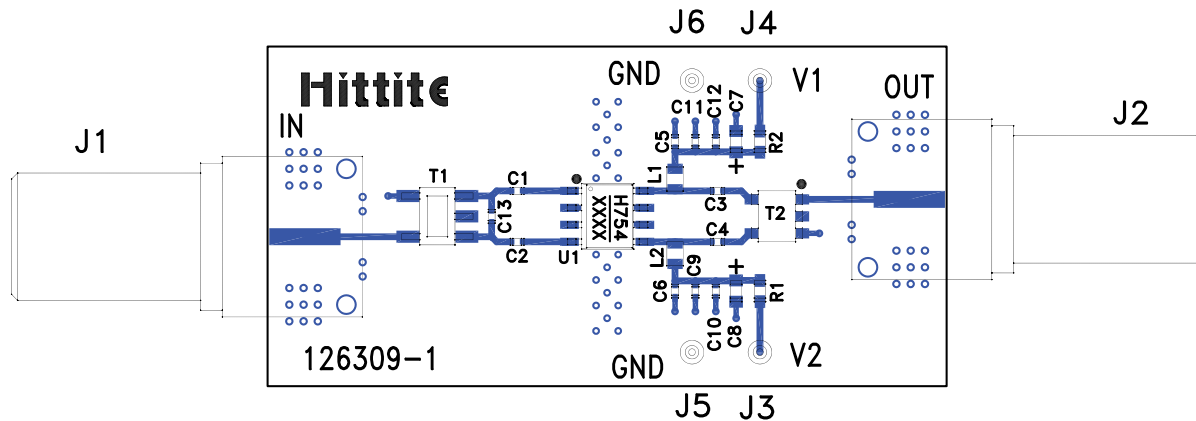

List of Materials for Evaluation PCB [1]

| Item | Description |
|------------|--|
| J1, J2 | F-Connector |
| J3 - J6 | DC PIN |
| C1 - C6 | 1 nF Capacitor, 0402 Pkg. |
| C7, C8 | 4.7 μ F Capacitor, Tantalum, 0603 Pkg. |
| C9, C11 | 68 pF Capacitor, 0402 Pkg. |
| C10, C12 | 10 nF Capacitor, 0402 Pkg. |
| C13 | 1.1 pF Capacitor, 0402 Pkg. |
| L1, L2 | 180 nH Inductor, 0603 Pkg. |
| R1, R2 | 0 Ohm Resistor, 0603 Pkg. |
| T1, T2 [2] | 1:1 Transformer |
| U1 | HMC754S8GE Amplifier |
| PCB [3] | 126309 Evaluation PCB |

[1] When requesting an evaluation board, please reference the appropriate evaluation PCB number listed in the table "Components for Selected Options."

[2] Please refer to "Components for Selected Options" table for values

[3] Circuit Board Material: Rogers 4350 or Arlon 25FR

The circuit board used in the final application should use RF circuit design techniques. Signal lines should have 75 ohm impedance while the package ground leads and package bottom should be connected directly to the ground plane similar to that shown. A sufficient number of via holes should be used to connect the top and bottom ground planes. The evaluation board should be mounted to an appropriate heat sink. The evaluation circuit board shown is available from Analog Devices upon request.

Компания «Океан Электроники» предлагает заключение долгосрочных отношений при поставках импортных электронных компонентов на взаимовыгодных условиях!

Наши преимущества:

- Поставка оригинальных импортных электронных компонентов напрямую с производств Америки, Европы и Азии, а так же с крупнейших складов мира;
- Широкая линейка поставок активных и пассивных импортных электронных компонентов (более 30 млн. наименований);
- Поставка сложных, дефицитных, либо снятых с производства позиций;
- Оперативные сроки поставки под заказ (от 5 рабочих дней);
- Экспресс доставка в любую точку России;
- Помощь Конструкторского Отдела и консультации квалифицированных инженеров;
- Техническая поддержка проекта, помощь в подборе аналогов, поставка прототипов;
- Поставка электронных компонентов под контролем ВП;
- Система менеджмента качества сертифицирована по Международному стандарту ISO 9001;
- При необходимости вся продукция военного и аэрокосмического назначения проходит испытания и сертификацию в лаборатории (по согласованию с заказчиком);
- Поставка специализированных компонентов военного и аэрокосмического уровня качества (Xilinx, Altera, Analog Devices, Intersil, Interpoint, Microsemi, Actel, Aeroflex, Peregrine, VPT, Syfer, Eurofarad, Texas Instruments, MS Kennedy, Miteq, Cobham, E2V, MA-COM, Hittite, Mini-Circuits, General Dynamics и др.);

Компания «Океан Электроники» является официальным дистрибьютором и эксклюзивным представителем в России одного из крупнейших производителей разъемов военного и аэрокосмического назначения «JONHON», а так же официальным дистрибьютором и эксклюзивным представителем в России производителя высокотехнологичных и надежных решений для передачи СВЧ сигналов «FORSTAR».



JONHON

«JONHON» (основан в 1970 г.)

Разъемы специального, военного и аэрокосмического назначения:

(Применяются в военной, авиационной, аэрокосмической, морской, железнодорожной, горно- и нефтедобывающей отраслях промышленности)

«FORSTAR» (основан в 1998 г.)

ВЧ соединители, коаксиальные кабели, кабельные сборки и микроволновые компоненты:

(Применяются в телекоммуникациях гражданского и специального назначения, в средствах связи, РЛС, а так же военной, авиационной и аэрокосмической отраслях промышленности).



Телефон: 8 (812) 309-75-97 (многоканальный)

Факс: 8 (812) 320-03-32

Электронная почта: ocean@oceanchips.ru

Web: <http://oceanchips.ru/>

Адрес: 198099, г. Санкт-Петербург, ул. Калинина, д. 2, корп. 4, лит. А