

MAXIM

825MHz to 915MHz, Dual SiGe High-Linearity Active Mixer

MAX9981

General Description

The MAX9981 dual high-linearity mixer integrates a local oscillator (LO) switch, LO buffer, LO splitter, and two active mixers. On-chip baluns allow for single-ended RF and LO inputs. The active mixers eliminate the need for an additional IF amplifier because the mixer provides a typical overall conversion gain of 2.1dB.

The MAX9981 active mixers are optimized to meet the demanding requirements of GSM850, GSM900, and CDMA850 base-station receivers. These mixers provide exceptional linearity with an input IP3 of greater than +27dBm. The integrated LO driver allows for a wide range of LO drive levels from -5dBm to +5dBm. In addition, the built-in high-isolation switch enables rapid LO selection of less than 250ns, as needed for GSM transceiver designs.

The MAX9981 is available in a 36-pin QFN package (6mm x 6mm) with an exposed paddle, and is specified over the -40°C to +85°C extended temperature range.

Applications

GSM850/GSM900 2G and 2.5G EDGE Base-Station Receivers

Cellular cdmaOne™ and cdma2000™ Base-Station Receivers

TDMA and Integrated Digital Enhanced Network (iDEN)™ Base-Station Receivers

Digital and Spread-Spectrum Communication Systems

Microwave Point-to-Point Links

cdmaOne is a trademark of CDMA Development Group.

cdma2000 is a trademark of Telecommunications Industry Association.

iDEN is a trademark of Motorola, Inc.

Features

- ◆ +27.3dBm Input IP3
- ◆ +13.6dBm Input 1dB Compression Point
- ◆ 825MHz to 915MHz RF Frequency Range
- ◆ 70MHz to 170MHz IF Frequency Range
- ◆ 725MHz to 1085MHz LO Frequency Range
- ◆ 2.1dB Conversion Gain
- ◆ 10.8dB Noise Figure
- ◆ 42dB Channel-to-Channel Isolation
- ◆ -5dBm to +5dBm LO Drive
- ◆ +5V Single-Supply Operation
- ◆ Built-In LO Switch with 52dB LO1 to LO2 Isolation
- ◆ ESD Protection
- ◆ Integrated RF and LO Baluns for Single-Ended Inputs

Ordering Information

PART	TEMP RANGE	PIN-PACKAGE
MAX9981EGX-T	-40°C to +85°C	36 QFN-EP* (6mm x 6mm)

*EP = Exposed paddle.

Pin Configuration/ Functional Diagram

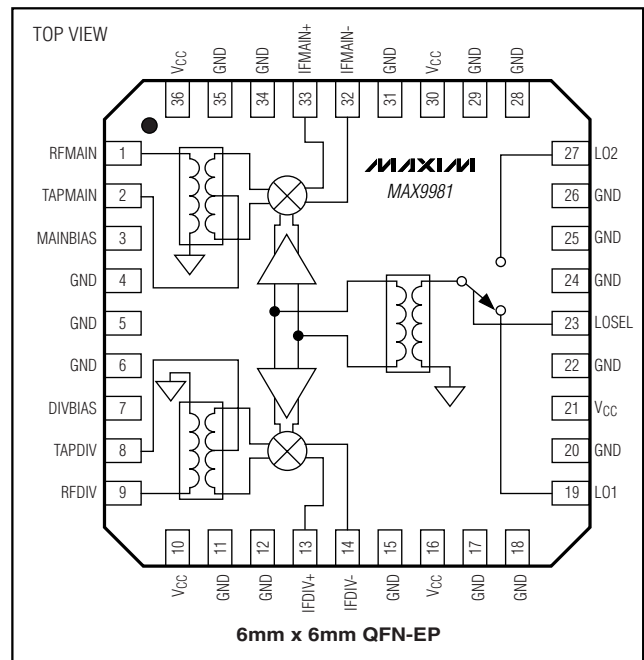
**MAXIM**

Maxim Integrated Products 1

For pricing, delivery, and ordering information, please contact Maxim/Dallas Direct! at 1-888-629-4642, or visit Maxim's website at www.maxim-ic.com.

825MHz to 915MHz, Dual SiGe High-Linearity Active Mixer

ABSOLUTE MAXIMUM RATINGS

V _{CC}	-0.3V to +5.5V	Continuous Power Dissipation (T _A = +70°C)	
IFMAIN+, IFMAIN-, IFDIV+, IFDIV-, MAINBIAS, DIVBIAS, LOSEL.....	-0.3V to (V _{CC} + 0.3V)	36-Pin QFN (derate 33mW/°C above +70°C).....	2200mW
TAPMAIN, TAPDIV.....	+5.5V	Operating Temperature Range	-40°C to +85°C
MAINBIAS, DIVBIAS Current	5mA	Junction Temperature	+150°C
RFMAIN, RFDIV, LO1, LO2 Input Power	+20dBm	Storage Temperature Range	-65°C to +150°C
		Lead Temperature (soldering, 10s)	+300°C

Stresses beyond those listed under "Absolute Maximum Ratings" may cause permanent damage to the device. These are stress ratings only, and functional operation of the device at these or any other conditions beyond those indicated in the operational sections of the specifications is not implied. Exposure to absolute maximum rating conditions for extended periods may affect device reliability.

DC ELECTRICAL CHARACTERISTICS

(Typical Application Circuit, V_{CC} = +4.75V to +5.25V, no RF signals applied, all RF inputs and outputs terminated with 50Ω, 267Ω resistors connected from MAINBIAS and DIVBIAS to GND, T_A = -40°C to +85°C, unless otherwise noted. Typical values are at V_{CC} = +5.0V, T_A = +25°C, unless otherwise noted.)

PARAMETER	SYMBOL	CONDITIONS	MIN	TYP	MAX	UNITS
Supply Voltage	V _{CC}		4.75	5.00	5.25	V
Supply Current	I _{CC}		260	291	325	mA
Input High Voltage	V _{IH}		3.5			V
Input Low Voltage	V _{IL}				0.4	V
LOSEL Input Current	I _{LOSEL}		-5		+5	μA

AC ELECTRICAL CHARACTERISTICS

(Typical Application Circuit, V_{CC} = +4.75V to +5.25V, P_{LO} = -5dBm to +5dBm, f_{RF} = 825MHz to 915MHz, f_{LO} = 725MHz to 1085MHz, T_A = -40°C to +85°C, unless otherwise noted. Typical values are at V_{CC} = +5.0V, P_{RF} = -5dBm, P_{LO} = 0dBm, f_{RF} = 870MHz, f_{LO} = 770MHz, T_A = +25°C, unless otherwise noted.) (Notes 1, 2)

PARAMETER	SYMBOL	CONDITIONS	MIN	TYP	MAX	UNITS
RF Frequency	f _{RF}		825		915	MHz
LO Frequency	f _{LO}		725		1085	MHz
IF Frequency	f _{IF}	Must meet RF and LO frequency range. IF matching components affect IF frequency range.	70		170	MHz
LO Drive Level	P _{LO}		-5		+5	dBm
Conversion Gain (Note 3)	G _C	V _{CC} = +5.0V, f _{IF} = 100MHz, low-side injection, P _{RF} = 0dBm, P _{LO} = -5dBm	Cellular band, f _{RF} = 825MHz to 850MHz	2.7		dB
			GSM band, f _{RF} = 880MHz to 915MHz	2.1		
Gain Variation from Nominal		f _{RF} = 825MHz to 915MHz, 3σ		±0.6		dB
Conversion Loss from LO to IF		Inject P _{IN} = -20dBm at f _{LO} + 100MHz into LO port. Measure 100MHz at IF port as P _{OUT} . No RF signal at RF port.		53		dB
Noise Figure	NF	100MHz IF, low-side injection	Cellular band, f _{RF} = 825MHz to 850MHz	10.8		dB
			GSM band, f _{RF} = 880MHz to 915MHz	11.9		

825MHz to 915MHz, Dual SiGe High-Linearity Active Mixer

MAX9981

AC ELECTRICAL CHARACTERISTICS (continued)

(Typical Application Circuit, $V_{CC} = +4.75V$ to $+5.25V$, $P_{LO} = -5dBm$ to $+5dBm$, $f_{RF} = 825MHz$ to $915MHz$, $f_{LO} = 725MHz$ to $1085MHz$, $T_A = -40^{\circ}C$ to $+85^{\circ}C$, unless otherwise noted. Typical values are at $V_{CC} = +5.0V$, $P_{RF} = -5dBm$, $P_{LO} = 0dBm$, $f_{RF} = 870MHz$, $f_{LO} = 770MHz$, $T_A = +25^{\circ}C$, unless otherwise noted.) (Notes 1, 2)

PARAMETER	SYMBOL	CONDITIONS		MIN	TYP	MAX	UNITS
Input 1dB Compression Point	P_{1dB}	Low-side injection			13.6		dBm
Input Third-Order Intercept Point	IIP3	$P_{LO} = -5dBm$ to $+5dBm$ (Notes 3, 4)			27.3		dBm
2 RF - 2 LO Spur Rejection	2×2	$f_{RF} = 915MHz$, $f_{LO} = 815MHz$, $f_{SPUR} = 865MHz$, $P_{RF} = -5dBm$	Main		53.3		dBc
			Diversity		43.2		
3 RF - 3 LO Spur Rejection	3×3	$f_{RF} = 915MHz$, $f_{LO} = 815MHz$, $f_{SPUR} = 848.3MHz$, $P_{RF} = -5dBm$			79.7		dBc
Maximum LO Leakage at RF Port		$P_{LO} = -5dBm$ to $+5dBm$, $f_{LO} = 725MHz$ to $1100MHz$			-42		dBm
Maximum LO Leakage at IF Port		$P_{LO} = -5dBm$ to $+5dBm$, $f_{LO} = 725MHz$ to $1100MHz$			-30.6		dBm
Minimum RF to IF Isolation		$P_{LO} = -5dBm$ to $+5dBm$, $f_{RF} = 825MHz$ to $915MHz$			18		dB
LO1 to LO2 Isolation		$f_{RF} = 825MHz$ to $915MHz$, $P_{LO1} = P_{LO2} =$ $+5dBm$, $f_{IF} = 100MHz$ (Note 5)			52		dB
Minimum Channel Isolation		$f_{RF} = 825MHz$ to $915MHz$, $f_{LO} = 725MHz$ to $1085MHz$	$P_{RFMAIN} = -5dBm$, R_{FDIV} terminated with 50Ω . Measured power at $IFDIV$ relative to $IFMAIN$.		39.5		dBc
			$P_{RFDIV} = -5dBm$, R_{FMAIN} terminated with 50Ω . Measured power at $IFMAIN$ relative to $IFDIV$.		42		
LO Switching Time		50% of LOSEL to IF settled within 2°			250		ns
RF Return Loss					25		dB
LO Return Loss		LO port selected			19		dB
		LO port unselected			14.3		
IF Return Loss		RF and LO terminated into 50Ω , $f_{IF} = 100MHz$ (Note 6)			15		dB

Note 1: Guaranteed by design and characterization.

Note 2: All limits reflect losses of external components. Output measurements taken at IF OUT of Typical Application Circuit.

Note 3: Production tested.

Note 4: Two tones at 1MHz spacing, -5dBm per tone at RF port.

Note 5: Measured at IF port at IF frequency. f_{LO1} and f_{LO2} are offset by 1MHz.

Note 6: IF return loss can be optimized by external matching components.

825MHz to 915MHz, Dual SiGe High-Linearity Active Mixer

Typical Operating Characteristics

(Typical Application Circuit, $V_{CC} = 5.0V$, $P_{RF} = -5dBm$, $P_{LO} = 0dBm$, $T_A = +25^\circ C$, unless otherwise noted.)

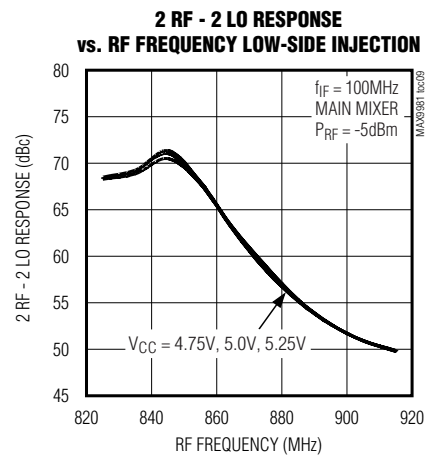
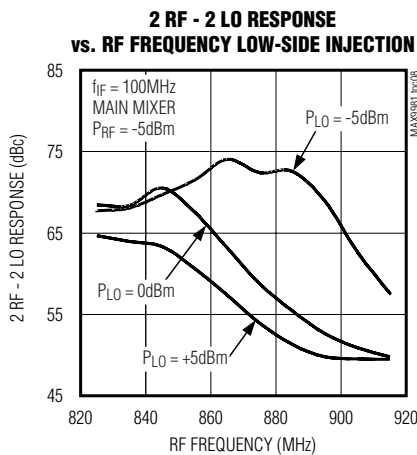
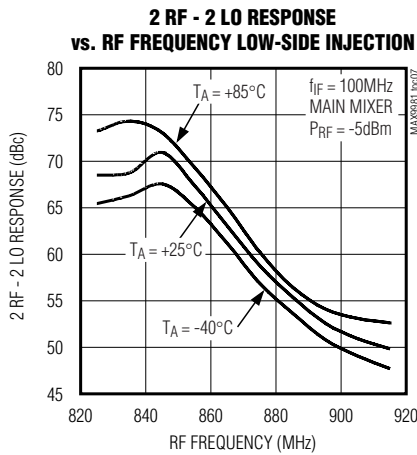
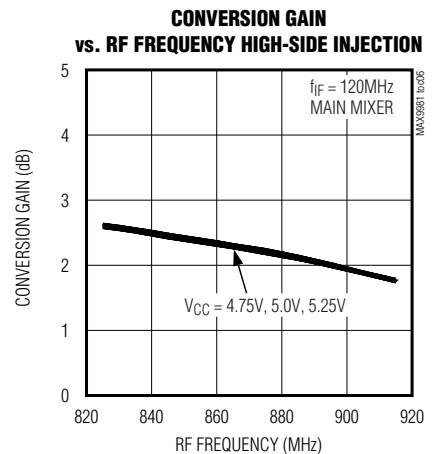
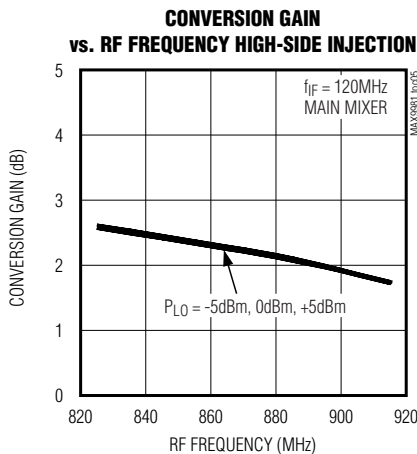
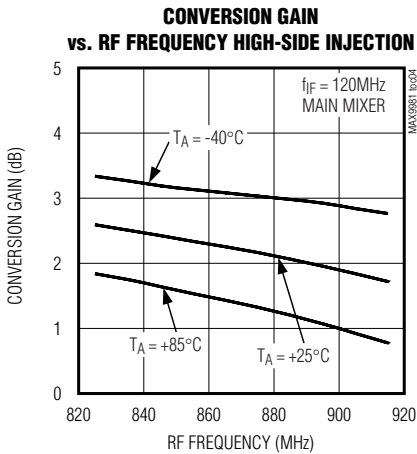
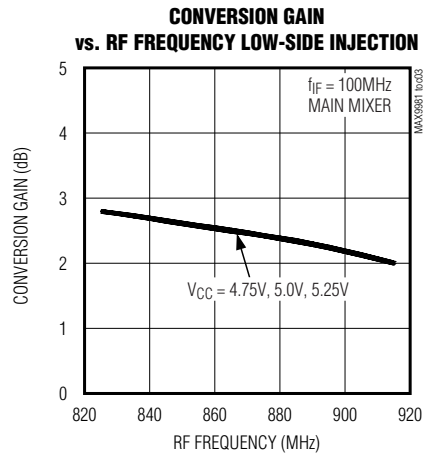
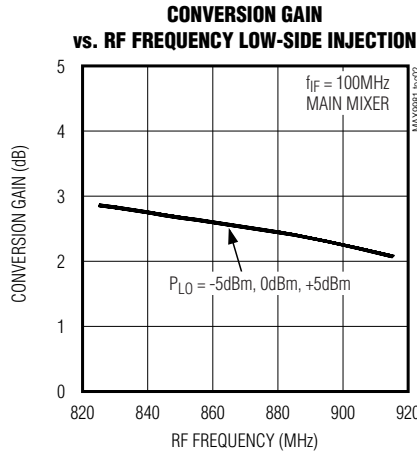
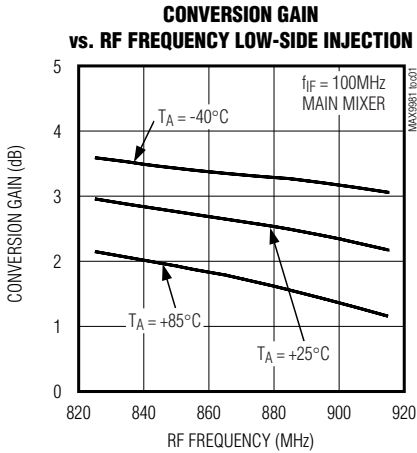

825MHz to 915MHz, Dual SiGe High-Linearity Active Mixer

MAX9981

Typical Operating Characteristics (continued)

(Typical Application Circuit, $V_{CC} = 5.0V$, $P_{RF} = -5dBm$, $P_{LO} = 0dBm$, $T_A = +25^\circ C$, unless otherwise noted.)

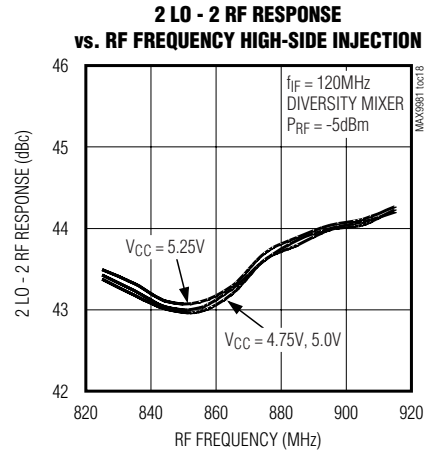
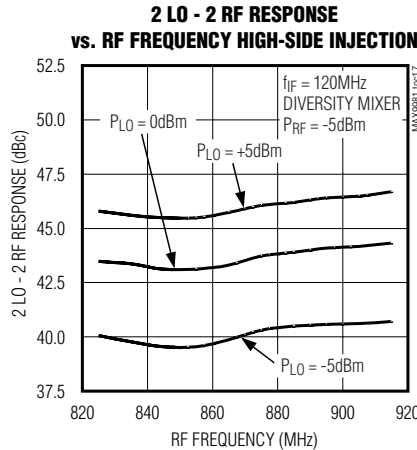
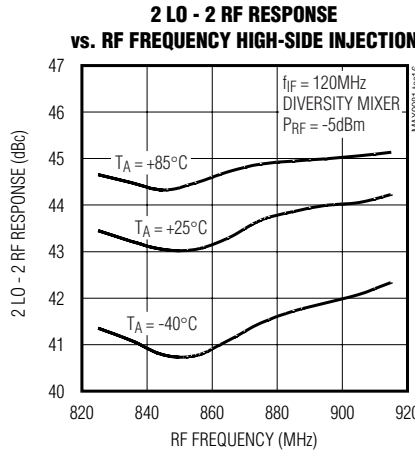
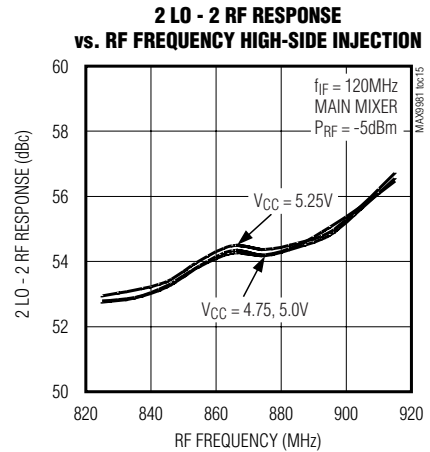
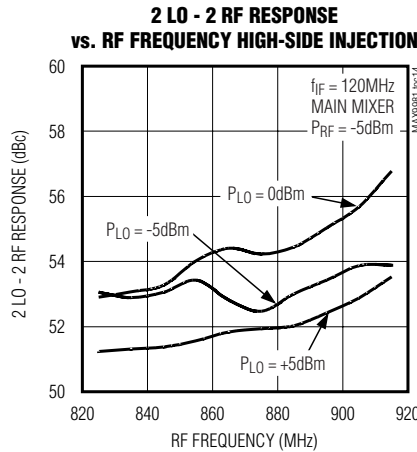
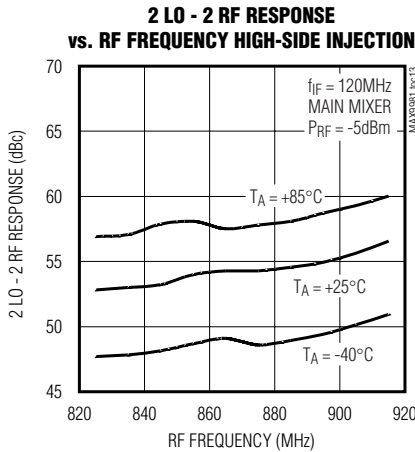
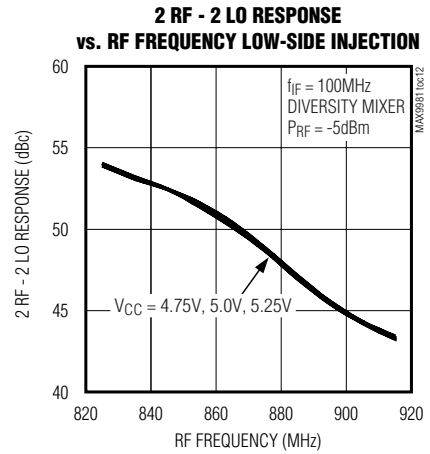
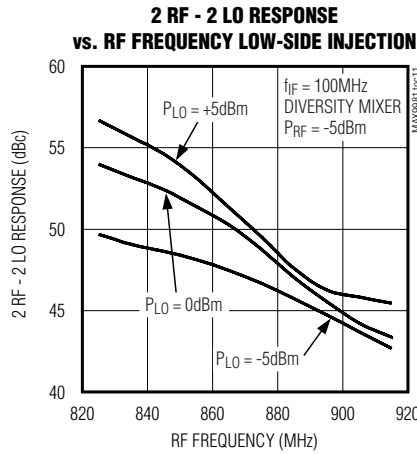
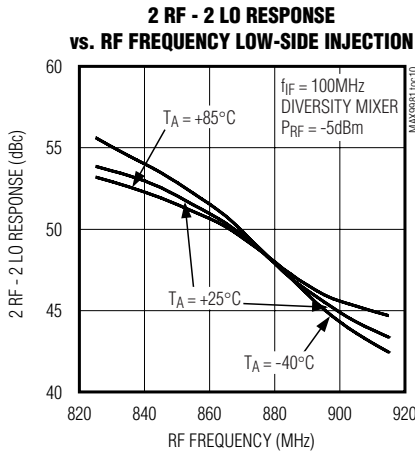

825MHz to 915MHz, Dual SiGe High-Linearity Active Mixer

Typical Operating Characteristics (continued)

(Typical Application Circuit, $V_{CC} = 5.0V$, $P_{RF} = -5dBm$, $P_{LO} = 0dBm$, $T_A = +25^\circ C$, unless otherwise noted.)

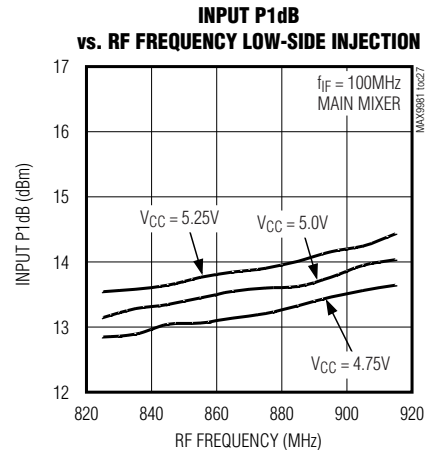
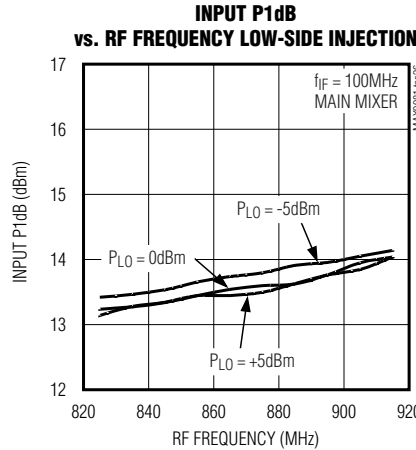
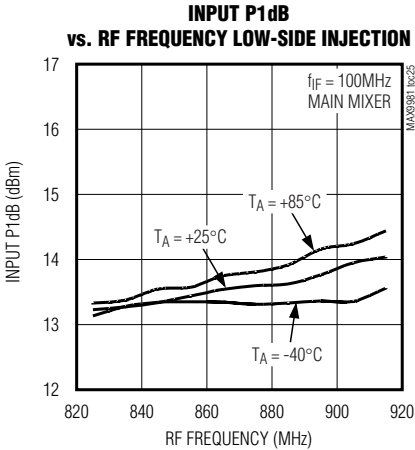
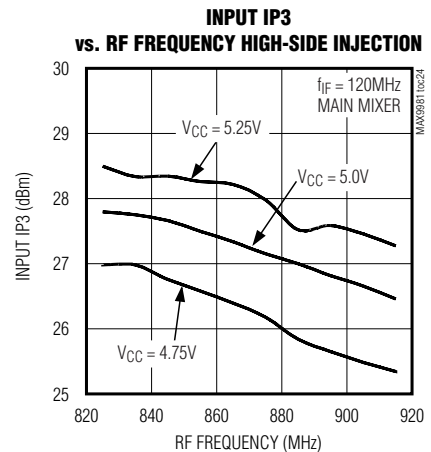
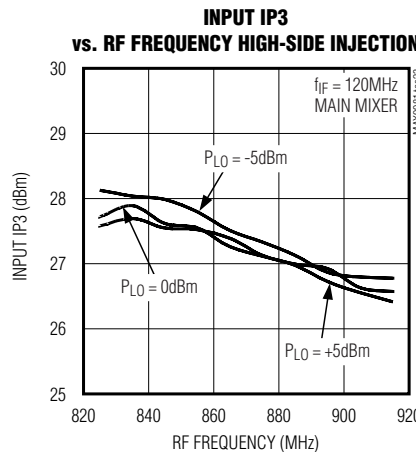
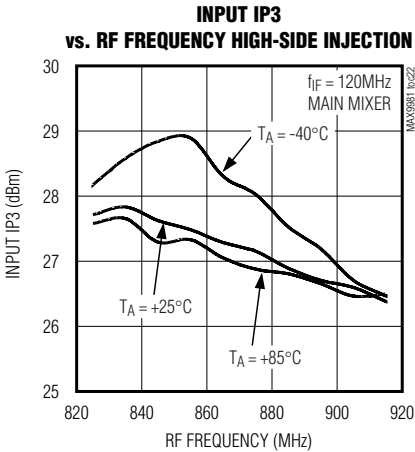
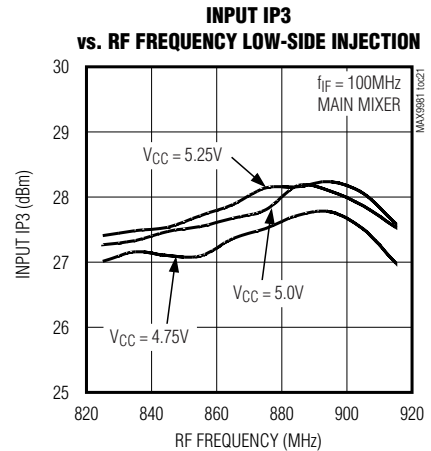
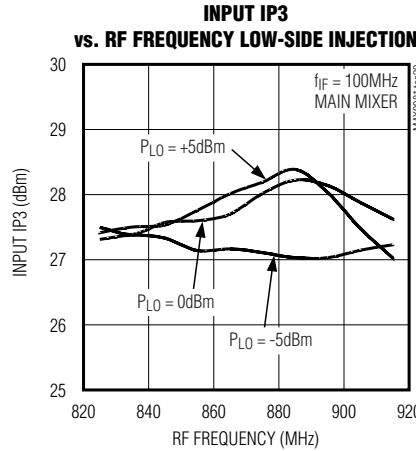
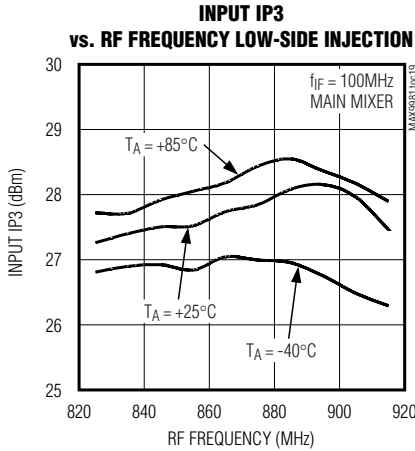

825MHz to 915MHz, Dual SiGe High-Linearity Active Mixer

Typical Operating Characteristics (continued)

(Typical Application Circuit, $V_{CC} = 5.0V$, $P_{RF} = -5dBm$, $P_{LO} = 0dBm$, $T_A = +25^\circ C$, unless otherwise noted.)

MAX9981

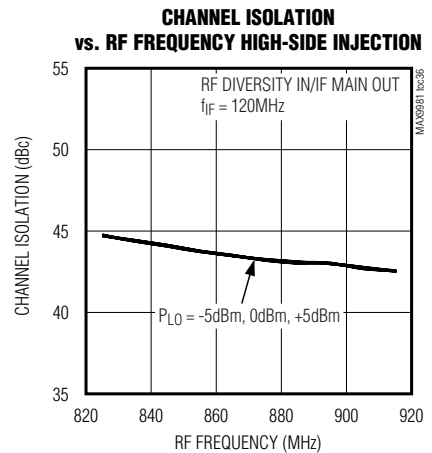
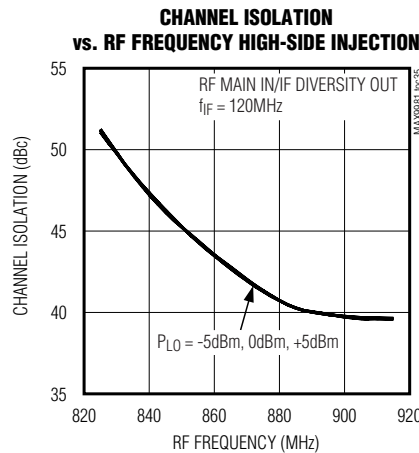
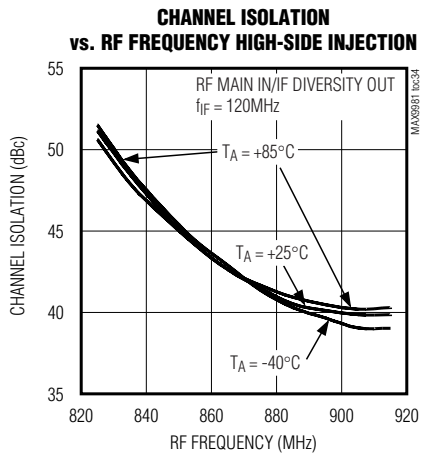
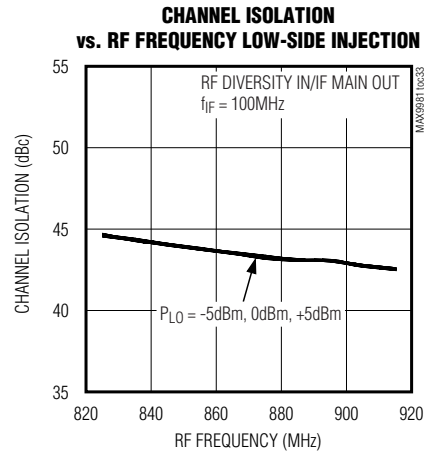
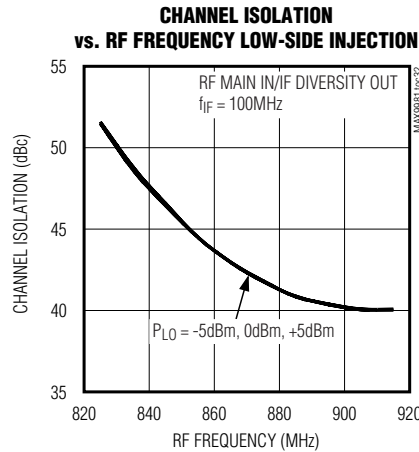
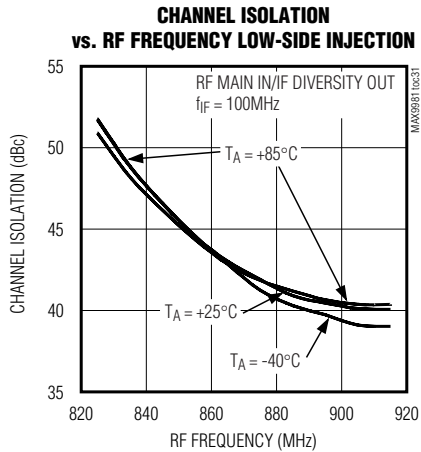
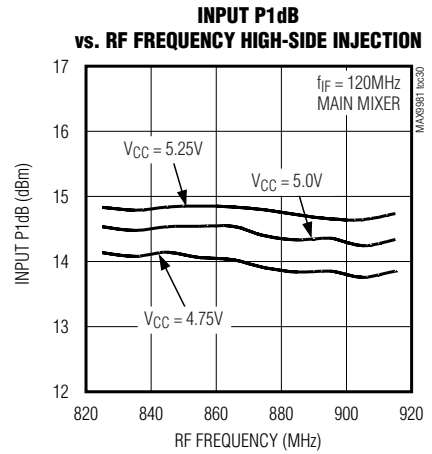
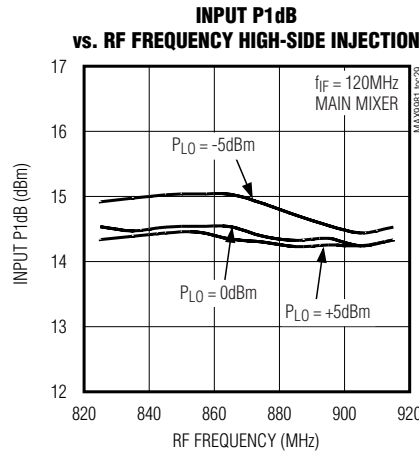
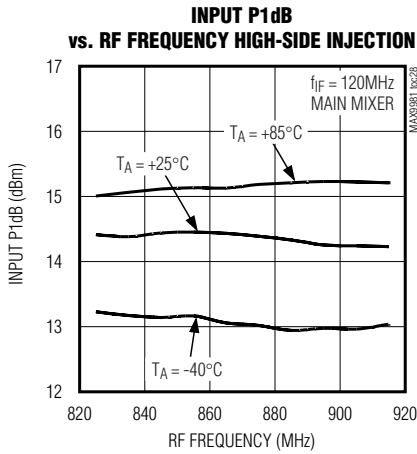

825MHz to 915MHz, Dual SiGe High-Linearity Active Mixer

Typical Operating Characteristics (continued)

(Typical Application Circuit, $V_{CC} = 5.0V$, $P_{RF} = -5dBm$, $P_{LO} = 0dBm$, $T_A = +25^\circ C$, unless otherwise noted.)

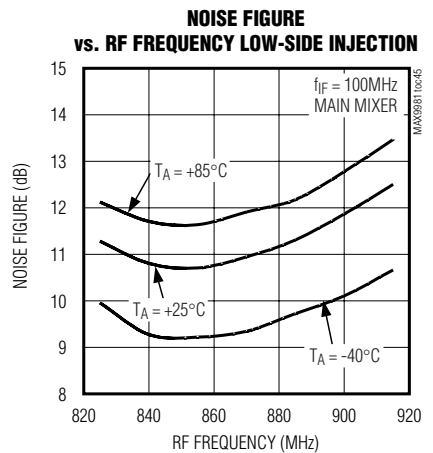
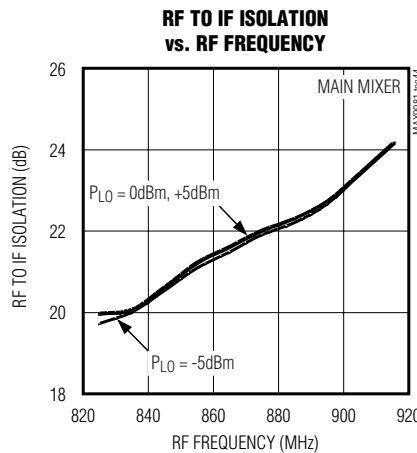
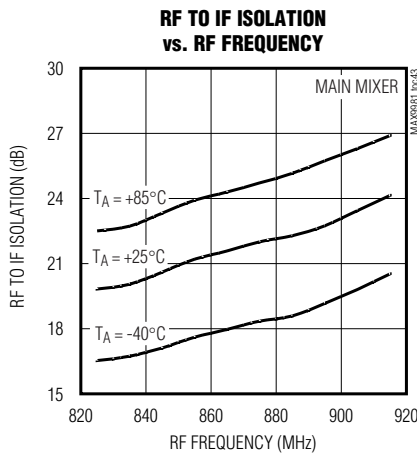
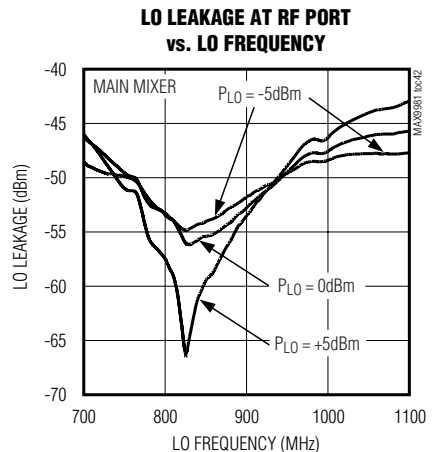
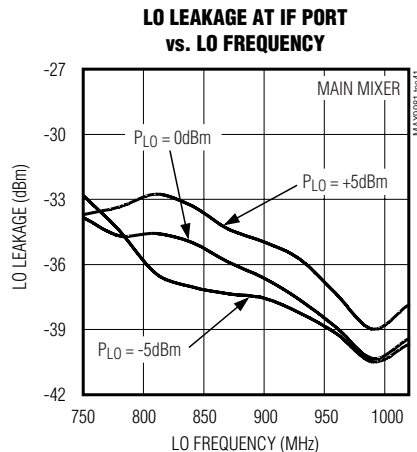
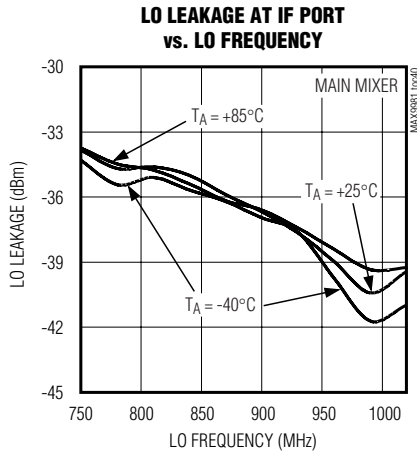
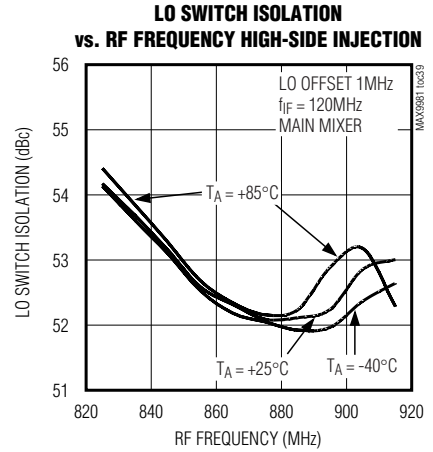
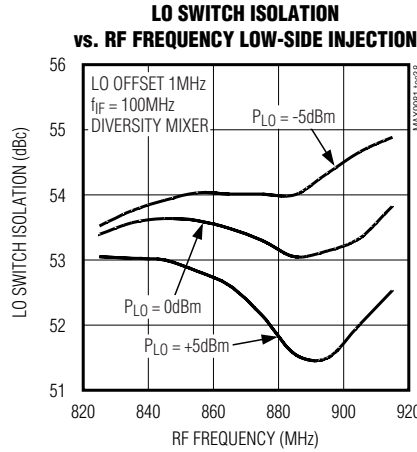
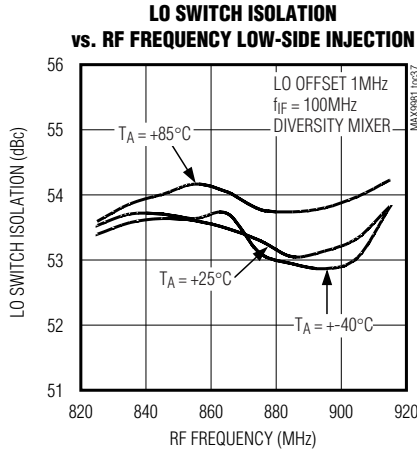

825MHz to 915MHz, Dual SiGe High-Linearity Active Mixer

MAX9981

Typical Operating Characteristics (continued)

(Typical Application Circuit, $V_{CC} = 5.0V$, $P_{RF} = -5dBm$, $P_{LO} = 0dBm$, $T_A = +25^\circ C$, unless otherwise noted.)

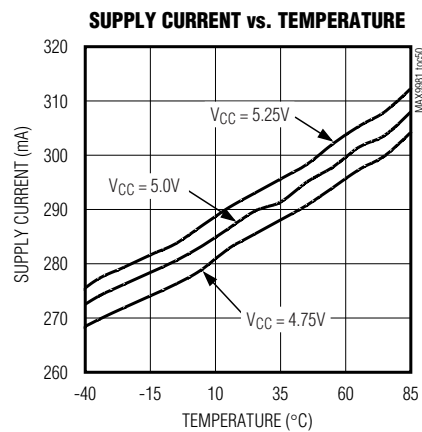
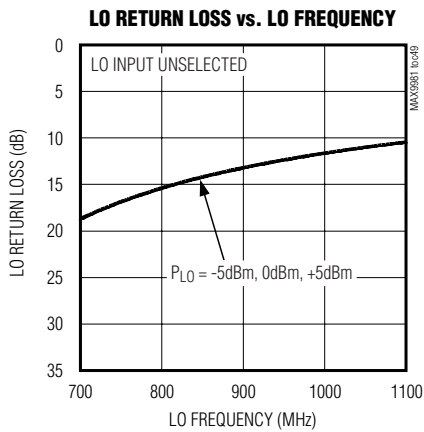
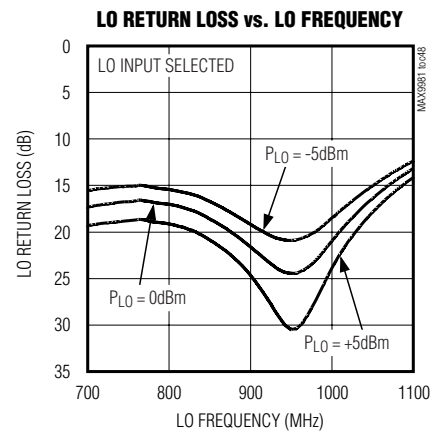
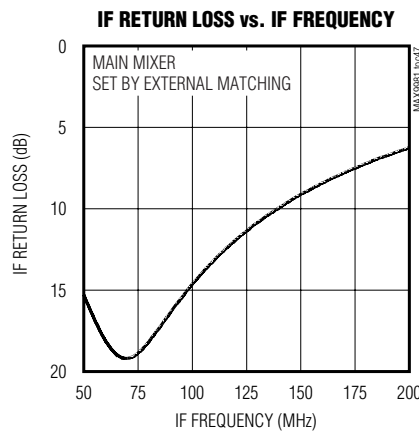
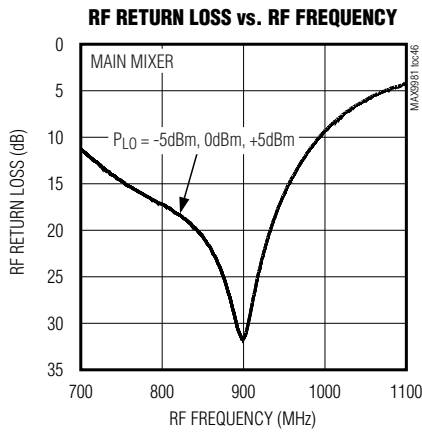

825MHz to 915MHz, Dual SiGe High-Linearity Active Mixer

Pin Description

PIN	NAME	FUNCTION
1	RFMAIN	Main Channel RF Input. This input is internally matched to 50Ω and is DC shorted to ground through a balun.
2	TAPMAIN	Main RF Balun Center Tap. Connect bypass capacitors from this pin to ground.
3	MAINBIAS	Bias control for the Main Mixer. Connect a 267Ω resistor from this pin to ground to set the bias current for the main mixer.
4, 5, 6, 11, 12, 15, 17, 18, 20, 22, 24, 25, 26, 28, 29, 31, 34, 35, EP	GND	Ground
7	DIVBIAS	Bias Control for the Diversity Mixer. Connect a 267Ω resistor from this pin to ground to set the bias current for the diversity mixer.
8	TAPDIV	Diversity RF Balun Center Tap. Connect bypass capacitors from this pin to ground.
9	RFDIV	Diversity Channel RF Input. This input is internally matched to 50Ω and is DC shorted to ground through a balun.
10, 16, 21, 30, 36	V _{CC}	Power-Supply Connections. Connect bypass capacitors as shown in the <i>Typical Application Circuit</i> .
13, 14	IFDIV+, IFDIV-	Differential IF Output for Diversity Mixer. Connect 560nH pullup inductors and 137Ω pullup resistors from each of these pins to V _{CC} for a 70MHz to 100MHz IF range.
19	LO1	Local Oscillator Input 1. This input is internally matched to 50Ω and is DC shorted to ground through a balun.
23	LOSEL	Local Oscillator Select. Set this pin to logic HIGH to select LO1; set to logic LOW to select LO2.
27	LO2	Local Oscillator Input 2. This input is internally matched to 50Ω and is DC shorted to ground through a balun.
32, 33	IFMAIN-, IFMAIN+	Differential IF Output for the Main Mixer. Connect 560nH pullup inductors and 137Ω pullup resistors from each of these pins to V _{CC} for a 70MHz to 100MHz IF range.

825MHz to 915MHz, Dual SiGe High-Linearity Active Mixer

Typical Application Circuit

MAX9981

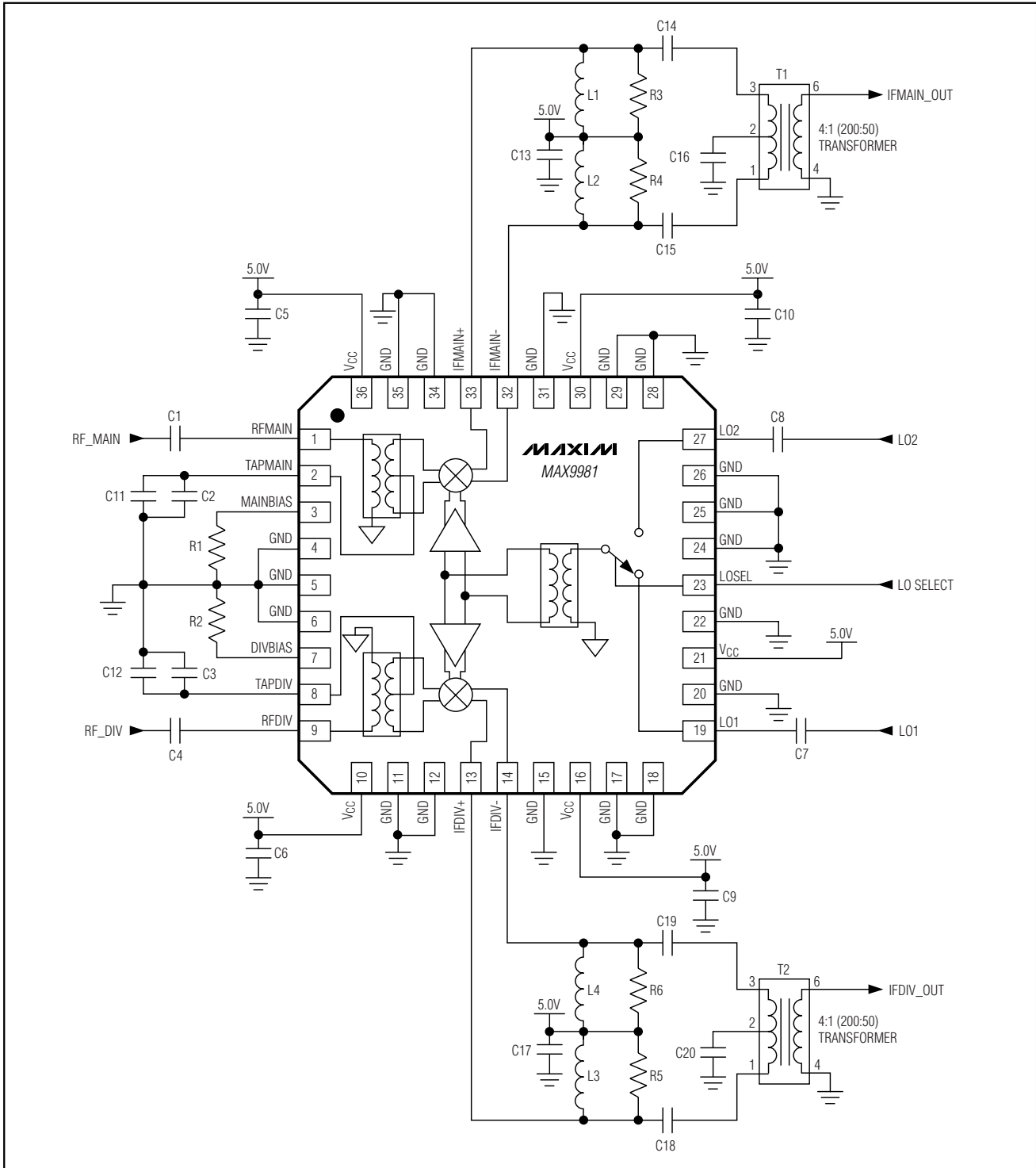

825MHz to 915MHz, Dual SiGe High-Linearity Active Mixer

Component List

COMPONENT	VALUE	SIZE	PART NUMBER
C1, C4	33pF	0603	Murata GRM1885C1H330J
C2, C3	3.9pF	0603	Murata GRM1885C1H3R9C
C5, C6, C9, C10	100pF	0603	Murata GRM1885C1H101J
C7, C8	15pF	0603	Murata GRM1885C1H150J
C11, C12	0.033 μ F	0603	Murata GRM188R71E333K
C13, C16, C17, C20	220pF	0603	Murata GRM1885C1H221J
C14, C15, C18, C19	330pF	0603	Murata GRM1885C1H331J
L1-L4	560nH	1008	CoilCraft 1008CS-561XJBB
R1, R2	267 Ω \pm 1%	0603	—
R3-R6	137 Ω \pm 1%	0603	—
T1, T2	4:1 (200:50)	—	Mini-Circuits TC4-1W-7A

Detailed Description

The MAX9981 downconverter mixers are designed for GSM and CDMA base-station receivers with an RF frequency between 825MHz and 915MHz. Each active mixer provides 2.1dB to 2.7dB of overall conversion gain to the receive signal, removing the need for an external IF amplifier. The mixers have excellent input IP3 measuring greater than +27dBm. The device also features integrated RF and LO baluns that allow the mixers to be driven with single-ended signals.

RF Inputs

The MAX9981 has two RF inputs (RFMAIN, RFDIV) that are internally matched to 50 Ω requiring no external matching components. A 33pF DC-blocking capacitor is required at the input since the input is internally DC shorted to ground through a balun. Return loss is better than 15dB over the entire frequency range of 825MHz to 915MHz.

LO Inputs

The mixers can be used for either high-side or low-side injection applications with an LO frequency range of 725MHz to 1085MHz. An internal LO switch allows for switching between two single-ended LO ports. This is useful for fast frequency changes/frequency hopping. LO switching time is less than 250ns. The switch is controlled by a digital input (LOSEL) that when high, selects LO1 and when low, selects LO2. The selected LO input mixes with both RFMAIN and RFDIV to produce the IF signals.

Internal LO buffers allow for a wide power range on the LO ports. The LO signal power can vary from -5dBm to +5dBm. LO1 and LO2 are internally matched to 50 Ω , so only a 15pF DC-blocking capacitor is required at each LO port.

IF Outputs

Each mixer has an IF frequency range of 70MHz to 170MHz. The differential IF output ports require external pullup inductors to V_{CC} to resonate out the differential on-chip capacitance of 1.8pF. See the *Typical Application Circuit* for recommended component values for an IF of 70MHz to 100MHz. The IF match can be optimized for higher IF frequencies by reducing the values of the pullup inductors L1, L2, L3, and L4. **Note:** Removing the ground plane from underneath these inductors reduces parasitic capacitive loading and improves VSWR.

Bias Circuitry

Connect bias resistors from MAINBIAS and DIVBIAS to ground to set the mixer bias current. A nominal resistor value of 267 Ω sets an input IP3 of +27dBm and supply current of 290mA. Bias currents are fine-tuned at the factory and should not be adjusted.

Applications Information

Layout Considerations

A properly designed PC board is an essential part of any RF/microwave circuit. Keep RF signal lines as short as possible to reduce losses, radiation, and inductance. For best performance, route the ground pin traces directly to the exposed paddle underneath the package. This paddle should be connected to the ground plane of the board by using multiple vias under the device to provide the best RF/thermal conduction path. Solder the exposed paddle, on the bottom of the device package, to a PC board exposed pad.

825MHz to 915MHz, Dual SiGe High-Linearity Active Mixer

Power Supply Bypassing

Proper voltage supply bypassing is essential for high-frequency circuit stability. Bypass each VCC pin, TAPMAIN, and TAPDIV with the capacitors shown in the typical application circuit. Place the TAPMAIN and TAPDIV bypass capacitors to ground within 100mils of the TAPMAIN and TAPDIV pins.

Chip Information

TRANSISTOR COUNT: 358

PROCESS: BiCMOS

MAX9981

825MHz to 915MHz, Dual SiGe High-Linearity Active Mixer

Package Information

(The package drawing(s) in this data sheet may not reflect the most current specifications. For the latest package outline information, go to www.maxim-ic.com/packages.)

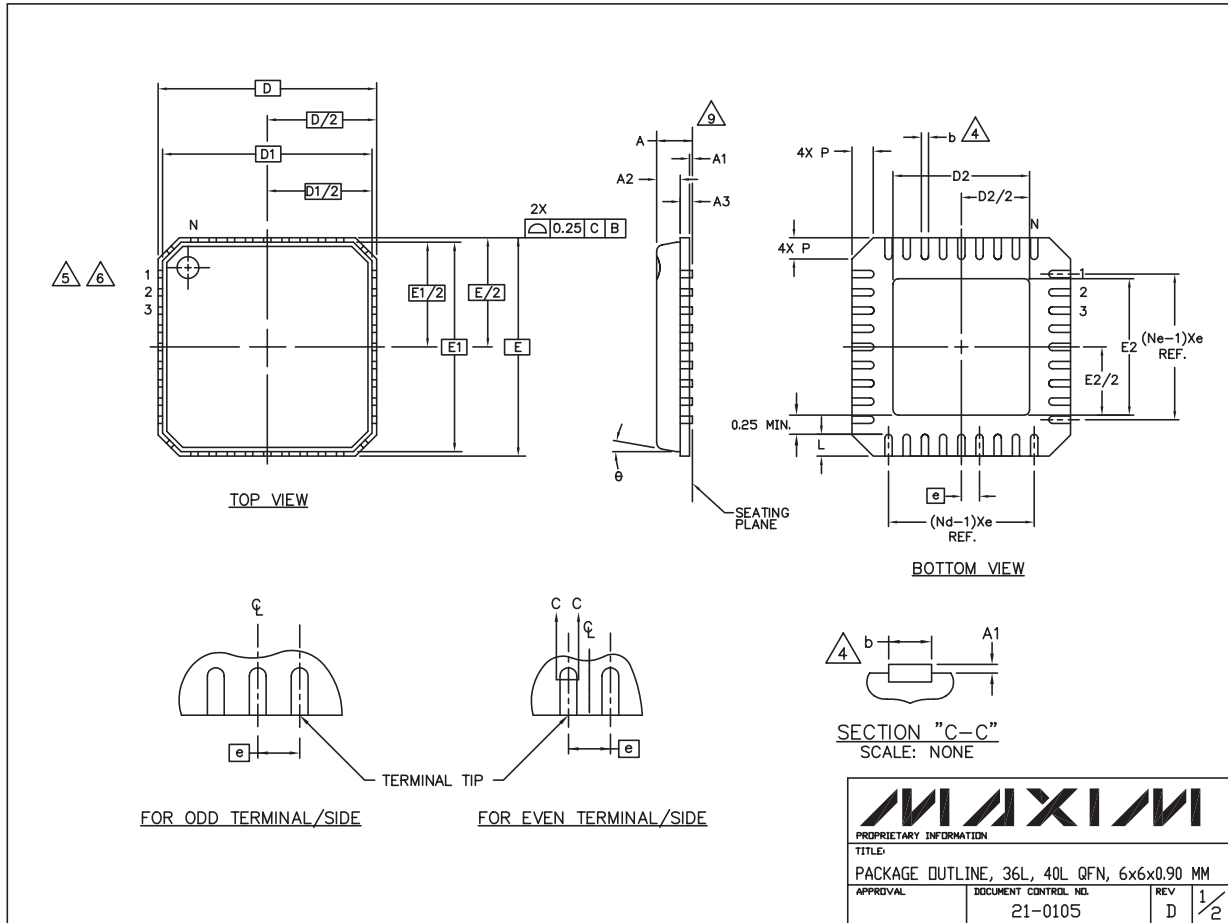

36L, 40L, QFN, EPS

MAXIM			
PROPRIETARY INFORMATION			
TITLE: PACKAGE OUTLINE, 36L, 40L, QFN, 6x6x0.90 MM			
APPROVAL	DOCUMENT CONTROL NO. 21-0105	REV D	1 2

825MHz to 915MHz, Dual SiGe High-Linearity Active Mixer

MAX9981

Package Information (continued)

(The package drawing(s) in this data sheet may not reflect the most current specifications. For the latest package outline information, go to www.maxim-ic.com/packages.)

NOTES:

1. DIE THICKNESS ALLOWABLE IS 0.305mm MAXIMUM (.012 INCHES MAXIMUM)
2. DIMENSIONING & TOLERANCES CONFORM TO ASME Y14.5M. – 1994.
3. N IS THE NUMBER OF TERMINALS.
Nd IS THE NUMBER OF TERMINALS IN X-DIRECTION &
Ne IS THE NUMBER OF TERMINALS IN Y-DIRECTION.
4. DIMENSION b APPLIES TO PLATED TERMINAL AND IS MEASURED BETWEEN 0.20 AND 0.25mm FROM TERMINAL TIP.
5. THE PIN #1 IDENTIFIER MUST BE EXISTED ON THE TOP SURFACE OF THE PACKAGE BY USING INDENTATION MARK OR INK/LASER MARKED.
6. EXACT SHAPE AND SIZE OF THIS FEATURE IS OPTIONAL.
7. ALL DIMENSIONS ARE IN MILLIMETERS.
8. PACKAGE WARPAGE MAX 0.05mm.
9. APPLIED FOR EXPOSED PAD AND TERMINALS.
EXCLUDE EMBEDDING PART OF EXPOSED PAD FROM MEASURING.
10. MEETS JEDEC MO220.
11. THIS PACKAGE OUTLINE APPLIES TO ANVIL SINGULATION (STEPPED SIDES) AND TO SAW SINGULATION (STRAIGHT SIDES) QFN STYLES.

SYMBOL	COMMON DIMENSIONS			NOTE
	MIN.	NOM.	MAX.	
A	0.80	0.90	1.00	
A1	0.00	0.01	0.05	
A2	0.00	0.65	0.80	
A3	0.20 REF.			
D	6.00 BSC			
D1	5.75 BSC			
E	6.00 BSC			
E1	5.75 BSC			
θ	0°		12°	
P	0		0.60	
D2	1.75		4.25	
E2	1.75		4.25	

SYMBOL	PITCH VARIATION C						
	MIN.	NOM.	MAX.	NOTE	MIN.	NOM.	MAX.
ⓐ	0.50 BSC				0.50 BSC		
N	36			3	40		
Nd	9			3	10		
Ne	9			3	10		
L	0.50	0.60	0.75		0.30	0.40	0.50
b	0.18	0.23	0.30	4	0.18	0.23	0.30

		
<small>PROPRIETARY INFORMATION</small>		
<small>TITLE</small>		
PACKAGE OUTLINE, 36L, 40L QFN, 6x6x0.90 MM		
<small>APPROVAL</small>	<small>DOCUMENT CONTROL NO.</small>	<small>REV</small>
	21-0105	D 2/2

Maxim cannot assume responsibility for use of any circuitry other than circuitry entirely embodied in a Maxim product. No circuit patent licenses are implied. Maxim reserves the right to change the circuitry and specifications without notice at any time.

Maxim Integrated Products, 120 San Gabriel Drive, Sunnyvale, CA 94086 408-737-7600 _____ 15

Компания «Океан Электроники» предлагает заключение долгосрочных отношений при поставках импортных электронных компонентов на взаимовыгодных условиях!

Наши преимущества:

- Поставка оригинальных импортных электронных компонентов напрямую с производств Америки, Европы и Азии, а так же с крупнейших складов мира;
- Широкая линейка поставок активных и пассивных импортных электронных компонентов (более 30 млн. наименований);
- Поставка сложных, дефицитных, либо снятых с производства позиций;
- Оперативные сроки поставки под заказ (от 5 рабочих дней);
- Экспресс доставка в любую точку России;
- Помощь Конструкторского Отдела и консультации квалифицированных инженеров;
- Техническая поддержка проекта, помощь в подборе аналогов, поставка прототипов;
- Поставка электронных компонентов под контролем ВП;
- Система менеджмента качества сертифицирована по Международному стандарту ISO 9001;
- При необходимости вся продукция военного и аэрокосмического назначения проходит испытания и сертификацию в лаборатории (по согласованию с заказчиком);
- Поставка специализированных компонентов военного и аэрокосмического уровня качества (Xilinx, Altera, Analog Devices, Intersil, Interpoint, Microsemi, Actel, Aeroflex, Peregrine, VPT, Syfer, Eurofarad, Texas Instruments, MS Kennedy, Miteq, Cobham, E2V, MA-COM, Hittite, Mini-Circuits, General Dynamics и др.);

Компания «Океан Электроники» является официальным дистрибьютором и эксклюзивным представителем в России одного из крупнейших производителей разъемов военного и аэрокосмического назначения «JONHON», а так же официальным дистрибьютором и эксклюзивным представителем в России производителя высокотехнологичных и надежных решений для передачи СВЧ сигналов «FORSTAR».



JONHON

«JONHON» (основан в 1970 г.)

Разъемы специального, военного и аэрокосмического назначения:

(Применяются в военной, авиационной, аэрокосмической, морской, железнодорожной, горно- и нефтедобывающей отраслях промышленности)

«FORSTAR» (основан в 1998 г.)

ВЧ соединители, коаксиальные кабели, кабельные сборки и микроволновые компоненты:

(Применяются в телекоммуникациях гражданского и специального назначения, в средствах связи, РЛС, а так же военной, авиационной и аэрокосмической отраслях промышленности).



Телефон: 8 (812) 309-75-97 (многоканальный)

Факс: 8 (812) 320-03-32

Электронная почта: ocean@oceanchips.ru

Web: <http://oceanchips.ru/>

Адрес: 198099, г. Санкт-Петербург, ул. Калинина, д. 2, корп. 4, лит. А