

FEATURES

High dynamic range, dual digital-to-analog converters (DACs)
Low noise and intermodulation distortion
Single carrier W-CDMA ACLR = 80 dBc at 61.44 MHz intermediate frequency (IF)
Innovative switching output stage permits useable outputs beyond Nyquist frequency
LVC MOS inputs with dual-port or optional interleaved single-port operation
Differential analog current outputs are programmable from 8.6 mA to 31.7 mA full-scale
Auxiliary 10-bit current DACs with source/sink capability for external offset nulling
Internal 1.2 V precision reference voltage source
Operates from 1.8 V and 3.3 V supplies
315 mW power dissipation
Small footprint, RoHS-compliant, 72-lead LFCSP

APPLICATIONS

Wireless infrastructure

W-CDMA, CDMA2000, TD-SCDMA, WiMAX

Wideband communications: LMDS/MMDS, point-to-point

Instrumentation

Radio frequency (RF) signal generators, arbitrary waveform generators

GENERAL DESCRIPTION

The AD9743/AD9745/AD9746/AD9747 are pin-compatible, high dynamic range, dual DACs with 10-/12-/14-/16-bit resolutions and sample rates of up to 250 MSPS. The devices include specific features for direct conversion transmit applications, including gain and offset compensation, and they interface seamlessly with analog quadrature modulators, such as the ADL5370.

A proprietary, dynamic output architecture permits synthesis of analog outputs even above Nyquist by shifting energy away from the fundamental and into the image frequency.

A serial peripheral interface (SPI) port provides full programmability. In addition, some pin-programmable features are offered for those applications without a controller.

PRODUCT HIGHLIGHTS

1. Low noise and intermodulation distortion (IMD) enables high quality synthesis of wideband signals.
2. Proprietary switching output for enhanced dynamic performance.
3. Programmable current outputs and dual auxiliary DACs provide flexibility and system enhancements.

FUNCTIONAL BLOCK DIAGRAM

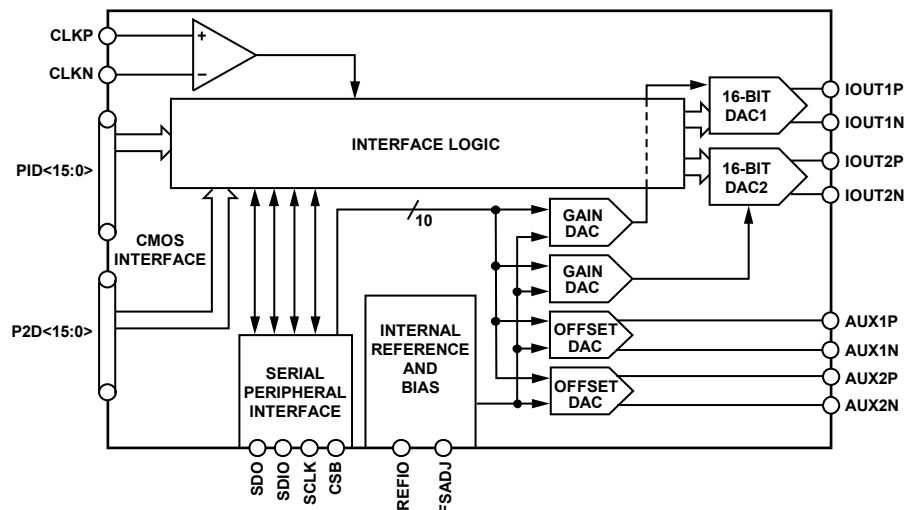

Figure 1.

Rev. B

[Document Feedback](#)

Information furnished by Analog Devices is believed to be accurate and reliable. However, no responsibility is assumed by Analog Devices for its use, nor for any infringements of patents or other rights of third parties that may result from its use. Specifications subject to change without notice. No license is granted by implication or otherwise under any patent or patent rights of Analog Devices. Trademarks and registered trademarks are the property of their respective owners.

One Technology Way, P.O. Box 9106, Norwood, MA 02062-9106, U.S.A.
 Tel: 781.329.4700 ©2007–2015 Analog Devices, Inc. All rights reserved.
[Technical Support](#) www.analog.com

TABLE OF CONTENTS

Features	1	Instruction Byte	21
Applications	1	MSB/LSB Transfers	22
General Description	1	Serial Interface Port Pin Descriptions	22
Product Highlights	1	SPI Register Map	23
Functional Block Diagram	1	SPI Register Descriptions	24
Revision History	2	Digital Inputs and Outputs	25
Specifications	3	Input Data Timing	25
DC Specifications	3	Dual-Port Mode Timing	25
AC Specifications	5	Single-Port Mode Timing	25
Digital and Timing Specifications	7	SPI Port, Reset, and Pin Mode	25
Absolute Maximum Ratings	8	Driving the DAC Clock Input	26
Thermal Resistance	8	Full-Scale Current Generation	26
ESD Caution	8	DAC Transfer Function	27
Pin Configurations and Function Descriptions	9	Analog Modes of Operation	27
Typical Performance Characteristics	17	Auxiliary DACS	28
Terminology	20	Power Dissipation	28
Theory of Operation	21	Outline Dimensions	30
SPI PORT	21	Ordering Guide	30
General Operation of the Serial Interface	21		

REVISION HISTORY

9/15—Rev. A to Rev. B

Deleted AD9741	Universal
Changed NC to DNC	Throughout
Deleted Figure 2; Renumbered Sequentially and Table 8; Renumbered Sequentially	9
Changes to Figure 2	9
Changes to Figure 3	11
Changes to Figure 4	13
Changes to Figure 5	15
Changes to Figure 12 Caption, Figure 13 Caption, Figure 15 Caption, and Figure 16 Caption	18

Changes to Figure 19 and Figure 20	19
Changes to Figure 39 and Figure 40	28
Changes to Ordering Guide	31

1/14—Rev. 0 to Rev. A

Changes to Table 15	21
Updated Outline Dimensions	27
Changes to Ordering Guide	27

5/07—Revision 0: Initial Version

SPECIFICATIONS

DC SPECIFICATIONS

T_{MIN} to T_{MAX} , AVDD33 = 3.3 V, DVDD33 = 3.3 V, DVDD18 = 1.8 V, CVDD18 = 1.8 V, I_{FS} = 20 mA, full-scale digital input, maximum sample rate, unless otherwise noted.

Table 1. AD9743 and AD9745

Parameter	AD9743			AD9745			Unit
	Min	Typ	Max	Min	Typ	Max	
RESOLUTION	10			12			Bits
ACCURACY							
Differential Nonlinearity (DNL)	±0.05			±0.13			LSB
Integral Nonlinearity (INL)	±0.10			±0.25			LSB
MAIN DAC OUTPUTS							
Offset Error	±0.001			±0.001			%FSR
Offset Error Temperature Coefficient	1.0			1.0			ppm/°C
Gain Error	±2.0			±2.0			%FSR
Gain Error Temperature Coefficient	100			100			ppm/°C
Gain Matching (DAC1 to DAC2)	±1.0			±1.0			%FSR
Full-Scale Output Current	8.6		31.7	8.6		31.7	mA
Output Compliance Voltage	-1.0		+1.0	-1.0		+1.0	V
Output Resistance	10			10			MΩ
AUXILIARY DAC OUTPUTS							
Resolution	10			10			Bits
Full-Scale Output Current	-2.0		+2.0	-2.0		+2.0	mA
Output Compliance Voltage Range—Sink Current	0.8		1.6	0.8		1.6	V
Output Compliance Voltage Range—Source Current	0		1.6	0		1.6	V
Output Resistance	1			1			MΩ
Monotonicity	10			10			Bits
REFERENCE INPUT/OUTPUT							
Output Voltage	1.2			1.2			V
Output Voltage Temperature Coefficient	10			10			ppm/°C
External Input Voltage Range	1.15		1.3	1.15		1.3	V
Input or Output Resistance	5			5			kΩ
POWER SUPPLY VOLTAGES							
AVDD33, DVDD33	3.13		3.47	3.13		3.47	V
CVDD18, DVDD18	1.70		1.90	1.70		1.90	V
POWER SUPPLY CURRENTS							
I_{AVDD33}	56		60	56		60	mA
I_{DVDD33}	10		14	11		15	mA
I_{CVDD18}	18		22	18		22	mA
I_{DVDD18}	29		33	30		34	mA
POWER DISSIPATION							
f_{DAC} = 250 MSPS, f_{OUT} = 20 MHz	300		345	305		350	mW
DAC Outputs Disabled	115			120			mW
Full Device Power-Down	3			3			mW
OPERATING TEMPERATURE	-40		+85	-40		+85	°C

T_{MIN} to T_{MAX} , AVDD33 = 3.3 V, DVDD33 = 3.3 V, DVDD18 = 1.8 V, CVDD18 = 1.8 V, I_{FS} = 20 mA, full-scale digital input, maximum sample rate, unless otherwise noted. The AD9745 is repeated in Table 2 so the user can compare it with all other parts.

Table 2. AD9745, AD9746, and AD9747

Parameter	AD9745			AD9746			AD9747			Unit
	Min	Typ	Max	Min	Typ	Max	Min	Typ	Max	
RESOLUTION		12			14			16		Bits
ACCURACY										
Differential Nonlinearity (DNL)		±0.13			±0.5			±2.0		LSB
Integral Nonlinearity (INL)		±0.25			±1.0			±4.0		LSB
MAIN DAC OUTPUTS										
Offset Error		±0.001			±0.001			±0.001		%FSR
Offset Error Temperature Coefficient		0.1			0.1			0.1		ppm/°C
Gain Error		±2.0			±2.0			±2.0		%FSR
Gain Error Temperature Coefficient		100			100			100		ppm/°C
Gain Matching (DAC1 to DAC2)		±1.0			±1.0			±1.0		%FSR
Full-Scale Output Current	8.6		31.7	8.6		31.7	8.6		31.7	mA
Output Compliance Voltage	-1.0		+1.0	-1.0		+1.0	-1.0		+1.0	V
Output Resistance		10			10			10		MΩ
AUXILIARY DAC OUTPUTS										
Resolution		10			10			10		Bits
Full-Scale Output Current	-2.0		+2.0	-2.0		+2.0	-2.0		+2.0	mA
Output Compliance Voltage Range—Sink Current	0.8		1.6	0.8		1.6	0.8		1.6	V
Output Compliance Voltage Range—Source Current	0		1.6	0		1.6	0		1.6	V
Output Resistance		1			1			1		MΩ
Monotonicity		10			10			10		Bits
REFERENCE INPUT/OUTPUT										
Output Voltage		1.2			1.2			1.2		V
Output Voltage Temperature Coefficient		10			10			10		ppm/°C
External Input Voltage Range	1.15		1.3	1.15		1.3	1.15		1.3	V
Input or Output Resistance		5			5			5		kΩ
POWER SUPPLY VOLTAGES										
AVDD33, DVDD33	3.13		3.47	3.13		3.47	3.13		3.47	V
CVDD18, DVDD18	1.70		1.90	1.70		1.90	1.70		1.90	V
POWER SUPPLY CURRENTS										
I_{AVDD33}		56	60		56	60		56	60	mA
I_{DVDD33}		11	15		12	16		12	16	mA
I_{CVDD18}		18	22		18	22		18	22	mA
I_{DVDD18}		30	34		31	35		32	36	mA
POWER DISSIPATION										
f_{DAC} = 250 MSPS, f_{OUT} = 20 MHz		305	350		310	355		310	355	mW
DAC Outputs Disabled		120			125			125		mW
Full Device Power-Down		3			3			3		mW
OPERATING TEMPERATURE	-40		+85	-40		+85	-40		+85	°C

AC SPECIFICATIONS

T_{MIN} to T_{MAX} , $AVDD33 = 3.3$ V, $DVDD33 = 3.3$ V, $DVDD18 = 1.8$ V, $CVDD18 = 1.8$ V, $I_{FS} = 20$ mA, full-scale digital input, maximum sample rate, unless otherwise noted.

Table 3. AD9743 and AD9745

Parameter	AD9743			AD9745			Unit
	Min	Typ	Max	Min	Typ	Max	
SPURIOUS FREE DYNAMIC RANGE (SFDR)							
$f_{DAC} = 250$ MSPS, $f_{OUT} = 20$ MHz		80			82		dBc
$f_{DAC} = 250$ MSPS, $f_{OUT} = 70$ MHz		70			70		dBc
$f_{DAC} = 250$ MSPS, $f_{OUT} = 180$ MHz ¹		64			66		dBc
INTERMODULATION DISTORTION (IMD)							
$f_{DAC} = 250$ MSPS, $f_{OUT} = 20$ MHz		80			86		dBc
$f_{DAC} = 250$ MSPS, $f_{OUT} = 70$ MHz		80			80		dBc
$f_{DAC} = 250$ MSPS, $f_{OUT} = 180$ MHz ¹		72			74		dBc
CROSSTALK							
$f_{DAC} = 250$ MSPS, $f_{OUT} = 20$ MHz		80			80		dBc
$f_{DAC} = 250$ MSPS, $f_{OUT} = 70$ MHz		80			80		dBc
$f_{DAC} = 250$ MSPS, $f_{OUT} = 180$ MHz ¹		80			80		dBc
ADJACENT CHANNEL LEAKAGE RATIO (ACLR) SINGLE CARRIER W-CDMA							
$f_{DAC} = 245.76$ MSPS, $f_{OUT} = 15.36$ MHz		66			76		dBc
$f_{DAC} = 245.76$ MSPS, $f_{OUT} = 61.44$ MHz		66			76		dBc
$f_{DAC} = 245.76$ MSPS, $f_{OUT} = 184.32$ MHz ¹		64			72		dBc
NOISE SPECTRAL DENSITY (NSD)							
$f_{DAC} = 245.76$ MSPS, $f_{OUT} = 15.36$ MHz		-144			-155		dBm/Hz
$f_{DAC} = 245.76$ MSPS, $f_{OUT} = 61.44$ MHz		-144			-155		dBm/Hz
$f_{DAC} = 245.76$ MSPS, $f_{OUT} = 184.32$ MHz ¹		-147			-155		dBm/Hz

¹ Mix mode.

T_{MIN} to T_{MAX} , $AVDD33 = 3.3$ V, $DVDD33 = 3.3$ V, $DVDD18 = 1.8$ V, $CVDD18 = 1.8$ V, $I_{FS} = 20$ mA, full-scale digital input, maximum sample rate, unless otherwise noted. The AD9745 is repeated in Table 4 so the user can compare it with all other parts.

Table 4. AD9745, AD9746, and AD9747

Parameter	AD9745			AD9746			AD9747			Unit
	Min	Typ	Max	Min	Typ	Max	Min	Typ	Max	
SPURIOUS FREE DYNAMIC RANGE (SFDR)										
$f_{DAC} = 250$ MSPS, $f_{OUT} = 20$ MHz		82			82			82		dBc
$f_{DAC} = 250$ MSPS, $f_{OUT} = 70$ MHz		70			70			70		dBc
$f_{DAC} = 250$ MSPS, $f_{OUT} = 180$ MHz ¹		66			66			66		dBc
INTERMODULATION DISTORTION (IMD)										
$f_{DAC} = 250$ MSPS, $f_{OUT} = 20$ MHz		86			86			86		dBc
$f_{DAC} = 250$ MSPS, $f_{OUT} = 70$ MHz		80			80			80		dBc
$f_{DAC} = 250$ MSPS, $f_{OUT} = 180$ MHz ¹		74			74			74		dBc
CROSSTALK										
$f_{DAC} = 250$ MSPS, $f_{OUT} = 20$ MHz		80			80			80		dBc
$f_{DAC} = 250$ MSPS, $f_{OUT} = 70$ MHz		80			80			80		dBc
$f_{DAC} = 250$ MSPS, $f_{OUT} = 180$ MHz ¹		80			80			80		dBc
ADJACENT CHANNEL LEAKAGE RATIO (ACLR) SINGLE CARRIER W-CDMA										
$f_{DAC} = 245.76$ MSPS, $f_{OUT} = 15.36$ MHz		76			78			82		dBc
$f_{DAC} = 245.76$ MSPS, $f_{OUT} = 61.44$ MHz		76			78			80		dBc
$f_{DAC} = 245.76$ MSPS, $f_{OUT} = 184.32$ MHz ¹		72			74			74		dBc
NOISE SPECTRAL DENSITY (NSD)										
$f_{DAC} = 245.76$ MSPS, $f_{OUT} = 15.36$ MHz		-155			-163			-165		dBm/Hz
$f_{DAC} = 245.76$ MSPS, $f_{OUT} = 61.44$ MHz		-155			-160			-162		dBm/Hz
$f_{DAC} = 245.76$ MSPS, $f_{OUT} = 184.32$ MHz ¹		-155			-158			-160		dBm/Hz

¹ Mix mode.

DIGITAL AND TIMING SPECIFICATIONS

T_{MIN} to T_{MAX} , AVDD33 = 3.3 V, DVDD33 = 3.3 V, DVDD18 = 1.8 V, CVDD18 = 1.8 V, I_{FS} = 20 mA, full-scale digital input, maximum sample rate, unless otherwise noted.

Table 5. AD9743/AD9745/AD9746/AD9747

Parameter	Min	Typ	Max	Unit
DAC CLOCK INPUTS (CLKP, CLKN)				
Differential Peak-to-Peak Voltage	400	800	1600	mV
Single-Ended Peak-to-Peak Voltage			800	mV
Common-Mode Voltage	300	400	500	mV
Input Current			1	μ A
Input Frequency			250	MHz
DATA CLOCK OUTPUT (DCO)				
Output Voltage High	2.4			V
Output Voltage Low			0.4	V
Output Current			10	mA
DAC Clock to Data Clock Output Delay (t_{DCO})	2.0	2.2	2.8	ns
DATA PORT INPUTS				
Input Voltage High	2.0			V
Input Voltage Low			0.8	V
Input Current			1	μ A
Data to DAC Clock Setup Time (t_{DBS} Dual-Port Mode)	400			ps
Data to DAC Clock Hold Time (t_{DBH} Dual-Port Mode)	1200			ps
DAC Clock to Analog Output Data Latency (Dual-Port Mode)			7	Cycles
Data or IQSEL Input to DAC Clock Setup Time (t_{DBS} Single-Port Mode)	400			ps
Data or IQSEL Input to DAC Clock Hold Time (t_{DBH} Single-Port Mode)	1200			ps
DAC Clock to Analog Output Data Latency (Single-Port Mode)			8	Cycles
SERIAL PERIPHERAL INTERFACE				
SCLK Frequency (f_{SCLK})			40	MHz
SCLK Pulse Width High (t_{PWH})	10			ns
SCLK Pulse Width Low (t_{PWL})	10			ns
CSB to SCLK Setup Time (t_s)	1			ns
CSB to SCLK Hold Time (t_H)	0			ns
SDIO to SCLK Setup Time (t_{DS})	1			ns
SDIO to SCLK Hold Time (t_{DH})	0			ns
SCLK to SDIO/SDO Data Valid Time (t_{DV})			1	ns
RESET Pulse Width High	10			ns
WAKE-UP TIME AND OUTPUT LATENCY				
From DAC Outputs Disabled		200		μ s
From Full Device Power-Down		1200		μ s
DAC Clock to Analog Output Latency (Dual-Port Mode)		7		Cycles
DAC Clock to Analog Output Latency (Single-Port Mode)		8		Cycles

ABSOLUTE MAXIMUM RATINGS

Table 6.

Parameter	With Respect to	Rating
AVDD33, DVDD33	AVSS DVSS CVSS	-0.3 V to +3.6 V
DVDD18, CVDD18	AVSS DVSS CVSS	-0.3 V to +1.98 V
AVSS	DVSS CVSS	-0.3 V to +0.3 V
DVSS	AVSS CVSS	-0.3 V to +0.3 V
CVSS	AVSS DVSS	-0.3 V to +0.3 V
REFIO	AVSS	-0.3 V to AVDD33 + 0.3 V
IOUT1P, IOUT1N, IOUT2P, IOUT2P, AUX1P, AUX1N, AUX2P, AUX2N	AVSS	-1.0 V to AVDD33 + 0.3 V
P1D15 to P1D0, P2D15 to P2D0	DVSS	-0.3 V to DVDD33 + 0.3 V
CLKP, CLKN	CVSS	-0.3 V to CVDD18 + 0.3 V
RESET, CSB, SCLK, SDIO, SDO	DVSS	-0.3 V to DVDD33 + 0.3 V
Junction Temperature		125°C
Storage Temperature Range		-65°C to +150°C

Stresses at or above those listed under Absolute Maximum Ratings may cause permanent damage to the product. This is a stress rating only; functional operation of the product at these or any other conditions above those indicated in the operational section of this specification is not implied. Operation beyond the maximum operating conditions for extended periods may affect product reliability.

THERMAL RESISTANCE

Thermal resistance tested using JEDEC standard 4-layer thermal test board with no airflow.

Table 7.

Package Type	θ_{JA}	Unit
CP-72-1 (Exposed Pad Soldered to PCB)	25	°C/W

ESD CAUTION



ESD (electrostatic discharge) sensitive device. Charged devices and circuit boards can discharge without detection. Although this product features patented or proprietary protection circuitry, damage may occur on devices subjected to high energy ESD. Therefore, proper ESD precautions should be taken to avoid performance degradation or loss of functionality.

PIN CONFIGURATIONS AND FUNCTION DESCRIPTIONS



1. DNC = DO NOT CONNECT. DO NOT CONNECT TO THESE PINS.
2. THE EXPOSED THERMAL PAD MUST BE SOLDERED TO COPPER POUR ON TOP SURFACE OF PCB FOR MECHANICAL STABILITY AND MUST BE ELECTRICALLY TIED TO LOW IMPEDANCE GND PLANE FOR LOW NOISE PERFORMANCE.

06569-005

Figure 2. AD9743 Pin Configuration

Table 8. AD9743 Pin Function Descriptions

Pin No.	Mnemonic	Description
1, 6	CVDD18	Clock Supply Voltage (1.8 V).
2, 5	CVSS	Clock Supply Common (0 V).
3	CLKP	Differential DAC Clock Input.
4	CLKN	Complementary Differential DAC Clock Input.
7, 28, 48	DVSS	Digital Supply Common (0 V).
8, 47	DVDD18	Digital Core Supply Voltage (1.8 V).
9 to 18	P1D9, P1D8, P1D7, P1D6, P1D5, P1D4, P1D3, P1D2, P1D1, P1D0	Port 1 Data Bit Inputs.
19 to 24, 26, 30, 41 to 46	DNC	Do Not Connect. Do not connect to these pins.
25	DCO	Data Clock Output. Use to clock data source.
27	DVDD33	Digital Input/Output Supply Voltage (3.3 V).
29	IQSEL	I/Q Framing Signal for Single-Port Mode Operation.
31 to 40	P2D9, P2D8, P2D7, P2D6, P2D5, P2D4, P2D3, P2D2, P2D1, P2D0	Port 2 Data Bit Inputs.
49	SDO	Serial Peripheral Interface Data Output.
50	SDIO	Serial Peripheral Interface Data Input and Optional Data Output.
51	SCLK	Serial Peripheral Interface Clock Input.
52	CSB	Serial Peripheral Interface Chip Select Input. Active low.
53	RESET	Hardware Reset. Active high.
54	FSADJ	Full-Scale Current Output Adjust. Connect a 10 kΩ resistor to AVSS.
55	REFIO	Reference Input/Output. Connect a 0.1 μF capacitor to AVSS.
56, 57, 71, 72	AVDD33	Analog Supply Voltage (3.3 V).
58, 61, 64, 67, 70	AVSS	Analog Supply Common (0 V).

Pin No.	Mnemonic	Description
59	IOUT2P	DAC2 Current Output True. Sources full-scale current when input data bits are all 1.
60	IOUT2N	DAC2 Current Output Complement. Sources full-scale current when data bits are all 0.
62	AUX2P	Auxiliary DAC2 Default Current Output Pin.
63	AUX2N	Auxiliary DAC2 Optional Output Pin. Enable through SPI.
65	AUX1N	Auxiliary DAC1 Optional Output Pin. Enable through SPI.
66	AUX1P	Auxiliary DAC1 Default Current Output Pin.
68	IOUT1N	Complementary DAC1 Current Output. Sources full-scale current when data bits are all 0.
69	IOUT1P	DAC1 Current Output. Sources full-scale current when data bits are all 1.
	EPAD	Exposed Thermal Pad. The exposed thermal pad must be soldered to copper pour on top surface of PCB for mechanical stability and must be electrically tied to low impedance GND plane for low noise performance.

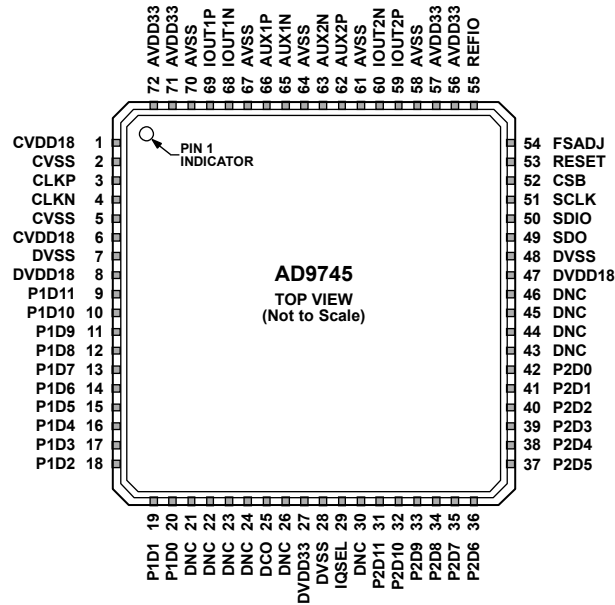

1. DNC = DO NOT CONNECT. DO NOT CONNECT TO THESE PINS.
2. THE EXPOSED THERMAL PAD MUST BE SOLDERED TO COPPER POUR ON TOP SURFACE OF PCB FOR MECHANICAL STABILITY AND MUST BE ELECTRICALLY TIED TO LOW IMPEDANCE GND PLANE FOR LOW NOISE PERFORMANCE.

06569-004

Figure 3. AD9745 Pin Configuration

Table 9. AD9745 Pin Function Descriptions

Pin No.	Mnemonic	Description
1, 6	CVDD18	Clock Supply Voltage (1.8 V).
2, 5	CVSS	Clock Supply Common (0 V).
3	CLKP	Differential DAC Clock Input.
4	CLKN	Complementary Differential DAC Clock Input.
7, 28, 48	DVSS	Digital Supply Common (0 V).
8, 47	DVDD18	Digital Core Supply Voltage (1.8 V).
9 to 20	P1D11, P1D10, P1D9, P1D8, P1D7, P1D6, P1D5, P1D4, P1D3, P1D2, P1D1, P1D0	Port 1 Data Bit Inputs.
21 to 24, 26, 30, 43 to 46	DNC	Do Not Connect. Do not connect to these pins.
25	DCO	Data Clock Output. Use to clock data source.
27	DVDD33	Digital Input/Output Supply Voltage (3.3 V).
29	IQSEL	I/Q Framing Signal for Single-Port Mode Operation.
31 to 42	P2D11, P2D10, P2D9, P2D8, P2D7, P2D6, P2D5, P2D4, P2D3, P2D2, P2D1, P2D0	Port 2 Data Bit Inputs.
49	SDO	Serial Peripheral Interface Data Output.
50	SDIO	Serial Peripheral Interface Data Input and Optional Data Output.
51	SCLK	Serial Peripheral Interface Clock Input.
52	CSB	Serial Peripheral Interface Chip Select Input. Active low.
53	RESET	Hardware Reset. Active high.
54	FSADJ	Full-Scale Current Output Adjust. Connect 10 kΩ resistor to AVSS.
55	REFIO	Reference Input/Output. Connect a 0.1 μF capacitor to AVSS.
56, 57, 71, 72	AVDD33	Analog Supply Voltage (3.3 V).
58, 61, 64, 67, 70	AVSS	Analog Supply Common (0 V).

Pin No.	Mnemonic	Description
59	IOUT2P	DAC2 Current Output True. Sources full-scale current when input data bits are all 1.
60	IOUT2N	DAC2 Current Output Complement. Sources full-scale current when data bits are all 0.
62	AUX2P	Auxiliary DAC2 Default Current Output Pin.
63	AUX2N	Auxiliary DAC2 Optional Output Pin. Enable through SPI.
65	AUX1N	Auxiliary DAC1 Optional Output Pin. Enable through SPI.
66	AUX1P	Auxiliary DAC1 Default Current Output Pin.
68	IOUT1N	Complementary DAC1 Current Output. Sources full-scale current when data bits are all 0.
69	IOUT1P	DAC1 Current Output. Sources full-scale current when data bits are all 1.
	EPAD	Exposed Thermal Pad. The exposed thermal pad must be soldered to copper pour on top surface of PCB for mechanical stability and must be electrically tied to low impedance GND plane for low noise performance.

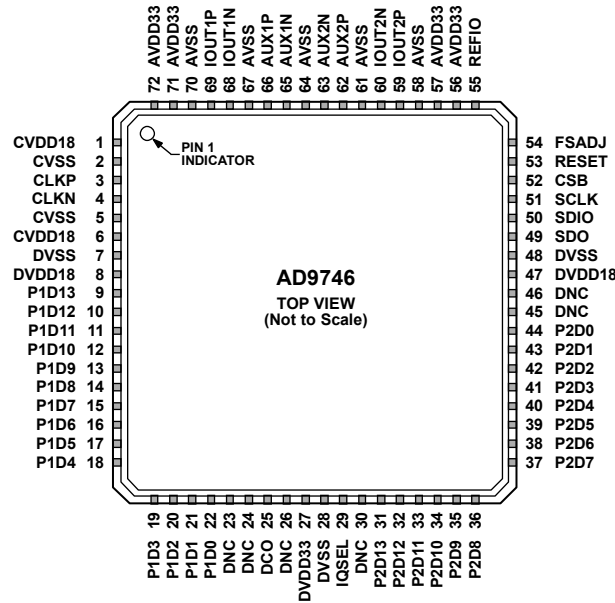

1. DNC = DO NOT CONNECT. DO NOT CONNECT TO THESE PINS.
2. THE EXPOSED THERMAL PAD MUST BE SOLDERED TO COPPER POUR ON TOP SURFACE OF PCB FOR MECHANICAL STABILITY AND MUST BE ELECTRICALLY TIED TO LOW IMPEDANCE GND PLANE FOR LOW NOISE PERFORMANCE.

08569-003

Figure 4. AD9746 Pin Configuration

Table 10. AD9746 Pin Function Descriptions

Pin No.	Mnemonic	Description
1, 6	CVDD18	Clock Supply Voltage (1.8 V).
2, 5	CVSS	Clock Supply Common (0 V).
3	CLKP	Differential DAC Clock Input.
4	CLKN	Complementary Differential DAC Clock Input.
7, 28, 48	DVSS	Digital Supply Common (0 V).
8, 47	DVDD18	Digital Core Supply Voltage (1.8 V).
9 to 22	P1D13, P1D12, P1D11, P1D10, P1D9, P1D8, P1D7, P1D6, P1D5, P1D4, P1D3, P1D2, P1D1, P1D0	Port 1 Data Bit Inputs.
23, 24, 26, 30, 45, 46	DNC	Do Not Connect. Do not connect to these pins.
25	DCO	Data Clock Output. Use to clock data source.
27	DVDD33	Digital Input/Output Supply Voltage (3.3 V).
29	IQSEL	I/Q Framing Signal for Single-Port Mode Operation.
31 to 44	P2D13, P2D12, P2D11, P2D10, P2D9, P2D8, P2D7, P2D6, P2D5, P2D4, P2D3, P2D2, P2D1, P2D0	Port 2 Data Bit Inputs.
49	SDO	Serial Peripheral Interface Data Output.
50	SDIO	Serial Peripheral Interface Data Input and Optional Data Output.
51	SCLK	Serial Peripheral Interface Clock Input.
52	CSB	Serial Peripheral Interface Chip Select Input. Active low.
53	RESET	Hardware Reset. Active high.
54	FSADJ	Full-Scale Current Output Adjust. Connect a 10 kΩ resistor to AVSS.
55	REFIO	Reference Input/Output. Connect a 0.1 μF capacitor to AVSS.
56, 57, 71, 72	AVDD33	Analog Supply Voltage (3.3 V).
58, 61, 64, 67, 70	AVSS	Analog Supply Common (0 V).

Pin No.	Mnemonic	Description
59	IOUT2P	DAC2 Current Output True. Sources full-scale current when input data bits are all 1.
60	IOUT2N	DAC2 Current Output Complement. Sources full-scale current when data bits are all 0.
62	AUX2P	Auxiliary DAC2 Default Current Output Pin.
63	AUX2N	Auxiliary DAC2 Optional Output Pin. Enable through SPI.
65	AUX1N	Auxiliary DAC1 Optional Output Pin. Enable through SPI.
66	AUX1P	Auxiliary DAC1 Default Current Output Pin.
68	IOUT1N	Complementary DAC1 Current Output. Sources full-scale current when data bits are all 0.
69	IOUT1P	DAC1 Current Output. Sources full-scale current when data bits are all 1.
	EPAD	Exposed Thermal Pad. The exposed thermal pad must be soldered to copper pour on top surface of PCB for mechanical stability and must be electrically tied to low impedance GND plane for low noise performance.

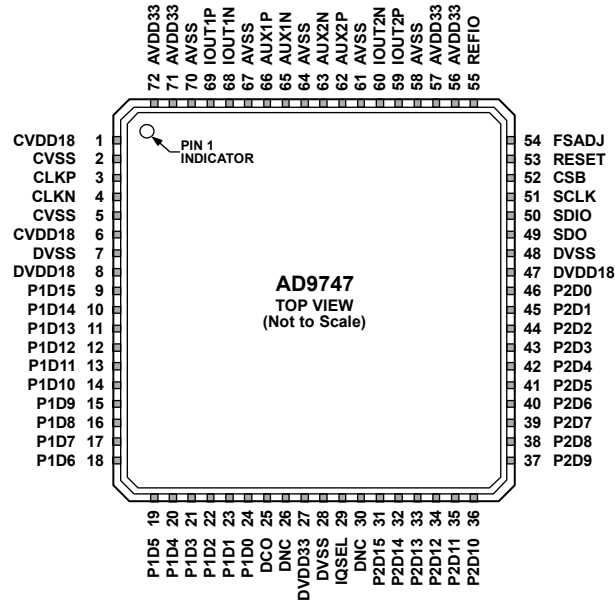

1. DNC = DO NOT CONNECT. DO NOT CONNECT TO THESE PINS.
2. THE EXPOSED THERMAL PAD MUST BE SOLDERED TO COPPER POUR ON TOP SURFACE OF PCB FOR MECHANICAL STABILITY AND MUST BE ELECTRICALLY TIED TO LOW IMPEDANCE GND PLANE FOR LOW NOISE PERFORMANCE.

06568-002

Figure 5. AD9747 Pin Configuration

Table 11. AD9747 Pin Function Descriptions

Pin No.	Mnemonic	Description
1, 6	CVDD18	Clock Supply Voltage (1.8 V).
2, 5	CVSS	Clock Supply Common (0 V).
3	CLKP	Differential DAC Clock Input.
4	CLKN	Complementary Differential DAC Clock Input.
7, 28, 48	DVSS	Digital Supply Common (0 V).
8, 47	DVDD18	Digital Core Supply Voltage (1.8 V).
9 to 24	P1D15, P1D14, P1D13, P1D12, P1D11, P1D10, P1D9, P1D8, P1D7, P1D6, P1D5, P1D4, P1D3, P1D2, P1D1, P1D0	Port 1 Data Bit Inputs.
25	DCO	Data Clock Output. Use to clock data source.
26, 30	DNC	Do Not Connect. Do not connect to these pins.
27	DVDD33	Digital Input/Output Supply Voltage (3.3 V).
29	IQSEL	I/Q Framing Signal for Single-Port Mode Operation.
31 to 46	P2D15, P2D14, P2D13, P2D12, P2D11, P2D10, P2D9, P2D8, P2D7, P2D6, P2D5, P2D4, P2D3, P2D2, P2D1, P2D0	Port 2 Data Bit Inputs.
49	SDO	Serial Peripheral Interface Data Output.
50	SDIO	Serial Peripheral Interface Data Input and Optional Data Output.
51	SCLK	Serial Peripheral Interface Clock Input.
52	CSB	Serial Peripheral Interface Chip Select Input. Active low.
53	RESET	Hardware Reset. Active high.
54	FSADJ	Full-Scale Current Output Adjust. Connect a 10 kΩ resistor to AVSS.
55	REFIO	Reference Input/Output. Connect a 0.1 μF capacitor to AVSS.
56, 57, 71, 72	AVDD33	Analog Supply Voltage (3.3 V).
58, 61, 64, 67, 70	AVSS	Analog Supply Common (0 V).

Pin No.	Mnemonic	Description
59	IOUT2P	DAC2 Current Output. Sources full-scale current when input data bits are all 1.
60	IOUT2N	Complementary DAC2 Current Output. Sources full-scale current when data bits are all 0.
62	AUX2P	Auxiliary DAC2 Default Current Output Pin.
63	AUX2N	Auxiliary DAC2 Optional Output Pin. Enable through SPI.
65	AUX1N	Auxiliary DAC1 Optional Output Pin. Enable through SPI.
66	AUX1P	Auxiliary DAC1 Default Current Output Pin.
68	IOUT1N	Complementary DAC1 Current Output. Sources full-scale current when data bits are all 0.
69	IOUT1P	DAC1 Current Output. Sources full-scale current when data bits are all 1.
	EPAD	Exposed Thermal Pad. The exposed thermal pad must be soldered to copper pour on top surface of PCB for mechanical stability and must be electrically tied to low impedance GND plane for low noise performance.

TYPICAL PERFORMANCE CHARACTERISTICS



Figure 6. AD9747 SFDR vs. f_{OUT} , Normal Mode



Figure 9. AD9747 IMD vs. f_{OUT} , Normal Mode

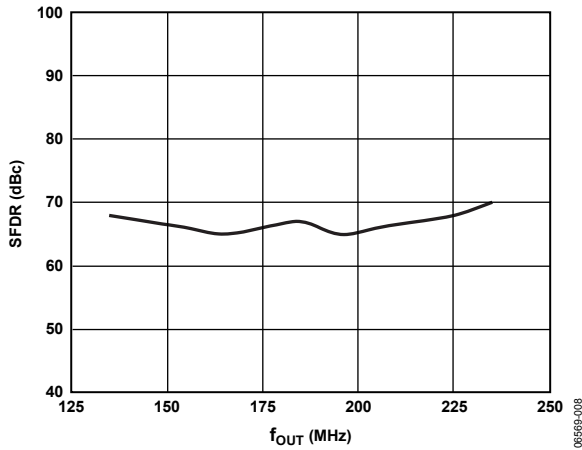

Figure 7. AD9747 SFDR vs. f_{OUT} , Mix Mode, 250 MSPS

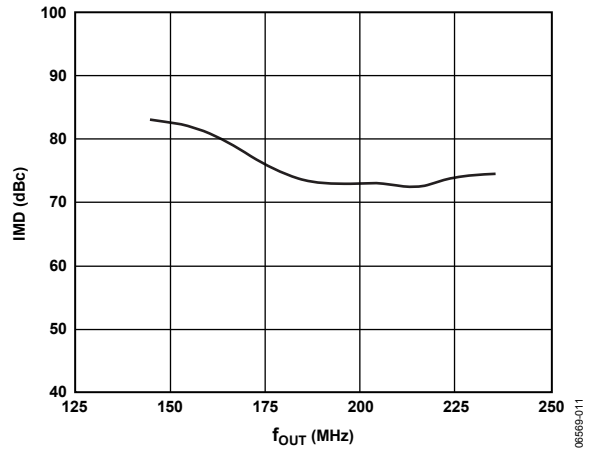

Figure 10. AD9747 IMD vs. f_{OUT} , Mix Mode, 250 MSPS



Figure 8. AD9747 ACLR vs. f_{OUT} , Single Carrier W-CDMA, 245.76 MSPS



Figure 11. AD9747 NSD vs. f_{OUT} , Single Carrier W-CDMA, 245.76 MSPS



Figure 12. AD9747 SFDR vs. Analog Output (f_{OUT}) over Full-Scale Current, 250 MSPS

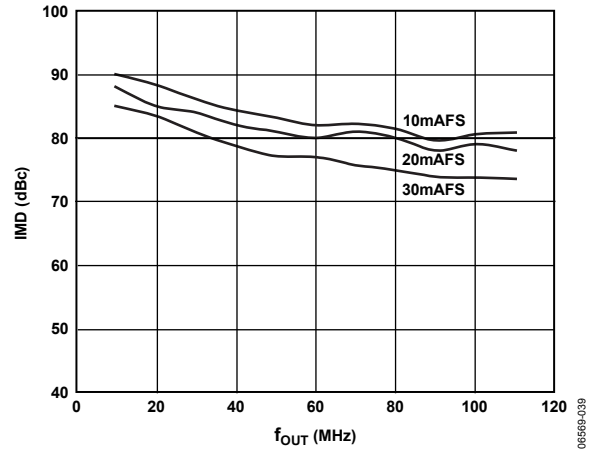

Figure 15. AD9747 IMD vs. Analog Output (f_{OUT}) over Full-Scale Current, 250 MSPS

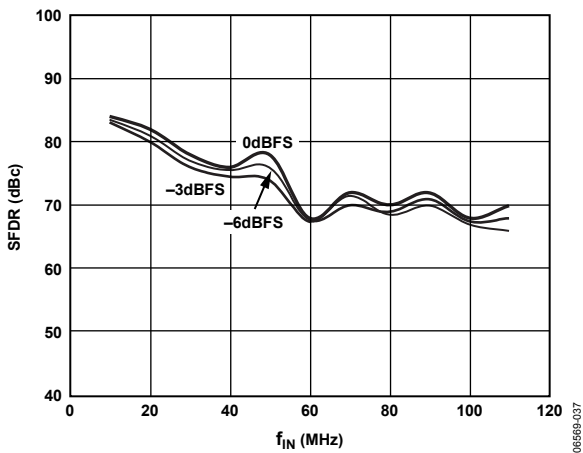

Figure 13. AD9747 SFDR vs. Digital Input (f_{IN}) over Digital Backoff, 250 MSPS

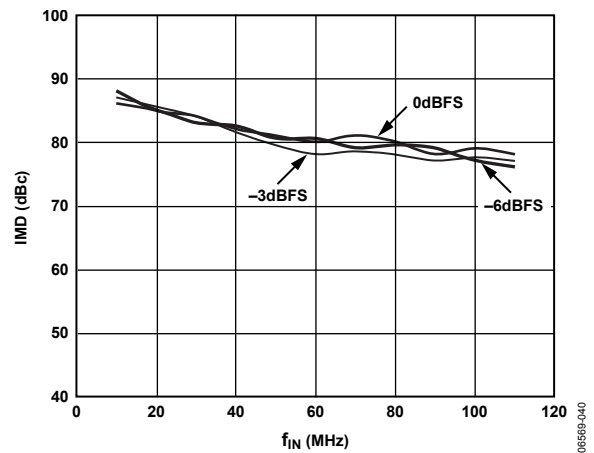

Figure 16. AD9747 IMD vs. Digital Input (f_{IN}) over Digital Backoff, 250 MSPS



Figure 14. AD9747 SFDR vs. f_{OUT} over Input Data Timing

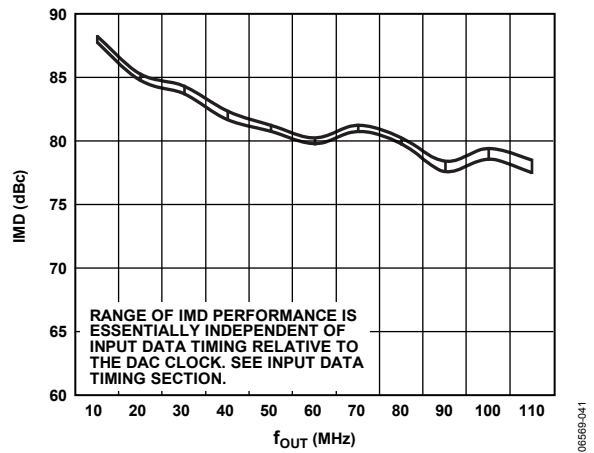

Figure 17. AD9747 IMD vs. f_{OUT} over Input Data Timing

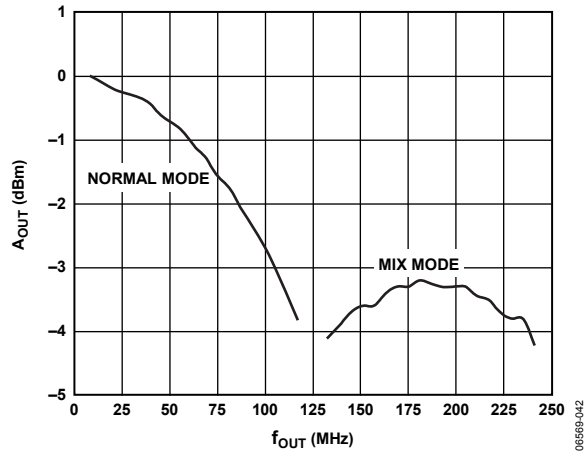

Figure 18. Nominal Power in the Fundamental, $I_{FS} = 20\text{ mA}$

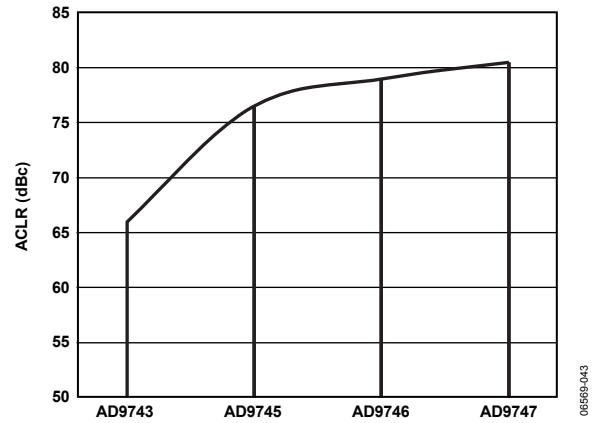

Figure 20. NSD vs. Bit Resolution, Single Carrier W-CDMA, 245.76 MSPS, $f_{CARRIER} = 61.44\text{ MHz}$



Figure 19. ACLR vs. Bit Resolution, Single Carrier W-CDMA, 245.76 MSPS, $f_{CARRIER} = 61.44\text{ MHz}$

TERMINOLOGY

Integral Nonlinearity (INL)

The maximum deviation of the actual analog output from the ideal output, as determined by a straight line drawn from zero scale to full scale.

Differential Nonlinearity (DNL)

A measure of the maximum deviation in analog output associated with any single value change in the digital input code relative to an ideal LSB.

Monotonicity

A DAC is monotonic if the analog output increases or remains constant in response to an increase in the digital input.

Offset Error

The deviation of the output current from the ideal zero-scale current. For differential outputs, 0 mA is expected at I_{OUTP} when all inputs are low, and 0 mA is expected at I_{OUTN} when all inputs are high.

Gain Error

The deviation of the output current from the ideal full-scale current. Actual full-scale output current is determined by subtracting the output (when all inputs are low) from the output (when all inputs are high).

Output Compliance Range

The range of allowable voltage seen by the analog output of a current output DAC. Operation beyond the compliance limits can cause output stage saturation and/or a breakdown resulting in nonlinear performance.

Temperature Drift

The maximum change in a parameter from ambient temperature (25°C) to either T_{MIN} or T_{MAX} , typically reported as ppm/°C.

Spurious-Free Dynamic Range (SFDR)

The difference in decibels between the peak amplitude of a test tone and the peak amplitude of the largest spurious signal over the specified bandwidth.

Intermodulation Distortion (IMD)

The difference in decibels between the maximum peak amplitude of two test tones and the maximum peak amplitude of the distortion products created from the sum or difference of integer multiples of the test tones.

Adjacent Channel Leakage Ratio (ACLR)

The ratio between the measured power of a wideband signal within a channel relative to the measured power in an empty adjacent channel.

Noise Spectral Density (NSD)

The measured noise power over a 1 Hz bandwidth seen at the analog output.

THEORY OF OPERATION

The [AD9743/AD9745/AD9746/AD9747](#) combine many features to make them very attractive for wired and wireless communications systems. The dual DAC architecture facilitates easy interfacing to common quadrature modulators when designing single sideband transmitters. In addition, the speed and performance of the devices allow wider bandwidths and more carriers to be synthesized than in previously available products.

All features and options are software programmable through the SPI port.

SPI PORT

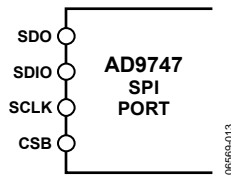

Figure 21. SPI Port

The SPI port is a flexible, synchronous serial communications port allowing easy interfacing to many industry-standard microcontrollers and microprocessors. The port is compatible with most synchronous transfer formats including both the Motorola SPI and Intel® SSR protocols.

The interface allows read and write access to all registers that configure the [AD9743/AD9745/AD9746/AD9747](#). Single or multiple byte transfers are supported as well as MSB-first or LSB-first transfer formats. Accomplish serial data input/output through a single bidirectional pin (SDIO) or through two unidirectional pins (SDIO/SDO).

The serial port configuration is controlled by Register 0x00, Bits[7:6]. It is important to note that any change made to the serial port configuration occurs immediately upon writing to the last bit of this byte. Therefore, it is possible with a multibyte transfer to write to this register and change the configuration in the middle of a communication cycle. Take care to compensate for the new configuration within the remaining bytes of the current communication cycle.

Use of a single-byte transfer when changing the serial port configuration prevents unexpected device behavior.

GENERAL OPERATION OF THE SERIAL INTERFACE

There are two phases to any communication cycle with the [AD9743/AD9745/AD9746/AD9747](#): Phase 1 and Phase 2. Phase 1 is the instruction cycle, which writes an instruction byte into the device. This byte provides the serial port controller with information regarding Phase 2 of the communication cycle: the data transfer cycle.

The Phase 1 instruction byte defines whether the upcoming data transfer is read or write, the number of bytes in the data transfer, and a reference register address for the first byte of the data transfer. A logic high on the CSB pin followed by a logic low

resets the SPI port to its initial state and defines the start of the instruction cycle. From this point, the next eight rising SCLK edges define the eight bits of the instruction byte for the current communication cycle.

The remaining SCLK edges are for Phase 2 of the communication cycle, which is the data transfer between the serial port controller and the system controller. Phase 2 can be a transfer of 1, 2, 3, or 4 data bytes as determined by the instruction byte. Using multibyte transfers is usually preferred although single-byte data transfers are useful to reduce CPU overhead or when only a single register access is required.

All serial port data transfers to and from the device in synchronization with the SCLK pin. Input data always latches on the rising edge of SCLK whereas output data is always valid after the falling edge of SCLK. Register contents change immediately upon writing to the last bit of each transfer byte.

When synchronization is lost, the device has the ability to terminate an input/output operation asynchronously whenever the CSB pin is taken to logic high. Any unwritten register content data is lost if the input/output operation is aborted. Taking CSB low then resets the serial port controller and restarts the communication cycle.

INSTRUCTION BYTE

The instruction byte contains the information shown in the following bit map.

MSB							LSB
B7	B6	B5	B4	B3	B2	B1	B0
R/W	N1	N0	A4	A3	A2	A1	A0

Bit 7, R/W, determines whether a read or a write data transfer occurs after the instruction byte write. Logic high indicates a read operation. Logic 0 indicates a write operation.

Bits[6:5], N1 and N0, determine the number of bytes to be transferred during the data transfer cycle. The bits decode as shown in Table 12.

Table 12. Byte Transfer Count

N1	N0	Description
0	0	Transfer one byte
0	1	Transfer two bytes
1	0	Transfer three bytes
1	1	Transfer four bytes

Bits[4:0], A4, A3, A2, A1, and A0, determine which register is accessed during the data transfer of the communications cycle. For multibyte transfers, this address is a starting or ending address depending on the current data transfer mode. For MSB-first format, the specified address is an ending address or the most significant address in the current cycle. The serial port controller internally generates the remaining register addresses for multiple byte data transfers by decrementing from the

specified address. For LSB-first format, the specified address is a beginning address or the least significant address in the current cycle. The serial port controller internally generates the remaining register addresses for multiple byte data transfers by incrementing from the specified address.

MSB/LSB TRANSFERS

The serial port can support both MSB-first and LSB-first data formats. Register 0x00, Bit 6 controls this functionality. The default is Logic 0, which is MSB-first format.

When using MSB-first format (LSBFIRST = 0), the instruction and data bit must be written from MSB to LSB. Multibyte data transfers in MSB-first format start with an instruction byte that includes the register address of the most significant data byte. Subsequent data bytes are loaded into sequentially lower address locations. In MSB-first mode, the serial port internal address generator decrements for each byte of the multibyte data transfer.

When using LSB-first format (LSBFIRST = 1), the instruction and data bit must be written from LSB to MSB. Multibyte data transfers in LSB-first format start with an instruction byte that includes the register address of the least significant data byte. Subsequent data bytes are loaded into sequentially higher address locations. In LSB-first mode, the serial port internal address generator increments for each byte of the multibyte data transfer.

Use of a single-byte transfer when changing the serial port data format prevents unexpected device behavior.

SERIAL INTERFACE PORT PIN DESCRIPTIONS

Chip Select Bar (CSB)

Active low input starts and gates a communication cycle. It allows more than one device to be used on the same serial communication lines. CSB must stay low during the entire communication cycle. Incomplete data transfers abort anytime the CSB pin goes high. SDO and SDIO pins go to a high impedance state when this input is high.

Serial Clock (SCLK)

The serial clock pin synchronizes data to and from the device and runs the internal state machines. The maximum frequency of SCLK is 40 MHz. All data input is registered on the rising edge of SCLK. All data is driven out on the falling edge of SCLK.

Serial Data Input/Output (SDIO)

Data is always written into the device on this pin. However, SDIO can also function as a bidirectional data output line. Register 0x00, Bit 7 controls the configuration of this pin. The default is Logic 0, which configures the SDIO pin as unidirectional.

Serial Data Out (SDO)

Data is read from this pin for protocols that use separate lines for transmitting and receiving data. Register 0x00, Bit 7 controls the configuration of this pin. If this bit is set to a Logic 1, the SDO pin does not output data and is set to a high impedance state.

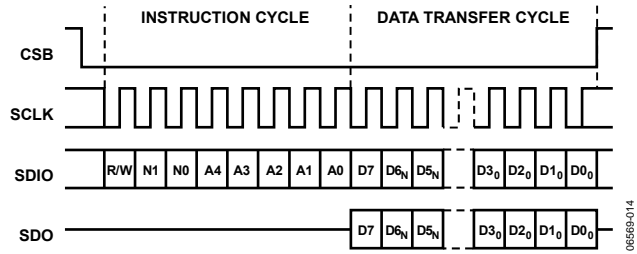

Figure 22. Serial Register Interface Timing—MSB First

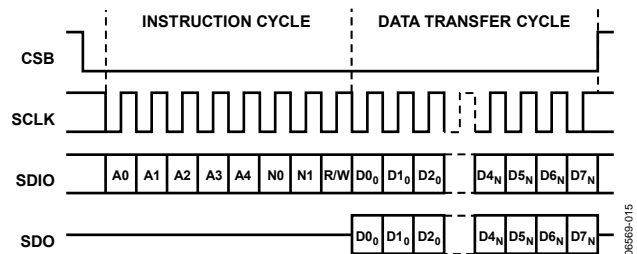

Figure 23. Serial Register Interface Timing—LSB First

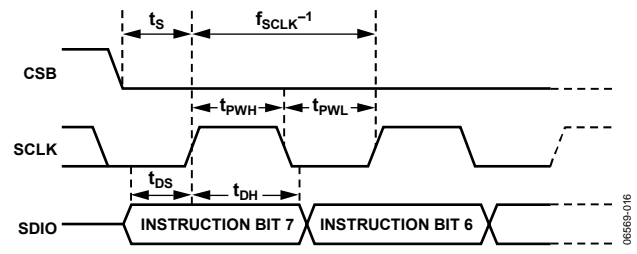

Figure 24. Timing Diagram for SPI Register Write

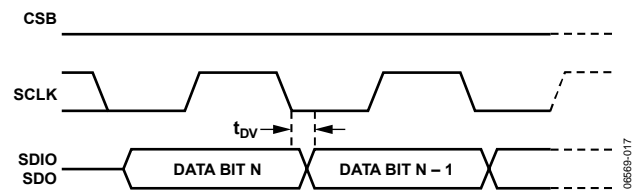

Figure 25. Timing Diagram for SPI Register Read

SPI REGISTER MAP

Reading any register returns previously written values for all defined register bits, unless otherwise noted. Change serial port configuration or execute software reset in single byte instruction only to avoid unexpected device behavior.

Table 13.

Register Name	Address	Default	Bit 7	Bit 6	Bit 5	Bit 4	Bit 3	Bit 2	Bit 1	Bit 0
SPI Control	0x00	0x00	SDIODIR	LSBFIRST	SWRESET					
Data Control	0x02	0x00	DATTYPE	ONEPORT		INVDCO				
Power Down	0x03	0x00	PD_DCO		PD_AUX2	PD_AUX1	PD_BIAS	PC_CLK	PD_DAC2	PD_DAC1
DAC Mode Select	0x0A	0x00					DAC1MOD[1:0]		DAC2MOD[1:0]	
DAC1 Gain LSB	0x0B	0xF9	DAC1FSC[7:0]							
DAC1 Gain MSB	0x0C	0x01							DAC1FSC[9:8]	
AUX DAC1 LSB	0x0D	0x00	AUXDAC1[7:0]							
AUX DAC1 MSB	0x0E	0x00	AUX1PIN	AUX1DIR					AUXDAC1[9:8]	
DAC2 Gain LSB	0x0F	0xF9	DAC2FSC[7:0]							
DAC2 Gain MSB	0x10	0x01							DAC2FSC[9:8]	
AUX DAC2 LSB	0x11	0x00	AUXDAC2[7:0]							
AUX DAC2 MSB	0x12	0x00	AUX2PIN	AUX2DIR					AUXDAC2[9:8]	

SPI REGISTER DESCRIPTIONS

Table 14.

Register	Address	Bit	Name	Description
SPI Control	0x00	7	SDIODIR	0 = operate SPI in 4-wire mode, SDIO pin operates as an input only 1 = operate SPI in 3-wire mode, SDIO pin operates as a bidirectional input/output line
		6	LSBFIRST	0 = LSBFIRST off, SPI serial data mode is MSB to LSB 1 = LSBFIRST on, SPI serial data mode is LSB to MSB
		5	SWRESET	0 = resume normal operation following software RESET 1 = software RESET; loads default values to all registers (except Register 0x00)
Data Control	0x02	7	DATYPE	0 = DAC input data is twos complement binary format 1 = DAC input data is unsigned binary format
		6	ONEPORT	0 = normal dual-port input mode 1 = optional single port input mode, interleaved data received on Port 1 only
		4	INVDCO	1 = inverts data clock output signal
Power Down	0x03	7	PD_DCO	1 = power down data clock output
		5	PD_AUX2	1 = power down AUX2 DAC
		4	PD_AUX1	1 = power down AUX1 DAC
		3	PD_BIAS	1 = power down reference voltage bias circuit
		2	PD_CLK	1 = power down DAC clock input circuit
		1	PD_DAC2	1 = power down DAC2 analog output
		0	PD_DAC1	1 = power down DAC1 analog output
DAC Mode Select	0x0A	3:2	DAC1MOD[1:0]	00 = selects normal mode, DAC1 01 = selects mix mode, DAC1 10 = selects return to zero mode, DAC1
		1:0	DAC2MOD[1:0]	00 = selects normal mode, DAC2 01 = selects mix mode, DAC2 10 = selects return to zero mode, DAC2
DAC1 Gain	0x0B	7:0	DAC1FSC[7:0]	DAC1 full-scale 10-bit adjustment word
	0x0C	1:0	DAC1FSC[9:8]	0x03FF = sets full-scale current to the maximum value of 31.66 mA 0x01F9 = sets full-scale current to the nominal value of 20.0 mA 0x0000 = sets full-scale current to the minimum value of 8.64 mA
AUX DAC1	0x0D	7:0	AUXDAC1[7:0]	Auxiliary DAC1 10-bit output current adjustment word
	0x0E	1:0	AUXDAC1[9:8]	0x03FF = sets output current magnitude to 2.0 mA 0x0200 = sets output current magnitude to 1.0 mA 0x0000 = sets output current magnitude to 0.0 mA
		7	AUX1PIN	1 = AUX1P output pin is active 0 = AUX1N output pin is active
	6	AUX1DIR	0 = configures AUX1 DAC output to source current 1 = configures AUX1 DAC output to sink current	
DAC2 Gain	0x0F	7:0	DAC2FSC[7:0]	DAC2 full-scale 10-bit adjustment word
	0x10	1:0	DAC2FSC[9:8]	0x03FF = sets full-scale current to the maximum value of 31.66 mA 0x01F9 = sets full-scale current to the nominal value of 20.0 mA 0x0000 = sets full-scale current to the minimum value of 8.64 mA
AUX DAC2	0x11	7:0	AUXDAC2[7:0]	Auxiliary DAC2 10-bit output current adjustment word
	0x12	1:0	AUXDAC2[9:8]	0x03FF = sets output current magnitude to 2.0 mA 0x0200 = sets output current to 1.0 mA 0x0000 = sets output current to 0.0 mA
		7	AUX2PIN	1 = AUX2P output pin is active 0 = AUX2N output pin is active
	6	AUX2DIR	0 = configures AUX2 DAC output to source current 1 = configures AUX2 DAC output to sink current	

DIGITAL INPUTS AND OUTPUTS

The AD9743/AD9745/AD9746/AD9747 can operate in two data input modes: dual-port mode and single-port mode. For the default dual-port mode (ONEPORT = 0), each DAC receives data from a dedicated input port. In single-port mode (ONEPORT = 1), however, both DACs receive data from Port 1. In single-port mode, DAC1 and DAC2 data is interleaved and the IQSEL input steers data to the correct DAC.

In single-port mode, when the IQSEL input is high, Port 1 data is delivered to DAC1 and when IQSEL is low, Port 1 data is delivered to DAC2. The IQSEL input must always coincide and be time-aligned with the other data bus signals. In single-port mode, minimum setup and hold times apply to the IQSEL input as well as to the input data signals. In dual-port mode, the IQSEL input is ignored.

In dual-port mode, the data must be delivered at the sample rate (up to 250 MSPS). In single-port mode, data must be delivered at twice the sample rate. Because the data inputs function only up to 250 MSPS, it is only practical to operate the DAC clock at up to 125 MHz in single-port mode.

In both dual-port and single-port modes, a data clock output (DCO) signal is available as a fixed time base with which to stimulate data from an FPGA. This output signal always operates at the sample rate. It can be inverted by asserting the INVDCO bit.

INPUT DATA TIMING

With most DACs, signal-to-noise ratio (SNR) is a function of the relationship between the position of the clock edges and the point in time at which the input data changes. The AD9743/AD9745/AD9746/AD9747 are rising edge triggered and thus exhibit greater SNR sensitivity when the data transition is close to this edge.

The specified minimum setup and hold times define a window of time, within each data period, where the data is sampled correctly. Users must position data to arrive relative to the DAC clock and well beyond the minimum setup and minimum hold times. This becomes increasingly more important at increasingly higher sample rates.

DUAL-PORT MODE TIMING

Figure 26 shows the timing diagram for the dual-port mode.

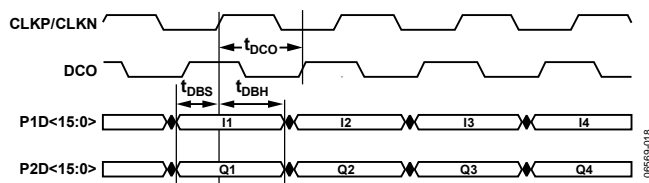

Figure 26. Data Interface Timing, Dual-Port Mode

In Figure 26, data samples for DAC1 are labeled Ix and data samples for DAC2 are labeled Qx. Note that the differential DAC clock input is shown in a logical sense (CLKP/CLKN). The data clock output is labeled DCO.

Setup and hold times are referenced to the positive transition of the DAC clock. Data must arrive at the input pins such that the minimum setup and hold times are met. Note that the data clock output has a fixed time delay from the DAC clock and may be a more convenient signal to use to confirm timing.

SINGLE-PORT MODE TIMING

Figure 27 shows the single-port mode timing diagram.



Figure 27. Data Interface Timing, Single-Port Mode

In single-port mode, data for both DACs is received on the Port 1 input bus. Ix and Qx data samples are interleaved and arrive twice as fast as in dual-port mode. Accompanying the data is the IQSEL input signal, which steers incoming data to its respective DAC. When IQSEL is high, data is steered to DAC1 and when IQSEL is low, data is steered to DAC2. IQSEL must coincide as well as be time-aligned with incoming data.

SPI PORT, RESET, AND PIN MODE

In general, when the AD9743/AD9745/AD9746/AD9747 power up, an active high pulse applied to the RESET pin follows. This ensures the default state of all control register bits. In addition, once the RESET pin goes low, the SPI port can activate, so CSB must be held high.

For applications without a controller, the AD9743/AD9745/AD9746/AD9747 also support pin mode operation, which allows some functional options to be pin, selected without the use of the SPI port. Pin mode is enabled anytime the RESET pin is held high. In pin mode, the four SPI port pins take on secondary functions, as shown in Table 15.

Table 15. SPI Pin Functions (Pin Mode)

Pin Name	Pin Mode Description
SCLK	ONEPORT (Register 0x02, Bit 6), bit value (1/0) equals pin state (high/low)
SDIO	DATYPE (Register 0x02, Bit 7), bit value (1/0) equals pin state (high/low)
CSB	Enable mix mode, if CSB is high, Register 0x0A is set to 0x05 putting both DAC1 and DAC2 into mix mode
SDO	Enable full power-down, if SDO is high, Register 0x03 is set to 0xFF

In pin mode, all register bits reset to their default values with the exception of those controlled by the SPI pins.

Note also that the RESET pin must be allowed to float and must be pulled low. Connect an external 10 kΩ resistor to DVSS. This avoids unexpected behavior in noisy environments.

DRIVING THE DAC CLOCK INPUT

The DAC clock input requires a low jitter drive signal. It is a PMOS differential pair powered from the CVDD18 supply. Each pin can safely swing up to 800 mV p-p at a common-mode voltage of about 400 mV. Though these levels are not directly LVDS-compatible, CLKP and CLKN can be driven by an ac-coupled, dc-offset LVDS signal, as shown in Figure 28.

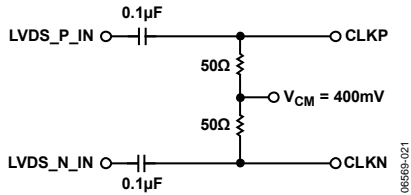

Figure 28. LVDS DAC Clock Drive Circuit

Using a CMOS or TTL clock is also acceptable for lower sample rates. It can be routed through an LVDS translator and then ac-coupled as described previously, or alternatively, it can be transformer-coupled and clamped, as shown in Figure 29.

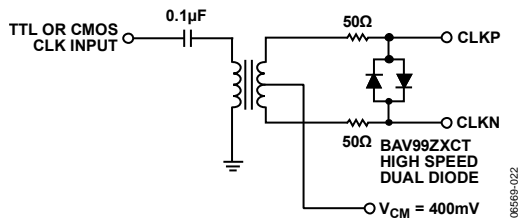

Figure 29. TTL or CMOS DAC Clock Drive Circuit

If a sine wave signal is available, it can be transformer-coupled directly to the DAC clock inputs, as shown in Figure 30.



Figure 30. Sine Wave DAC Clock Drive Circuit

The 400 mV common-mode bias voltage can be derived from the CVDD18 supply through a simple divider network, as shown in Figure 31.



Figure 31. DAC Clock VCM Circuit

It is important to use CVDD18 and CVSS for any clock bias circuit as noise that is coupled onto the clock from another power supply is multiplied by the DAC input signal and degrades performance.

FULL-SCALE CURRENT GENERATION

The full-scale currents on DAC1 and DAC2 are functions of the current drawn through an external resistor connected to the FSADJ pin (Pin 54). The required value for this resistor is 10 kΩ. An internal amplifier sets the current through the resistor to force a voltage equal to the band gap voltage of 1.2 V. This develops a reference current in the resistor of 120 μA.

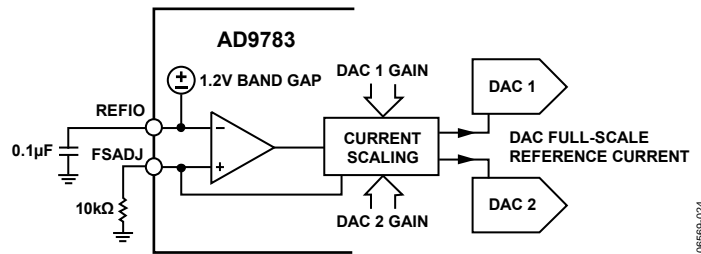

Figure 32. Reference Circuitry

REFIO (Pin 55) must be bypassed to ground with a 0.1 μF capacitor. The band gap voltage is present on this pin and can be buffered for use in external circuitry. The typical output impedance is near 5 kΩ. If desired, connect an external reference to REFIO to overdrive the internal reference.

Internal current mirrors provide a means for adjusting the DAC full-scale currents. The gain for DAC1 and DAC2 can be adjusted independently by writing to the DAC1FSC[9:0] and DAC2FSC[9:0] register bits. The default value of 0x01F9 for the DAC gain registers gives an I_{FS} of 20 mA, where I_{FS} equals

$$I_{FS} = \frac{1.2 \text{ V}}{10,000} \times \left(72 + \left(\frac{3}{16} \times \text{DACn FSC} \right) \right)$$

The full-scale output current range is 8.6 mA to 31.7 mA for register values 0x000 to 0x3FF.



Figure 33. I_{FS} vs. DAC Gain Code

DAC TRANSFER FUNCTION

Each DAC output of the AD9743/AD9745/AD9746/AD9747 drives complementary current outputs I_{OUTP} and I_{OUTN} . I_{OUTP} provides a near full-scale current output (I_{FS}) when all bits are high. For example,

$$DAC\ CODE = 2^N - 1$$

where:

$N = 10\text{-}/12\text{-}/14\text{-}/16\text{-bits}$ (for AD9743/AD9745/AD9746/AD9747 respectively), and I_{OUTN} provides no current.

The current output appearing at I_{OUTP} and I_{OUTN} is a function of both the input code and I_{FS} and can be expressed as

$$I_{OUTP} = (DAC\ DATA/2^N) \times I_{FS} \tag{1}$$

$$I_{OUTN} = ((2^N - 1) - DAC\ DATA)/2^N \times I_{FS} \tag{2}$$

where $DAC\ DATA = 0$ to $2^N - 1$ (decimal representation).

The two current outputs typically drive a resistive load directly or via a transformer. If dc coupling is required, I_{OUTP} and I_{OUTN} must be connected to matching resistive loads (R_{LOAD}) that are tied to analog common (AVSS). The single-ended voltage output appearing at the I_{OUTP} and I_{OUTN} pins is

$$V_{OUTP} = I_{OUTP} \times R_{LOAD} \tag{3}$$

$$V_{OUTN} = I_{OUTN} \times R_{LOAD} \tag{4}$$

To achieve the maximum output compliance of 1 V at the nominal 20 mA output current, R_{LOAD} must be set to 50 Ω . The full-scale value of V_{OUTP} and V_{OUTN} must not exceed the specified output compliance range to maintain specified distortion and linearity performance.

There are two distinct advantages to operating the AD9743/AD9745/AD9746/AD9747 differentially. First, differential operation helps cancel common-mode error sources associated with I_{OUTP} and I_{OUTN} , such as noise, distortion, and dc offsets. Second, the differential code dependent current and subsequent output voltage (V_{DIFF}) is twice the value of the single-ended voltage output (V_{OUTP} or V_{OUTN}), providing 2x signal power to the load.

$$V_{DIFF} = (I_{OUTP} - I_{OUTN}) \times R_{LOAD} \tag{5}$$

ANALOG MODES OF OPERATION

The AD9743/AD9745/AD9746/AD9747 use a proprietary quad-switch architecture that lowers the distortion of the DAC output by eliminating a code dependent glitch that occurs with conventional dual-switch architectures. Although this architecture eliminates the code dependent glitches, it creates a constant glitch at a rate of $2 \times f_{DAC}$. For communications systems and other applications requiring good frequency domain performance, this is seldom problematic.

The quad-switch architecture also supports two additional modes of operation; mix mode and return-to-zero (RZ) mode. Figure 34 shows the waveforms of these two modes. In mix mode, the output is inverted every other half clock cycle. This effectively chops the DAC output at the sample rate. This chopping has the

effect of frequency shifting the sinc roll-off from dc to f_{DAC} . Additionally, there is a second subtle effect on the output spectrum. The shifted spectrum is shaped by a second sinc function with a first null at $2 \times f_{DAC}$. This shaping occurs because the data is not continuously varying at twice the clock rate, but rather simply repeats.

In RZ mode, the output is set to midscale on every other half clock cycle. The output is similar to the DAC output in normal mode except that the output pulses are half the width and half the area. Because the output pulses have half the width, the sinc function is scaled in frequency by 2 and has a first null at $2 \times f_{DAC}$. Because the area of the pulses is half that of the pulses in normal mode, the output power is half the normal mode output power.



Figure 34. Mix Mode and RZ Mode DAC Waveforms

Figure 35 shows the functions that shape the output spectrums for normal mode, mix mode, and RZ mode. Switching between the modes reshapes the sinc roll off inherent at the DAC output. This ability to change modes in the AD9743/AD9745/AD9746/AD9747 makes the parts suitable for direct IF applications. The user can place a carrier anywhere in the first three Nyquist zones depending on the operating mode selected. The performance and maximum amplitude in all three zones are impacted by this sinc roll off depending on the placement of the carrier (see Figure 35).



Figure 35. Transfer Function for Each Analog Operating Mode

AUXILIARY DACS

Two auxiliary DACs are provided on the AD9743/AD9745/AD9746/AD9747. Figure 36 shows a functional diagram. The auxiliary DACs are current output devices with two output pins, AUXP and AUXN. The active pin can be programmed to either source or sink current. When either sinking or sourcing, the full-scale current magnitude is 2 mA. The available compliance range at the auxiliary DAC outputs depends on whether the output is configured to a sink or source current. When sourcing current, the compliance voltage is 0 V to 1.6 V, but when sinking current, the output compliance voltage reduces to 0.8 V to 1.6 V. Either output can be used, but only one output of the auxiliary DAC (P or N) is active at any time. The inactive pin is always in a high impedance state (>100 kΩ).



Figure 36. Auxiliary DAC Functional Diagram

In a single side band transmitter application, the combination of the input referred dc offset voltage of the quadrature modulator and the DAC output offset voltage can result in local oscillator (LO) feedthrough at the modulator output, which degrades system performance. The auxiliary DACs can remove the dc offset and the resulting LO feedthrough. The circuit configuration for using the auxiliary DACs for performing dc offset correction depends on the details of the DAC and modulator interface. The Power Dissipation section outlines an example of a dc-coupled configuration with low-pass filtering.



Figure 37. DAC DC Coupled to Quadrature Modulator with Passive DC Shift

POWER DISSIPATION

Figure 38 shows the power dissipation and current draw of the AD9743/AD9745/AD9746/AD9747. It shows that the devices have a quiescent power dissipation of about 190 mW. Most of this comes from the AVDD33 supply. Total power dissipation increases about 50% as the clock rate increases to the maximum clock rate of 250 MHz.



Figure 38. AD9747 Power Dissipation vs. f_{DAC}



Figure 39. DVDD33 Current vs. f_{DAC}



Figure 40. DVDD18 Current vs. f_{DAC}

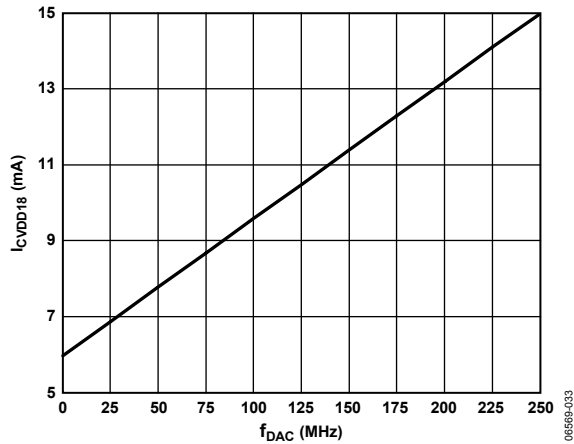

Figure 41. CVDD18 Current vs. f_{DAC}

Figure 42 shows the power consumption for each power supply domain as well as the total power consumption. Individual bars within each group display the power in full active mode (blue) vs. power for five increasing levels of power-down.

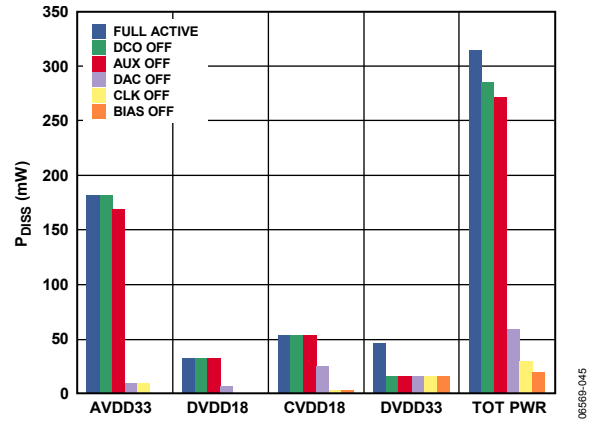

Figure 42. Power Dissipation vs. Power-Down Mode

AVDD33 dominates the overall power consumption and significant power savings can be achieved simply by disabling the DAC outputs. In addition, disabling the DAC outputs is a significant way to conserve power and still maintain a fast wake-up time. Full power-down disables all circuitry for minimum power consumption. Note, however, that even in full power-down, there is a small power draw (25 mW) due to incoming data activity. To lower power consumption to near zero, halt all incoming data activity.

OUTLINE DIMENSIONS



COMPLIANT TO JEDEC STANDARDS MO-220-VNND-4

Figure 43. 72-Lead Lead Frame Chip Scale Package [LFCSP_VQ]
 10 mm x 10 mm, Very Thin Quad
 (CP-72-1)
 Dimensions shown in millimeters

06-15-2012-A

ORDERING GUIDE

Model ¹	Temperature Range	Package Description	Package Option
AD9743BCPZ	-40°C to +85°C	72-Lead Lead Frame Chip Scale Package [LFCSP_VQ]	CP-72-1
AD9743BCPZRL	-40°C to +85°C	72-Lead Lead Frame Chip Scale Package [LFCSP_VQ]	CP-72-1
AD9745BCPZ	-40°C to +85°C	72-Lead Lead Frame Chip Scale Package [LFCSP_VQ]	CP-72-1
AD9745BCPZRL	-40°C to +85°C	72-Lead Lead Frame Chip Scale Package [LFCSP_VQ]	CP-72-1
AD9746BCPZ	-40°C to +85°C	72-Lead Lead Frame Chip Scale Package [LFCSP_VQ]	CP-72-1
AD9746BCPZRL	-40°C to +85°C	72-Lead Lead Frame Chip Scale Package [LFCSP_VQ]	CP-72-1
AD9747BCPZ	-40°C to +85°C	72-Lead Lead Frame Chip Scale Package [LFCSP_VQ]	CP-72-1
AD9747BCPZRL	-40°C to +85°C	72-Lead Lead Frame Chip Scale Package [LFCSP_VQ]	CP-72-1
AD9743-DPG2-EBZ		Evaluation Board	
AD9745-DPG2-EBZ		Evaluation Board	
AD9746-DPG2-EBZ		Evaluation Board	
AD9747-DPG2-EBZ		Evaluation Board	

¹ Z = RoHS Compliant Part.

Компания «Океан Электроники» предлагает заключение долгосрочных отношений при поставках импортных электронных компонентов на взаимовыгодных условиях!

Наши преимущества:

- Поставка оригинальных импортных электронных компонентов напрямую с производств Америки, Европы и Азии, а так же с крупнейших складов мира;
- Широкая линейка поставок активных и пассивных импортных электронных компонентов (более 30 млн. наименований);
- Поставка сложных, дефицитных, либо снятых с производства позиций;
- Оперативные сроки поставки под заказ (от 5 рабочих дней);
- Экспресс доставка в любую точку России;
- Помощь Конструкторского Отдела и консультации квалифицированных инженеров;
- Техническая поддержка проекта, помощь в подборе аналогов, поставка прототипов;
- Поставка электронных компонентов под контролем ВП;
- Система менеджмента качества сертифицирована по Международному стандарту ISO 9001;
- При необходимости вся продукция военного и аэрокосмического назначения проходит испытания и сертификацию в лаборатории (по согласованию с заказчиком);
- Поставка специализированных компонентов военного и аэрокосмического уровня качества (Xilinx, Altera, Analog Devices, Intersil, Interpoint, Microsemi, Actel, Aeroflex, Peregrine, VPT, Syfer, Eurofarad, Texas Instruments, MS Kennedy, Miteq, Cobham, E2V, MA-COM, Hittite, Mini-Circuits, General Dynamics и др.);

Компания «Океан Электроники» является официальным дистрибьютором и эксклюзивным представителем в России одного из крупнейших производителей разъемов военного и аэрокосмического назначения «JONHON», а так же официальным дистрибьютором и эксклюзивным представителем в России производителя высокотехнологичных и надежных решений для передачи СВЧ сигналов «FORSTAR».



JONHON

«JONHON» (основан в 1970 г.)

Разъемы специального, военного и аэрокосмического назначения:

(Применяются в военной, авиационной, аэрокосмической, морской, железнодорожной, горно- и нефтедобывающей отраслях промышленности)

«FORSTAR» (основан в 1998 г.)

ВЧ соединители, коаксиальные кабели, кабельные сборки и микроволновые компоненты:

(Применяются в телекоммуникациях гражданского и специального назначения, в средствах связи, РЛС, а так же военной, авиационной и аэрокосмической отраслях промышленности).



Телефон: 8 (812) 309-75-97 (многоканальный)

Факс: 8 (812) 320-03-32

Электронная почта: ocean@oceanchips.ru

Web: <http://oceanchips.ru/>

Адрес: 198099, г. Санкт-Петербург, ул. Калинина, д. 2, корп. 4, лит. А